

**Environmental Influences on the Curling of Concrete Slabs at the
Palmdale HVS Test Site**

By:

Louw du Plessis,
CSIR Transportek

John Harvey,
UC Pavement Research Center

Prepared By:

CSIR Transportek
PO Box 395
Pretoria

For the California Department of Transportation

Under the auspices of:

Pavement Research Center
Institute of Transportation Studies
University of California

June 2003

TABLE OF CONTENTS

Table of Contents	iii
List of Tables	vii
List of Figures	xi
1.0 Introduction.....	1
2.0 Test Objectives.....	3
3.0 Test Program.....	5
3.1 Instrumentation and General Layout.....	7
3.1.1 Joint Deflection Measuring Device (JDMD).....	7
3.1.2 Multi-Depth Deflectometer (MDD).....	7
3.1.3 Strain Gauges	8
3.1.4 Thermocouples.....	10
3.2 Data Collection Schedule	10
3.3 Slab Geometry	11
4.0 Results.....	21
4.1 Concrete Curling Modes.....	21
4.2 Assumptions Regarding Warping Caused by Differential Shrinkage.....	23
4.3 Explanation of Terms For Temperature and Slab Thermal Effects.....	25
4.3.1 Temperature Differential and Curl Measurement.....	25
4.3.2 Temperature Change and Joint Opening/Closing Measurement	25
4.3.3 Sign Convention.....	26
4.4 Test 534FD	26
4.4.1 JDMD data	27
4.4.2 MDD data.....	34

4.4.3	Strain Data	35
4.5	Test 535FD	41
4.5.1	JDMD data	41
4.5.2	MDD data.....	49
4.5.3	Strain data	52
4.6	Test 536FD	55
4.6.1	JDMD data	55
4.6.2	MDD data.....	61
4.6.3	Strain data	64
4.7	Test 537FD	69
4.7.1	JDMD Data	69
4.7.2	MDD Data.....	75
4.8	Test 538FD	78
4.8.1	JDMD Data	78
4.9	Test 539FD	82
4.9.1	JDMD data	82
4.9.2	MDD data.....	88
4.10	Test 540FD	90
4.10.1	JDMD data	90
4.10.2	MDD data.....	96
4.11	Test 541FD	98
4.11.1	JDMD Data	98
5.0	Discussion of the JDMD results	103

5.1	General Response of the Test Sections.....	103
5.2	Temperature-induced Movements on the Test Sections.....	114
5.2.1	Design Section 7: No Dowels, Asphalt Shoulder (Tests 534FD and 535FD).....	115
5.2.2	Design Section 9: dowels, tied concrete shoulder (Tests 536FD to 538FD).....	118
5.2.3	Design Section 11: Dowels, Asphalt Shoulder, Wider Slab (Tests 539FD to 541FD).....	123
5.2.4	Summary.....	127
5.3	Transfer of Movements across Joints	129
5.4	Summary of Vertical and Horizontal Movements.....	133
6.0	Conclusions.....	139
6.1	Summary.....	139
6.2	Conclusions	140
7.0	References.....	142

LIST OF TABLES

Table 1.1 Test Section Details, North Tangent	2
Table 3.1 Location and Start Times of Each Test	5
Table 3.2 Test Slab Details and Instrumentation	20
Table 4.1 Summary of JDMD Results at Section 534FD (no HVS, no Temperature Control Chamber).....	30
Table 4.2 Section 534FD Summary of JDMD Results (with HVS, without Temperature Control Chamber).....	32
Table 4.3 Section 534FD Summary of JDMD Results (with HVS and Temperature Control Chamber).....	33
Table 4.4 Section 534FD Summary of all JDMD Results	34
Table 4.5 Section 534FD Summary of MDD Results.....	37
Table 4.6 Section 534FD Summary of Strain Gauge Measurements.....	40
Table 4.7 Section 535FD Summary of JDMD Results (no HVS, no Temperature Control Chamber).....	42
Table 4.8 Section 535FD Summary of JDMD Results (with HVS, without Temperature Control Chamber).....	43
Table 4.9 Section 535FD Summary of JDMD Results (with HVS and Temperature Control Chamber).....	44
Table 4.10 Section 535FD Summary of All JDMD Results.....	48
Table 4.11 Section 535FD Summary of MDD Results	51
Table 4.12 Section 536FD Summary of JDMD Results (no HVS, no Temperature Control Chamber).....	56

Table 4.13 Section 536FD Summary of JDMD Results (with HVS, without Temperature Control Chamber)	57
Table 4.14 Section 536FD Summary of JDMD Results (with HVS and Temperature Control Chamber).....	58
Table 4.15 Section 536FD Summary of all JDMD Results	60
Table 4.16: Section 536FD Summary of MDD Results	62
Table 4.17 Section 536FD Summary of Strain Gauge Results.....	68
Table 4.18: Section 537FD Summary of JDMD Results (no HVS, no Temperature Control Chamber).....	70
Table 4.19: Section 537FD Summary of JDMD Results (with HVS, without Temperature Control Chamber)	71
Table 4.20: Section 537FD Summary of JDMD Results (with HVS and Temperature Control Chamber).....	72
Table 4.21 Section 537FD Summary of JDMD Results.....	74
Table 4.22 Section 537FD Summary of MDD Results	76
Table 4.23: Section 538FD Summary of JDMD Results (no HVS, no Temperature Control Chamber).....	79
Table 4.24 Section 538FD Summary of JDMD Results (with HVS, without Temperature Control Chamber)	80
Table 4.25 Section 538FD Summary of JDMD Results.....	82
Table 4.26: Section 539FD Summary of JDMD Results (no HVS, no Temperature Control Chamber).....	83

Table 4.27 Section 539FD Summary of JDMD Results (with HVS, without Temperature Control Chamber)	84
Table 4.28 Section 539FD Summary of JDMD Results (with HVS and Temperature Control Chamber).....	85
Table 4.29 Section 539FD Summary of JDMD Results	87
Table 4.30 Section 539FD Summary of MDD Results	88
Table 4.31 Section 540FD Summary of JDMD Results (no HVS, no Temperature Control Chamber).....	91
Table 4.32 Section 540FD Summary of JDMD Results (with HVS, without Temperature Control Chamber)	92
Table 4.33 Section 540FD Summary of JDMD Results (with HVS and Temperature Control Chamber).....	93
Table 4.34 Section 540FD Summary of JDMD Results	95
Table 4.35 Section 540FD Summary of MDD Results	96
Table 4.36 Section 541FD Summary of JDMD Results (no HVS, no Temperature Control Chamber).....	99
Table 4.37 Section 541FD Summary of JDMD Results (with HVS, without Temperature Control Chamber)	100
Table 4.38 Section 541FD Summary of JDMD Results.....	102
Table 5.1 Comparison of Nominal Rates of Movement (mm per 10°C) Based on Surface Temperatures.....	128
Table 5.2 Summary of Vertical Surface Movements for All Test Sections.....	134
Table 5.3 Summary of Horizontal Movements for All Test Sections.....	135

Table 5.4 Abbreviated Summary of Vertical Movements for All Test Sections, Temperature

Normalized..... 135

Table 5.5 Abbreviated Summary of Horizontal Movements for All Test Sections, Temperature

Normalized..... 136

LIST OF FIGURES

Figure 1.1. HVS with temperature control chamber at the Palmdale test sections.....	2
Figure 3.1. Placement of JDMD instruments with respect to the test sections.....	8
Figure 3.2. Placement of strain gauges.	9
Figure 3.3. Instrumentation layout of Test Section 534FD.	12
Figure 3.4. Instrumentation layout of Test Section 535FD.	13
Figure 3.5. Instrumentation layout of Test Section 536FD.	14
Figure 3.6. Instrumentation layout of Test Section 537FD.	15
Figure 3.7. Instrumentation layout of Test Section 538FD.	16
Figure 3.8. Instrumentation layout of Test Section 539FD.	17
Figure 3.9. Instrumentation layout of Test Section 540FD.	18
Figure 3.10. Instrumentation layout of Test Section 541FD.	19
Figure 4.1. Edge and corner curling caused by daily temperature variation.	22
Figure 4.2. Horizontal movement at transverse joints caused by daily temperature variation....	22
Figure 4.3. Section 534FD JDMD results (no HVS, no temperature control chamber).....	28
Figure 4.4. Section 534FD JDMD results (with HVS, no temperature control chamber).....	28
Figure 4.5. Section 534FD JDMD results (with HVS and temperature control chamber).....	29
Figure 4.6. Section 534FD lag time when temperature control chamber is used.	29
Figure 4.7. Section 534FD MDD results (no HVS, no temperature control chamber).	36
Figure 4.8. Section 534FD MDD results (with HVS, no temperature control chamber)	36
Figure 4.9. Section 534FD MDD results (with HVS and temperature control chamber).	37
Figure 4.10. Section 534FD strain response (no HVS, no temperature control chamber).	38
Figure 4.11. Section 534FD strain response (with HVS, no the temperature control chamber).	39
Figure 4.12. Section 534FD strain response (with HVS and temperature control chamber).	39

Figure 4.13. Section 535FD JDMD results (no HVS, no temperature control chamber).....	45
Figure 4.14. Section 535FD JDMD results (with HVS, no temperature control chamber).....	45
Figure 4.15. Section 535FD JDMD results (with HVS and temperature control chamber).....	46
Figure 4.16. Section 535FD MDD results (no HVS, no temperature control chamber).	50
Figure 4.17. Section 535FD MDD results (with HVS, no temperature control chamber).	50
Figure 4.18. Section 535FD MDD results (with HVS and temperature control chamber).	51
Figure 4.19. Section 535FD strain response (no HVS, no temperature control chamber).	53
Figure 4.20. Section 535FD strain response (with HVS, no temperature control chamber).	53
Figure 4.21. Section 535FD strain response (with HVS and temperature control chamber).	54
Figure 4.22. Section 536FD JDMD results (no HVS, no temperature control chamber).....	59
Figure 4.23. Section 536FD JDMD results (with HVS, no temperature control chamber).....	59
Figure 4.24. Section 536FD JDMD results (with HVS and temperature control chamber).....	60
Figure 4.25. Section 536FD MDD results (no HVS, no temperature control chamber).	62
Figure 4.26. Section 536FD MDD results (with HVS, no temperature control chamber).	63
Figure 4.27. Section 536FD MDD results (with HVS and temperature control chamber).	63
Figure 4.28. Section 536FD strain response (no HVS, no temperature control chamber).	65
Figure 4.29. Section 536FD strain response (with HVS, no temperature control chamber).	66
Figure 4.30. Section 536FD strain response (with HVS and temperature control chamber).	67
Figure 4.31. Section 537FD JDMD results (no HVS, no temperature control chamber).....	73
Figure 4.32. Section 537FD JDMD results (with HVS, no temperature control chamber).....	73
Figure 4.33. Section 537FD JDMD results (with HVS and temperature control chamber).....	74
Figure 4.34. Section 537FD MDD results (no HVS, no temperature control chamber).	76
Figure 4.35. Section 537FD MDD results (with HVS, no temperature control chamber).	77

Figure 4.36. Section 537FD MDD results (with HVS and temperature control chamber).	77
Figure 4.37. Section 538FD JDMD data (no HVS, no temperature control chamber).....	81
Figure 4.38. Section 538FD JDMD data (with HVS, no temperature control chamber).	81
Figure 4.39. Section 539FD JDMD results (no HVS, no temperature control chamber).....	86
Figure 4.40. Section 539FD JDMD results (with HVS, no temperature control chamber).....	86
Figure 4.41. Section 539FD JDMD results (with HVS and temperature control chamber).....	87
Figure 4.42. Section 539FD MDD results (no HVS, no temperature control chamber).	89
Figure 4.43. Section 539FD MDD results (with HVS, no temperature control chamber).	89
Figure 4.44. Section 539FD MDD results (with HVS and temperature control chamber).	90
Figure 4.45. Section 540FD JDMD results (no HVS, no temperature control chamber).....	94
Figure 4.46. Section 540FD JDMD results (with HVS, no temperature control chamber).....	94
Figure 4.47. Section 540FD JDMD results (with HVS and temperature control chamber).....	95
Figure 4.48. Section 540FD MDD results (no HVS, no temperature control chamber).	97
Figure 4.49. Section 540FD MDD results (with HVS, no temperature control chamber).	97
Figure 4.50. Section 540FD MDD results (with HVS and temperature control chamber).	98
Figure 4.51. Section 541FD JDMD results (no HVS, no temperature control chamber).....	101
Figure 4.52. Section 541FD JDMD results (with HVS, no temperature control chamber).....	101
Figure 5.1. Section 534FD test history.	104
Figure 5.2. Test history for 535FD.	105
Figure 5.3. Test history for 536FD.	106
Figure 5.4. Test history for 537FD.	107
Figure 5.5. Test history for 538FD	108
Figure 5.6. Test history for 539FD (first test phase).....	109

Figure 5.7. Test history for 539FD (second and third test phases).....	110
Figure 5.8. Test history for 540FD	111
Figure 5.9. Test history for 541FD.	112
Figure 5.10. Section 534FD JDMD responses to surface temperature (Section 7: no dowels, asphalt shoulder).....	116
Figure 5.11. Section 535FD JDMD responses to surface temperature (Section 7: no dowels, asphalt shoulder).....	117
Figure 5.12. Section 536FD JDMD responses to surface temperature (Section 9: dowels, tied concrete shoulder).....	119
Figure 5.13. Section 537FD JDMD responses to surface temperature (Section 9: dowels, tied concrete shoulder).....	120
Figure 5.14. Section 538FD JDMD responses to surface temperature (Section 9: dowels, tied concrete shoulder).....	121
Figure 5.15. Section 539FD JDMD responses to surface temperature (Section 11: dowels, asphalt shoulder, wide lane).....	124
Figure 5.16: Section 540FD JDMD responses to surface temperature (Section 11: dowels, asphalt shoulder, wide lane).....	125
Figure 5.17. Section 541FD JDMD responses to surface temperature (Section 11: dowels, asphalt shoulder, 4.3-m wide lane).	126
Figure 5.18. Relative movements across the joints for Design Section 7.....	130
Figure 5.19. Relative movements across the joints for Design Section 9.....	131
Figure 5.20. Design Section 11 relative movements across joints.	132
Figure 5.21. Summary of vertical and horizontal movements for all sections.	138

1.0 INTRODUCTION

Two sets of concrete test sections, each set approximately 210 m long, were constructed using a concrete mix with a blend of fast setting hydraulic cement and portland cement on State Route 14 about 5 miles south of Palmdale, California.(1) The two sets of sections are referred to as the North Tangent and the South Tangent. These sets of test sections, consisting of various combinations of plain jointed and undoweled concrete, were constructed and tested with the Heavy Vehicle Simulator (HVS). Design thickness was 100, 150, and 200 mm on the South Tangent, and 200 mm on the North Tangent. The North Tangent also included plain jointed concrete slabs with tie bars, dowels, and extra-wide lanes. A previous report (1) contains details of the complete construction process, the instrumentation plan, and the material specifications of all the layers. This report addresses some of the significant findings of HVS testing on the northbound test section (the North Tangent) of State Route 14 on the 200-mm thick concrete test sections.

The HVS is equipped with a removable temperature control chamber that encloses the entire trafficked area plus some additional space around the test pad. Figure 1.1 shows the HVS with its temperature control chamber installed.

Earlier studies (2) have shown that despite the fact that temperature control inside the temperature control chamber was exercised on earlier HVS tests on the Palmdale test sections, good correlation between surface deflection and surface temperature inside the chamber could not be found. This finding raised the concern that the air and surface temperatures outside the temperature control chamber may influence the performance of the concrete sections inside the chamber.

Based on these findings, a test program was developed to investigate the effects of temperature on slab edge and corner curling both inside and outside the temperature control



Figure 1.1. HVS with temperature control chamber at the Palmdale test sections.

chamber. These tests were conducted on eight HVS test sections. These eight sections consisted of 200-mm plain jointed concrete slabs placed on a 100-mm cement treated base (CTB) on a 150-mm aggregate subbase on top of the compacted subgrade. Table 1.1 gives details of the eight test sections.

Table 1.1 Test Section Details, North Tangent

Design Section	Test	Design Features	Slab Width (m)
7	534FD, 535FD	Asphalt shoulder	3.7
9	536FD, 537FD, 538FD	Tied concrete shoulder, dowels	3.7
11	539FD, 540FD, 541FD	Asphalt shoulder, dowels	4.3

Details of the complete construction process, section layouts, instrumentation plans and the material specifications of all the layers can be found in the previous report (1).

2.0 TEST OBJECTIVES

The main objective of this series of tests was to investigate the influence of daily temperature variations on the curling of concrete slabs at the edges and corners, and the horizontal opening of joints between slabs in eight HVS tests sections, both with and without the influence of the temperature control chamber. To isolate the effect of temperature, none of the test sections was subjected to HVS loading during this investigation. All readings were taken while the HVS wheel was stationary and raised above the concrete slabs.

The second objective was to study the effectiveness of dowels and tie bars in restricting vertical movement and transverse joint opening under the influence of daily temperature fluctuations, and the effect of a 4.3-m versus 3.7-m slab width on the same movements. As with the first objective, the test sections were not subjected to HVS loading during this part of the study.

3.0 TEST PROGRAM

The objectives mentioned in Section 2.0 were achieved through eight tests labeled 534FD through 541FD (Table 1.1). All HVS tests in this report have an FD designator. The FD refers to the Field HVS (as opposed to the “RF” designator used for all test conducted with the HVS stationed at the Richmond Field Station).

Table 3.1 details the location and starting times of each test. Slab numbers are used as references to the various HVS tests. The construction report (*I*) contains all details relating to the physical outlay of all sections on both the South and the North Tangents.

Table 3.1 Location and Start Times of Each Test

Test Number	Test Section Number	Slab Numbers	Start Date	Type of Joint
534FD	7	34, 35, 36	11 March 2000	No dowels, asphalt shoulder
535FD	7	31, 32, 33	17 March 2000	
536FD	9	26, 27, 28	7 April 2000	Dowels and tied to concrete shoulder
537FD	9	22, 23, 24	14 July 2000	
538FD	9	18, 19, 20	29 December 2000	
539FD	11	10, 11, 12	26 August 2000	Dowels, asphalt shoulder, wide lane
540FD	11	6, 7, 8	4 October 2000	
541FD	11	2, 3, 4	30 November 2000	

The tests described in this report were performed over the several days preceding each of the fatigue loading tests described in the test plan for HVS testing (*I*). The test numbers in this report are the same those used for the fatigue study.

In order to investigate environmental influences on the edge and corner curl of the various slabs, three cases were investigated:

- **The HVS sits off the test pad and the whole test section is exposed to direct sunlight.** In this phase, the entire test area was exposed to direct sunlight, which led to the development of the maximum possible temperature differential for the given

day. Due to this, the stresses and strains developed inside the concrete slab as a result of temperature fluctuations were more severe than in the other two cases.

- **The HVS is parked over the test pad without the temperature control chamber.**

In this phase, the chamber was dismantled and the complete concrete slab was exposed to outside ambient temperatures while the HVS was positioned over the test pad. Consequently, owing to the shade of the HVS on the concrete surface, part of the area (approximately 22.5×3.7 m) was not exposed to direct sunlight during the greater part of the day. During this phase, a noticeable temperature differential developed due to the migration of heat from the exposed PCC surface areas to the shaded testing area, but not as severe as the case where the complete section was exposed to direct sunlight.

- **The HVS is parked on the test section with the temperature control chamber installed and in operation on the section.**

In this phase, an area of the concrete slabs (10.6 m long and 3.7 m wide) was covered with the temperature control chamber. The air inside the chamber was kept at a constant temperature of approximately 20°C . The temperature control chamber was used to attempt to keep the temperature differential (surface temperature – the temperature at the bottom of the PCC layer) as close as possible to zero inside the testing area to minimize the development of stresses and strains due to temperature effects. The intent was to evaluate fatigue performance under loading stresses only with no temperature induced stresses.

Readings were taken every two hours for 24 hours for each of the test cases.

3.1 Instrumentation and General Layout

The test sections were instrumented as described in reference (1). A brief summary is given in the following sections. The HVS test pad (8×1 m) spans 3 slabs, the greater part of the test section being over the middle slab. Figures 3.3 through to 3.10 show the placement of the HVS, the temperature control chamber, and all instrumentation with respect to the concrete slabs under evaluation for all eight HVS tests (534FD to 541FD).

3.1.1 Joint Deflection Measuring Device (JDMD)

Six Joint Deflection Measuring Devices (JDMD) were used per test section. Of the six JDMDs, five were aligned vertically. One (vertical) was placed at midpoint of the outside edge of the middle slab. Two more (vertical) were placed on either side of the middle slab at the corners. Another two JDMDs (vertical) were placed at the corners of the adjacent slabs bordering the middle slab. The sixth JDMD was aligned horizontally and placed between the transverse joint of the middle slab and an adjacent slab.

The purpose of horizontally aligned JDMD was to record the differential horizontal movement between two slabs as a result of daily temperature fluctuations. A graphical presentation of the JDMD layout is provided in Figure 3.1. JDMDs 1, 2, 4, and 5 were used to record corner movements; JDMD 3 recorded edge movements; and JDMD 6 was used to record the horizontal joint movement.

3.1.2 Multi-Depth Deflectometer (MDD)

MDDs were placed between the two wheel paths of the dual HVS loading wheels, approximately 300 mm from the edge of the concrete slab. All MDDs were fitted with 4 in-depth LVDTs, placed at depths of 100 mm, 300 mm, 450 mm, and 650 mm. However, for this

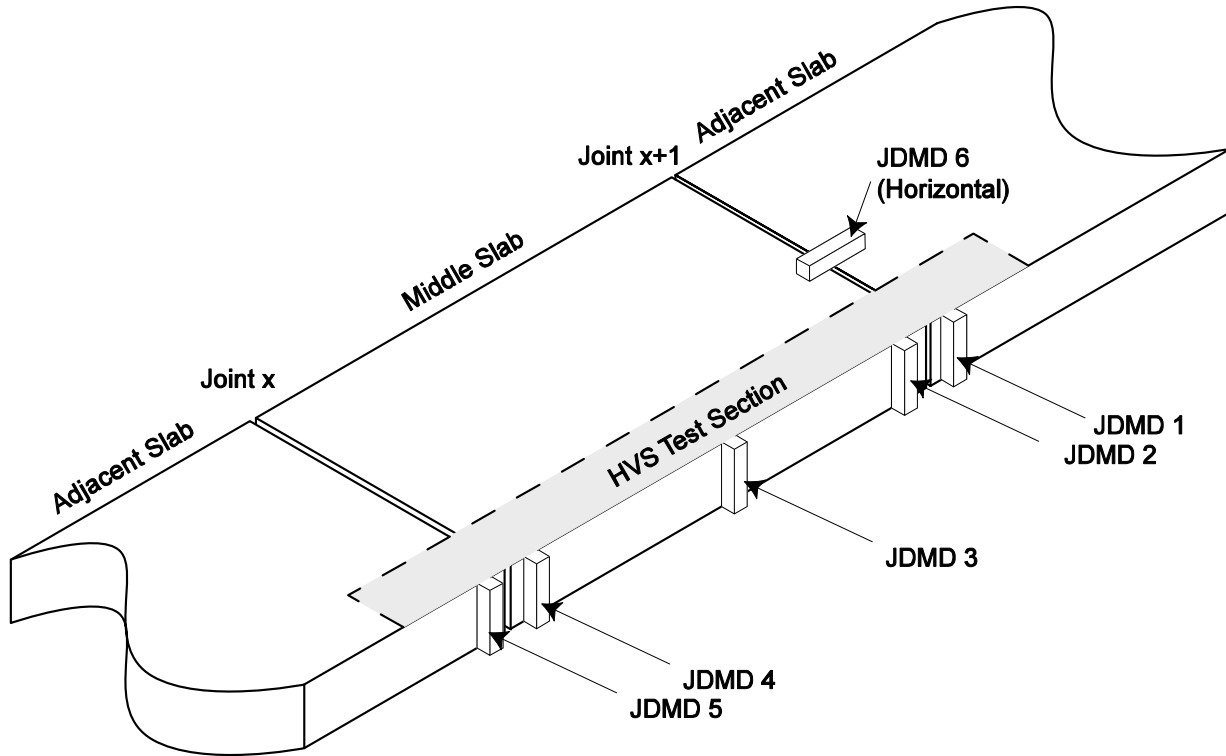

Figure 3.1. Placement of JDMD instruments with respect to the test sections.

study, only the results of the uppermost LVDT (placed at a depth of 100 mm in the PCC layer) were analyzed, as this study was limited to investigation of the movement of the concrete slab and does not include the behavior of the underlying layers.

Not all sections were instrumented with MDDs. MDD locations for sections that had them are given later in Table 3.2.

3.1.3 Strain Gauges

Two types of strain gauges, the Dynatest model PAST-2PCC and the Tokyo Sokki PMR-60-6L, were used. The Dynatest gauge is uni-axial and was placed longitudinally or perpendicular inside the concrete. The depth was approximately 40 mm from the bottom of the concrete layer (the interface between the concrete and the base layer).

The Tokyo Sokki gauge consists of a three-dimension rosette and was placed in such a way that one arm was perpendicular to the direction of HVS wheel loading (in order to record transverse strains), one was placed parallel to the direction of HVS loading (in order to record longitudinal strains) and the third was placed at a 45-degree angle between the other 2 arms.

In this report, the parallel arm is referred to as PMR X (parallel to the trafficking HVS wheel), the transverse arm as PMR Y, and the 45-degree arm as PMR M. The Tokyo Sokki gauges were all placed close to the surface of the 200-mm thick concrete sections at a depth of about 40 mm beneath the concrete surface.

An illustration of all the possible locations of the various strain gauges with respect to the PCC slab can be seen in Figure 3.2.

The strain gauges were placed inside the various test pads as described in Table 3.2. Additional strain gauges were placed in the slabs but were not in working order for sufficient time to include the results in this report. In this report, only the results from the functioning gauges are reported.

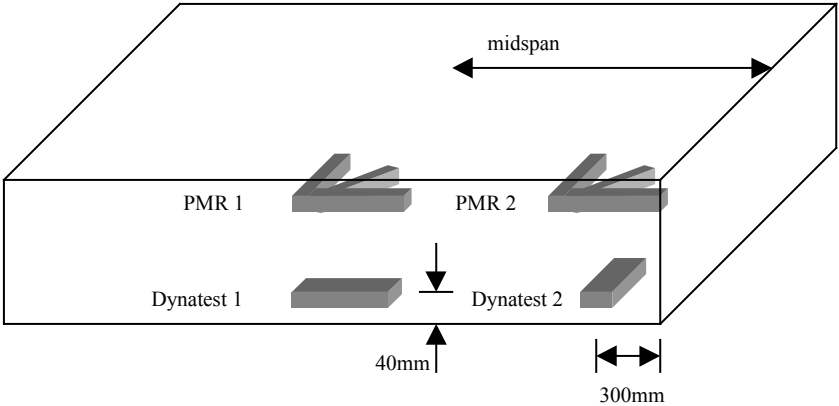

Figure 3.2. Placement of strain gauges.

3.1.4 Thermocouples

Thermocouples were placed in such a way as to capture temperatures in the 200-mm thick concrete slabs for all three environmental cases. Thermocouples were placed as follows at the surface, and at depths of 100 mm and 200 mm in the 200-mm thick concrete slab at the following positions:

- inside the temperature control chamber (TC test pad);
- under the HVS in the shade (TC shade);
- at a place where the thermocouple was completely exposed to direct sunlight 100 percent of the day (TC sun), and
- at a position between the HVS and the adjacent K-rail, where an area was partially exposed to the sun, owing to the shade caused by the HVS and the K-rail (TC K-rail).

This thermocouple configuration was repeated for all North Tangent test sections (534FD through to 541FD). The detailed layout of all sections, the placement of all instrumentation with relation to the various concrete slabs, the HVS and its temperature control chamber are presented in Figures 3.3 through to 3.10 for each of the eight sections.

3.2 Data Collection Schedule

To enable the stated objectives to be addressed, various 24-hour tests were executed. Data collection was performed on a two-hourly basis for each test and all instruments were monitored. The aim was to conduct testing only during clear, cloudless days, which would maximize the curling effect of the concrete as a result of high temperature differentials.

In order to isolate the effect of the temperature control chamber and the shade of the HVS on top of the concrete slabs, data were collected during three distinct phases of HVS testing (as detailed in Section 3.0):

- No HVS for 24 hours;
- With HVS but without temperature control chamber and without loading for 24 hours, and
- With HVS and the temperature control chamber but without any HVS loading for 24 hours.

3.3 Slab Geometry

Slab corner curl in concrete pavements is also a function of the slab dimensions. At Palmdale, various slab sizes were used. To assist in the interpretation of the data presented in Section 4, the details of all slabs tested are summarized in Table 3.2.

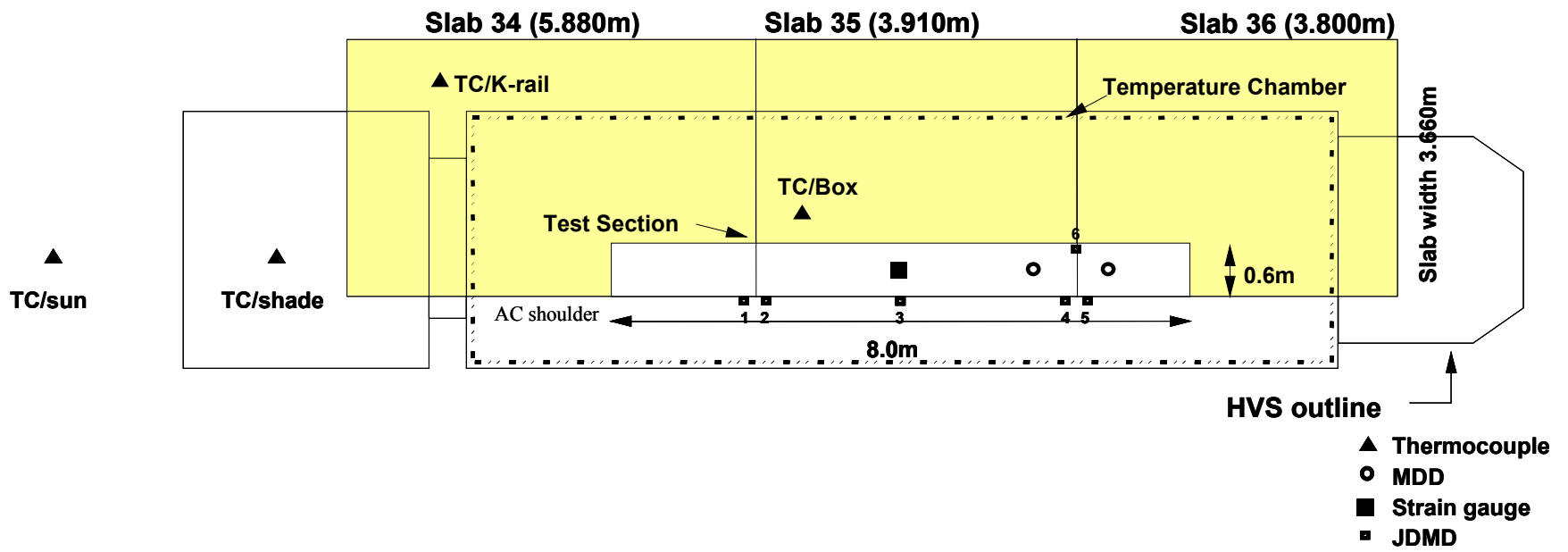

Figure 3.3. Instrumentation layout of Test Section 534FD.

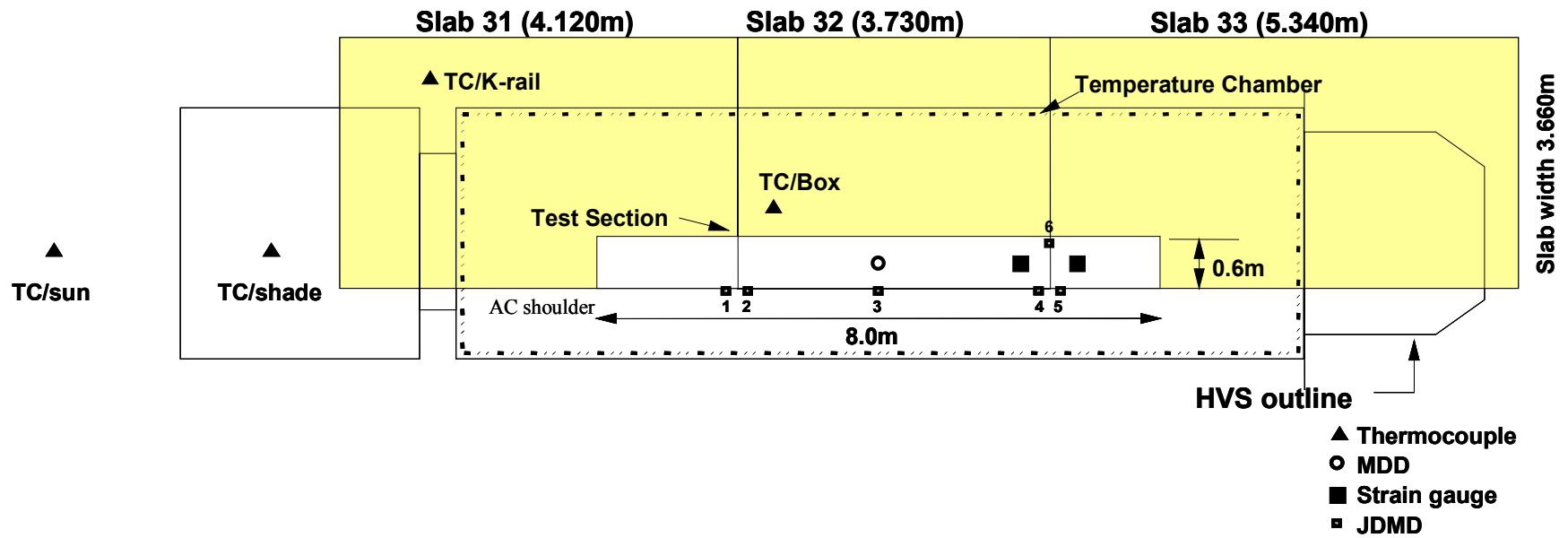

Figure 3.4. Instrumentation layout of Test Section 535FD.

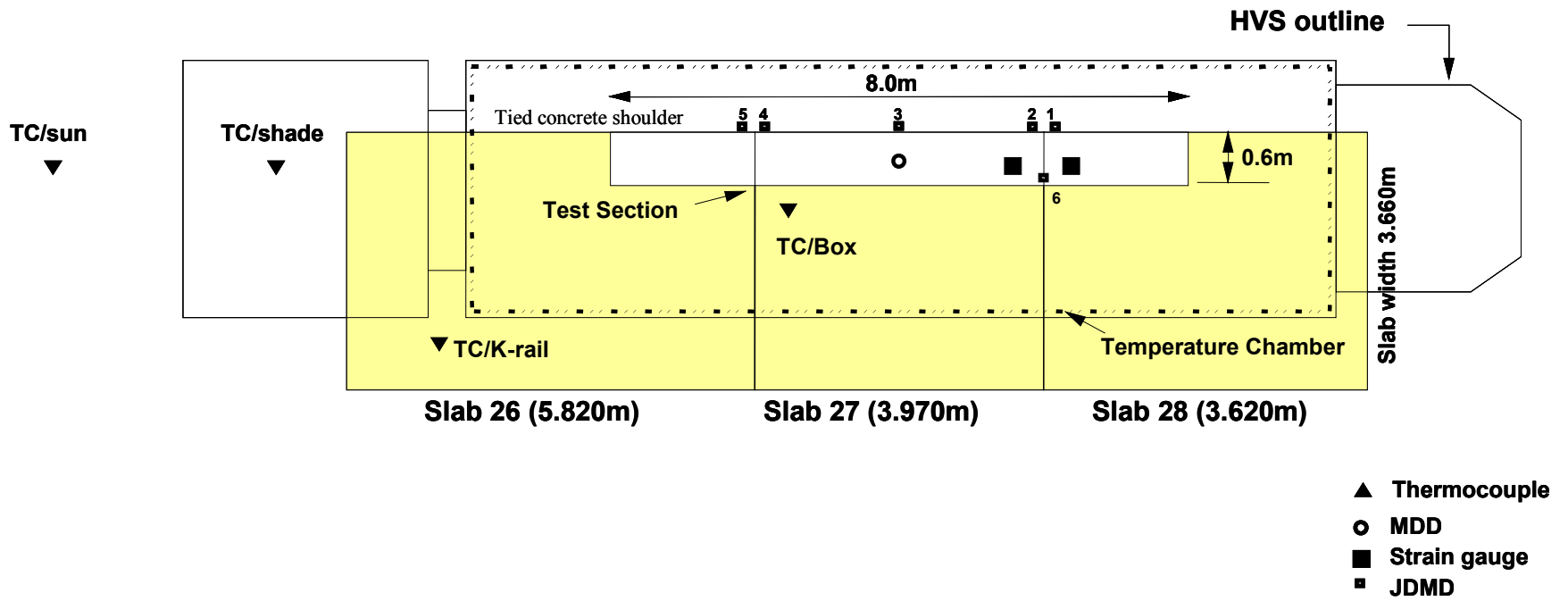

Figure 3.5. Instrumentation layout of Test Section 536FD.

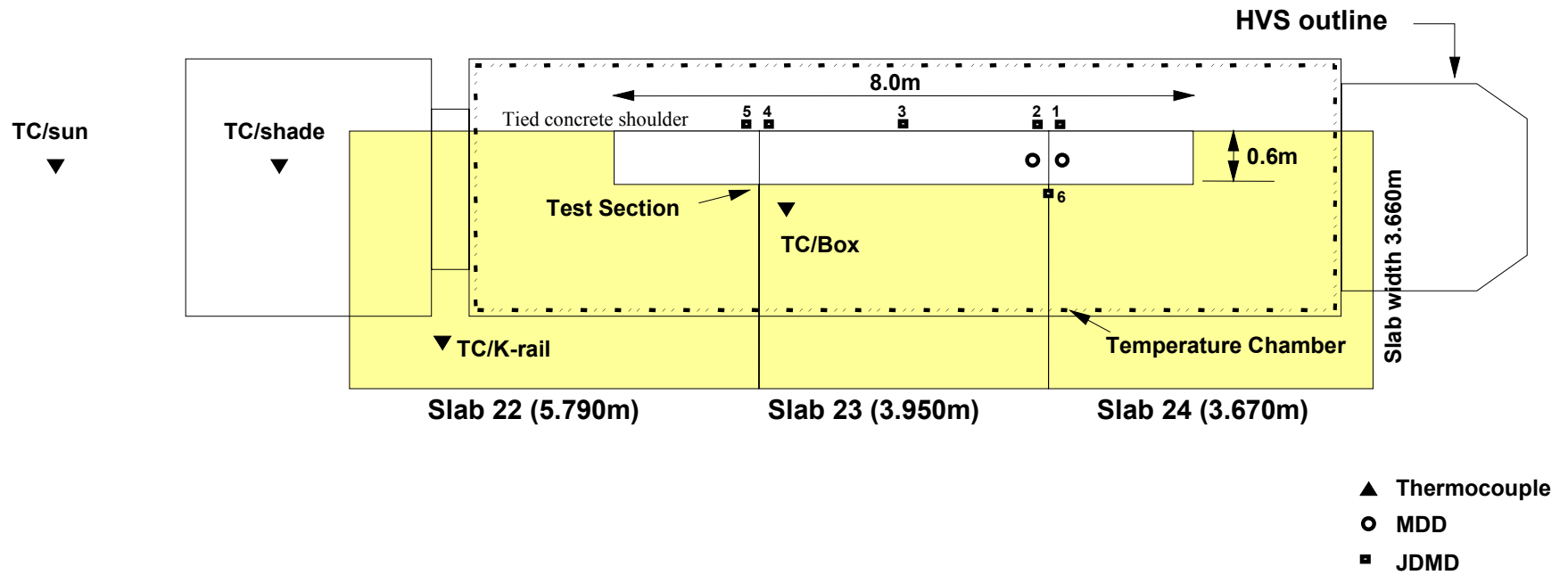

Figure 3.6. Instrumentation layout of Test Section 537FD.

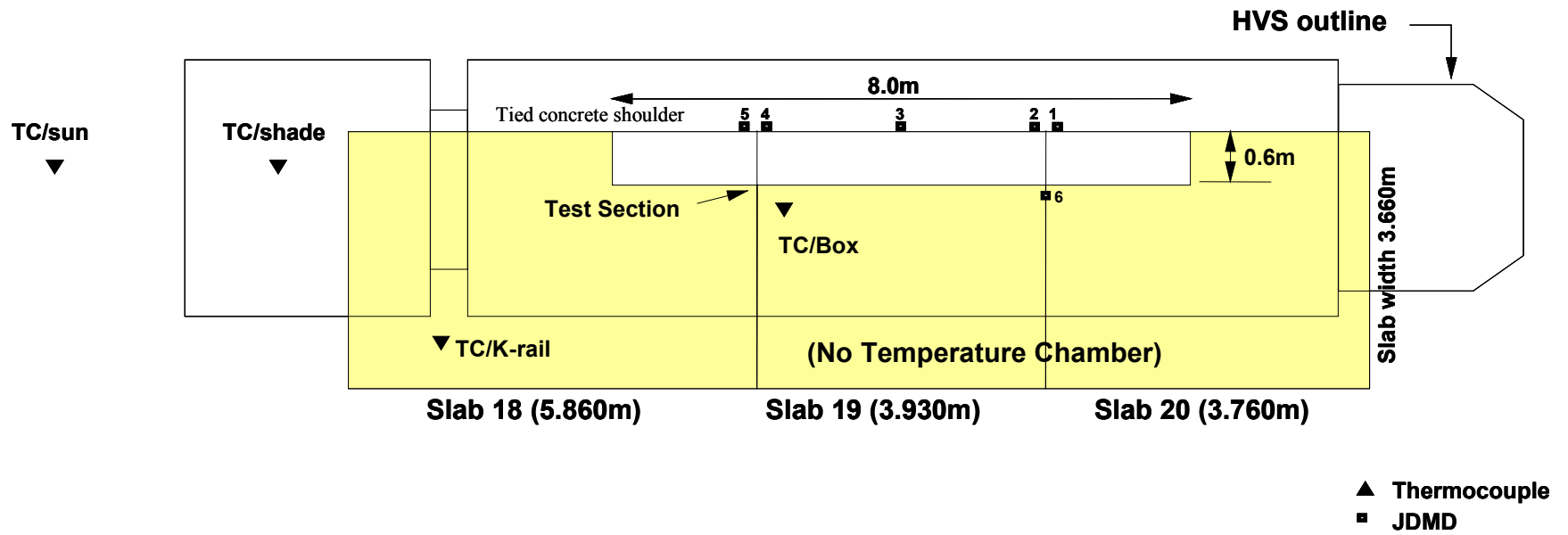

Figure 3.7. Instrumentation layout of Test Section 538FD.

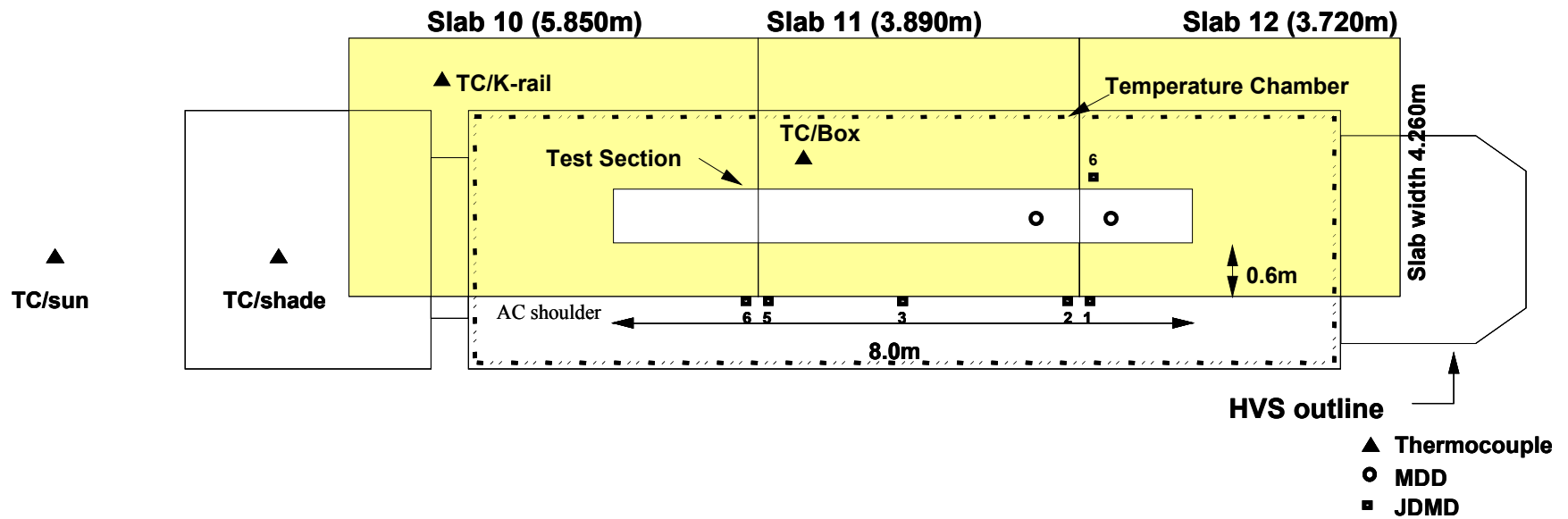

Figure 3.8. Instrumentation layout of Test Section 539FD.

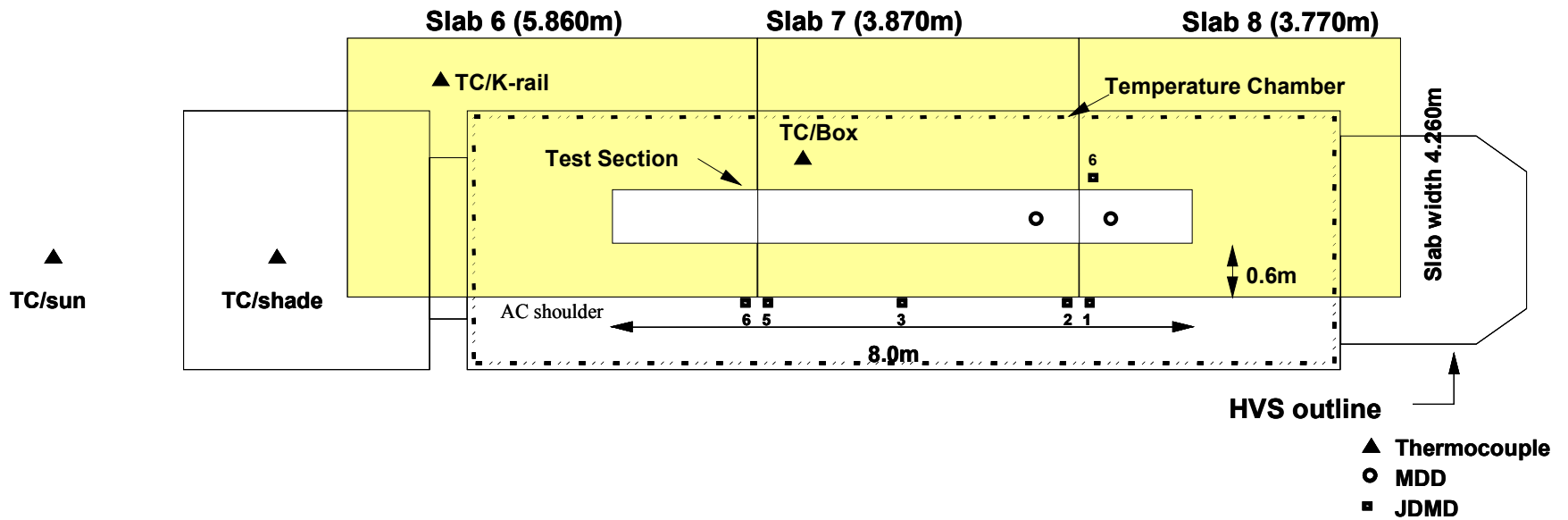

Figure 3.9. Instrumentation layout of Test Section 540FD.

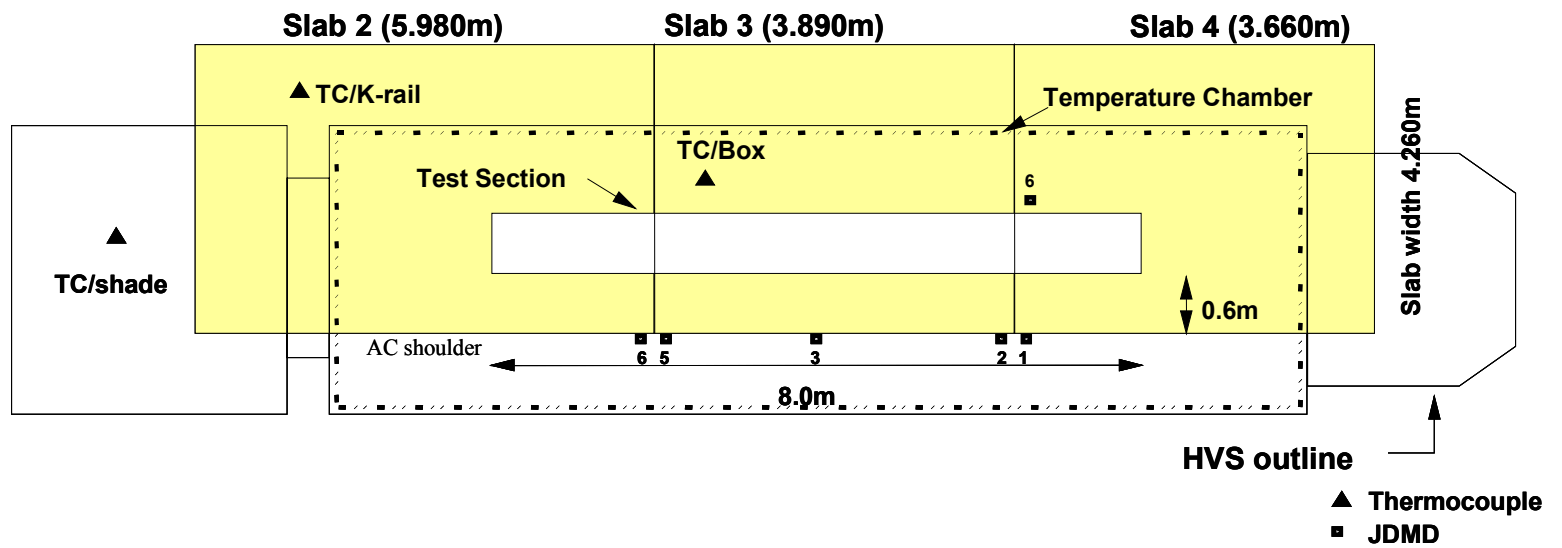

Figure 3.10. Instrumentation layout of Test Section 541FD.

Table 3.2 Test Slab Details and Instrumentation

Test Number	Design section	Slab numbers	Slab dimensions (m)		MDD & strain gauge configuration		
			Length	Width	MDDs	Dynatest gauges	Tokyo Sokki gauges
534FD	Section #7: no dowels, asphalt shoulder	34	5.88	3.66	2 MDDs, 300mm on either side of joint 35, one in slab 35 and the other in slab 36	Instrument #D10 in the middle of slab 35 (the middle slab) about 300 mm from the edge	Gauge #P9 in the middle of slab 35 (the middle slab) about 300 mm from the edge
		35	3.91	3.66			
		36	3.80	3.66			
535FD	Section #9: dowels and tied concrete shoulder	31	4.12	3.66	1 MDD in the middle of slab 32 between joints 31 and 32	#D8 in the middle slab (32) about 300 mm from the joint 32, between slabs 32 and 33 #D9 in slab 33, about 300 mm from joint 32	#P7 in the middle slab (32) about 300 mm from the joint 32, between slabs 32 and 33 #P8 placed in slab 33, about 300 mm from joint 32
		32	3.73	3.66			
		33	5.34	3.66			
536FD	Section #11: dowels, asphalt shoulder, wide lane	26	5.82	3.66	1 MDD in the middle of slab 27 between joint 26 and 27	#D16 close to joint 27 in slab 27 #D17 close to joint 27 in slab 28	#P15 close to joint 27 in slab 27 #P16 close to joint 27 in slab 28
		27	3.97	3.66			
		28	3.62	3.66			
537FD	Section #7: no dowels, asphalt shoulder	22	5.79	3.66	2 MDDs, 300mm from either side of joint 23, one in slab 23 and the other in slab 24	#D19 close to joint 22 in slab 22 #D20 close to joint 22 in slab 23 #D21 in the middle of slab 23, between joint 22 and 23	#P19 close to joint 22 in slab 22 #P20 close to joint 22 in slab 23 #P22 in the middle of slab 23, between joint 22 and 23
		23	3.95	3.66			
		24	3.67	3.66			
538FD	Section #9: dowels and tied concrete shoulder	18	5.86	3.66			
		19	3.93	3.66			
		20	3.76	3.66			
539FD	Section #11: dowels, asphalt shoulder, wide lane	10	5.85	4.26	2 MDDs, 300mm from either side of joint 11, one in slab 11 and the other in slab 12	#D25 close to joint 10 in slab 10 #D26 close to the edge of joint 10 in slab 11 #D27 in the middle of slab 11, between joints 10 and 11	#P27 close to joint 10 in slab 10 #P28 close to the edge of joint 10 in slab 11 #P30 in the middle of slab 11, between joints 10 and 11
		11	3.89	4.26			
		12	3.72	4.26			
540FD	Section #7: no dowels, asphalt shoulder	6	5.87	4.26	2 MDDs, 300mm from either side of joint 7, one in slab 7 and the other in slab 8	#D24 close to joint 6 in slab 7	#P26 close to joint 6 in slab 7
		7	3.87	4.26			
		8	3.77	4.26			
541FD	Section #9: dowels and tied concrete shoulder	2	5.98	4.26		#D22 close to joint 3 in slab 3 #D23 close to the edge of joint 3 in slab 4	#P23 close to joint 3 in slab 3 #P24 close to the edge of joint 3 in slab 4
		3	3.89	4.26			
		4	3.66	4.26			

4.0 RESULTS

The results of the various instrument measurements from the three test sections are summarized in this section.

4.1 Concrete Curling Modes

Slab corner curling is caused by temperature differentials between the top and the bottom of the slab. Concrete contracts as the temperature decreases and expands as the temperature rises. If the top and bottom of the concrete slab are not at the same temperature, the resulting temperature differential causes the slab to curl, with the corners moving either upward or downward.

During the day, the upper surface area (exposed to direct sunlight) heats up and causes the upper surface to expand. The bottom surface (200 mm below the top surface) does not reach the same temperature, as it is not exposed to sunlight. The net effect of this is that the slab corners tend to curl downward, because the bottom of the slab expands less than the top.

During the night, the effect is reversed. The upper surface, exposed to the open air, cools more rapidly than the underside. This causes the top part of the slab to contract more than the bottom part (which is not exposed to the ambient air temperature) and the slab corners to curl upward. This effect is illustrated in Figures 4.1 for edge and corner curling.

Curling caused by temperature difference between the top and bottom of the slab and total slab expansion is visible at the transverse construction joints. During the night, the concrete contracts and corners curl upward, which causes the gap in the joint at the surface to widen. During the day, the opposite occurs: the slab heats up, expands and the corners curl downward, closing the gap between the slabs at the surface. The effect of this was measured by JDMD 6, which was placed horizontally across the joints, as is illustrated in Figure 4.2. To assist in the

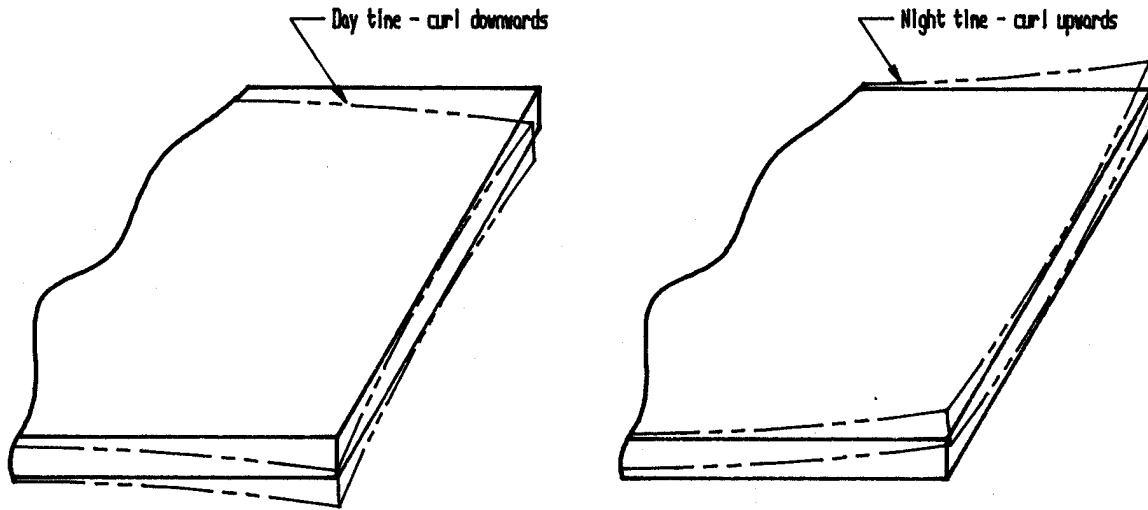
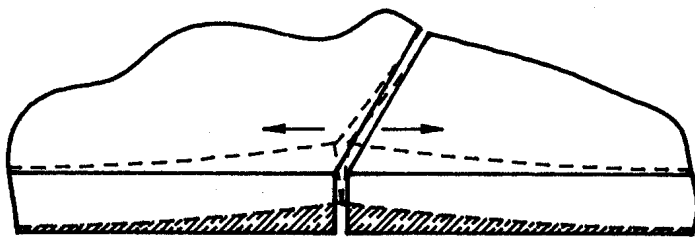
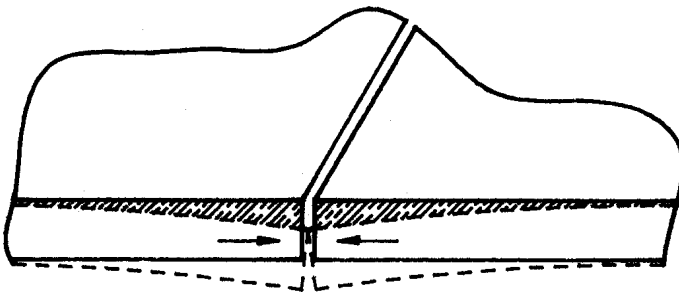

Figure 4.1. Edge and corner curling caused by daily temperature variation.



Night time: Slab shrinks and curls upwards - joint gap increases.



Day time: Slab expands and curls downwards - joint gap decreases.

Figure 4.2. Horizontal movement at transverse joints caused by daily temperature variation.

interpretation of the results produced by the horizontal JDMD 6, the tables include the total day-to-night temperature changes measured during a 24-hour time window.

The maximum curling along the edge and the transverse joints is obviously influenced by the total area exposed to direct sunlight. For this reason, the study was broken down into the three stages mentioned in Section 3.2.

It was anticipated that the shading (due to the HVS) and the temperature control chamber would limit temperature changes in the instrumented slabs. This would eliminate large temperature differentials between the top and the bottom of the concrete slab, in contrast to the case in which the whole section was exposed to direct sunlight. In this document, all relevant temperature differentials and day/night temperature changes are reported (surface and air temperatures, inside and outside the temperature control chamber).

4.2 Assumptions Regarding Warping Caused by Differential Shrinkage

Because all elastic deformation measurements are relative to a pre-determined reference point, the following methodology was followed for this study.

It was assumed that the concrete slab is in a planar (flat) position when there is a zero temperature differential between the top and the bottom surfaces of the slab. This assumption ignores the effects of differential shrinkage, which cause warping. During a 24-hour cycle, a concrete slab typically experiences two times when the temperature differential is zero, once in the morning and once during late afternoon. In this study, sensor displacement at the time during which the temperature differential (top – bottom) was zero, has been used as the reference point for all the measurements.

It is important to note that the shape of the concrete slab after setting is not planar. Because of differences in shrinkage between the top and bottom of the slab, it is quite possible

that the shape of the slab at zero temperature differential will not be planar and the slab may actually be permanently warped with no temperature differential. It has been found in earlier reports (2) that the Palmdale sections did not have planar horizontal slabs, and that lift-off between the slab and the base was observed all along the slab edge. These observations indicate that the corners and edges of the concrete slabs at Palmdale have warped upward.

The effect of this is that a negative temperature differential (during the night) will cause the slab edges and corners to curl upward even more and that a positive temperature differential (during the day) will cause the slab corners and edges to curl downward, but they may never go down past a planar shape.

Another way of presenting the data is to ignore the whole discussion of the true position of the slabs when they are in a state of zero temperature differential, and to simply report the total elastic movement during a 24-hour cycle in relation to the total maximum temperature differences between the top and the bottom of the slabs during the same time period.

The results in this report reflect both of these approaches.

As far as strain measurements are concerned, the interpretation of results is even more complex. Because the true strain state (after placement and setting) of the concrete slabs is not known, it is difficult to relate the data collected to a single reference value. In this report, the methodology followed was the same as that used with the MDDs and JDMDs. The strain value at which the temperature differential was zero was taken as the reference. Thus, all strain results reported in this report reflect the strain change from this reference value. The total strain variation in a 24-hour cycle is also reported against the total maximum temperature differences recorded during the same 24-hour cycle.

The measured coefficient of thermal expansion for the concrete used at the sections in Palmdale is $8.2 \mu\epsilon/^\circ\text{C}$. (2)

4.3 Explanation of Terms For Temperature and Slab Thermal Effects

To assist in the interpretation of the tables and graphs in this report, definitions of certain temperature terms are explained in the following sections.

4.3.1 Temperature Differential and Curl Measurement

Temperature differential is used to define the difference in temperature between the top surface and the bottom of the concrete layer. Typically, during the day, this value is positive and during the night, this differential is negative. Downward curl at the edges and corners is associated with a positive temperature differential and vice versa.

The total movement (the absolute sum of the downward and upward curl) is presented together with the total temperature difference, where the total temperature difference is the total variation of the temperature differentials in a 24-hour observation window.

For instance, if the maximum upward curl at 14:00 is + 1.5 mm when the temperature difference is $+7.5^\circ\text{C}$ and the maximum downward curl is -0.75 mm when the temperature difference is -4.3°C , then the total movement in the 24-hour observation window is 2.25 mm ($1.5 - (-0.75)$), caused by a total temperature difference of $+7.5^\circ\text{C} - (-4.3^\circ\text{C})$ or 11.8°C .

4.3.2 Temperature Change and Joint Opening/Closing Measurement

The horizontal movement of the concrete slabs (expansion and contraction) recorded at the joints by JDMD 6 is mainly due to the change in the ambient temperature during the 24-hour observation window. The total horizontal movement reported is the absolute sum of the

maximum opening and closing movements of the joint in 24 hours under the influence of the change in day/ night ambient temperatures.

For instance, if the maximum opening of the joint at 02:30 is -0.3 mm and the maximum closing movement at 13:00 is $+0.85$ mm, then the total movement is 1.15 mm. During that day, the maximum outside air temperature was 33°C and the minimum was 12.5°C , when means that the maximum total day-to-night air temperature change was 20.5°C ($33 - 12.5$). In the tables, the maximum total 24-hour day-to-night air as well as concrete surface temperature changes are reported.

4.3.3 Sign Convention

The sign convention of the JDMD data presented is as follows:

- Negatively increasing values indicate a downward movement of the slab edge.
- Positively increasing values indicate an upward movement of the slab edge.

JDMD 6, being horizontal, has a different sign convention: positively increasing values indicate that the joint gap is closing and decreasing values represent an opening of the gap at the transverse joints.

4.4 Test 534FD

The results of the various instruments placed at Test Section 534FD are presented in the following sections.

4.4.1 JDMD data

The responses of all six JDMDs are shown in Figures 4.3 to 4.6. The figures display the data using zero deflection at the time when there was no temperature difference between the top and bottom of the slab ($dT = 0$). This occurred at about 9:00 in the morning. The figures present the JDMD movement as well as the corresponding temperature difference (top surface – bottom) of the various thermocouples on the right hand scale of the graphs.

The figures display the results of all three cases:

- HVS off site (Figure 4.3),
- HVS on site but without the temperature control chamber in place (Figure 4.4), and
- HVS on site with the fully functional temperature control chamber erected (Figure 4.5).

From Figure 4.3, it is clear that the temperature difference between the top and bottom of the slab with no HVS and no temperature control had a significant influence on the corner and edge curling movement. A total maximum movement of 2.8 mm was recorded with a maximum temperature difference of 16.7°C . This was measured at JDMD 2, which was at the right hand corner of the middle slab (refer to Figure 3.3). The results are summarized in Table 4.1.

It is important to note that the maximum temperature differentials as presented in Table 4.1 (and all subsequent tables containing temperature results) are the temperature differences (top – bottom) at the time during which the maximum slab movement took place and not the absolute maximum temperature difference that occurred during the 24 hour measuring window.

The results presented in Table 4.1 and Figure 4.3 make logical sense: during the day, the slab is hotter at the surface than at the bottom. This causes the slab to expand and the corners to

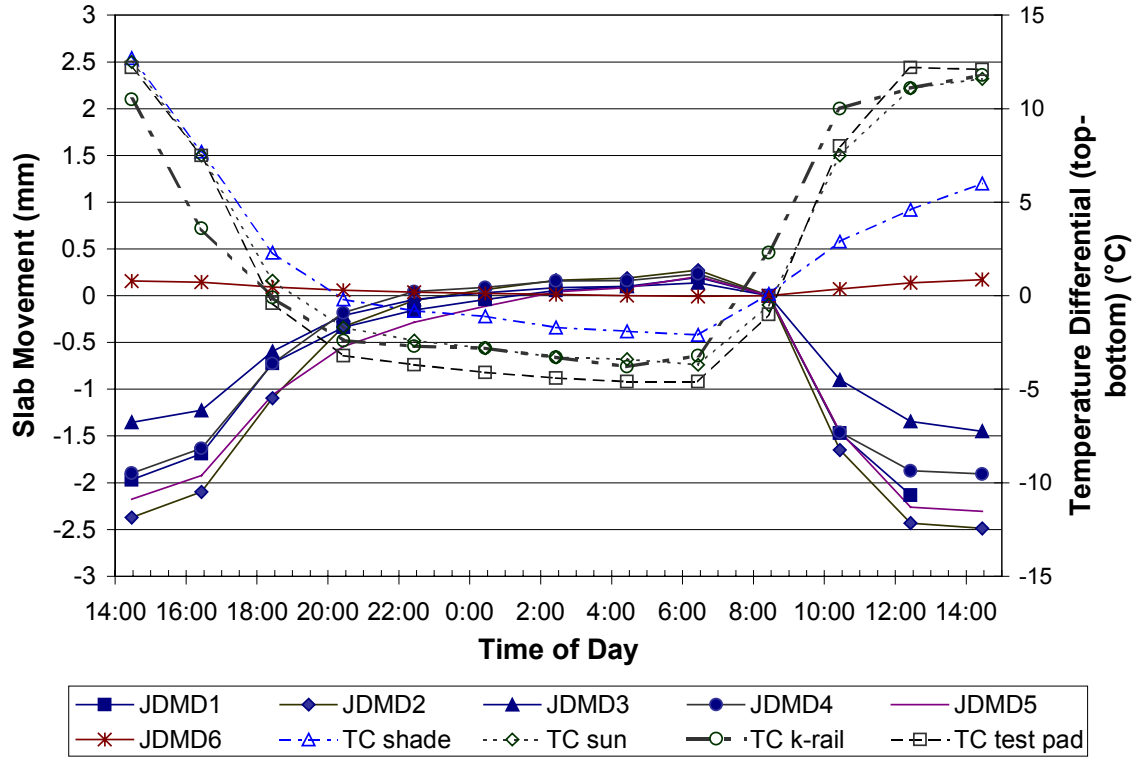

Figure 4.3. Section 534FD JDMD results (no HVS, no temperature control chamber).

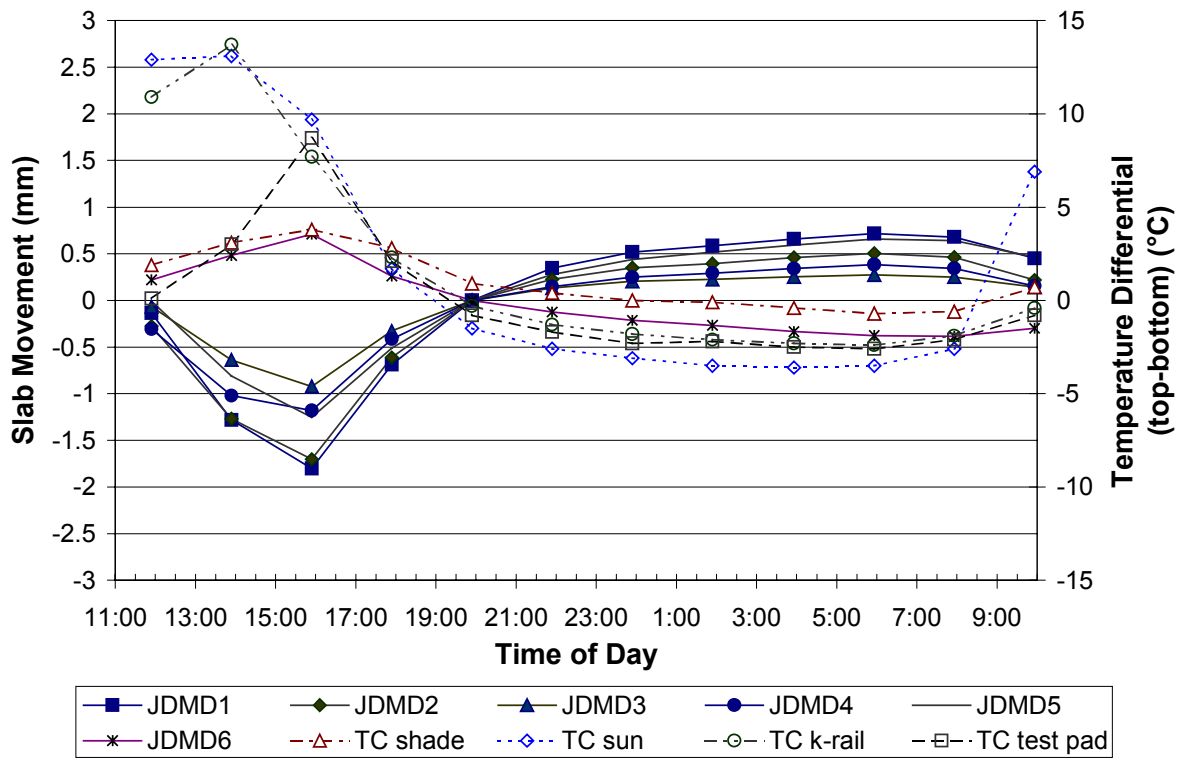

Figure 4.4. Section 534FD JDMD results (with HVS, no temperature control chamber).

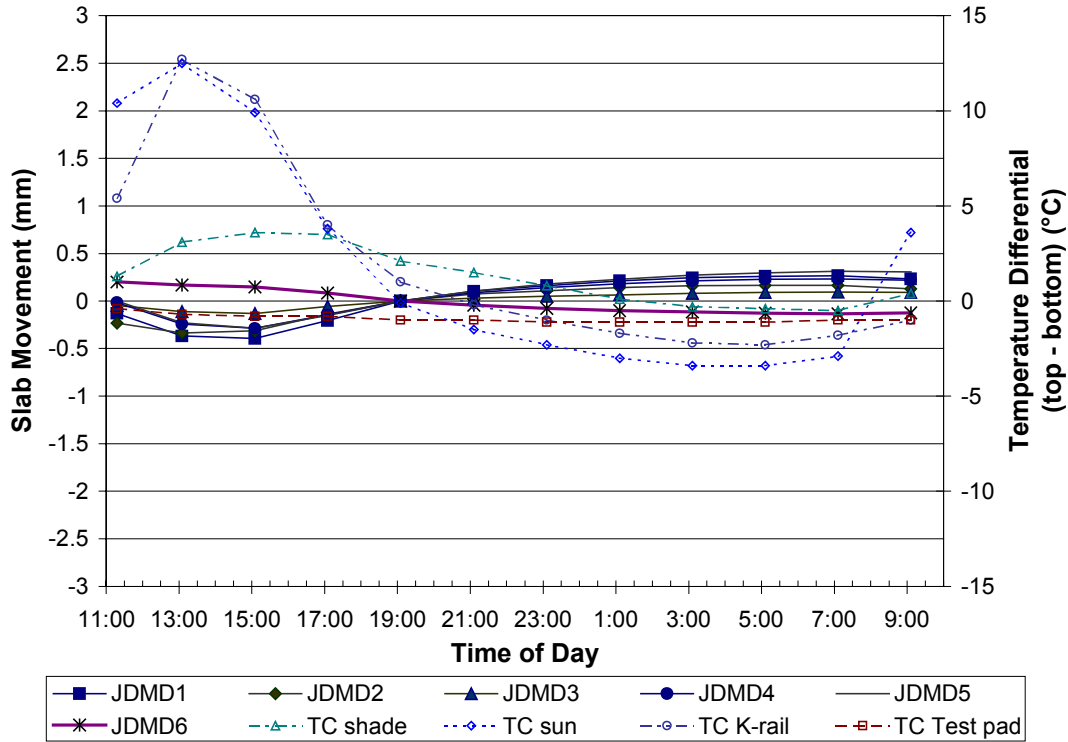

Figure 4.5. Section 534FD JDMD results (with HVS and temperature control chamber).

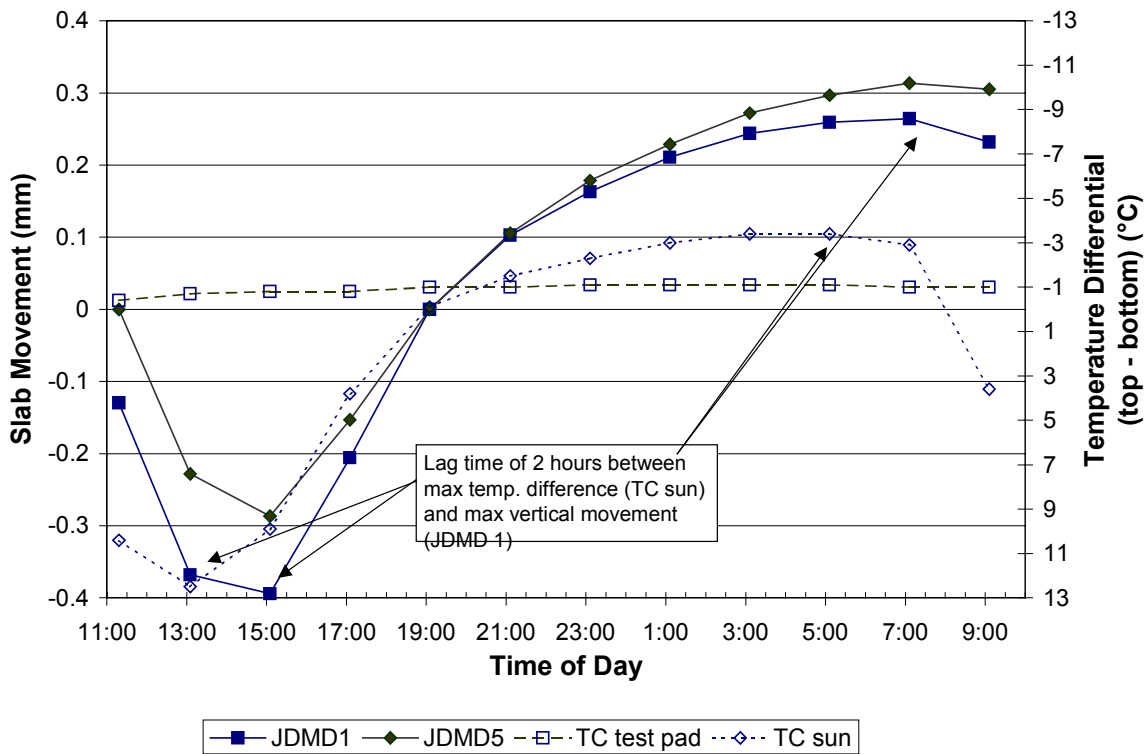

Figure 4.6. Section 534FD lag time when temperature control chamber is used.

Table 4.1 Summary of JDMD Results at Section 534FD (no HVS, no Temperature Control Chamber)

		Critical Case	all JDMD data				
			1	2	3	4	5
JDMD 1 to 5: Vertical edge and corner movements							
Max downward Movement							
time of day	2:27 PM						
Outside air temp (°C)	27.1						
Surface temp (°C)	35.3						
Temp difference at time of max movement (°C)	12.1						
Max downward Movement (mm)	-2.489	-2.133	-2.489	-1.450	-1.907	-2.307	
position	JDMD-2						

Max upward Movement						
time of day	6:26 AM					
Outside air temp (°C)	14.9					
Surface temp (°C)	14.7					
Temp difference (°C)	-4.6					
Max upward Movement (mm)	0.272	0.196	0.272	0.139	0.235	0.205
position	JDMD-2					
Maximum total movement (mm)	2.761	2.329	2.761	1.589	2.141	2.512
Total temp difference (top - bottom) (°C)	16.7					

Horizontal slab edge movement JDMD 6	
time of day	2:27 PM
Outside air temp (°C)	27.1
Surface temp (°C)	35.3
Temp difference (°C)	12.1
Max Closing Movement (mm)	0.857
time of day	6:26 AM
Outside air temp (°C)	14.9
Surface temp (°C)	14.7
Temp difference (°C)	-4.6
Max opening Movement (mm)	-0.045
Max total joint horizontal movement (mm)	0.902
Total temp difference (top-bottom) (°C)	16.7

Max total 24h day to night temperature changes	
Air temp change: outside temp box (°C)	14.7
Air temp change: inside temp box (°C)	14.7
Surface temp change: outside temp box (°C)	20.6
Surface temp change: inside temp box (°C)	20.6

curl downward. The transverse joint follows the same pattern as suggested in Figure 4.2: the joint at the surface closes during the day under the influence of the increased ambient temperature.

During the night, the bottom of the slab is hotter than the top surface because the top cools more rapidly than the bottom. This causes the slab edge to curl upward and the transverse joint gap at the bottom of the slab to widen. It can be seen that the temperature differential indicates that the slab surface was nearly always positive.

The JDMD movements for the HVS without the temperature control chamber and with it are summarized in Tables 4.2 and 4.3, respectively.

The tables and the graphs clearly show that the temperature differential has a significant influence on the vertical edge movement. A comparison between the various cases is made in Table 4.4.

Regarding the horizontal slab movement (as measured by JDMD 6): total maximum movement of 0.902 mm was recorded under the influence of a total day-to-night surface temperature change of 20.6°C.

The effects of shade from the HVS and temperature control chamber are clearly visible. Because the concrete surface is more protected from outside temperature variations, the severity of vertical edge and corner curling drops. The maximum total vertical movement is reduced from 2.8 mm in the open (without the HVS being parked on the test pad) to 0.71 mm with the temperature control chamber in place and in operation.

Another important observation is that the temperature control chamber does not completely protect the test pad from outside influences, as is illustrated in Figure 4.6. Although the temperature differential (top – bottom) inside the temperature control chamber was close to

Table 4.2 Section 534FD Summary of JDMD Results (with HVS, without Temperature Control Chamber)

		Critical Case	all JDMD data				
			1	2	3	4	5
JDMD 1 to 5: Vertical edge and corner movements							
Max downward Movement							
time of day	3:54 PM						
Outside open air temp (°C)	25.1						
Air temp: under the HVS (°C)	26.2						
Surface temp away fom HVS (°C)	31.9						
Surface temp under HVS (°C)	30.9						
Temp difference (°C) away from HVS	9.7						
Temp difference (°C) under HVS	8.7						
Max downward Movement (mm)	-1.801	-1.801	-1.702	-0.922	-1.182	-1.252	
position	JDMD 1						
Max upward movement							
time of day	5:56 AM						
Outside air temp in open air	14.2						
Air temp: under the HVS	15.1						
Surface temp away fom HVS	13.8						
Surface temp under HVS	17.2						
Temp difference (°C) away from HVS	-3.5						
Temp difference (°C) under HVS	-2.6						
Max upward Movement (mm)	0.716	0.716	0.505	0.275	0.383	0.658	
position	JDMD 1						
Max total movement (mm)	2.517	2.517	2.208	1.197	1.565	1.909	
Total temp difference (top - bottom) under HVS (°C)	11.3						
Horizontal slab edge movement							
time of day	3:54 PM						
Outside air temp in open air (°C)	25.1						
Air temp: under the HVS (°C)	26.2						
Surface temp away fom HVS (°C)	31.9						
Surface temp under HVS (°C)	30.9						
Temp difference (°C) away from HVS	9.7						
Temp difference (°C) under HVS	8.7						
Max Closing Movement (mm)	0.710						
time of day	7:56 AM						
Outside air temp in open air (°C)	16.1						
Air temp: under the HVS (°C)	16.0						
Surface temp away fom HVS (°C)	14.2						
Surface temp under HVS (°C)	17.1						
Temp difference (°C) away from HVS	-2.6						
Temp difference (°C) under HVS	-2.1						
Max opening Movement (mm)	-0.386						
Max total joint horizontal movement (mm)	1.096						
Total temp difference (top - bottom) under HVS (°C)	10.8						
Max total 24h day to night temperature changes							
Air temp change: outside temp box (°C)	11.1						
Air temp change: inside temp box (°C)	11.2						
Surface temp change: outside temp box (°C)	19.3						
Surface temp change: inside temp box (°C)	13.8						

Table 4.3 Section 534FD Summary of JDMD Results (with HVS and Temperature Control Chamber)

		Critical Case	all JDMD data				
			1	2	3	4	5
JDMD 1 to 5: Vertical edge and corner movements							
Max downward Movement							
time of day	3:05 PM						
Outside open air temp (°C)	22.8						
Air temp: under the HVS (°C)	21.0						
Surface temp away fom HVS (°C)	29.9						
Surface temp under HVS (°C)	22.1						
Temp difference (°C) away from HVS	9.9						
Temp difference (°C) under HVS	-0.8						
Max downward Movement (mm)	-0.394	-0.394	-0.314	-0.132	-0.288	-0.287	
position	JDMD-1						
Max upward movement							
time of day	7:06 AM						
Outside air temp in open air	14.8						
Air temp: under the HVS	17.6						
Surface temp away fom HVS	13.2						
Surface temp under HVS	18.7						
Temp difference (°C) away from HVS	-2.9						
Temp difference (°C) under HVS	-1.0						
Max upward Movement (mm)	0.313	0.264	0.165	0.095	0.232	0.313	
position	JDMD-5						
Max total movement (mm)	0.708	0.659	0.479	0.227	0.520	0.600	
Total temp difference (top - bottom) under HVS (°C)	0.2						
Horizontal slab edge movement							
time of day	1:05 PM						
Outside air temp in open air (°C)	22.8						
Air temp: under the HVS (°C)	20.5						
Surface temp away fom HVS (°C)	29.9						
Surface temp under HVS (°C)	21.6						
Temp difference (°C) away from HVS	12.5						
Temp difference (°C) under HVS	-0.7						
Max Closing Movement (mm)	0.169						
time of day	7:06 AM						
Outside air temp in open air (°C)	14.8						
Air temp: under the HVS (°C)	17.6						
Surface temp away fom HVS (°C)	13.2						
Surface temp under HVS (°C)	18.7						
Temp difference (°C) away from HVS	-2.9						
Temp difference (°C) under HVS	-1.0						
Max opening Movement (mm)	-0.135						
Max total joint horizontal movement (mm)	0.303						
Total temp difference (top - bottom) under HVS (°C)	0.3						
Max total 24h day to night temperature changes							
Air temp change: outside temp box (°C)	8.4						
Air temp change: inside temp box (°C)	3.4						
Surface temp change: outside temp box (°C)	16.8						
Surface temp change: inside temp box (°C)	3.5						

Table 4.4 Section 534FD Summary of all JDMD Results

	No HVS	With HVS	With HVS and temperature chamber
Total max movement (mm)			
Vertical edge & corner movement	2.761	2.517	0.708
Horizontal transverse joint movement	0.902	1.096	0.303
Maximum temperature differences) (°C)			
On the test section (top - bottom)	16.7	11.3	0.2
In the sun (top - bottom)	16.7	13.2	12.8
Day to night air temperature change in the temperature chamber	14.7	11.2	3.4
Day to night surface temperature change in the temperature chamber	20.6	13.8	3.5

zero (0.2°C), the movements recorded by the JDMDs corresponded well with the temperature difference of the thermocouple placed in the sun. Although the total vertical movement was small (0.71 mm), this is still significant.

The horizontal joint movement is mainly influenced by the contraction and expansion of the slab along its length. The maximum horizontal movement recorded was 0.9 mm under the influence of a day-to-night air temperature change of 14.7°C. Maximum horizontal movement was reduced to 0.3 mm under the influence of a 3.4°C day-to-night temperature change inside the temperature control chamber.

It is also interesting to note that there was a lag between the time when the maximum temperature difference occurred and the time when the JDMDs recorded the greatest movement. The maximum temperature difference was recorded at about 13:05 in the afternoon, but the maximum vertical movement was recorded two hours later.

4.4.2 MDD data

Two MDDs were placed on the section near the corners (see Section 3.1.2). As no load was exerted on the concrete pavement, only the top module (situated at a depth of 100 mm inside

the slab) recorded any movement. The other modules in the base course and below did not record any movement resulting from temperature fluctuations. This indicates that the slabs changed shape independently of the support layers, including the CTB.

The results can be seen in Figures 4.7 to 4.9 and are summarized in Table 4.5 for all three cases mentioned.

The MDD results compare favorably with the JDMD data and display the same trend. The total movements of the MDDs are, however, lower than those recorded by the JDMDs. This can be explained by the positions of the various instruments. The JDMDs were placed at the free edge of the slab where the movement is at a maximum. The MDDs were placed about 300 mm from the edge where the slab movements can be expected to be lower.

There is one anomaly in the results: when the HVS is parked on the test pad, the temperature differential is smaller than when the HVS was not in position on the test section (as could be expected because the section was in the shade of the machine) but the vertical movements recorded by MDD 12 (1.84 mm in the shade) were higher than those recorded in the open (1.63 mm). The reason for this is unknown. A similar result was recorded for the JDMDs.

4.4.3 Strain Data

Of the four strain gauges placed in Slab 35 (see Section 3.1.3), two were in working order, one did not produce any readings, and one (the Dynatest gauge) produced readings but the daily variation was very small, giving rise to the suspicion that the gauge was not functioning properly. The gauges that did record correct readings were the PMR Y gauge (which was perpendicular to the direction of traffic) and the PMR M gauge (which was at a 45-degree angle between the longitudinal and transverse gauges).

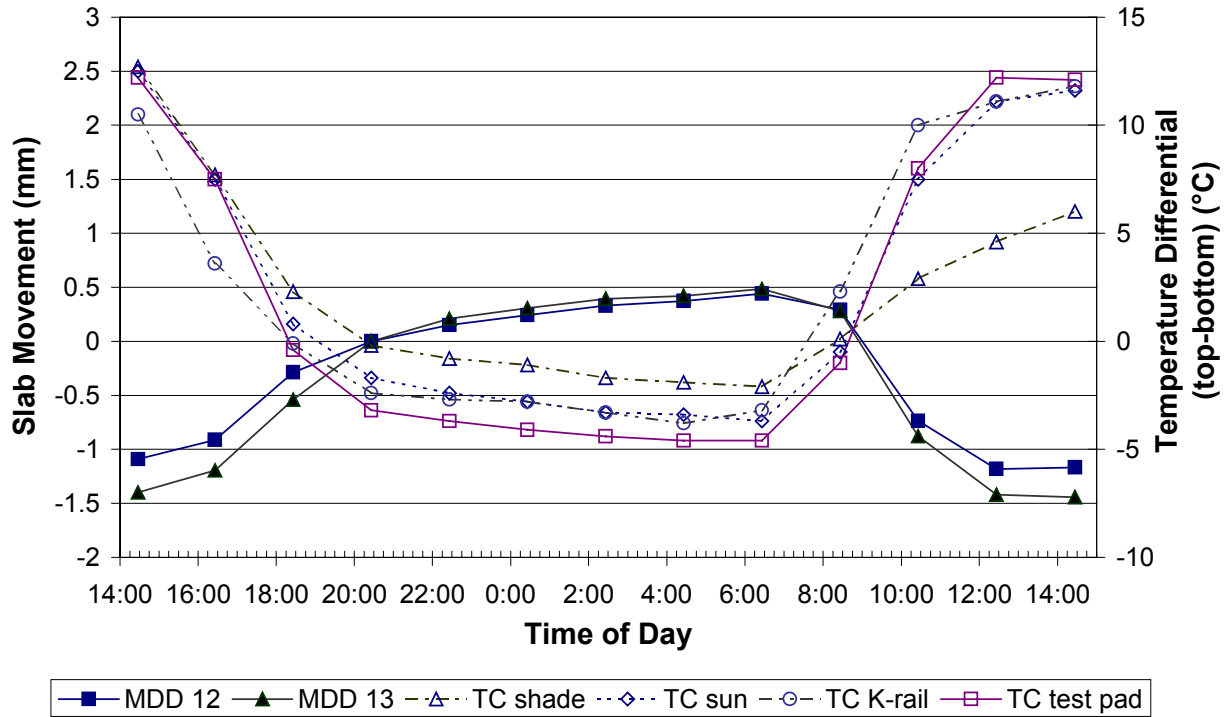

Figure 4.7. Section 534FD MDD results (no HVS, no temperature control chamber).

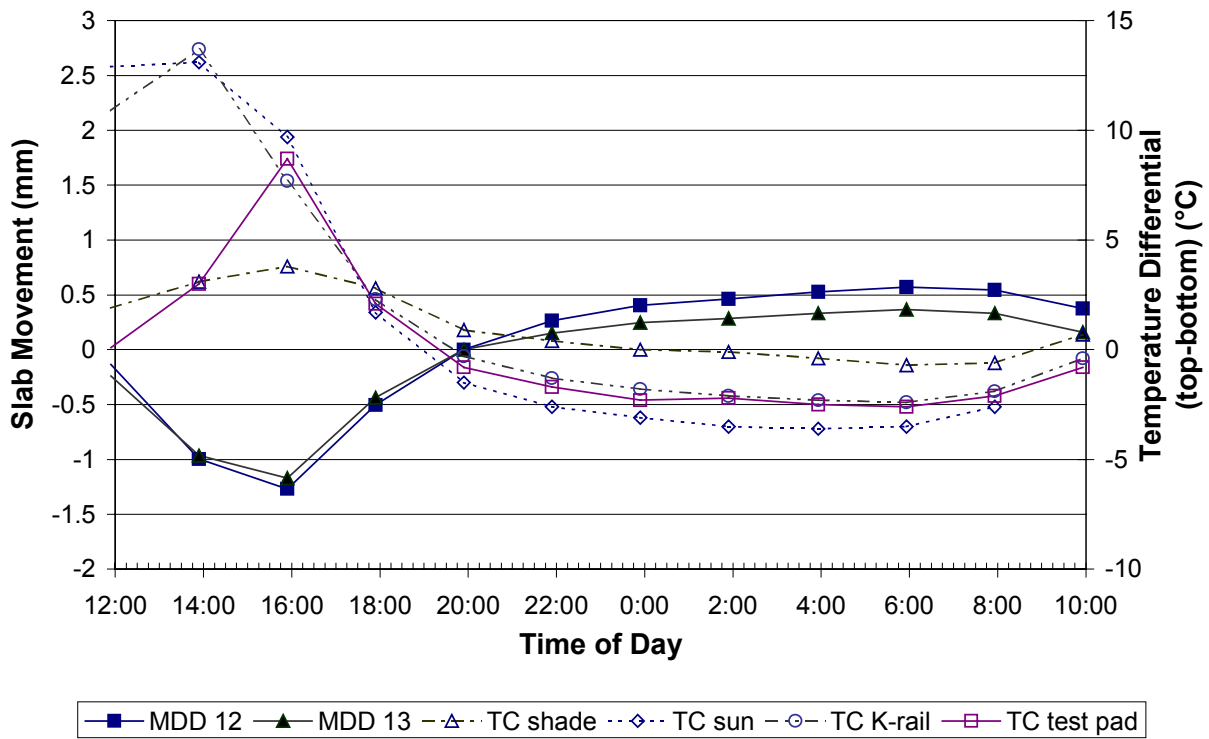

Figure 4.8. Section 534FD MDD results (with HVS, no temperature control chamber)

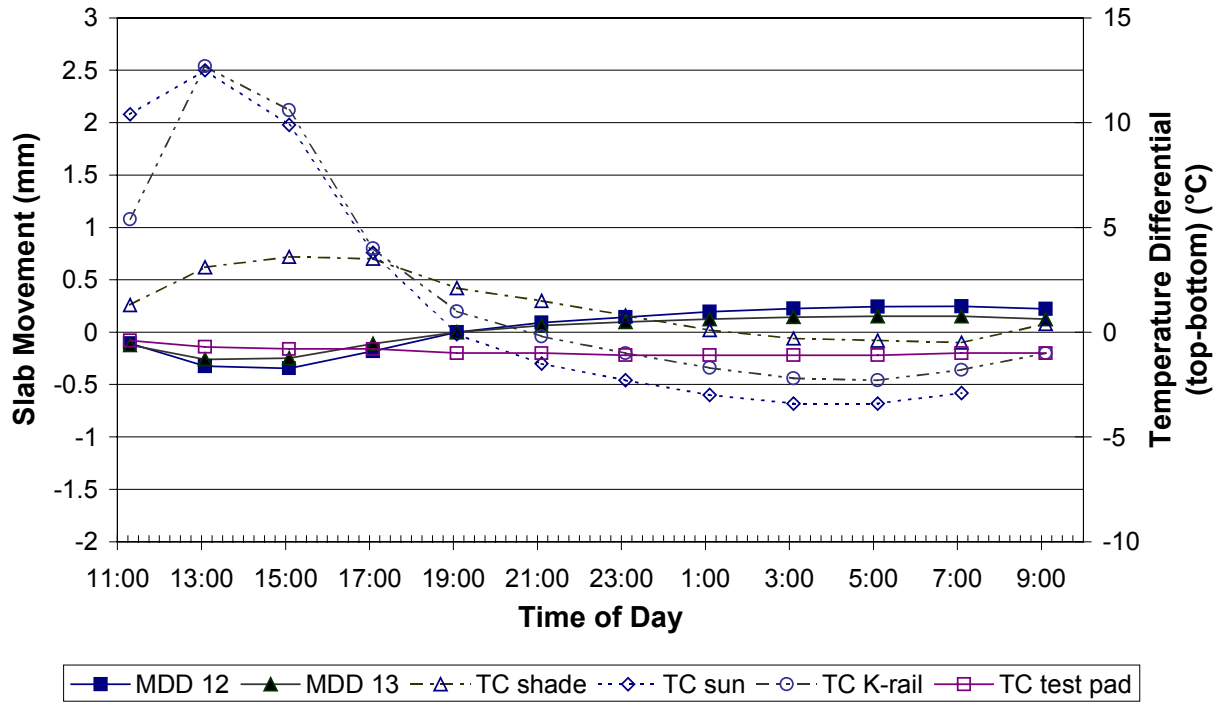

Figure 4.9. Section 534FD MDD results (with HVS and temperature control chamber).

Table 4.5 Section 534FD Summary of MDD Results

MDD 12 & 13: Vertical movements	No HVS on site	HVS on site without temp box	HVS on site with temp box
Max upward movement			
time of day	6:26 AM	5:56 AM	7:06 AM
Outside open air temp (°C)	14.9	14.2	14.8
Air temp inside temp box (°C)		15.1	17.6
Surface temp in sun (°C)	14.7	13.8	13.2
Surface temp inside temp box (°C)		17.2	18.7
Temp difference in sun (°C)	-4.6	-3.5	-2.9
Temp difference inside temp box (°C)		-2.6	-1.0
MDD 12: Max upward movement (mm)	0.442	0.571	0.247
MDD 13: Max upward movement (mm)	0.485	0.365	0.151
Max downward movement			
time of day	2:27 PM	3:54 PM	3:05 PM
Outside open air temp (°C)	27.1	25.1	22.8
Air temp inside temp box (°C)		26.2	21
Surface temp in sun (°C)	35.3	31.9	29.9
Surface temp inside temp box (°C)		30.9	22.1
Temp difference in sun (°C)	12.1	9.7	9.9
Temp difference inside temp box (°C)		8.7	-0.8
MDD 12 Max downward movement (mm)	-1.183	-1.270	-0.346
MDD 13: Max downward movement (mm)	-1.443	-1.172	-0.249
MDD 12: Maximum total movement (mm)	1.625	1.840	0.593
MDD 13: Maximum total movement (mm)	1.928	1.537	0.098
Total temp difference inside temp box (°C)		11.3	0.2
Total temp difference in the sun °C	16.7	13.2	12.8

The strain measurements are shown in Figures 4.10 (no HVS on the test pad), 4.11 (HVS on the test pad without the temperature control chamber), and 4.12 (HVS on the test pad with the temperature control chamber in place and in operation). Table 4.6 summarizes the results.

As in the case of the JDMDs and the MDDs, the strain distributions differ on either side of the zero temperature difference reference point. During the day, due to the large positive temperature differential (top – bottom), the tensile strain is greater than the compression strain that occurs at night.

One explanation for this behavior is that the temperature differentials during the day are much greater than at night. The maximum positive temperature difference (top – bottom) without the influence of the HVS or temperature control (12.1°C) is significantly greater than the maximum negative temperature difference (-2.8°C) under the same conditions.

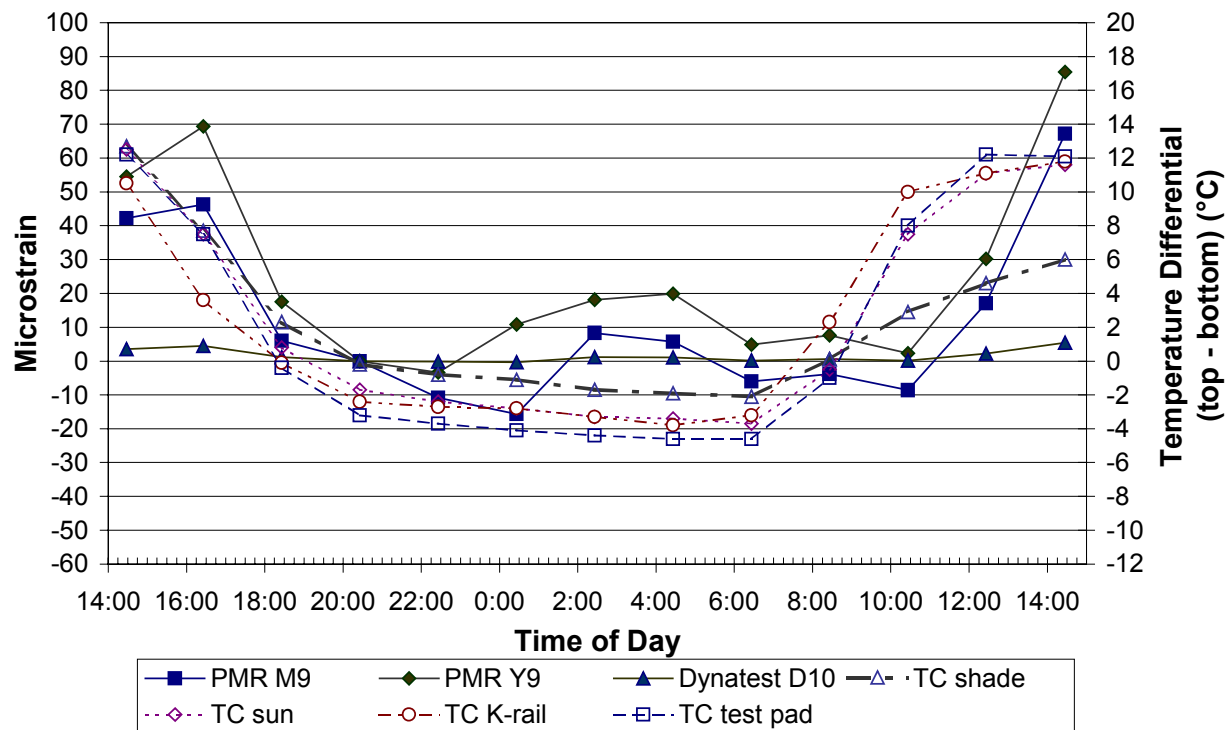

Figure 4.10. Section 534FD strain response (no HVS, no temperature control chamber).

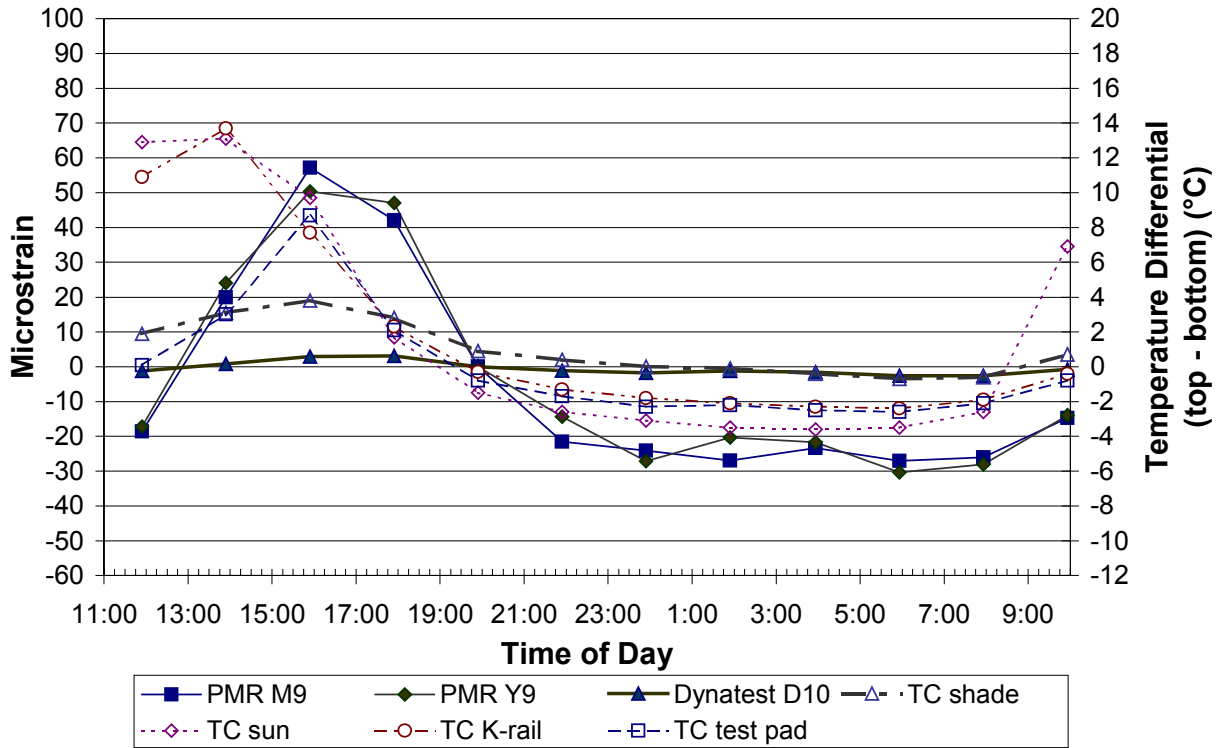

Figure 4.11. Section 534FD strain response (with HVS, no the temperature control chamber).

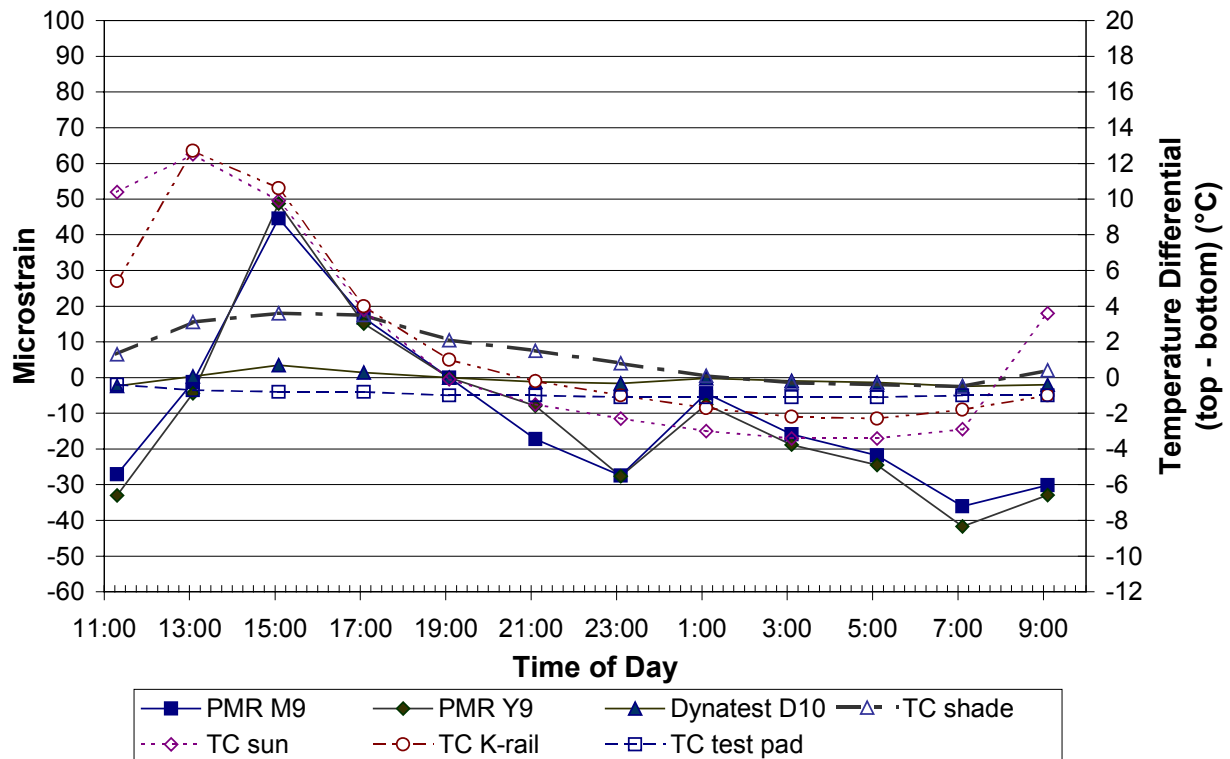

Figure 4.12. Section 534FD strain response (with HVS and temperature control chamber).

Table 4.6 Section 534FD Summary of Strain Gauge Measurements

Strain results	No HVS on site	HVS on site without temp box	HVS on site with temp box
Max compression strain			
time of day	12:26 AM	5:56 AM	7:06 AM
Outside open air temp (°C)	16.4	14.2	14.8
Air temp inside temp box (°C)		15.1	17.6
Surface temp in sun (°C)	16.9	13.8	13.2
Surface temp inside temp box (°C)		17.2	18.7
Temp difference in the sun (°C)	-2.8	-3.5	-2.9
Temp difference inside temp box (°C)		-2.6	-1
PMR M: Max compression strain	-15.654	-27.015	-36.092
PMR Y: Max compression strain		-30.355	-41.711
Dynatest: Max compression strain	-0.324	-2.577	-2.397
Max tensile strain			
time of day	2:27 PM	3:54 PM	3:05 PM
Outside open air temp (°C)	27.1	25.1	22.8
Air temp inside temp box (°C)		26.2	21
Surface temp in sun (°C)	35.3	31.9	29.9
Surface temp inside temp box (°C)		30.9	22.1
Temp difference in the sun (°C)	12.1	9.7	9.9
Temp difference inside temp box (°C)		8.7	-0.8
PMR M: Max tensile strain	67.145	57.102	44.574
PMR Y: Max tensile strain	85.353	50.408	48.746
Dynatest: Max tensile strain	5.392	2.928	3.415
PMR M: Maximum total micro strain	82.799	84.117	80.666
PMR Y: Maximum total micro strain	88.725	80.762	90.457
Dynatest: Maximum total micro strain	-5.068	-0.351	-1.018
Total temp difference in the sun °C	14.9	13.2	12.8
Total temp difference inside temp box (°C)	14.9	11.3	0.2
Max total 24h day to night temperature changes			
Air temp change: outside temp box (°C)	14.7	11.1	8.4
Air temp change: inside temp box (°C)	14.7	11.2	3.4
Surface temp change: outside temp box (°C)	20.6	19.3	16.8
Surface temp change: inside temp box (°C)	20.6	13.8	3.5

Although the shade and temperature control had an influence on the temperature differentials, the total strain variation remained constant (at about 85 μ strain). This finding indicates that the temperature differences outside the temperature-controlled area dominated the strain state and that the temperature-controlled section did not have a significant influence on the measurements. Although there were significant differences in the total maximum day-to-night surface temperatures inside the temperature control chamber for the three cases (20.6°C, 13.8°C, and 3.5°C) the total strain variation through each 24-hour cycle remains constant.

The strain behavior, as detailed in the above tables and graphs, was as anticipated. The PMR gauges, being near the top surface of the concrete slab, experienced a tensile strain during the day when the slab corners were bending downward as a result of the positive temperature differential. The PMR gauges on the upper part of the concrete slab experienced a compression strain during the night when the slab corners were bending upward.

Unfortunately, the Dynatest gauge (being near the bottom of the slab) did not produce reliable results and no conclusion based on this instrument is possible.

4.5 Test 535FD

Test 535FD was a replicate of the test on Section 534FD.

4.5.1 JDMD data

The results of all three cases (without the HVS, with the HVS but without the temperature control chamber, and with the HVS with the temperature control chamber in place) are summarized in Tables 4.7 to 4.9. The complete JDMD movements for the 24-hour cycles are shown in Figures 4.13 to 4.15.

The vertical movements of the edges of the sections were very similar to those of Test 534FD for the “no HVS on site” case. The total JDMD movements in Test 535FD were: 2.2 mm, 2.2 mm, 1.3 mm, 2.3 mm, and 2.6 mm for JDMD 1 to 5, respectively. The corresponding movements for Section 534FD were: 2.3 mm, 2.8 mm, 1.6 mm, 2.1 mm, and 2.5 mm. The maximum total temperature differentials in both tests were also very similar: 16.7°C for Section 534FD and 16.3°C for Section 535FD, and the slab lengths are nearly equal at 3.91 and 3.73 m, respectively. The individual upward and downward movements differed, but it should be

Table 4.7 Section 535FD Summary of JDMD Results (no HVS, no Temperature Control Chamber)

		Critical Case	all JDMD data				
			1	2	3	4	5
JDMD 1 to 5: Vertical edge and corner movements							
Max downward Movement							
time of day	1:41 PM						
Outside air temp (°C)	26.0						
Surface temp (°C)	31.3						
Temp difference at time of max movement (°C)	11.7						
Max downward Movement (mm)	-0.961	-0.961	-0.937	-0.475	-0.860	-0.914	
position	JDMD-1						
Max upward Movement							
time of day	5:41 AM						
Outside air temp (°C)	14.0						
Surface temp (°C)	13.1						
Temp difference (°C)	-4.6						
Max upward Movement (mm)	1.647	1.236	1.267	0.785	1.404	1.647	
position	JDMD-5						
Maximum total movement (mm)	2.561	2.197	2.204	1.261	2.263	2.561	
Total temp difference (top - bottom) (°C)	16.3						
Horizontal slab edge movement JDMD 6							
time of day	1:41 PM						
Outside air temp (°C)	26.0						
Surface temp (°C)	31.3						
Temp difference (°C)	11.7						
Max Closing Movement (mm)	0.137						
time of day	7:41 AM						
Outside air temp (°C)	14.4						
Surface temp (°C)	13.0						
Temp difference (°C)	-3.8						
Max opening Movement (mm)	-0.3601						
Max total joint horizontal movement (mm)	0.497						
Total temp difference (top-bottom) (°C)	15.5						
Max total 24h day to night temperature changes							
Air temp change: outside temp box (°C)	12.7						
Air temp change: inside temp box (°C)	12.7						
Surface temp change: outside temp box (°C)	18.3						
Surface temp change: inside temp box (°C)	18.3						

Table 4.8 Section 535FD Summary of JDMD Results (with HVS, without Temperature Control Chamber)

		Critical Case	all JDMD data				
			1	2	3	4	5
JDMD 1 to 5: Vertical edge and corner movements							
Max downward Movement							
time of day	2:35 PM						
Outside open air temp (°C)	14.9						
Air temp: under the HVS (°C)	14.9						
Surface temp away fom HVS (°C)	21.9						
Surface temp under HVS (°C)	18.9						
Temp difference (°C) away from HVS	4.0						
Temp difference (°C) under HVS	2.4						
Max downward Movement (mm)	-0.124	-0.036	-0.029	-0.059	-0.124	-0.121	
position	JDMD-4						

Max upward movement							
time of day	4:35 AM						
Outside air temp in open air	9.3						
Air temp: under the HVS	9.2						
Surface temp away fom HVS	9.3						
Surface temp under HVS	10.7						
Temp difference (°C) away from HVS	-5.4						
Temp difference (°C) under HVS	-4.3						
Max upward Movement (mm)	1.274	0.997	1.070	0.709	1.143	1.274	
position	JDMD-5						
Max total movement (mm)	1.398	1.033	1.099	0.768	1.267	1.395	
Total temp difference (top - bottom) under HVS (°C)	6.7						

Horizontal slab edge movement	
time of day	2:35 PM
Outside air temp in open air (°C)	14.9
Air temp: under the HVS (°C)	14.9
Surface temp away fom HVS (°C)	21.9
Surface temp under HVS (°C)	18.9
Temp difference (°C) away from HVS	4.0
Temp difference (°C) under HVS	2.4
Max Closing Movement (mm)	-0.046
time of day	6:35 AM
Outside air temp in open air (°C)	9.0
Air temp: under the HVS (°C)	9.3
Surface temp away fom HVS (°C)	9.1
Surface temp under HVS (°C)	10.8
Temp difference (°C) away from HVS	-5.1
Temp difference (°C) under HVS	-3.8
Max opening Movement (mm)	-0.361
Max total joint horizontal movement (mm)	0.315
Total temp difference (top - bottom) under HVS (°C)	6.2

Max total 24h day to night temperature changes	
Air temp change: outside temp box (°C)	11.5
Air temp change: inside temp box (°C)	12.8
Surface temp change: outside temp box (°C)	18.0
Surface temp change: inside temp box (°C)	8.2

Table 4.9 Section 535FD Summary of JDMD Results (with HVS and Temperature Control Chamber)

		Critical Case	all JDMD data				
			1	2	3	4	5
JDMD 1 to 5: Vertical edge and corner movements							
Max downward Movement							
time of day	2:27 PM						
Outside open air temp (°C)	26.7						
Air temp: under the HVS (°C)	22.2						
Surface temp away fom HVS (°C)	36.0						
Surface temp under HVS (°C)	20.6						
Temp difference (°C) away from HVS	10.3						
Temp difference (°C) under HVS	0.8						
Max downward Movement (mm)	-0.166	-0.125	-0.120	-0.061	-0.152	-0.166	
position	JDMD-5						
Max upward movement							
time of day	8:27 AM						
Outside air temp in open air	13.7						
Air temp: under the HVS	15.9						
Surface temp away fom HVS	15.5						
Surface temp under HVS	16.5						
Temp difference (°C) away from HVS	1.0						
Temp difference (°C) under HVS	-0.1						
Max upward Movement (mm)	0.350	0.278	0.269	0.202	0.335	0.350	
position	JDMD-5						
Max total movement (mm)	0.516	0.403	0.390	0.263	0.487	0.516	
Total temp difference (top - bottom) under HVS (°C)	0.9						
Horizontal slab edge movement							
time of day	4:27 PM						
Outside air temp in open air (°C)	24.3						
Air temp: under the HVS (°C)	21.5						
Surface temp away fom HVS (°C)	28.4						
Surface temp under HVS (°C)	21.5						
Temp difference (°C) away from HVS	4.6						
Temp difference (°C) under HVS	1.1						
Max Closing Movement (mm)	0.004						
time of day	10:27 AM						
Outside air temp in open air (°C)	22.6						
Air temp: under the HVS (°C)	17.8						
Surface temp away fom HVS (°C)	30.5						
Surface temp under HVS (°C)	19.2						
Temp difference (°C) away from HVS	8.9						
Temp difference (°C) under HVS	0.1						
Max opening Movement (mm)	-0.060						
Max total joint horizontal movement (mm)	0.064						
Total temp difference (top - bottom) under HVS (°C)	1.0						
Max total 24h day to night temperature changes							
Air temp change: outside temp box (°C)	13.1						
Air temp change: inside temp box (°C)	6.3						
Surface temp change: outside temp box (°C)	21.9						
Surface temp change: inside temp box (°C)	4.1						

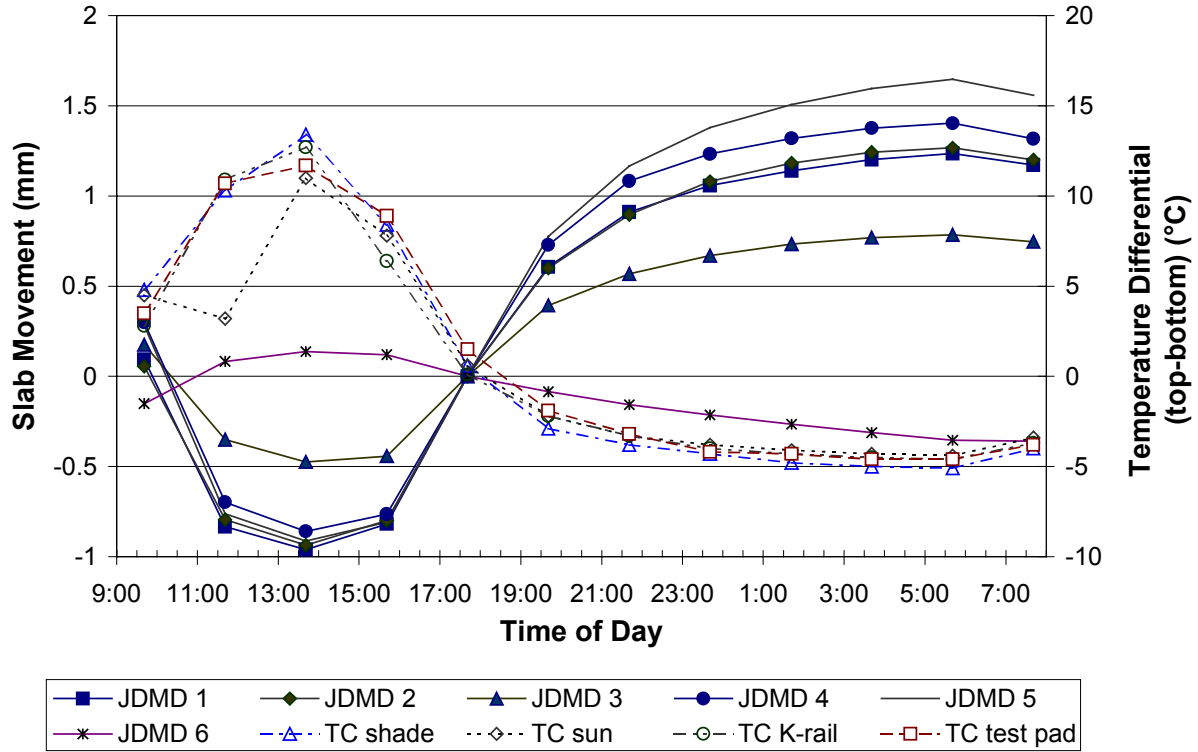

Figure 4.13. Section 535FD JDMD results (no HVS, no temperature control chamber).

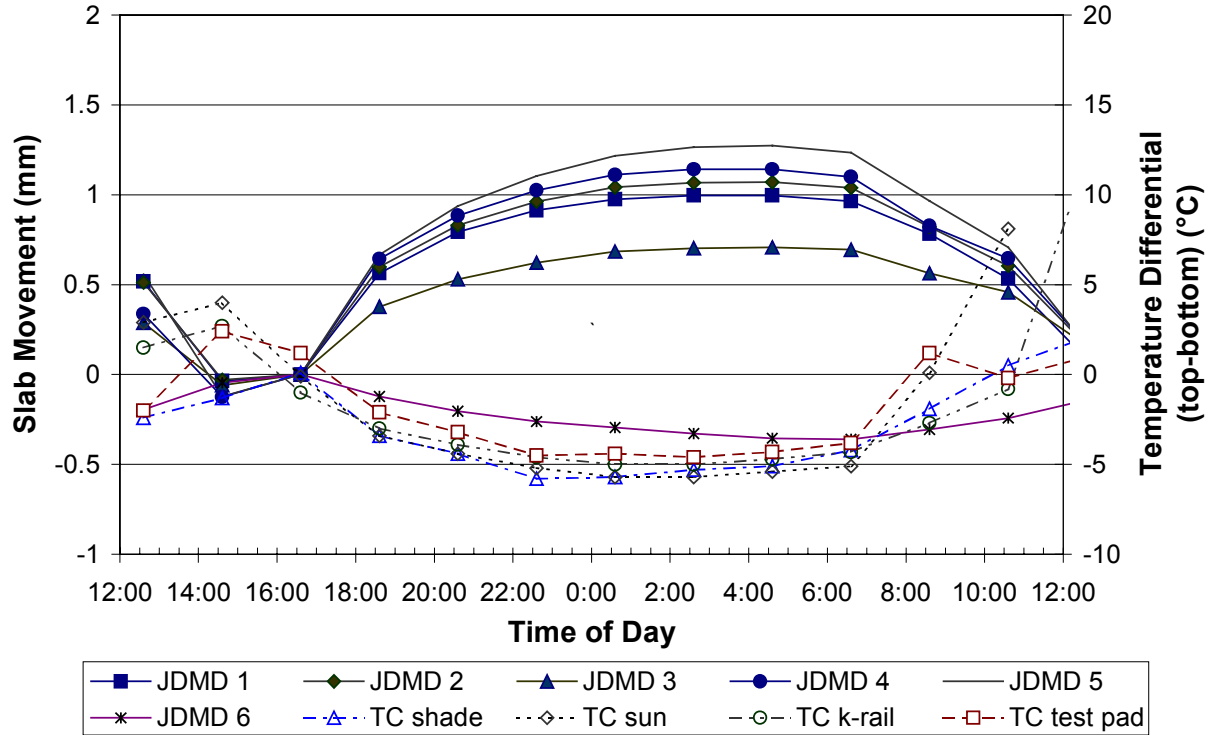

Figure 4.14. Section 535FD JDMD results (with HVS, no temperature control chamber).

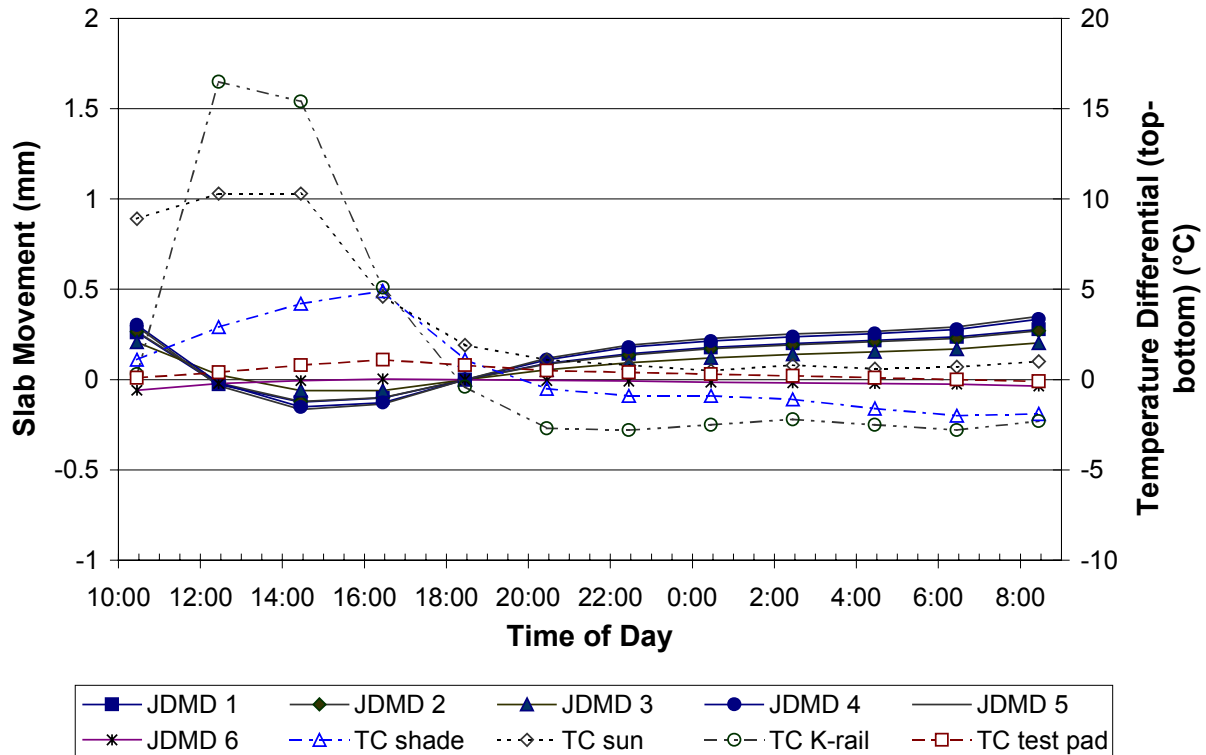

Figure 4.15. Section 535FD JDMD results (with HVS and temperature control chamber).

remembered that the upward and downward movements depend on the definition used for the reference point.

The horizontal movements for the “No HVS on site” case in these two tests, as recorded by JDMD 6, also differed. Although the maximum temperature differentials (15.5°C for 535FD and 16.7°C for 534FD) and the total day-to-night temperature change (18.3°C for 535FD and 20.6°C for 534FD) were similar, the total horizontal movement on Section 535FD was approximately half that measured on Section 534FD (0.497 mm compared to 0.902 mm).

The slab lengths, on either side of the of the joint across which the horizontal slab movement was measured, were different:

- 3.7 m and 3.7 m for Test 534FD, and
- 3.65 m and 5.25 m for Test 535FD

The 5.25-m slab contained a transverse shrinkage crack, which reduce its effective length. The cracked slabs on 535FD are probably the reason for the reduced horizontal slab movement. Interaction of the horizontal movements of slabs is not necessarily uniform, depending on joint contact, local friction with the base and adjacent lane, as well as slab length.

In the case of the HVS on the section without the temperature control chamber, comparison of the measurements on Sections 534FD and 535FD yielded the following conclusions:

- The total vertical movements in Section 535FD were less than those in Section 534FD. The likely explanation for this behavior and the results recorded by JDMD 6 is that the maximum daytime temperature in Test 534FD was significantly higher than in Test 535FD. In Test 534FD, the outside surface temperature at the time of maximum movement was 35.3°C in comparison to 26.0°C in Test 535FD. A likely cause of the reduced joint movement on Test 535FD was joint lock-up caused by the higher temperatures. Once lock-up was reached, the slabs were in either compression, or pushing adjacent slabs. In addition, this lower surface temperature resulted in a smaller temperature differential across the thickness of the slab, which, in turn, caused a lower vertical downward bending movement. The maximum total temperature differentials under the HVS for Tests 535FD and 534FD were 6.7°C and 11.3°C respectively.
- A similar trend was observed with the horizontal movement. The maximum horizontal movement during Test 535FD was 0.32 mm. For Test 534FD, the maximum horizontal movement was 1.10 mm.

- In the case of Test 535FD with the HVS and the temperature control chamber (Table 4.9), there was good temperature control inside the chamber, where the maximum surface temperature change was only 0.9°C during the 24 hours, in comparison with the maximum total temperature change of 16.3°C which was recorded when the section was completely exposed to the sun. A maximum movement of 0.516 mm was recorded by JDMD 5 during the 24-hour cycle. These results are very similar to those for Test 534FD under the same conditions (with the HVS and the temperature control chamber). Because the overall slab temperatures were reduced by the temperature control chamber from 31.3°C to 16.5°C (Tables 4.7 and 4.9), the joint did not lock up and the joint opening was fully controlled by the temperatures and base friction.

The JDMD results of all cases for Test 535FD are summarized in Table 4.10.

Table 4.10 Section 535FD Summary of All JDMD Results

	No HVS	With HVS	With HVS and temperature chamber
Total max movement (mm)			
Vertical edge & corner movement	2.561	1.398	0.516
Horizontal transverse joint movement	0.497	0.315	0.064
Maximum temperature differences) (°C)			
On the test section (top - bottom)	16.3	6.7	0.9
In the sun (top - bottom)	16.3	9.4	9.3
Day to night air temperature change	12.7	12.8	6.3

These results compare favorably with those produced in Test 534FD (see Table 4.4).

4.5.2 MDD data

The MDD responses for the three cases are displayed graphically in Figures 4.16 to 4.18 and are summarized in Table 4.11. One important observation relates to the times at which the MDDs recorded their peak movements. Except for the “No HVS” case, the MDDs consistently recorded their upward peak deflections later than the JDMDs. (Compare Tables 4.8 and 4.9 with Table 4.11).

One reason for this may be that the MDDs were placed 300 mm from the edge of the slab, whereas the JDMDs were right at the edge. The significance of this is that the peak MDD movements were recorded at times when the temperature was not at its minimum. For example, in the case of Test 535FD with the HVS on the section but without the temperature control chamber, the JDMD recorded a maximum upward movement of 1.27 mm when the temperature differential under the HVS was -4.3°C (at 4:35 a.m.). At that time (4:35 a.m.), the MDD had not yet recorded its peak movement. The maximum MDD movement was only recorded six hours later, at 10:36 a.m.

Another important observation is that although the movements were small, the temperatures outside the temperature control chamber had an influence on the slab movement inside the chamber (see Figure 4.18). Although the temperature control inside the chamber was good, the MDD measurements inside the concrete slab (level one, 100 mm from the top) followed the same trend as those of the thermocouples placed outside the temperature control chamber, the only difference being the time lag between the time at which the outside temperature differential was at its maximum and the time at which the MDDs recorded their maximum movement. The time lag is likely due to the time for the heat to transfer from adjacent slabs to the instrumented slab.

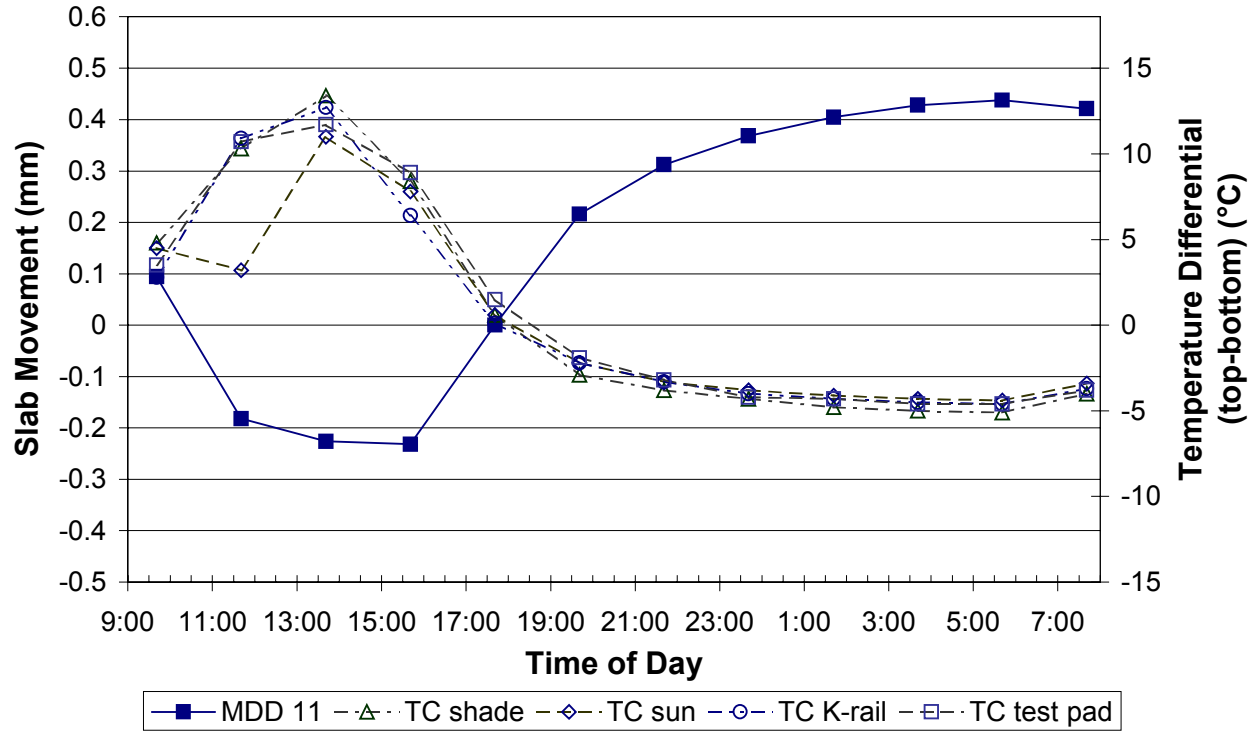

Figure 4.16. Section 535FD MDD results (no HVS, no temperature control chamber).

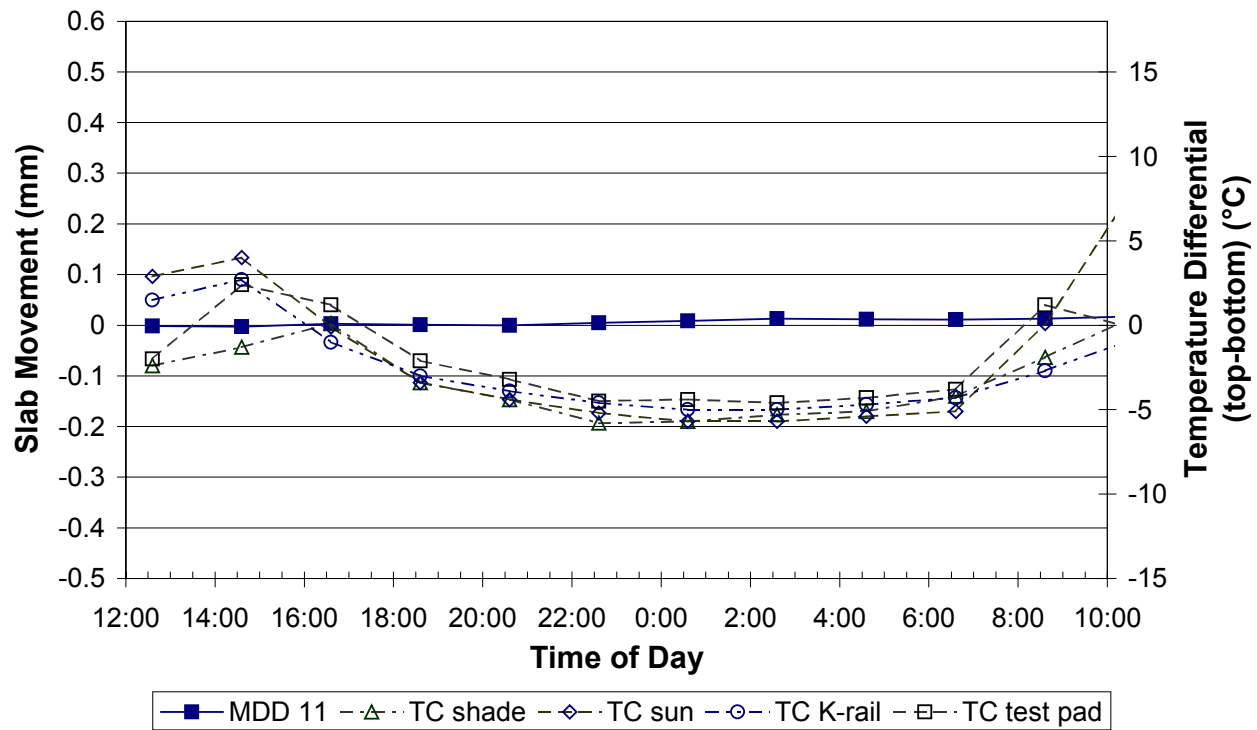

Figure 4.17. Section 535FD MDD results (with HVS, no temperature control chamber).

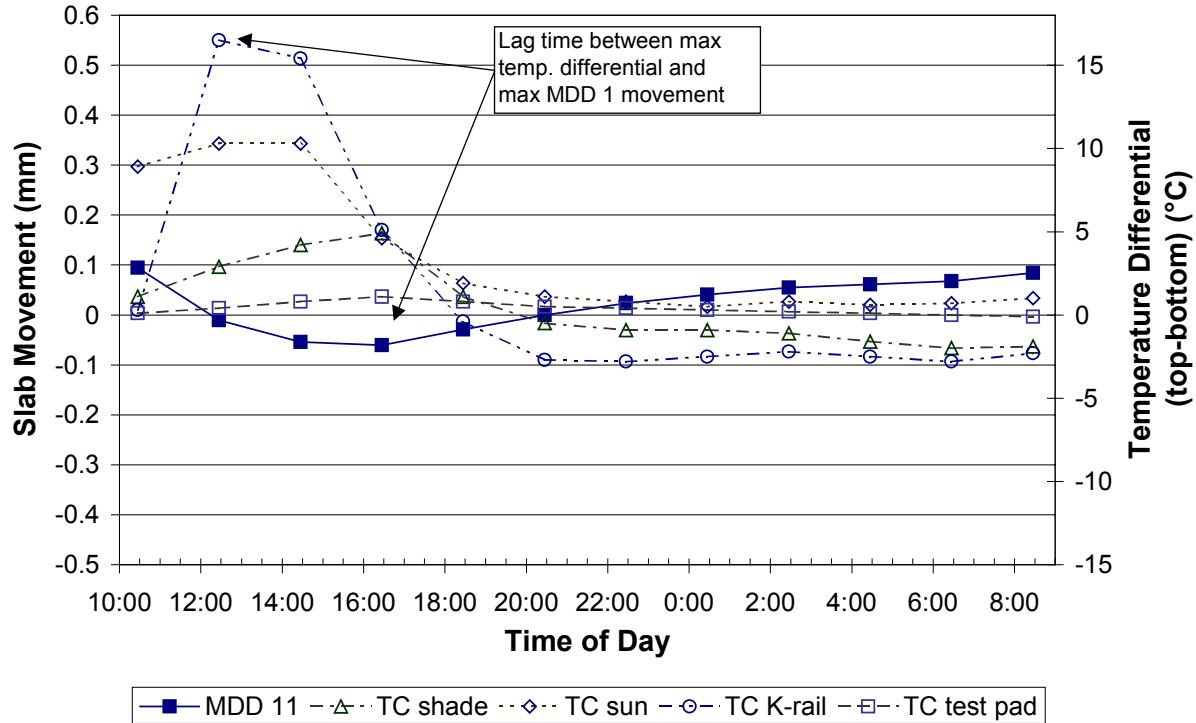

Figure 4.18. Section 535FD MDD results (with HVS and temperature control chamber).

Table 4.11 Section 535FD Summary of MDD Results

MDD 11: Vertical movements	No HVS on site	HVS on site without temp box	HVS on site with temp box
Max upward movement			
time of day	5:41 AM	10:36 AM	10:27 AM
Outside open air temp (°C)	14.1	17.1	22.6
Air temp inside temp box (°C)	14.1	17.1	17.8
Surface temp in sun (°C)	13.1	23.6	30.5
Surface temp inside temp box (°C)	13.1	15.8	17.2
Temp difference in sun (°C)	-4.4	8.1	8.9
Temp difference inside temp box (°C)	-4.6	-0.2	0.1
MDD 11: Max upward movement (mm)	0.438	0.014	0.094
Max downward movement			
time of day	3:41 PM	2:36 PM	4:27 PM
Outside open air temp (°C)	26.7	14.9	24.3
Air temp inside temp box (°C)	28.4	14.9	21.5
Surface temp in sun (°C)	29.3	21.9	28.4
Surface temp inside temp box (°C)	29.3	18.9	20.2
Temp difference in sun (°C)	7.8	4.0	4.6
Temp difference inside temp box (°C)	8.9	2.4	1.1
MDD 11 Max downward movement (mm)	-0.231	-0.0058	-0.060
MDD 11: Maximum total movement (mm)	0.669	0.020	0.154
Total temp difference inside temp box (°C)		2.6	1.0
Total temp difference in the sun °C	12.2	-4.1	-4.3

As expected, the MDD movements are smaller than those measured by the JDMDs. It also seems that some of the thermocouples may have recorded some erroneous results (especially the TC Sun thermocouple).

If the MDD data from Test 534FD are compared with those from Test 535FD (Tables 4.5 and 4.11), it is clear that the movements recorded in Test 535FD are significantly smaller than those produced in Test 534FD. This difference is due to the position of the MDDs. On Test 534FD, the MDDs were placed close to the joint of two adjacent slabs where the up and down movements are significantly greater than those measured at the midpoint position. On Test 535FD, MDD 11 was placed at the midpoint position near the edge of Slab 32 (Figure 3.2).

4.5.3 Strain data

Strain gauges were placed according to the layout shown in Figure 3.3 and are explained in Section 3.1.3. The data are shown in Figures 4.19 to 4.21 for the three cases investigated. All gauges were placed close to Joint 32 with the Dynatest gauges (D8 and D9) being placed approximately 50 mm from the bottom and the PMR gauges (P7 and P8) the same distance from the top of the slab.

Figure 4.19 presents the strain response for the case in which the whole test section was exposed to direct sunlight. The Dynatest gauges went through a cycle of being in compression during the day (periods of positive temperature gradients) to tension during the night (periods of negative temperature gradients). The maximum compression strain was 223 μ strain, which was caused by a positive temperature differential of 13.2°C. The maximum tensile strain of 255 μ was achieved during a temperature differential of -5.1°C. This behavior is in agreement with

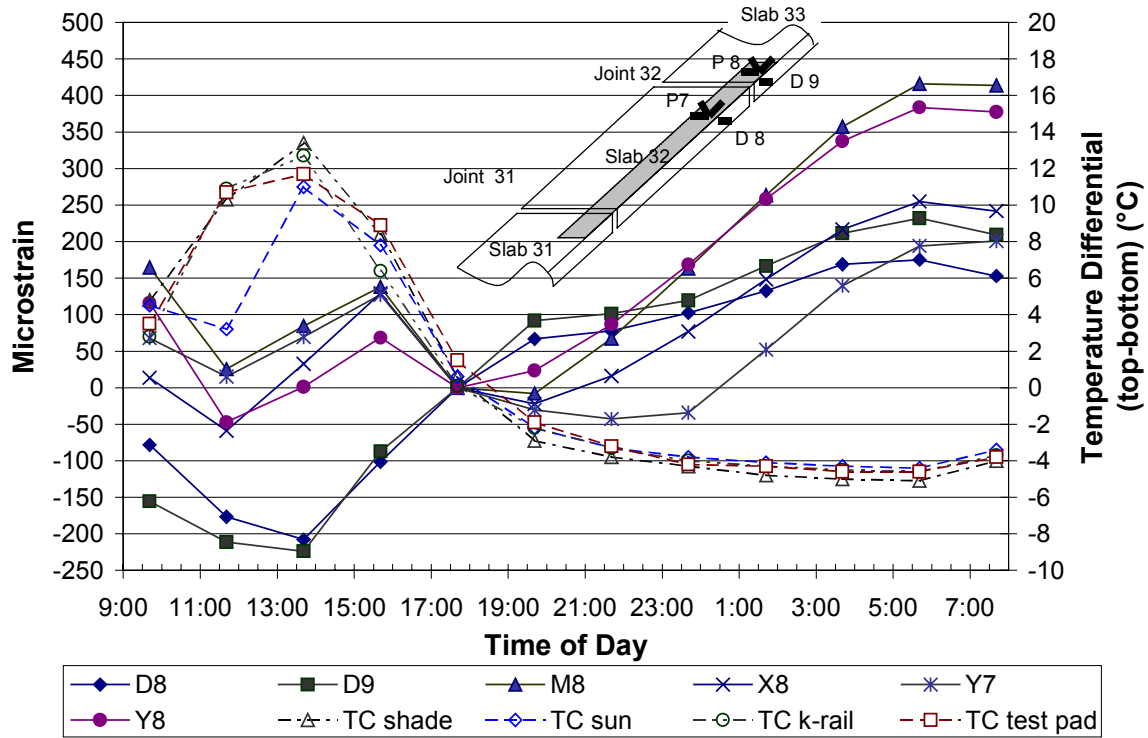

Figure 4.19. Section 535FD strain response (no HVS, no temperature control chamber).

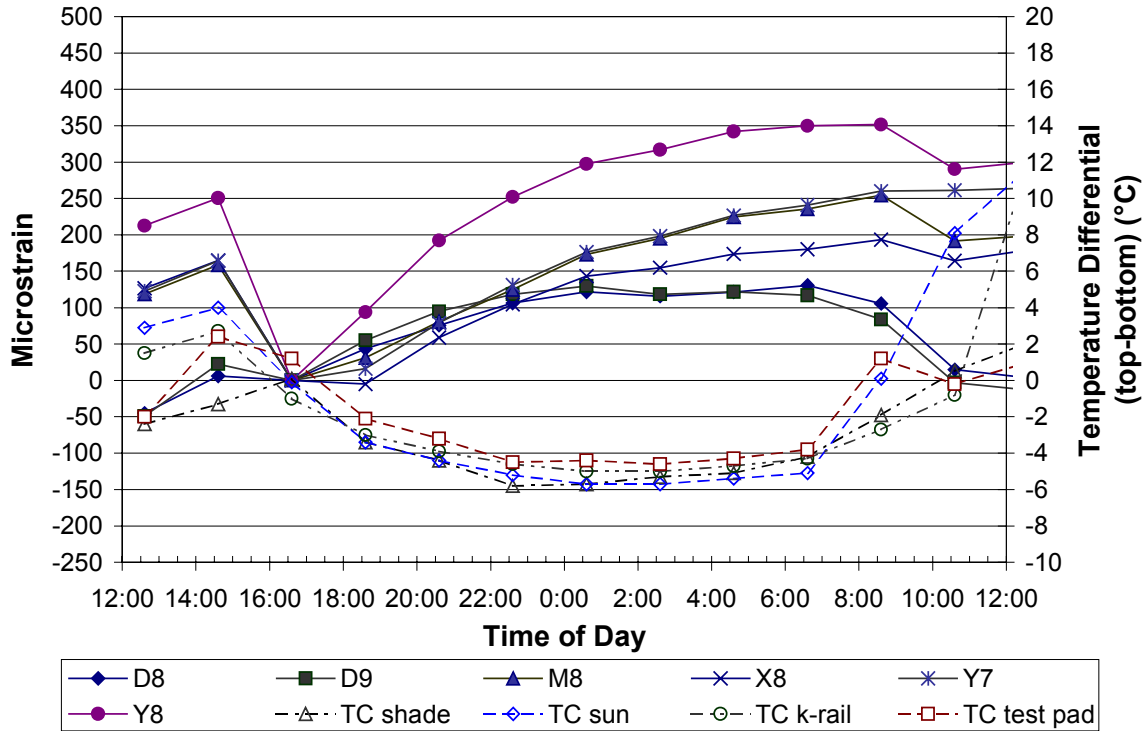

Figure 4.20. Section 535FD strain response (with HVS, no temperature control chamber).

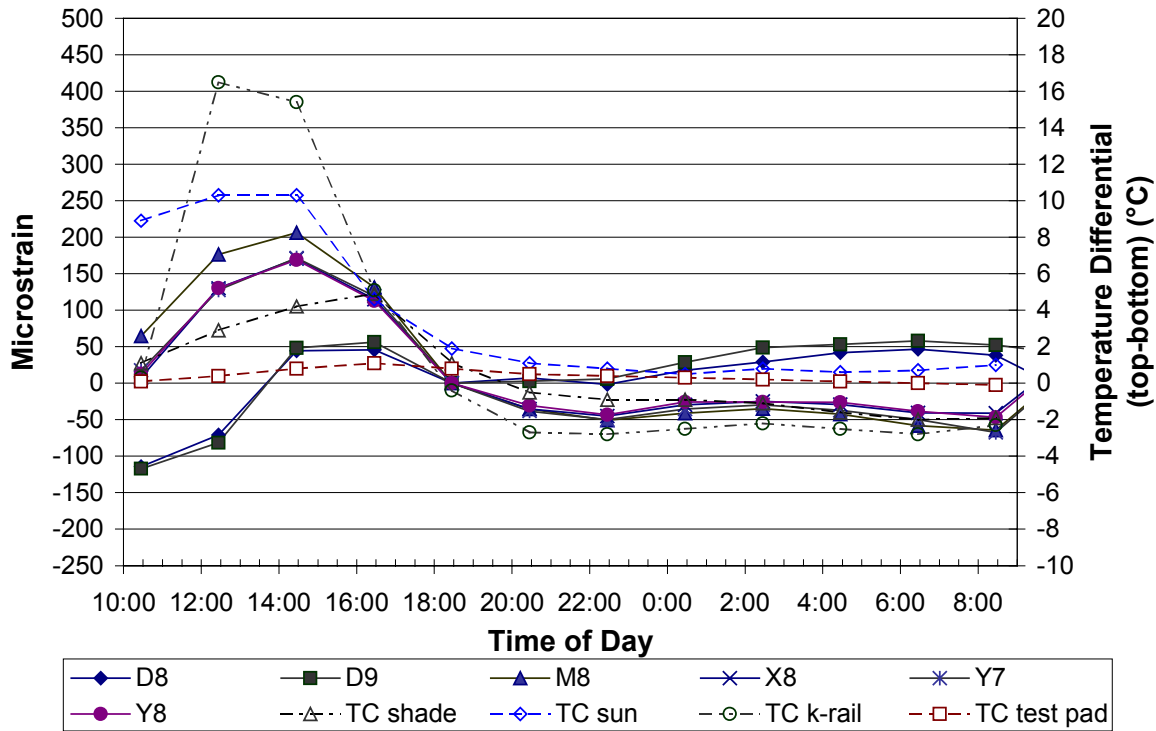

Figure 4.21. Section 535FD strain response (with HVS and temperature control chamber).

what is expected: the bottom of the concrete slab should contract when the slab is cooler on the bottom and vice versa.

Initially, the PMR gauges were in tension during the day (as expected) but went further into tension during the night (not as expected).

The strains recorded when temperature control was exercised reveals some interesting results:

- Although good temperature control was exercised inside the chamber (maximum temperature difference = 1.1°C — see Figure 4.21), strains as high as 206 μ strain were recorded. More interesting is the fact that the strains recorded by the various strain gauges follow the same trend as the thermocouple readings outside the

temperature control chamber. It is obvious that the strain built up inside the chamber was heavily influenced by the slab corners curl outside the chamber.

- The strain behavior is as expected: The bottom strain gauges (Dynatest D8 and D9) were in compression during times of a positive temperature differential (day) and in tension during times of a negative temperature differential (night). The opposite is observed for the strain gauges placed near the top of the slab. They were in tension during the day and went into compression during the night.

4.6 Test 536FD

Test 536FD was conducted on concrete slabs, which had dowels and tie bars in them (see Section 3.0). It is therefore anticipated that the vertical movements resulting from temperature differentials (top – bottom) will be restricted because there are no free-moving edges on this test section. The results from the various instruments are discussed below.

4.6.1 JDMD data

The results of all three cases (without the HVS, with the HVS but without the temperature control chamber, and with the HVS with the temperature control chamber in place) are summarized in Tables 4.12 to 4.14. The total JDMD movements over the 24-hour cycle can be seen in Figures 4.22 to 4.24. The results from all three cases are summarized in Table 4.15.

Figures 4.22 through 4.24 show the significant effects of the tie bars and dowels. In the most critical case (no HVS, no temperature control chamber), the maximum vertical movement was only 0.6 mm, even though a total temperature differential of 15.2°C was recorded. This is significantly less than the vertical movements recorded in Test 535FD, where the maximum

Table 4.12 Section 536FD Summary of JDMD Results (no HVS, no Temperature Control Chamber)

		Critical Case	all JDMD data				
			1	2	3	4	5
JDMD 1 to 5: Vertical edge and corner movements							
Max downward Movement							
time of day	1:32 PM						
Outside air temp (°C)	32.3						
Surface temp (°C)	34.6						
Temp difference at time of max movement (°C)	11.7						
Max downward Movement (mm)	-0.3357	-0.178	-0.267	-0.181	-0.271	-0.336	
position	JDMD-5						
Max upward Movement							
time of day	5:28 AM						
Outside air temp (°C)	18.9						
Surface temp (°C)	17.6						
Temp difference (°C)	-3.5						
Max upward Movement (mm)	0.3630	0.363	0.264	0.018	0.261	0.236	
position	JDMD-1						
Maximum total movement (mm)	0.5712	0.541	0.531	0.199	0.532	0.571	
Total temp difference (top - bottom) (°C)	15.2						
Horizontal slab edge movement JDMD 6							
time of day	3:28 PM						
Outside air temp (°C)	30.9						
Surface temp (°C)	36.0						
Temp difference (°C)	12.6						
Max Closing Movement (mm)	0.3714						
time of day	5:28 AM						
Outside air temp (°C)	18.9						
Surface temp (°C)	17.6						
Temp difference (°C)	-3.5						
Max opening Movement (mm)	-0.0779						
Max total joint horizontal movement (mm)	0.449						
Total temp difference (top-bottom) (°C)	16.1						
Max total 24h day to night temperature changes							
Air temp change: outside temp box (°C)	12.0						
Air temp change: inside temp box (°C)	12.0						
Surface temp change: outside temp box (°C)	18.2						
Surface temp change: inside temp box (°C)	18.4						

Table 4.13 Section 536FD Summary of JDMD Results (with HVS, without Temperature Control Chamber)

		all JDMD data				
		1	2	3	4	5
JDMD 1 to 5: Vertical edge and corner movements						
Max downward Movement						
time of day	1:09 PM					
Outside open air temp (°C)	21.8					
Air temp: under the HVS (°C)	22.4					
Surface temp away fom HVS (°C)	34.2					
Surface temp under HVS (°C)	39.9					
Temp difference (°C) away from HVS	5.7					
Temp difference (°C) under HVS	1.9					
Max downward Movement (mm)	-0.246	-0.021	-0.050	-0.246	-0.105	-0.087
position	JDMD-3					

Max upward movement						
time of day	7:10 AM					
Outside air temp in open air	18.4					
Air temp: under the HVS	18.3					
Surface temp away fom HVS	16.0					
Surface temp under HVS	18.6					
Temp difference (°C) away from HVS	1.6					
Temp difference (°C) under HVS	-1.3					
Max upward Movement (mm)	0.072	0.072	0.056	-0.071	0.052	0.032
position	JDMD-4					
Max total movement (mm)	0.175	0.093	0.106	0.175	0.156	0.119
Total temp difference (top - bottom) under HVS (°C)	3.2					

Horizontal slab edge movement	
time of day	5:10 PM
Outside air temp in open air (°C)	26.5
Air temp: under the HVS (°C)	27.0
Surface temp away fom HVS (°C)	30.1
Surface temp under HVS (°C)	25.5
Temp difference (°C) away from HVS	9.7
Temp difference (°C) under HVS	3.9
Max Closing Movement (mm)	0.075
time of day	7:10 AM
Outside air temp in open air (°C)	18.4
Air temp: under the HVS (°C)	18.3
Surface temp away fom HVS (°C)	16.0
Surface temp under HVS (°C)	18.6
Temp difference (°C) away from HVS	1.6
Temp difference (°C) under HVS	-1.3
Max opening Movement (mm)	-0.103
Max total joint horizontal movement (mm)	0.178
Total temp difference (top - bottom) under HVS (°C)	5.2

Max total 24h day to night temperature changes	
Air temp change: outside temp box (°C)	9.5
Air temp change: inside temp box (°C)	9.2
Surface temp change: outside temp box (°C)	21.0
Surface temp change: inside temp box (°C)	7.4

Table 4.14 Section 536FD Summary of JDMD Results (with HVS and Temperature Control Chamber)

		Critical Case	all JDMD data				
			1	2	3	4	5
JDMD 1 to 5: Vertical edge and corner movements							
Max downward Movement							
time of day	2:12 PM						
Outside open air temp (°C)	13.0						
Air temp: under the HVS (°C)	19.4						
Surface temp away fom HVS (°C)	21.7						
Surface temp under HVS (°C)	19.6						
Temp difference (°C) away from HVS	6.4						
Temp difference (°C) under HVS	-0.5						
Max downward Movement (mm)	-0.367	-0.196	-0.212	-0.039	-0.367	-0.246	
position	JDMD 4						

Max upward movement							
time of day	8:12 AM						
Outside air temp in open air	9.3						
Air temp: under the HVS	12.8						
Surface temp away fom HVS	10.5						
Surface temp under HVS	15.1						
Temp difference (°C) away from HVS	-4.7						
Temp difference (°C) under HVS	-2.3						
Max upward Movement (mm)	0.041	0.028	0.026	0.014	0.041	0.028	
position	JDMD 4						
Max total movement (mm)	0.408	0.224	0.238	0.053	0.408	0.275	
Total temp difference (top - bottom) under HVS (°C)	1.8						

Horizontal slab edge movement							
time of day	2:12 PM						
Outside air temp in open air (°C)	13.0						
Air temp: under the HVS (°C)	19.4						
Surface temp away fom HVS (°C)	21.7						
Surface temp under HVS (°C)	19.6						
Temp difference (°C) away from HVS	6.4						
Temp difference (°C) under HVS	-0.5						
Max Closing Movement (mm)	0.054						
time of day	8:12 AM						
Outside air temp in open air (°C)	9.3						
Air temp: under the HVS (°C)	12.8						
Surface temp away fom HVS (°C)	10.5						
Surface temp under HVS (°C)	15.1						
Temp difference (°C) away from HVS	-4.7						
Temp difference (°C) under HVS	-2.3						
Max opening Movement (mm)	-0.028						
Max total joint horizontal movement (mm)	0.082						
Total temp difference (top - bottom) under HVS (°C)	1.8						

Max total 24h day to night temperature changes	
Air temp change: outside temp box (°C)	9.0
Air temp change: inside temp box (°C)	6.8
Surface temp change: outside temp box (°C)	19.5
Surface temp change: inside temp box (°C)	4.5

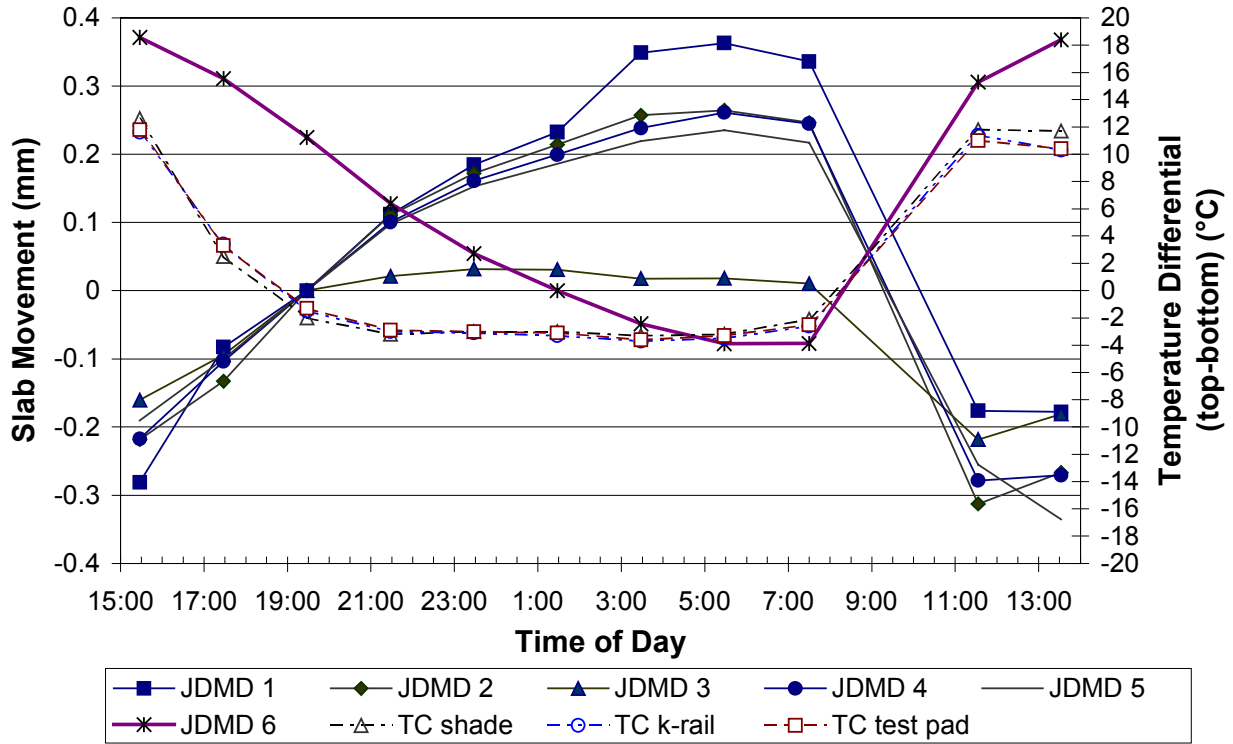

Figure 4.22. Section 536FD JDMD results (no HVS, no temperature control chamber).

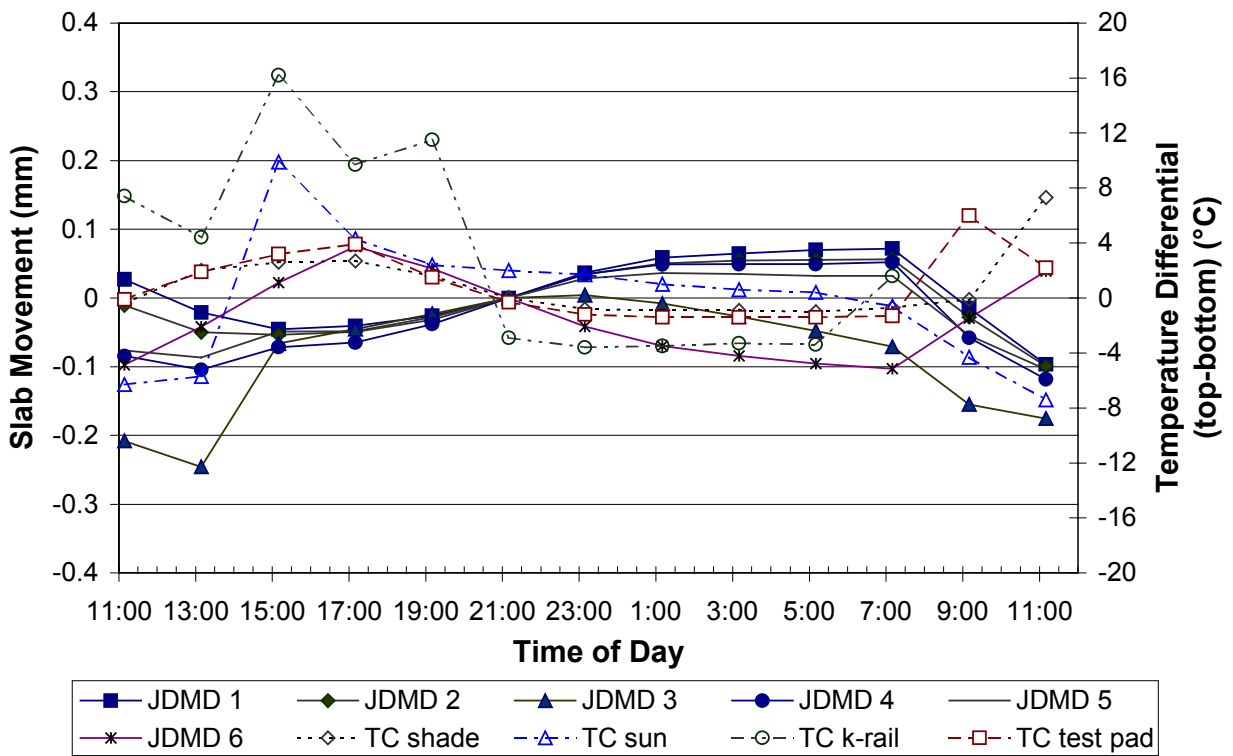

Figure 4.23. Section 536FD JDMD results (with HVS, no temperature control chamber).

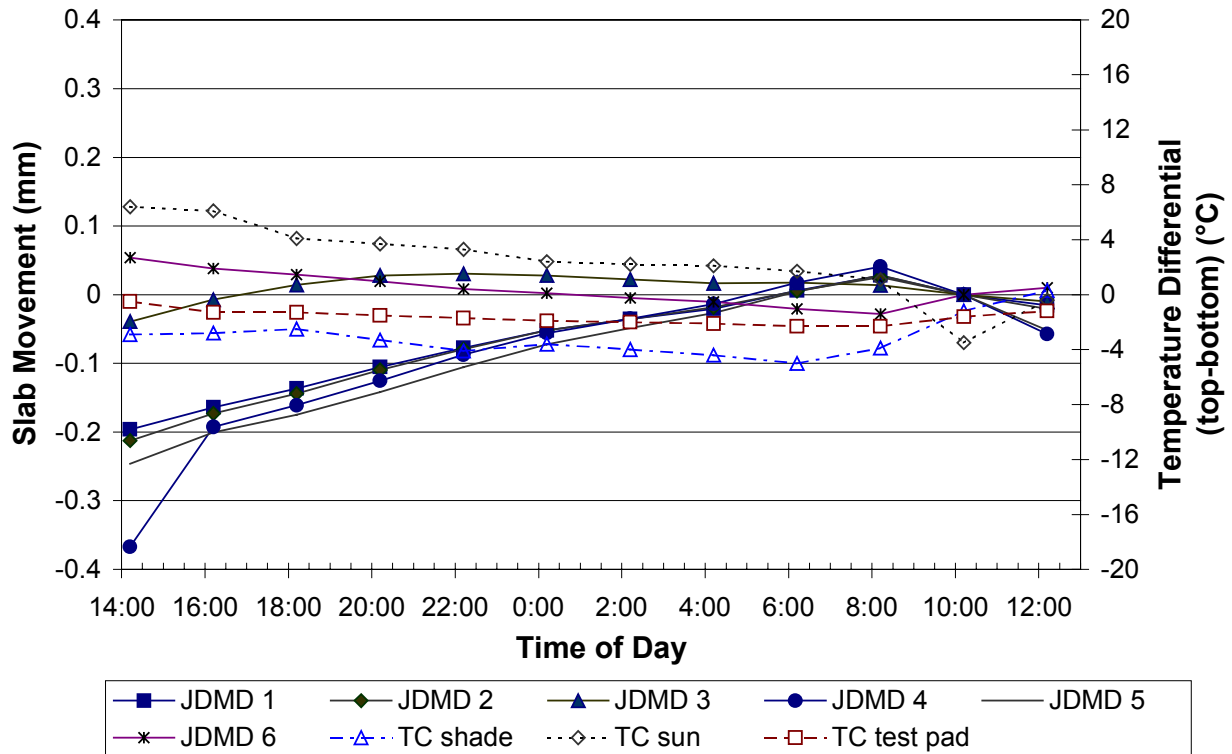

Figure 4.24. Section 536FD JDMD results (with HVS and temperature control chamber).

Table 4.15 Section 536FD Summary of all JDMD Results

	No HVS	With HVS	With HVS and temperature chamber
Total max movement (mm)			
Vertical edge & corner movement	0.571	0.175	0.408
Horizontal transverse joint movement	0.449	0.178	0.082
Maximum temperature differences) (°C)			
On the test section (top - bottom)	15.2	3.2	1.8
In the sun (top - bottom)	15.2	4.1	11.1
Day to night air temperature change	12.0	9.2	6.8

vertical movement was 2.6 mm at a maximum temperature differential of 16.3°C (see Table 4.10).

The horizontal movements were, however, not affected by the dowels and tied shoulders. The total maximum horizontal movement recorded in Test 536FD was 0.45 mm (with a maximum day-to-night surface temperature change of 18.2°C), which is similar to that recorded in Test 535FD (where the maximum horizontal movement was 0.5 mm at a maximum day-to-night surface temperature change of 18.3°C). The two sections had similar maximum surface temperatures, which would influence whether the joints locked-up (full contact) and put the slabs in compression.

4.6.2 MDD data

The MDD on 536FD is at the midpoint of the slab edge, next to the tied shoulder, as was the case on 535FD. As with the JDMD results, the effects of the tie bars, and to a lesser extent the dowels, are clearly visible on the results measured by the MDDs. Small movements were recorded throughout this series of tests. The total upward movement was on the order of 0.03 mm and downward movements were on the order of 0.21 mm. These readings were recorded despite significant temperature differentials experienced throughout the 24-hour monitoring cycle.

The MDD data are summarized in Table 4.16 and are represented graphically in Figures 4.25 to 4.27 for the three test conditions. The MDD results followed the same trend as those from the JDMDs except that smaller movements were recorded. When the HVS was parked on the section without the temperature control chamber in place, a time lag was noticed between the time at which the MDD module recorded its peak reading and the time at which the highest temperature differential was recorded (see Figure 4.26).

Table 4.16: Section 536FD Summary of MDD Results

MDD 10: Vertical movements	No HVS on site	HVS on site without temp box	HVS on site with temp box
Max upward movement			
time of day	9:28 PM	1:10 AM	4:12 AM
Outside open air temp (°C)	20.6	17	9.5
Air temp inside temp box (°C)	21.1	18	14.2
Surface temp in sun (°C)	21.2	17.4	11.6
Surface temp inside temp box (°C)	21.5	18.9	16.3
Temp difference in sun (°C)	-3.0	-3.5	-3.7
Temp difference inside temp box (°C)	-2.9	-1.4	-2.1
MDD 10: Max upward movement (mm)	0.026	0.070	0.011
Max downward movement			
time of day	11:33 AM	5:10 PM	2:12 PM
Outside open air temp (°C)	26.8	26.5	13
Air temp inside temp box (°C)	27.1	27	19.4
Surface temp in sun (°C)	34.6	30.1	21.7
Surface temp inside temp box (°C)	33.5	25.5	19.6
Temp difference in sun (°C)	11.4	9.7	4.4
Temp difference inside temp box (°C)	11.0	3.9	-0.5
MDD 10 Max downward movement (mm)	-0.206	-0.1747	-0.156
MDD 10: Maximum total movement (mm)	0.232	0.245	0.166
Total temp difference inside temp box (°C)	13.9	5.3	1.6
Total temp difference in the sun °C	14.4	13.2	8.1

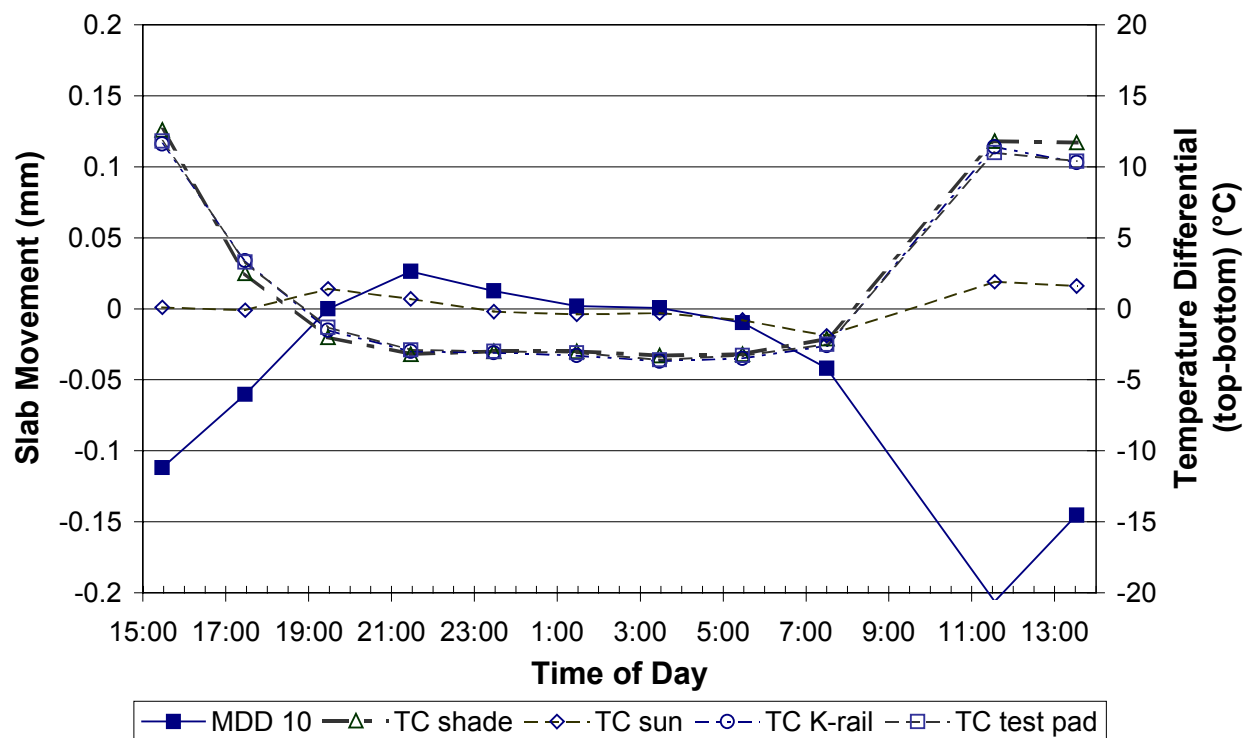

Figure 4.25. Section 536FD MDD results (no HVS, no temperature control chamber).

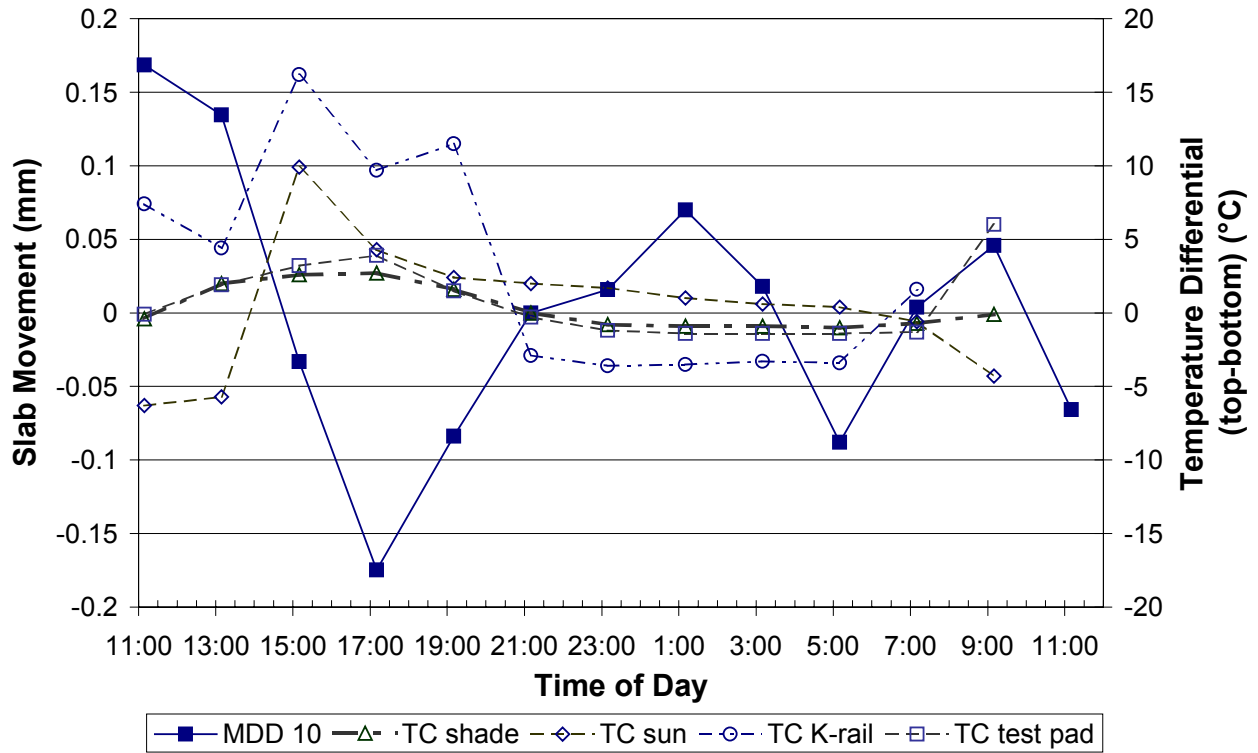

Figure 4.26. Section 536FD MDD results (with HVS, no temperature control chamber).

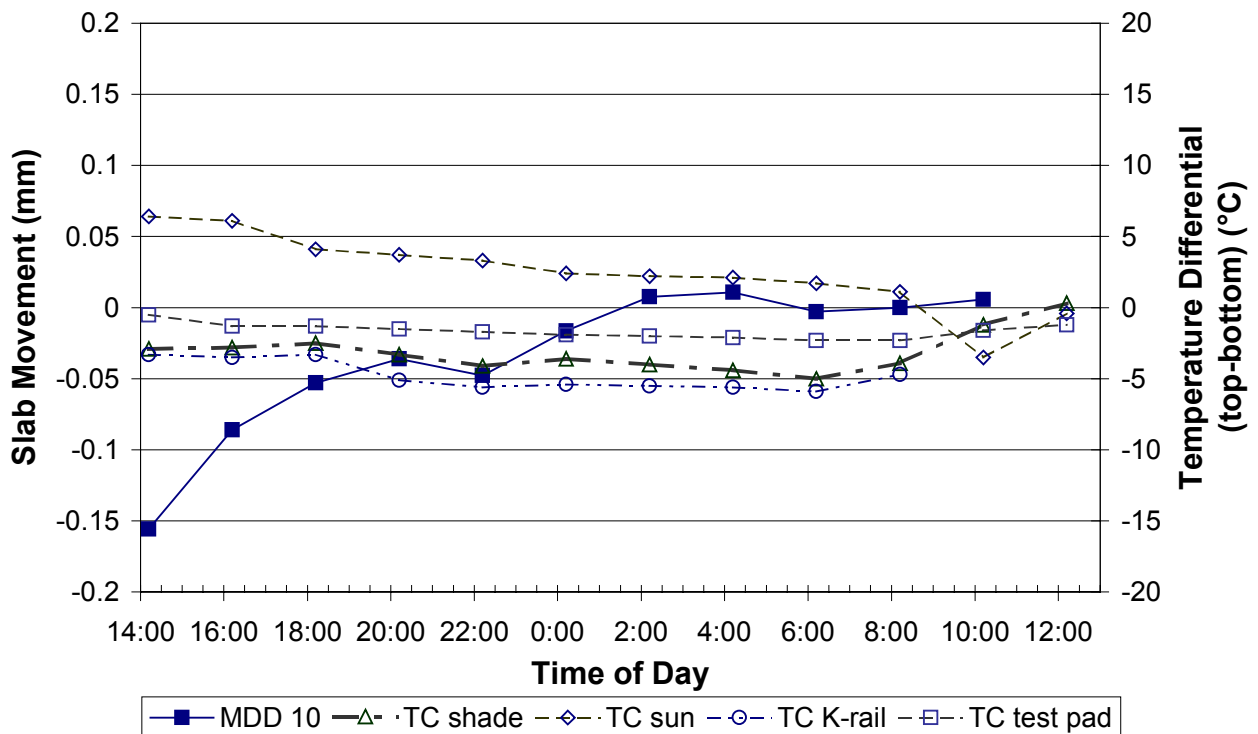

Figure 4.27. Section 536FD MDD results (with HVS and temperature control chamber).

When the HVS and the temperature control chamber were on the test section, the surface temperature inside the chamber was well controlled (total surface temperature change during the 24-hour cycle was 4.5°C). However, as with the JDMD measurements, the MDD measurements closely followed the trend of the outside temperature differentials (see Figure 4.27). Although the MDD movements during this 24-hour cycle were small (total movement = 0.166 mm), by comparison with the other two cases (0.233 mm and 0.245 mm) the effect of outside temperature changes on the exposed concrete area was noticeable inside the temperature control chamber.

A reason for this behavior may be the size of the chamber in comparison to the size of the slabs (see Figure 3.4). Good temperature control was only exercised on a portion of the whole slab and the curl of slabs outside the controlled area (fully exposed to the sun) had an effect on the responses measured inside the chamber.

4.6.3 Strain data

Several of the strain gauges were not in working order and faulty readings from these were disregarded. The results from the working instruments are summarized below.

4.6.3.1 No HVS on the test section

The maximum tensile strains were recorded between 1:30 p.m. and 3:30 p.m., depending on the different gauges (see Figure 4.28). With the exception of the Dynatest D17 gauge, the gauges went through a period of tension (3:30 p.m. – 7:30 p.m.), compression (7:30 p.m. – 7:30 a.m.) and back into tension (7:30 a.m. – 1:30 p.m.). The Dynatest D17 gauge, situated at the bottom of Slab 28, recorded the highest tensile strain (about 167 μ -strain were recorded at 3:30 p.m.) as well as the highest compression strain (132 μ -strain at 11:30 a.m.).

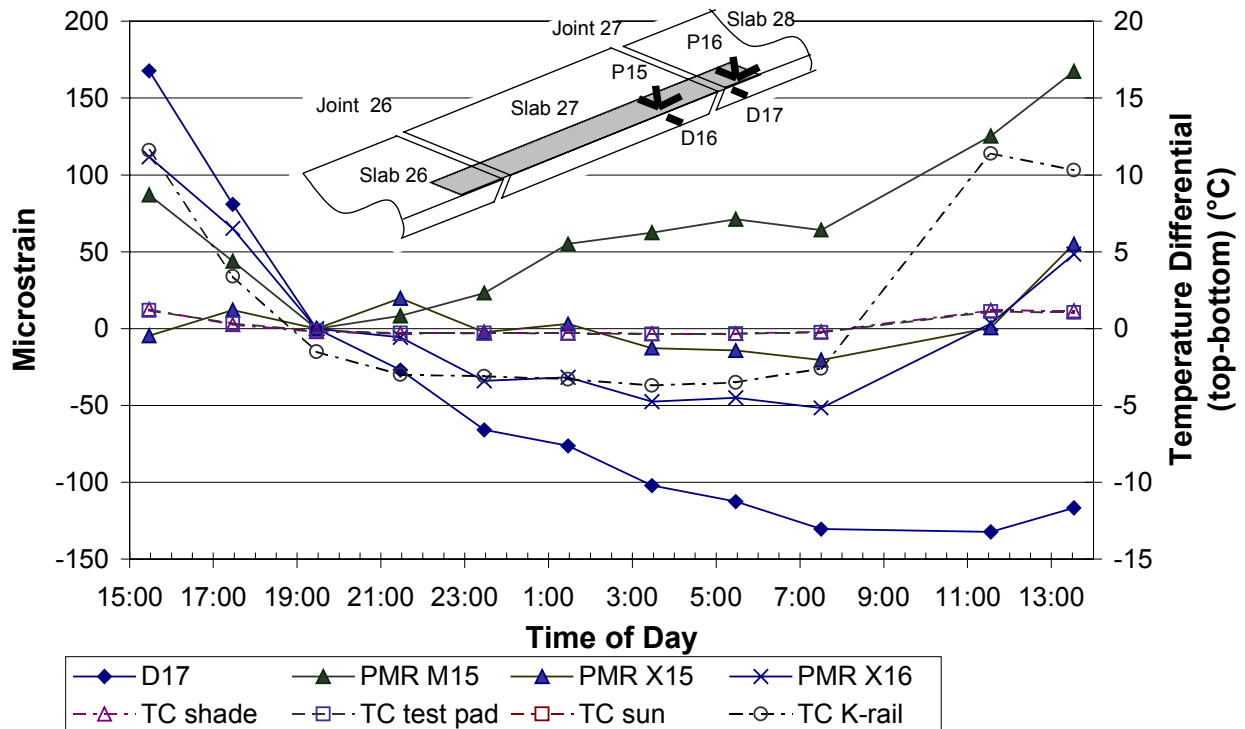

Figure 4.28. Section 536FD strain response (no HVS, no temperature control chamber).

The elastic contraction and expansion of the slab due to daily temperature variations appear to override the bending up- and downward movements caused by the temperature differentials (top – bottom) as all the gauges (top and bottom placement) experienced the same type of strain (tensile or compression) during the same 24-hour cycle. The total maximum temperature differential recorded on the test pad was only 14.3°C, whereas the total maximum day-to-night surface temperature change was 18.4°C. The results are summarized in Table 4.17.

4.6.3.2 With the HVS on the section but without the temperature control chamber

The weight of the HVS parked on the section, together with the shading had an influence on strain development. The strains recorded by the various gauges were more uniform and consistent than those with no HVS on the section (see Figure 4.29).

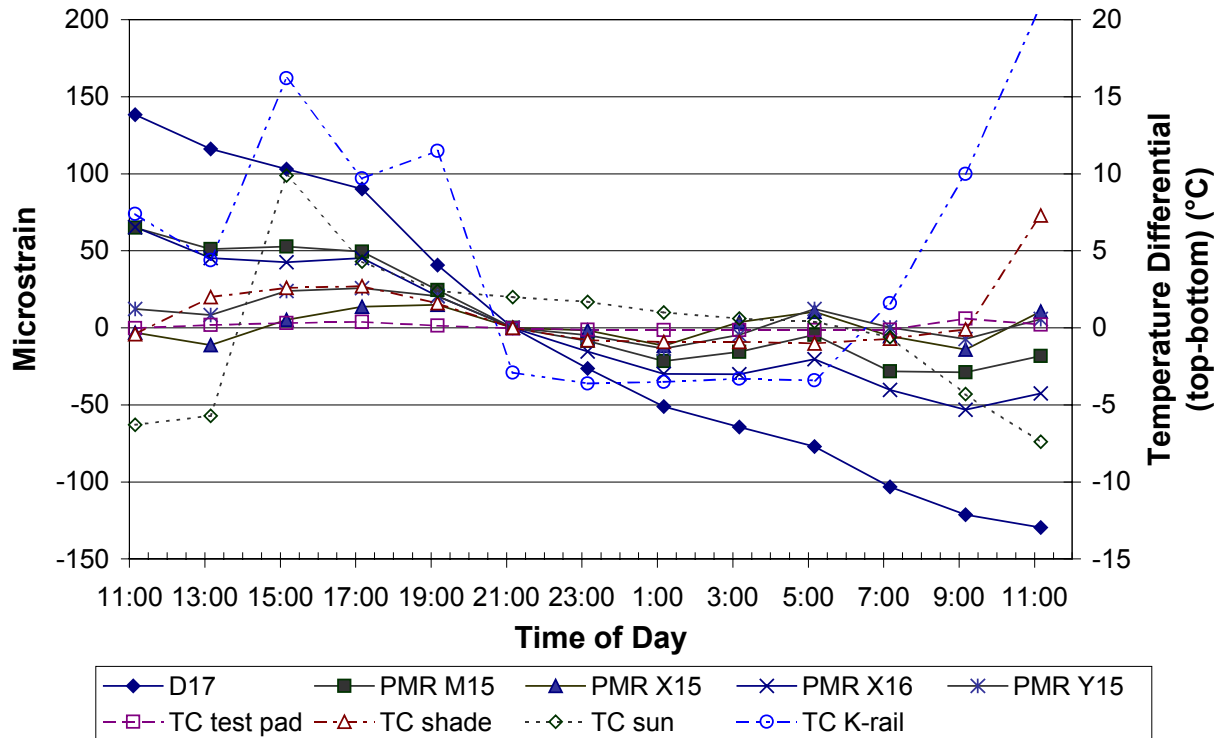

Figure 4.29. Section 536FD strain response (with HVS, no temperature control chamber).

The total temperature differential (top – bottom) under the HVS during the 24-hour period was only 4°C and that of the area completely exposed to the sun was 8.6°C. All the various gauges recorded different maximum tensile and compression strains, although they followed similar trends. Similar to the case with no HVS on the section, it seems as if the elastic contraction and expansion of the slab override the effects of slab corner curl. The total day-to-night surface temperature change on the test section was 7.4°C.

4.6.3.3 With the HVS and the temperature control chamber on the section

The data are shown in Figure 4.30. Apart from an anomalous and unexplained discontinuity at about 12:10 am, the gauges followed the same trend as without the temperature

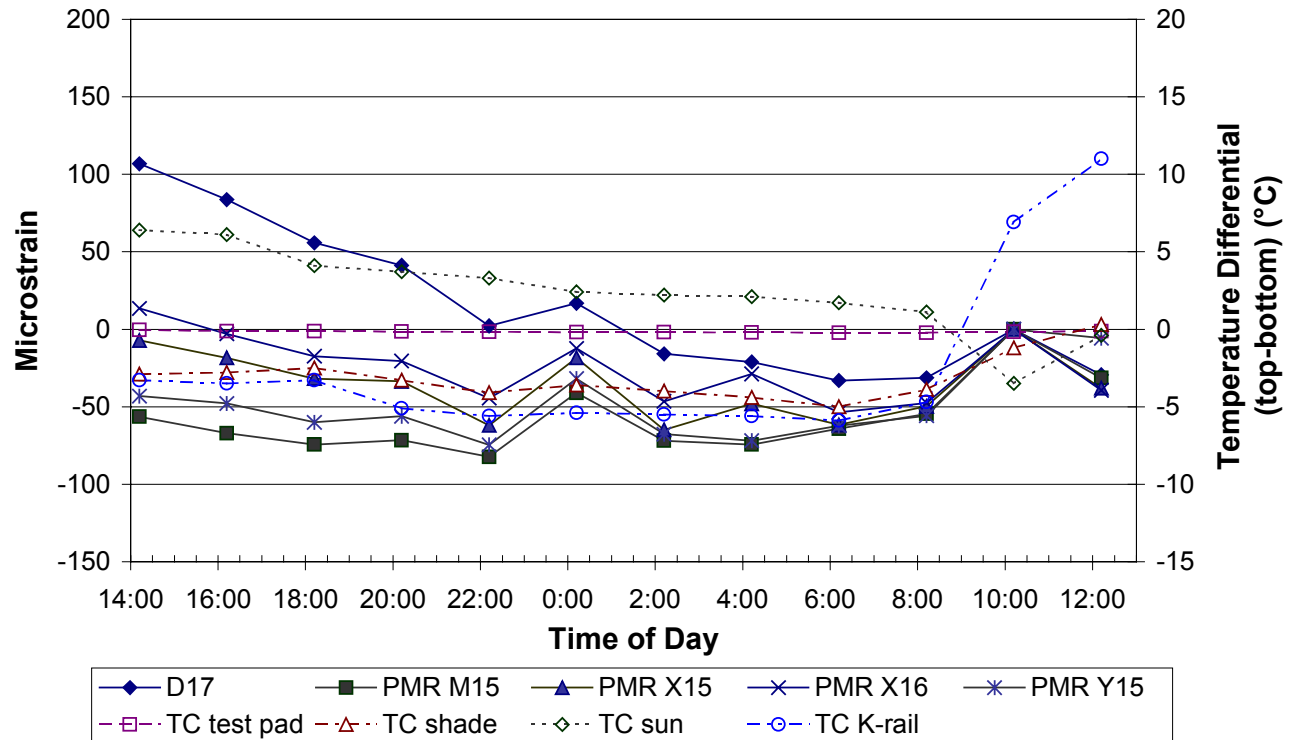

Figure 4.30. Section 536FD strain response (with HVS and temperature control chamber).

control chamber. The temperature inside the temperature control chamber was kept constant and the highest temperature differential (top – bottom) recorded during the 24hour observation cycle was -2.3°C . The outside exposed area experienced variations in the temperature differential of between $+6.4^{\circ}\text{C}$ (during the day) and -3.5° (during the night). This variation, together with the maximum total-day-to night surface temperature change (19.5°C outside and 4.5°C inside the temperature control chamber, see Table 4.14) had an influence on the strain state of the various gauges, as can be seen in Figure 4.30.

Except for Gauge D17, the behavior of the gauges was fairly uniform and the results of all the gauges followed similar trends. In general, the total strain variation was lower than that in the case where the section was completely (no HVS, no temperature control chamber). The data is summarized in Table 4.17.

Table 4.17 Section 536FD Summary of Strain Gauge Results

Strain results	No HVS on site	HVS on site without temp box	HVS on site with temp box
Maximum Compression strains recorded			
Time of day	7:30 AM	9:10 AM	10:00 PM - 6:00 AM
Outside open air temp (° C)	20.6	21.1	10
Air temp inside temp box (° C)	19.7	20.7	14.6
Surface temp inside temp box (° C)	17.9	25.8	16.8
Temp difference in the sun (° C)	-2.6	-4.3	-3.5
Temp difference inside temp box (° C)	-2.5	-1.3	-2.3
<u>Strain results (microstrain):</u>			
Dynatest D17	-132.1884	-129.6198	-33.1048
PMR M15	NA	-28.9307	-82.3388
PMR X15	-20.4074	-14.1415	-64.9178
PMR X16	-51.6418	-53.2297	-53.5172
PMR Y15	NA	-7.2205	-74.6248
Maximum Tensile strains recorded			
Time of day	1:30 - 3:30 PM	11:09 AM	2:12 PM
Outside open air temp (Deg C)	26.4 - 30.9	19.1	13
Air temp inside temp box (deg C)	32.3 - 38.1	18.6	19.4
Surface temp inside temp box (deg C)	34.6 - 36.0	18.4	19.6
Temp difference in the sun (° C)	12.6	4.3	6.4
Temp difference inside temp box (° C)	11.8	2.7	-0.5
<u>Strain results (microstrain):</u>			
Dynatest D17	167.6968	138.2943	106.834
PMR M15	167.3548	65.1492	0
PMR X15	55.0226	15.072	0
PMR X16	111.7322	65.4332	13.3656
PMR Y15	NA	25.6804	0
Total strain variation throughout 24hour cycle			
Dynatest D17	299.8852	267.9141	139.9388
PMR M15	NA	94.0799	82.3388
PMR X15	75.43	29.2135	64.9178
PMR X16	163.374	118.6629	66.8828
PMR Y15	NA	32.9009	74.6248
Max total temp diff on test pad (°C)	14.3	4	1.8
Max total temp diff recorded in the sun (°C)	15.2	8.6	9.9
Max total 24h day to night temperature changes			
Air temp change: outside temp box (°C)	12	9.5	9
Air temp change: inside temp box (°C)	12	9.2	6.8
Surface temp change: outside temp box (°C)	18.2	21	19.5
Surface temp change: inside temp box (°C)	18.4	7.4	4.5

As in the case of the measurements recorded by the JDMDs and the MDDs, the strains recorded by the various gauges closely followed the trend of the outside temperature differentials (see Figure 4.30). Although there was tight temperature control inside the temperature control chamber, the curling, contraction, and expansion of the concrete slab as a result of temperature changes was influenced by the behavior of the exposed part of the slabs outside the chamber.

4.7 Test 537FD

Test 537FD was the second test conducted on the section with dowels and a tied shoulder (see Section 3.0) and was performed on Slabs 22, 23, and 24. The slab lengths are very similar to those of Test 536FD (see Table 3.2).

4.7.1 JDMD Data

The results of all three cases (without the HVS; with the HVS; and with the HVS and with the temperature control chamber in place) are summarized in Tables 4.18 to 4.20. The total JDMD movements over the 24-hour cycle can be seen in Figures 4.31 to 4.33. The results from all three cases are summarized in Table 4.21.

The maximum total vertical movement (no HVS on test section) recorded was 1.81 mm with JDMD 1 on the edge of Slab 24, Joint 23. This was caused by a maximum temperature differential of 16.2°C. The maximum horizontal movement was 0.66 mm (Joint 23) while the maximum day-to-night surface temperature change was 12.6°C.

These movements are higher than those recorded during the previous test (536FD) with the same structure. One reason for this is the higher temperature differentials recorded during 537FD. The surface temperature at maximum downward movement of the slab was 34.6 °C for Test 536FD but was 40.2°C for Section 537FD.

Table 4.18: Section 537FD Summary of JDMD Results (no HVS, no Temperature Control Chamber)

		Critical Case	all JDMD data				
			1	2	3	4	5
JDMD 1 to 5: Vertical edge and corner movements							
Max downward Movement							
time of day	2:30 PM						
Outside air temp (°C)	35.4						
Surface temp (°C)	40.2						
Temp difference at time of max movement (°C)	12.1						
Max downward Movement (mm)	-0.563	-0.563	-0.448	-0.436	-0.199	-0.202	
position	JDMD-1						
Max upward Movement							
time of day	6:30 AM						
Outside air temp (°C)	23.5						
Surface temp (°C)	23.0						
Temp difference (°C)	-4.1						
Max upward Movement (mm)	1.249	1.249	1.114	0.353	0.452	0.419	
position	JDMD-1						
Maximum total movement (mm)	1.8118	1.812	1.562	0.789	0.651	0.621	
Total temp difference (top - bottom) (°C)	16.2						
Horizontal slab edge movement JDMD 6							
time of day	4:30 PM						
Outside air temp (°C)	32.9						
Surface temp (°C)	38.7						
Temp difference (°C)	9.0						
Max Closing Movement (mm)	0.103						
time of day	6:30 AM						
Outside air temp (°C)	23.5						
Surface temp (°C)	23.0						
Temp difference (°C)	-4.1						
Max opening Movement (mm)	-0.560						
Max total joint horizontal movement (mm)	0.663						
Total temp difference (top-bottom) (°C)	13.1						
Max total 24h day to night temperature changes							
Air temp change: outside temp box (°C)	10.1						
Air temp change: inside temp box (°C)	12.6						
Surface temp change: outside temp box (°C)	16.9						
Surface temp change: inside temp box (°C)	17.2						

Table 4.19: Section 537FD Summary of JDMD Results (with HVS, without Temperature Control Chamber)

		Critical Case	all JDMD data				
			1	2	3	4	5
JDMD 1 to 5: Vertical edge and corner movements							
Max downward Movement							
time of day	12:35 PM						
Outside open air temp (°C)	33.5						
Air temp: under the HVS (°C)	34.0						
Surface temp away fom HVS (°C)	41.9						
Surface temp under HVS (°C)	32.6						
Temp difference (°C) away from HVS	17.5						
Temp difference (°C) under HVS	3.6						
Max downward Movement (mm)	-0.433	-0.433	-0.429	-0.432	-0.208	-0.157	
position	JDMD-1						
Max upward movement							
time of day	6:35 AM						
Outside air temp in open air	22.9						
Air temp: under the HVS	23.3						
Surface temp away fom HVS	24.5						
Surface temp under HVS	25.2						
Temp difference (°C) away from HVS	-3.3						
Temp difference (°C) under HVS	-2.1						
Max upward Movement (mm)	0.476	0.476	0.427	0.113	0.238	0.223	
position	JDMD-1						
Max total movement (mm)	0.909	0.909	0.856	0.545	0.445	0.380	
Total temp difference (top - bottom) under HVS (°C)	5.7						
Horizontal slab edge movement							
time of day	4:35 PM						
Outside air temp in open air (°C)	33.3						
Air temp: under the HVS (°C)	32.4						
Surface temp away fom HVS (°C)	40.9						
Surface temp under HVS (°C)	31.6						
Temp difference (°C) away from HVS	9.1						
Temp difference (°C) under HVS	3.1						
Max Closing Movement (mm)	0.093						
time of day	8:35 AM						
Outside air temp in open air (°C)	24.6						
Air temp: under the HVS (°C)	24.2						
Surface temp away fom HVS (°C)	25.5						
Surface temp under HVS (°C)	26.0						
Temp difference (°C) away from HVS	-2.1						
Temp difference (°C) under HVS	-0.9						
Max opening Movement (mm)	-0.257						
Max total joint horizontal movement (mm)	0.351						
Total temp difference (top - bottom) under HVS (°C)	4.0						
Max total 24h day to night temperature changes							
Air temp change: outside temp box (°C)	11.3						
Air temp change: inside temp box (°C)	11.1						
Surface temp change: outside temp box (°C)	19.0						
Surface temp change: inside temp box (°C)	7.4						

Table 4.20: Section 537FD Summary of JDMD Results (with HVS and Temperature Control Chamber)

		Critical Case	all JDMD data				
			1	2	3	4	5
JDMD 1 to 5: Vertical edge and corner movements							
Max downward Movement							
time of day	2:57 PM						
Outside open air temp (°C)	33.5						
Air temp: under the HVS (°C)	22.8						
Surface temp away fom HVS (°C)	43.2						
Surface temp under HVS (°C)	23.0						
Temp difference (°C) away from HVS	12.5						
Temp difference (°C) under HVS	-2.2						
Max downward Movement (mm)	-0.163	-0.163	-0.159	-0.117	-0.038	-0.042	
position	JDMD-1						

Max upward movement						
time of day	2:57 AM					
Outside air temp in open air	25.2					
Air temp: under the HVS	21.4					
Surface temp away fom HVS	25.3					
Surface temp under HVS	22.7					
Temp difference (°C) away from HVS	-4.6					
Temp difference (°C) under HVS	-1.9					
Max upward Movement (mm)	0.157	0.157	0.152	0.076	0.038	0.037
position	JDMD-1					
Max total movement (mm)	0.320	0.320	0.311	0.193	0.076	0.079
Total temp difference (top - bottom) under HVS (°C)	-0.3					

Horizontal slab edge movement	
time of day	4:57 PM
Outside air temp in open air (°C)	31.7
Air temp: under the HVS (°C)	22.9
Surface temp away fom HVS (°C)	41.1
Surface temp under HVS (°C)	23.6
Temp difference (°C) away from HVS	8.4
Temp difference (°C) under HVS	-1.9
Max Closing Movement (mm)	0.012
time of day	6:57 AM
Outside air temp in open air (°C)	24.9
Air temp: under the HVS (°C)	20.8
Surface temp away fom HVS (°C)	23.6
Surface temp under HVS (°C)	22.3
Temp difference (°C) away from HVS	-4.6
Temp difference (°C) under HVS	-1.8
Max opening Movement (mm)	-0.061
Max total joint horizontal movement (mm)	0.073
Total temp difference (top - bottom) under HVS (°C)	-0.1

Max total 24h day to night temperature changes	
Air temp change: outside temp box (°C)	9.6
Air temp change: inside temp box (°C)	2.4
Surface temp change: outside temp box (°C)	19.6
Surface temp change: inside temp box (°C)	1.7

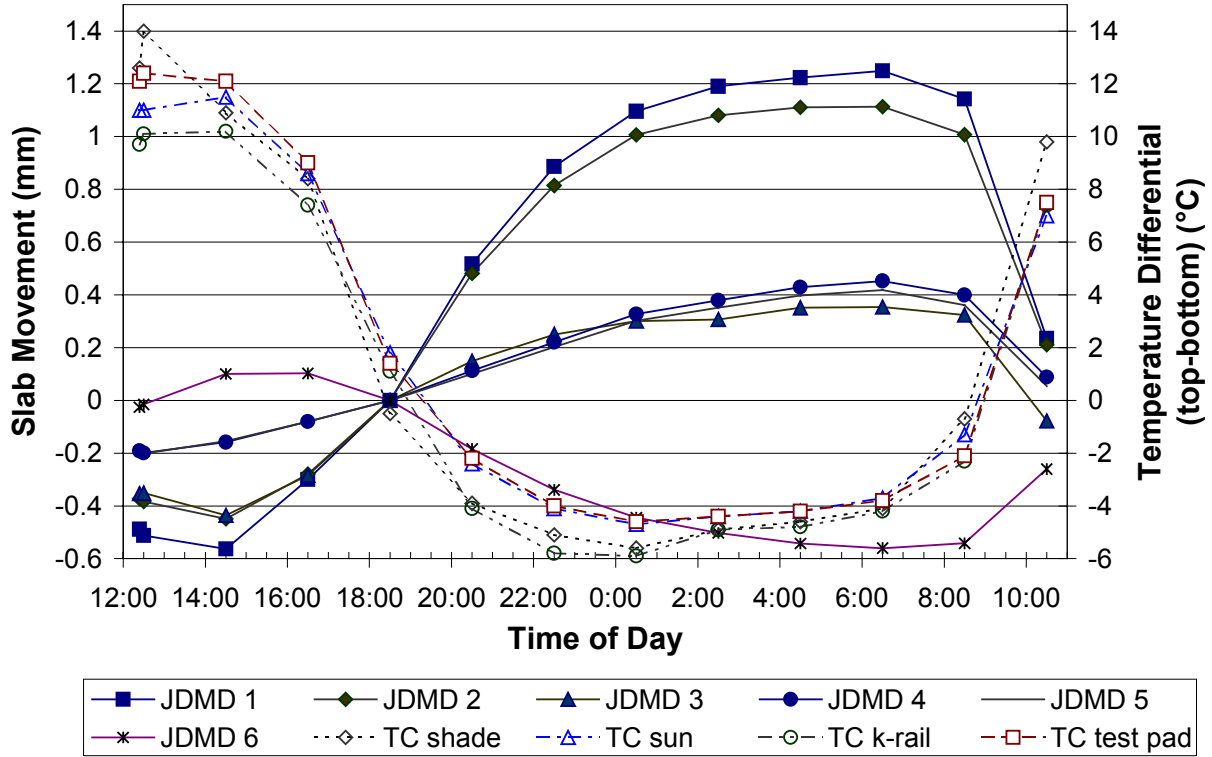

Figure 4.31. Section 537FD JDMD results (no HVS, no temperature control chamber).

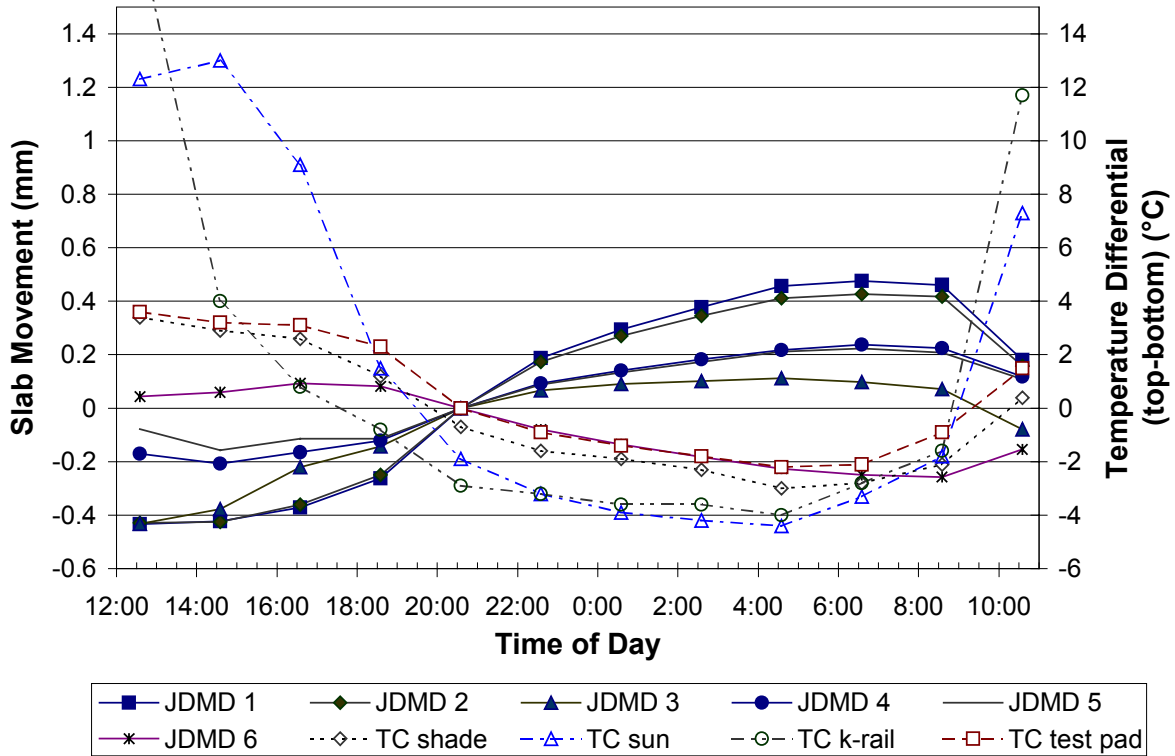

Figure 4.32. Section 537FD JDMD results (with HVS, no temperature control chamber).

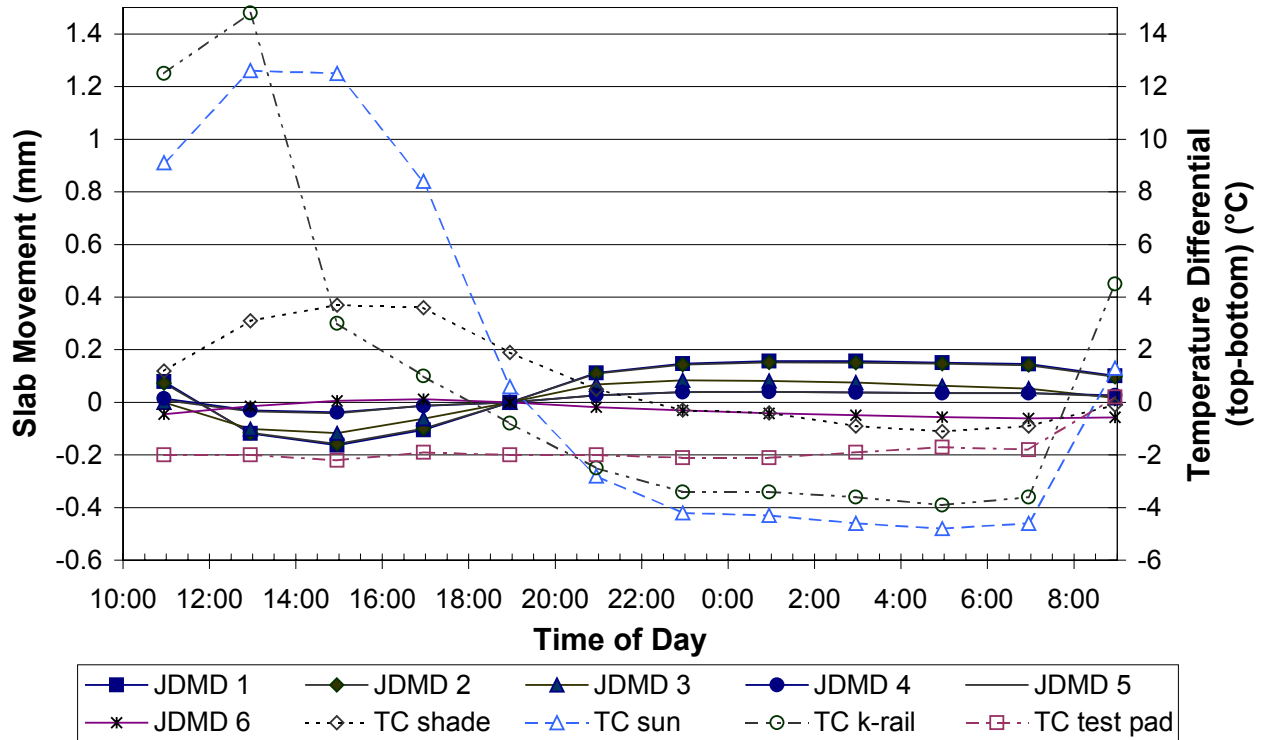

Figure 4.33. Section 537FD JDMD results (with HVS and temperature control chamber).

Table 4.21 Section 537FD Summary of JDMD Results

	No HVS	With HVS	With HVS and temperature chamber
Total max movement (mm)			
Vertical edge & corner movement	1.812	0.909	0.320
Horizontal transverse joint movement	0.663	0.351	0.073
Maximum temperature differences) (°C)			
On the test section (top - bottom)	16.2	5.7	-0.3
In the sun (top - bottom)	16.2	20.8	17.1
Day to night air temperature change	12.6	11.1	2.4

The same trend is observed for the case where the HVS is parked on the section.

For the case of the temperature control chamber in operation, the results of the two tests (536FD and 537FD) are very similar. Maximum vertical movement for Test 537FD was 0.32 mm (maximum temperature differential = -0.3) compared to 0.408 mm (maximum temperature differential = -1.8) for Test 536FD. The same is observed for the horizontal movements.

A summary of all the movements of all three cases can be found in Table 4.21. The effect of the shading and temperature control is obvious in both the vertical as well as the horizontal slab edge movements.

4.7.2 MDD Data

The MDDs on Test 537FD were located near the slab corners. As with the JDMD data, the effect of the dowels and tie bars are visible in the MDD data. Small movements were recorded with both MDD 9 (Slab 24) and MDD 8 (Slab 23) in comparison with the JDMD results. A maximum movement of 0.511 mm was recorded by MDD 8 when the whole test section was completely exposed to the sun. The summary results are presented in Table 4.22 and are graphically displayed in Figures 4.34 to 4.36 for the three cases.

The influence of the temperature control chamber is clearly visible as presented in Figure 4.36. Although some movement was recorded, the MDD responses were small as were the temperature differentials.

Table 4.22 Section 537FD Summary of MDD Results

MDD 8 & 9: Vertical movements	No HVS on site	HVS on site without temp box	HVS on site with temp box
Max upward movement			
time of day	6:30 AM	8:35 AM	4:57 AM
Outside open air temp (°C)	23.4	24.6	23.9
Air temp inside temp box (°C)	23.5	24.2	21.3
Surface temp in sun (°C)	23.3	25.5	24.1
Surface temp inside temp box (°C)	23	26	22.6
Temp difference in sun (°C)	-3.7	-1.8	-4.8
Temp difference inside temp box (°C)	-3.8	-0.9	-1.7
MDD 9: Max upward movement (mm)	0.374	0.148	0.049
MDD 8: Max upward movement (mm)	0.4193	0.159	0.0508
Max downward movement			
time of day	2:30 PM	2:35 PM	2:57 PM
Outside open air temp (°C)	31.5	33.2	33.5
Air temp inside temp box (°C)	35.4	33.6	22.8
Surface temp in sun (°C)	40.2	43.1	43.2
Surface temp inside temp box (°C)	40.2	31.5	23
Temp difference in sun (°C)	11.5	13	12.5
Temp difference inside temp box (°C)	12.1	3.2	-2.2
MDD 9: Max downward movement (mm)	-0.095	-0.095	-0.0363
MDD 8: Max downward movement (mm)	-0.091	-0.097	-0.0305
MDD 9: Maximum total movement (mm)	0.469	0.243	0.085
MDD 8: Maximum total movement (mm)	0.511	0.256	0.081
Total temp difference inside temp box (°C)	15.9	4.1	-0.5
Total temp difference in the sun °C	15.2	14.8	17.3

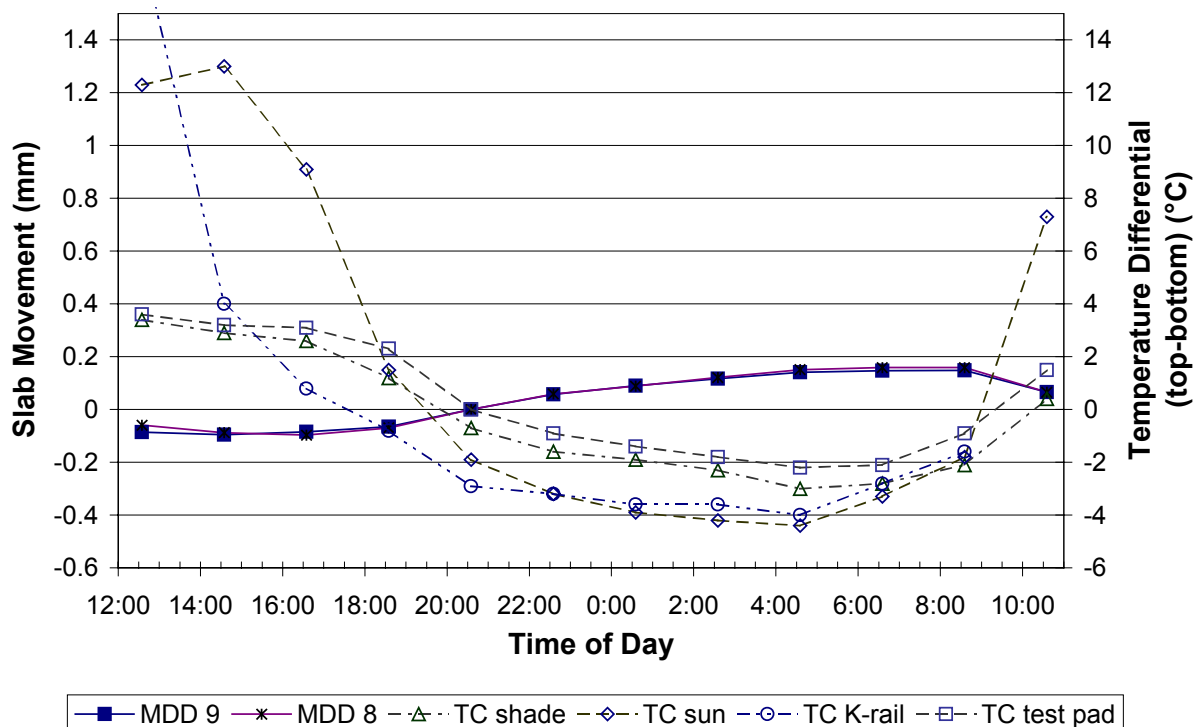

Figure 4.34. Section 537FD MDD results (no HVS, no temperature control chamber).

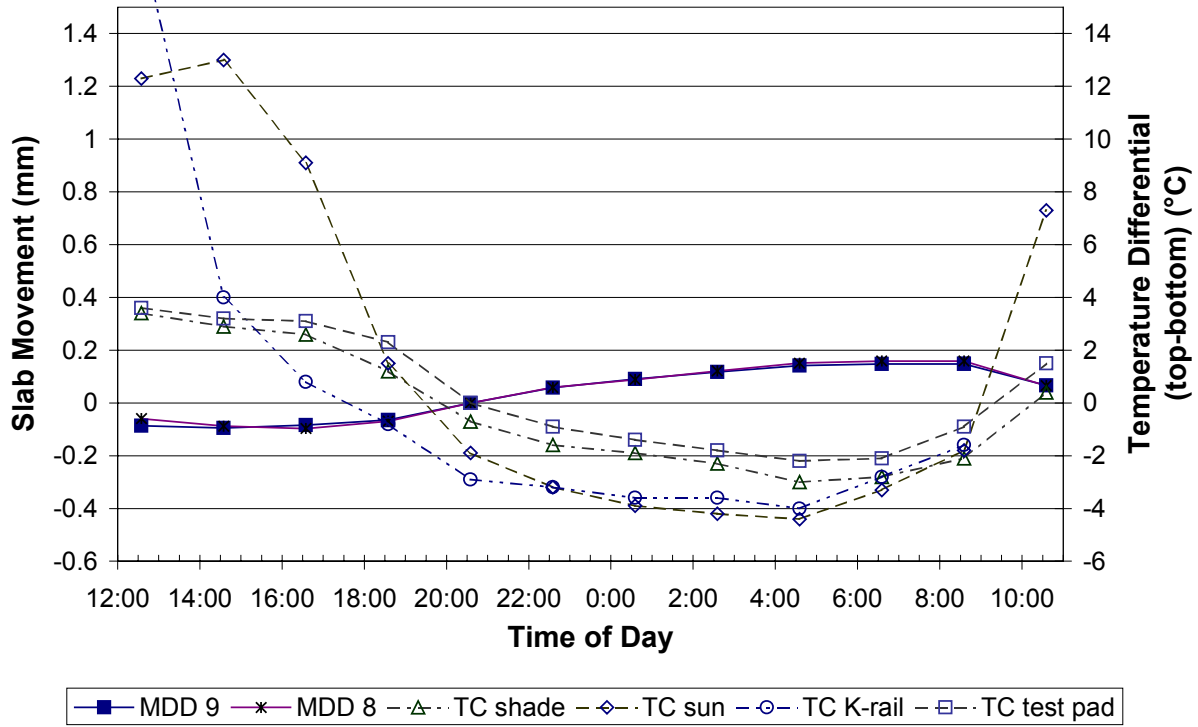

Figure 4.35. Section 537FD MDD results (with HVS, no temperature control chamber).

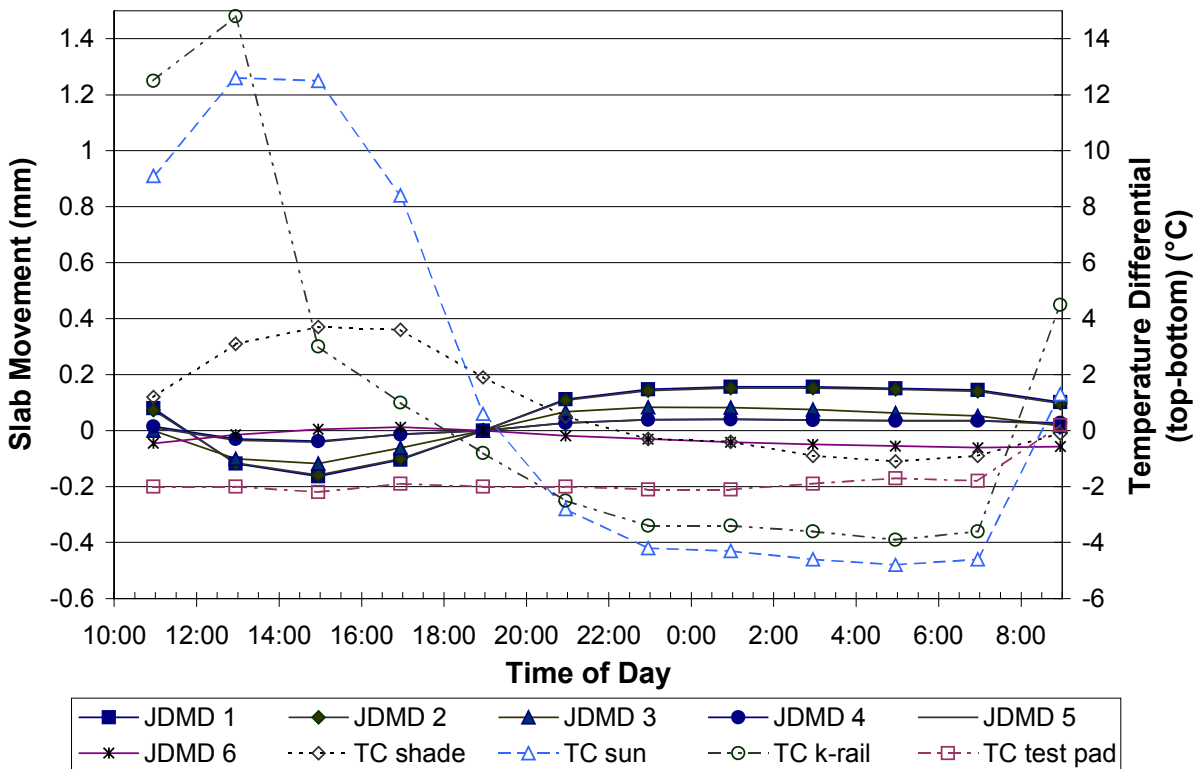

Figure 4.36. Section 537FD MDD results (with HVS and temperature control chamber).

4.8 Test 538FD

Test 538FD was the last of the series of tests conducted on concrete slabs with dowels and a tied shoulder. The test was conducted on Slabs 18, 19, and 20 on Section 9. The results from the various instruments are discussed in the following sections.

Test 538FD was the last test conducted at the Palmdale Northbound side and was begun on 29 December after all other tests had been completed (up to Test 541FD) (see Table 3.1). Neither strain gauges nor MDDs were installed at this section. Only JDMDs were used to collect the data. The test was performed without the use of the temperature control chamber.

4.8.1 JDMD Data

The results of both cases (without the HVS, and with the HVS but without the temperature control chamber) are summarized in Tables 4.23 and 4.24. The total JDMD movements over the 24-hour cycle can be seen in Figures 4.40 and 4.41. The results of both cases are summarized in Table 4.25

A maximum vertical movement of 0.982 mm was recorded with JDMD 4, situated at Joint 18 on Slab 19. This movement was under the influence of an 11.5°C temperature differential. The maximum horizontal movement was 0.320 mm, which was recorded at Joint 19 (between Slabs 19 and 20). The total day-to-night surface temperature change was 11.1°C.

The effect of the shade created by the HVS is clear in both the vertical as well as the horizontal slab edge movements (Table 4.25).

Table 4.23: Section 538FD Summary of JDMD Results (no HVS, no Temperature Control Chamber)

		Critical Case	all JDMD data				
			1	2	3	4	5
JDMD 1 to 5: Vertical edge and corner movements							
Max downward Movement							
time of day	1:06 PM						
Outside air temp (°C)	17.5						
Surface temp (°C)	19.6						
Temp difference at time of max movement (°C)	8.4						
Max downward Movement (mm)	-0.506	-0.438	-0.403	-0.092	-0.506	-0.454	
position	JDMD-4						
Max upward Movement							
time of day	7:06 AM						
Outside air temp (°C)	9.7						
Surface temp (°C)	7.6						
Temp difference (°C)	-3.1						
Max upward Movement (mm)	0.5181	0.393	0.368	0.098	0.476	0.518	
position	JDMD-5						
Maximum total movement (mm)	0.982	0.831	0.771	0.190	0.982	0.972	
Total temp difference (top - bottom) (°C)	11.5						
Horizontal slab edge movement JDMD 6							
time of day	1:06 PM						
Outside air temp (°C)	17.5						
Surface temp (°C)	19.6						
Temp difference (°C)	8.4						
Max Closing Movement (mm)	0.171						
time of day	7:06 AM						
Outside air temp (°C)	9.7						
Surface temp (°C)	7.6						
Temp difference (°C)	-3.1						
Max opening Movement (mm)	-0.149						
Max total joint horizontal movement (mm)	0.320						
Total temp difference (top-bottom) (°C)	11.5						
Max total 24h day to night temperature changes							
Air temp change: outside temp box (°C)	10.6						
Air temp change: inside temp box (°C)	10.6						
Surface temp change: outside temp box (°C)	11.1						
Surface temp change: inside temp box (°C)	12.0						

Table 4.24 Section 538FD Summary of JDMD Results (with HVS, without Temperature Control Chamber)

		Critical Case	all JDMD data				
			1	2	3	4	5
JDMD 1 to 5: Vertical edge and corner movements							
Max downward Movement							
time of day	1:04 PM						
Outside open air temp (°C)	19.8						
Air temp: under the HVS (°C)	20.0						
Surface temp away fom HVS (°C)	22.5						
Surface temp under HVS (°C)	23.0						
Temp difference (°C) away from HVS	4.3						
Temp difference (°C) under HVS	10.6						
Max downward Movement (mm)	-0.417	-0.417	-0.379	-0.025	-0.204	-0.193	
position	JDMD-1						

Max upward movement							
time of day	7:05 AM						
Outside air temp in open air	13.2						
Air temp: under the HVS	12.8						
Surface temp away fom HVS	11.1						
Surface temp under HVS	13.2						
Temp difference (°C) away from HVS	-1.7						
Temp difference (°C) under HVS	-0.8						
Max upward Movement (mm)	0.232	0.232	0.192	0.024	0.094	0.068	
position	JDMD-1						
Max total movement (mm)	0.649	0.649	0.571	0.049	0.298	0.261	
Total temp difference (top - bottom) under HVS (°C)	11.4						

Horizontal slab edge movement							
time of day	1:04 PM						
Outside air temp in open air (°C)	19.8						
Air temp: under the HVS (°C)	20.0						
Surface temp away fom HVS (°C)	22.5						
Surface temp under HVS (°C)	23.0						
Temp difference (°C) away from HVS	4.3						
Temp difference (°C) under HVS	10.6						
Max Closing Movement (mm)	0.103						
time of day	7:05 AM						
Outside air temp in open air (°C)	13.2						
Air temp: under the HVS (°C)	12.8						
Surface temp away fom HVS (°C)	11.1						
Surface temp under HVS (°C)	13.2						
Temp difference (°C) away from HVS	-1.7						
Temp difference (°C) under HVS	-0.8						
Max opening Movement (mm)	-0.067						
Max total joint horizontal movement (mm)	0.171						
Total temp difference (top - bottom) under HVS (°C)	11.4						

Max total 24h day to night temperature changes	
Air temp change: outside temp box (°C)	8.5
Air temp change: inside temp box (°C)	7.4
Surface temp change: outside temp box (°C)	11.4
Surface temp change: inside temp box (°C)	9.8

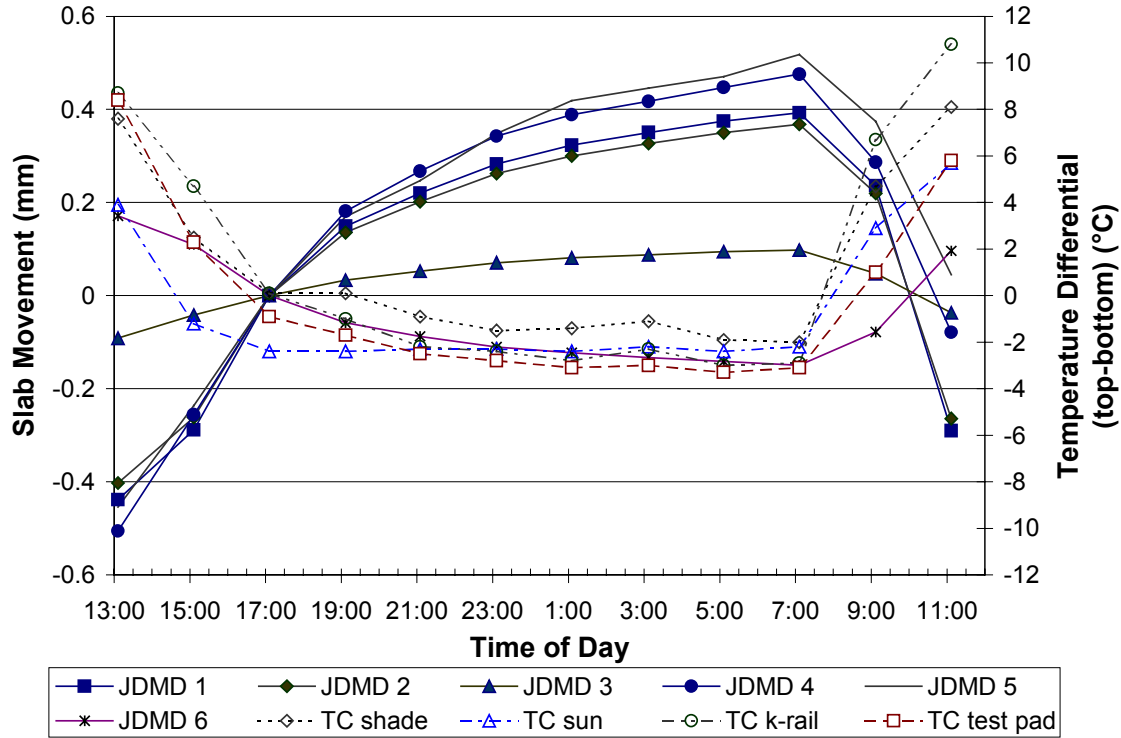

Figure 4.37. Section 538FD JDMD data (no HVS, no temperature control chamber).

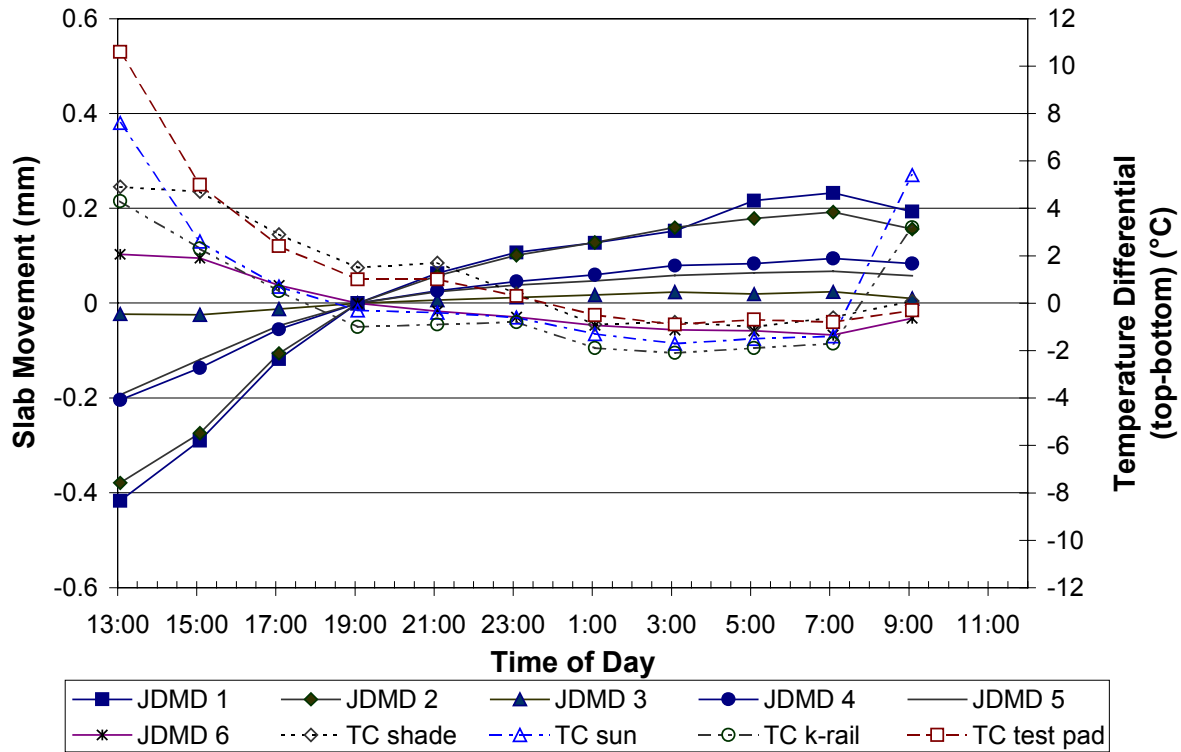

Figure 4.38. Section 538FD JDMD data (with HVS, no temperature control chamber).

Table 4.25 Section 538FD Summary of JDMD Results

	No HVS	With HVS
Total max movement (mm)		
Vertical edge & corner movement	0.982	0.649
Horizontal transverse joint movement	0.320	0.171
Maximum temperature differences) (°C)		
On the test section (top - bottom)	11.5	11.4
In the sun (top - bottom)	11.5	6.0
Day to night air temperature change	10.6	7.4

4.9 Test 539FD

Test 539FD was the first of three tests conducted on concrete slabs with dowels, an asphalt shoulder, and increased lane width (4.3 m instead of the standard 3.7 m) (see Section 3.0). Test 539FD was performed on Slabs 10, 11, and 12 of the North Tangent. The following sections detail the test results.

4.9.1 JDMD data

The results of all three cases (without the HVS; with the HVS but without the temperature control chamber; with the HVS and with the temperature control chamber in place) are summarized in Tables 4.26 to 4.28. The total JDMD movements over the 24-hour cycle can be seen in Figures 4.42 to 4.44.

A summary of all three cases can be found in Table 4.29. The effect of the shading and temperature control is obvious in both the vertical as well as the horizontal slab edge movements.

Table 4.26: Section 539FD Summary of JDMD Results (no HVS, no Temperature Control Chamber)

		Critical Case	all JDMD data				
			1	2	3	4	5
JDMD 1 to 5: Vertical edge and corner movements							
Max downward Movement							
time of day	4:32 PM						
Outside air temp (°C)	34.6						
Surface temp (°C)	37.2						
Temp difference at time of max movement (°C)	12.7						
Max downward Movement (mm)	-0.710	-0.681	-0.676	-0.643	-0.710	-0.662	
position	JDMD-4						

Max upward Movement						
time of day	6:32 AM					
Outside air temp (°C)	23.6					
Surface temp (°C)	24.1					
Temp difference (°C)	-4.8					
Max upward Movement (mm)	2.263	2.263	2.219	1.596	2.199	2.100
position	JDMD-1					
Maximum total movement (mm)	2.972	2.943	2.894	2.239	2.908	2.762
Total temp difference (top - bottom) (°C)	17.5					

Horizontal slab edge movement JDMD 6	
time of day	4:32 PM
Outside air temp (°C)	34.6
Surface temp (°C)	37.2
Temp difference (°C)	12.7
Max Closing Movement (mm)	0.097
time of day	6:32 AM
Outside air temp (°C)	23.6
Surface temp (°C)	24.1
Temp difference (°C)	-4.8
Max opening Movement (mm)	-0.553
Max total joint horizontal movement (mm)	0.650
Total temp difference (top-bottom) (°C)	17.5

Max total 24h day to night temperature changes	
Air temp change: outside temp box (°C)	12.0
Air temp change: inside temp box (°C)	12.7
Surface temp change: outside temp box (°C)	17.2
Surface temp change: inside temp box (°C)	18.3

Table 4.27 Section 539FD Summary of JDMD Results (with HVS, without Temperature Control Chamber)

		Critical Case	all JDMD data				
			1	2	3	4	5
JDMD 1 to 5: Vertical edge and corner movements							
Max downward Movement							
time of day	12:35 PM						
Outside open air temp (°C)	33.5						
Air temp: under the HVS (°C)	34.0						
Surface temp away fom HVS (°C)	41.9						
Surface temp under HVS (°C)	32.6						
Temp difference (°C) away from HVS	12.3						
Temp difference (°C) under HVS	3.6						
Max downward Movement (mm)	-0.433	-0.433	-0.429	-0.432	-0.208	-0.157	
position	JDMD-1						
Max upward movement							
time of day	6:35 AM						
Outside air temp in open air	22.9						
Air temp: under the HVS	23.3						
Surface temp away fom HVS	24.5						
Surface temp under HVS	25.2						
Temp difference (°C) away from HVS	-3.3						
Temp difference (°C) under HVS	-2.1						
Max upward Movement (mm)	0.476	0.476	0.427	0.113	0.238	0.223	
position	JDMD-1						
Max total movement (mm)	0.909	0.909	0.856	0.545	0.445	0.380	
Total temp difference (top - bottom) under HVS (°C)	5.7						
Horizontal slab edge movement							
time of day	4:35 PM						
Outside air temp in open air (°C)	33.3						
Air temp: under the HVS (°C)	32.4						
Surface temp away fom HVS (°C)	40.9						
Surface temp under HVS (°C)	31.6						
Temp difference (°C) away from HVS	12.3						
Temp difference (°C) under HVS	3.6						
Max Closing Movement (mm)	0.093						
time of day	8:35 AM						
Outside air temp in open air (°C)	24.6						
Air temp: under the HVS (°C)	24.2						
Surface temp away fom HVS (°C)	25.5						
Surface temp under HVS (°C)	26.0						
Temp difference (°C) away from HVS	-4.4						
Temp difference (°C) under HVS	-2.2						
Max opening Movement (mm)	-0.257						
Max total joint horizontal movement (mm)	0.351						
Total temp difference (top - bottom) under HVS (°C)	5.8						
Max total 24h day to night temperature changes							
Air temp change: outside temp box (°C)	11.3						
Air temp change: inside temp box (°C)	11.1						
Surface temp change: outside temp box (°C)	19.0						
Surface temp change: inside temp box (°C)	7.4						

Table 4.28 Section 539FD Summary of JDMD Results (with HVS and Temperature Control Chamber)

		Critical Case	all JDMD data				
			1	2	3	4	5
JDMD 1 to 5: Vertical edge and corner movements							
Max downward Movement							
time of day	2:52 PM						
Outside open air temp (°C)	23.3						
Air temp: under the HVS (°C)	19.7						
Surface temp away fom HVS (°C)	30.9						
Surface temp under HVS (°C)	22.2						
Temp difference (°C) away from HVS	3.1						
Temp difference (°C) under HVS	-2.6						
Max downward Movement (mm)	-0.011	-0.011	-0.011	-0.006	-0.007	-0.007	
position	JDMD-2						
Max upward movement							
time of day	12:52 AM						
Outside air temp in open air	15.1						
Air temp: under the HVS	18.6						
Surface temp away fom HVS	18.9						
Surface temp under HVS	21.0						
Temp difference (°C) away from HVS	-9.0						
Temp difference (°C) under HVS	-2.4						
Max upward Movement (mm)	0.079	0.079	0.067	0.058	0.067	0.070	
position	JDMD-1						
Max total movement (mm)	0.090	0.089	0.078	0.063	0.074	0.077	
Total temp difference (top - bottom) under HVS (°C)	-0.2						
Horizontal slab edge movement							
time of day	12:51 PM						
Outside air temp in open air (°C)	22.4						
Air temp: under the HVS (°C)	20.2						
Surface temp away fom HVS (°C)	27.7						
Surface temp under HVS (°C)	22.1						
Temp difference (°C) away from HVS	4.2						
Temp difference (°C) under HVS	-2.5						
Max Closing Movement (mm)	0.0002						
time of day	8:52 AM						
Outside air temp in open air (°C)	16.5						
Air temp: under the HVS (°C)	18.3						
Surface temp away fom HVS (°C)	20.2						
Surface temp under HVS (°C)	20.4						
Temp difference (°C) away from HVS	-5.9						
Temp difference (°C) under HVS	-2.3						
Max opening Movement (mm)	-0.015						
Max total joint horizontal movement (mm)	0.015						
Total temp difference (top - bottom) under HVS (°C)	-0.2						
Max total 24h day to night temperature changes							
Air temp change: outside temp box (°C)	9.3						
Air temp change: inside temp box (°C)	2.7						
Surface temp change: outside temp box (°C)	14.2						
Surface temp change: inside temp box (°C)	2.4						

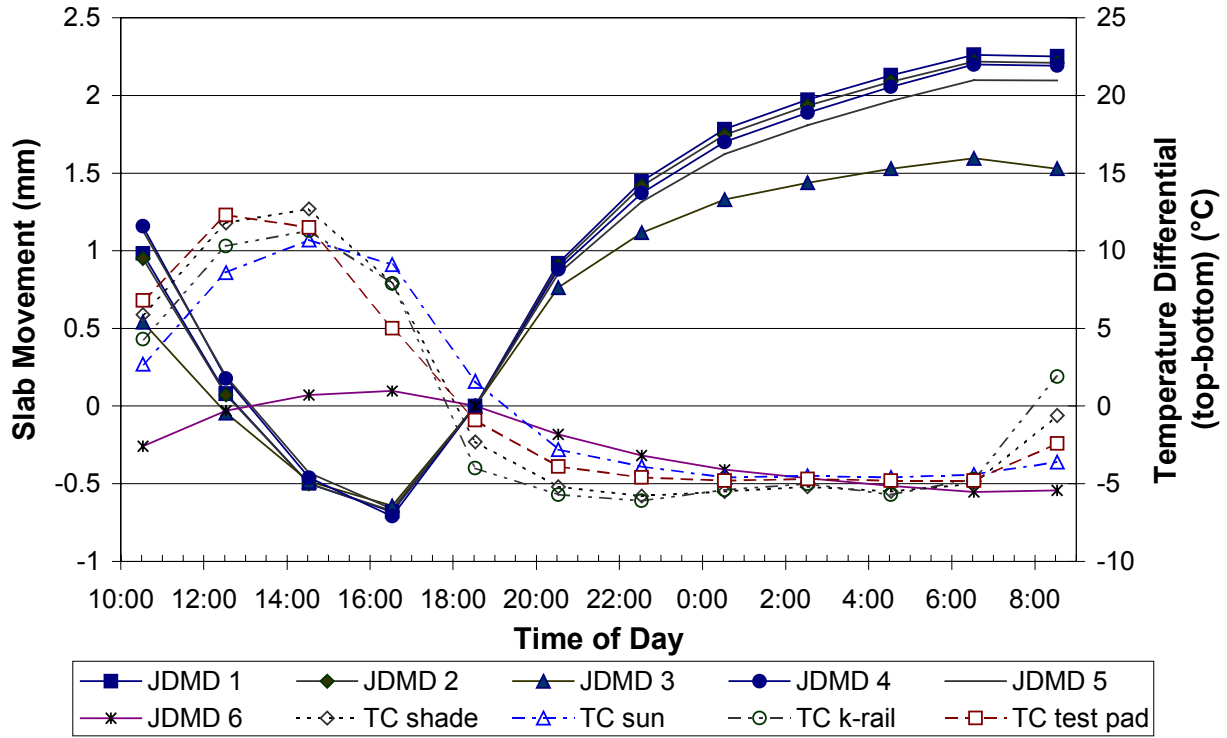

Figure 4.39. Section 539FD JDMD results (no HVS, no temperature control chamber).

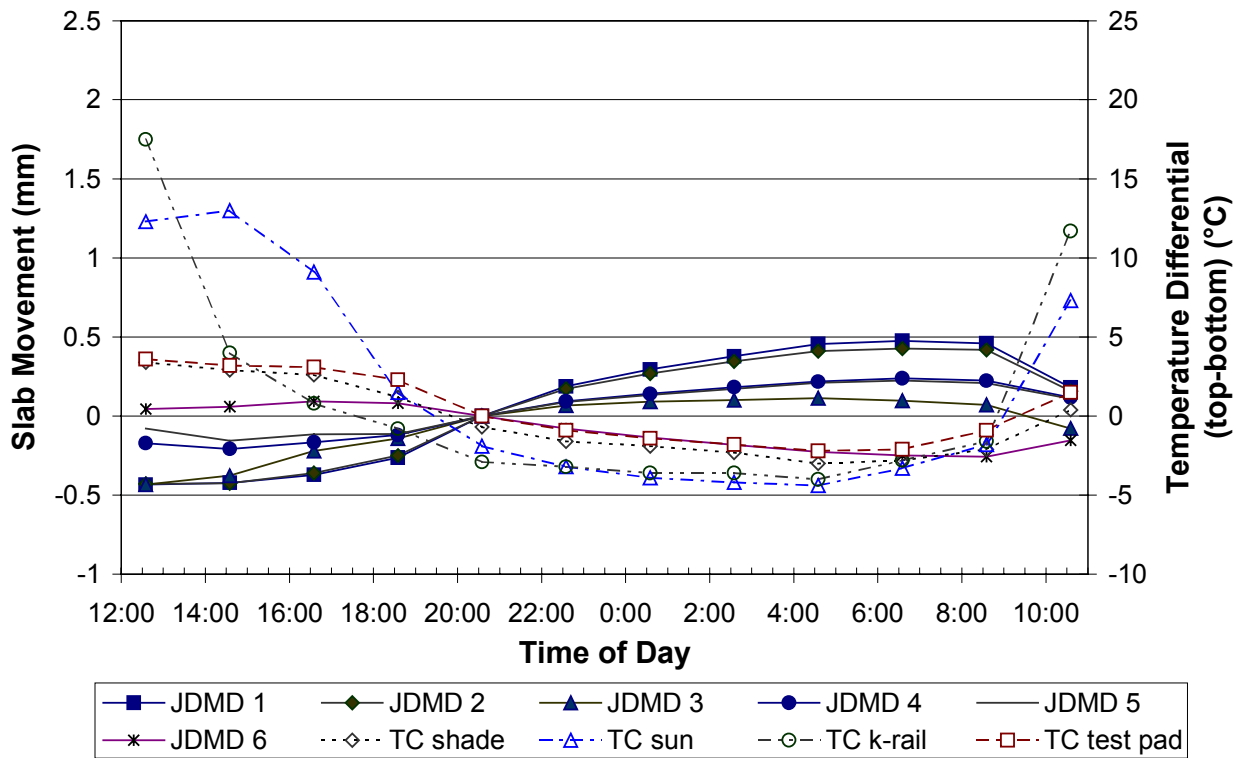

Figure 4.40. Section 539FD JDMD results (with HVS, no temperature control chamber).

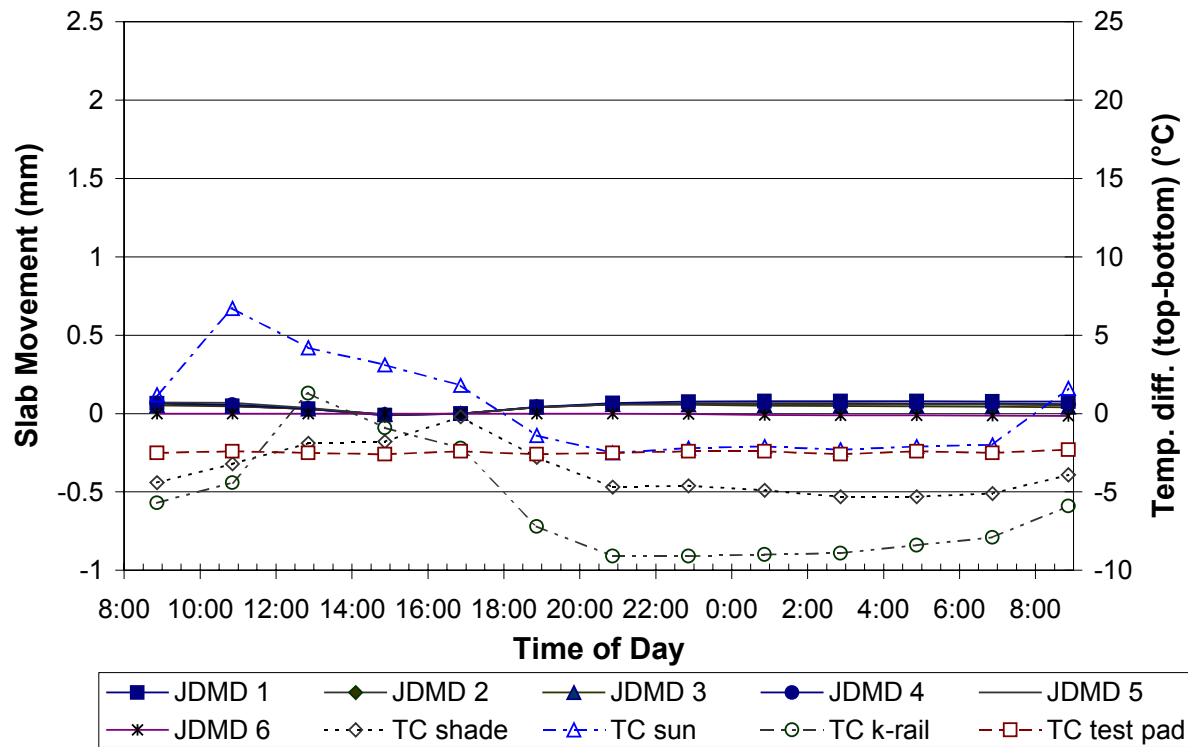

Figure 4.41. Section 539FD JDMD results (with HVS and temperature control chamber).

Table 4.29 Section 539FD Summary of JDMD Results

	No HVS	With HVS	With HVS and temperature chamber
Total max movement (mm)			
Vertical edge & corner movement	2.972	0.909	0.090
Horizontal transverse joint movement	0.650	0.351	0.015
Maximum temperature differences) (°C)			
On the test section (top - bottom)	17.5	5.7	-0.2
In the sun (top - bottom)	17.5	15.6	12.1
Day to night air temperature change	12.7	11.1	2.7

4.9.2 MDD data

Two MDDs were installed at Section 539FD on either side of Joint 11, between Slabs 11 (mid-slab) and 12. MDD 5 was placed 300 mm from Joint11 inside Slab 12. MDD 4 was placed 300 mm from Joint11 inside Slab 11.

The maximum movement was recorded with MDD 4 when the section was completely exposed to direct sunlight (1.104 mm) caused by a temperature differential of 13.8°C. The corresponding movement of MDD 5 was 0.559 mm. Table 4.30 summarizes the results for all three cases. The results are also presented in Figures 4.42 to 4.44. Figure 4.42 shows the two-hour lag between the maximum temperature differential and the maximum movement.

Table 4.30 Section 539FD Summary of MDD Results

MDD 4 & 5: Vertical movements	No HVS on site	HVS on site without temp box	HVS on site with temp box
Max upward movement			
time of day	6:32 AM	4:35 AM	6:52 AM
Outside open air temp (°C)	23.6	21.0	14.0
Air temp inside temp box (°C)	23.8	21.4	18.3
Surface temp in sun (°C)	24.6	23.4	16.7
Surface temp inside temp box (°C)	24.1	27.0	20.3
Temp difference in sun (°C)	-4.7	-5.0	-2.0
Temp difference inside temp box (°C)	-4.8	4.9	-2.5
MDD 5: Max upward movement (mm)	0.495	0.213	0.035
MDD 4: Max upward movement (mm)	0.9544	0.3303	0.0731
Max downward movement			
time of day	4:32 PM	6:35 PM	2:52 PM
Outside open air temp (°C)	34.6	28.0	23.3
Air temp inside temp box (°C)	35.1	28.5	19.7
Surface temp in sun (°C)	41.8	33.4	30.9
Surface temp inside temp box (°C)	37.2	28.2	22.2
Temp difference in sun (°C)	9.1	3.2	3.1
Temp difference inside temp box (°C)	8.0	2.1	-2.6
MDD 5: Max downward movement (mm)	-0.064	-0.057	0.0013
MDD 4: Max downward movement (mm)	-0.150	-0.103	0.0041
MDD 5: Maximum total movement (mm)	0.559	0.270	0.034
MDD 4: Maximum total movement (mm)	1.104	0.433	0.069
Total temp difference inside temp box (°C)	12.8	-2.8	-0.1
Total temp difference in the sun °C	13.8	8.2	5.1

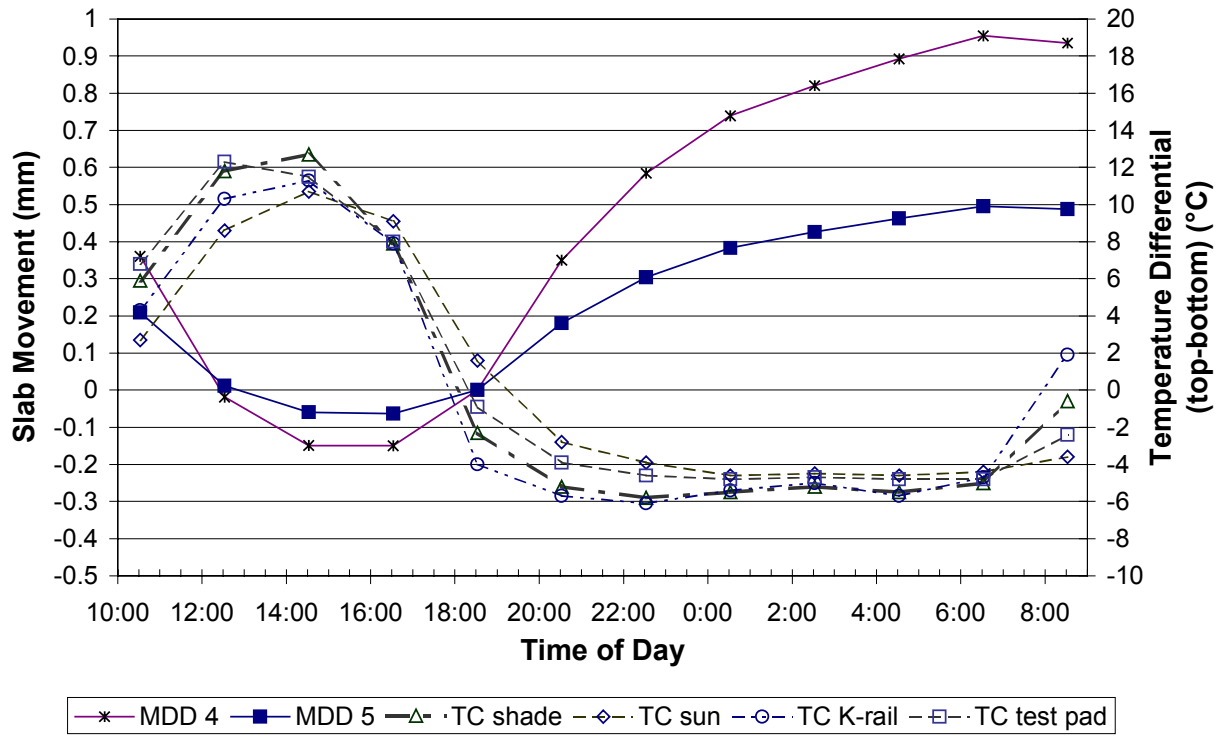

Figure 4.42. Section 539FD MDD results (no HVS, no temperature control chamber).

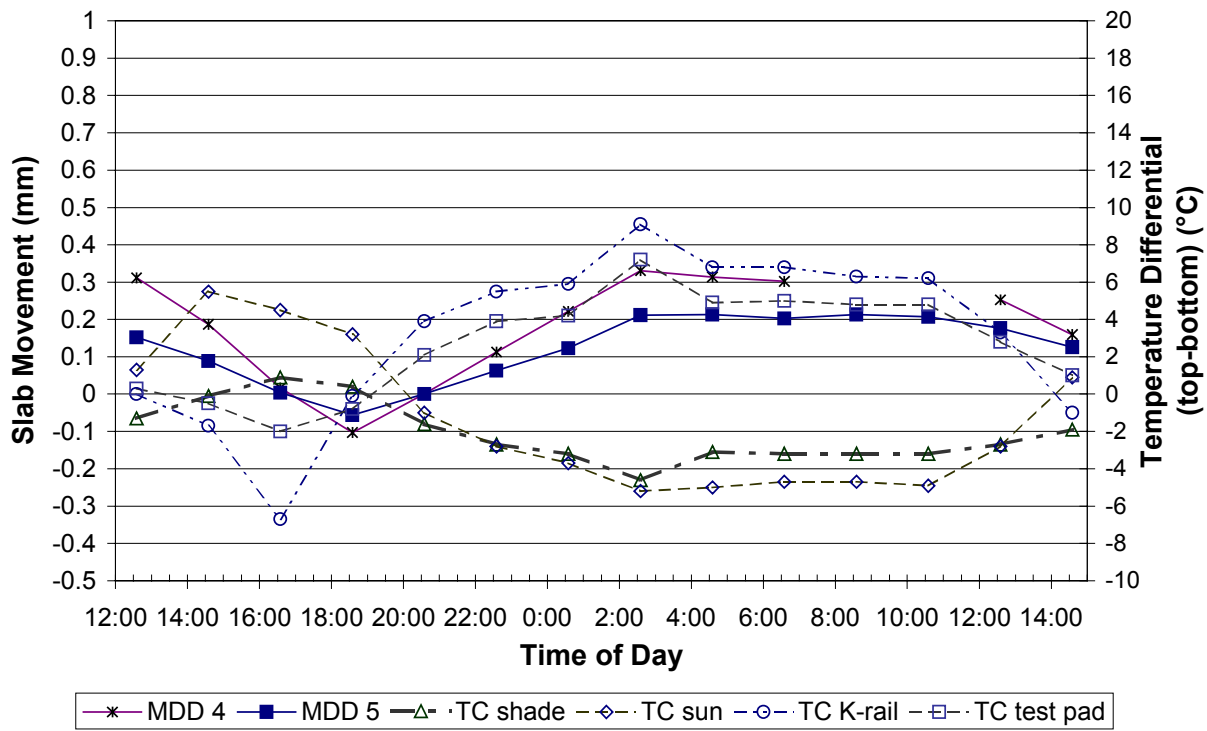

Figure 4.43. Section 539FD MDD results (with HVS, no temperature control chamber).

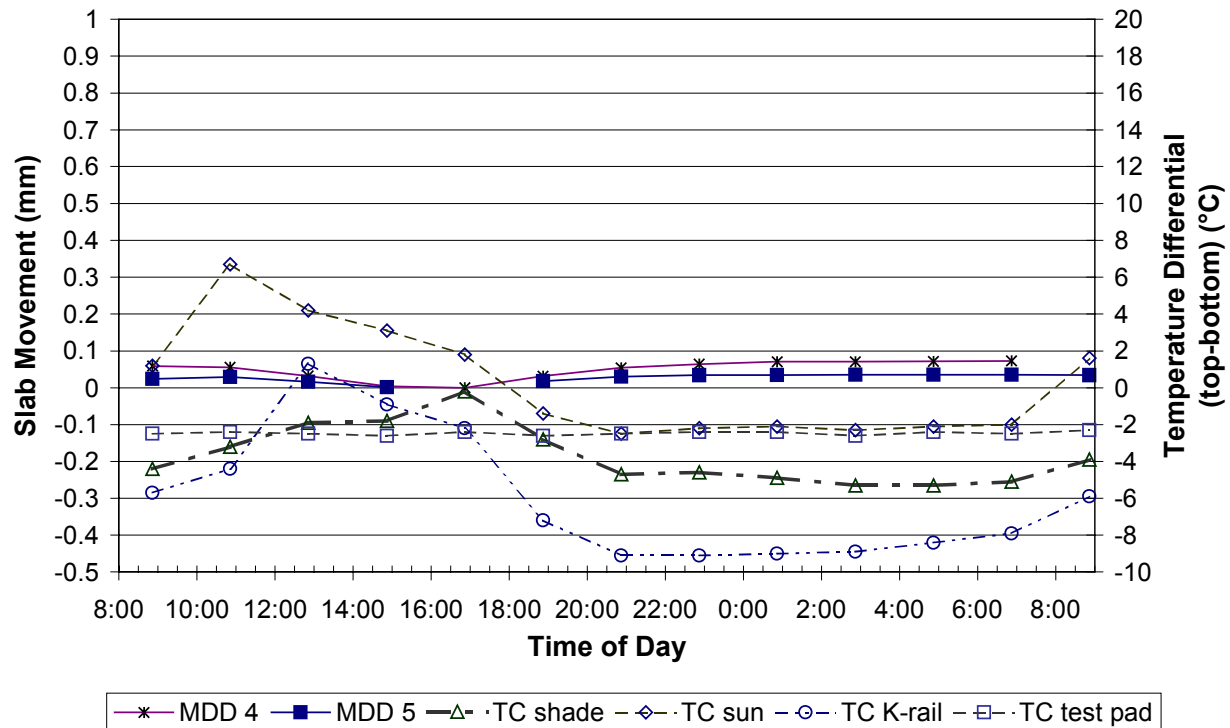

Figure 4.44. Section 539FD MDD results (with HVS and temperature control chamber).

4.10 Test 540FD

Test 540FD was the second test conducted on concrete slabs with dowels, an asphalt shoulder, and an increased lane width (4.3 m instead of the standard 3.7 m) (see Sec 3.0). Test 539FD was performed on Slabs 6, 7, and 8.

4.10.1 JDMD data

The results of all three cases (without the HVS, with the HVS, and with the HVS and the temperature control chamber in place) are summarized in Tables 4.31 to 4.33. The total JDMD movements over the 24-hour cycle can be seen in Figures 4.45 to 4.47. The results from all three cases are summarized in Table 4.34

When the complete section was exposed to sunlight, a maximum movement of 3.395 mm was recorded by JDMD 1 due to a temperature differential of 14.3°C. The other JDMDs (for the

same case) reported equally high values with JDMD 3 giving the lowest value (2.157 mm). The effect of the keeping the section at a constant temperature is highlighted in Table 4.34.

Maximum movement dropped from 3.395 mm (sections exposed to sunlight) to 0.479 mm (temperature control chamber in operation).

Table 4.31 Section 540FD Summary of JDMD Results (no HVS, no Temperature Control Chamber)

		Critical Case	all JDMD data				
			1	2	3	4	5
JDMD 1 to 5: Vertical edge and corner movements							
Max downward Movement							
time of day	1:57 PM						
Outside air temp (°C)	27.2						
Surface temp (°C)	32.6						
Temp difference at time of max movement (°C)	7.5						
Max downward Movement (mm)	-1.252	-1.252	-1.203	-0.847	-1.105	-1.075	
position	JDMD-1						
Max upward Movement							
time of day	6:04 AM						
Outside air temp (°C)	14.9						
Surface temp (°C)	15.8						
Temp difference (°C)	-6.8						
Max upward Movement (mm)	2.143	2.143	2.021	1.310	1.623	1.562	
position	JDMD-1						
Maximum total movement (mm)	3.395	3.395	3.224	2.157	2.729	2.637	
Total temp difference (top - bottom) (°C)	14.3						
Horizontal slab edge movement JDMD 6							
time of day	3:05 PM						
Outside air temp (°C)	26.6						
Surface temp (°C)	32.7						
Temp difference (°C)	4.8						
Max Closing Movement (mm)	0.170						
time of day	6:04 AM						
Outside air temp (°C)	14.9						
Surface temp (°C)	15.8						
Temp difference (°C)	-6.8						
Max opening Movement (mm)	-0.510						
Max total joint horizontal movement (mm)	0.680						
Total temp difference (top-bottom) (°C)	11.6						
Max total 24h day to night temperature changes							
Air temp change: outside temp box (°C)	12.4						
Air temp change: inside temp box (°C)	12.4						
Surface temp change: outside temp box (°C)	16.8						
Surface temp change: inside temp box (°C)	16.8						

Table 4.32 Section 540FD Summary of JDMD Results (with HVS, without Temperature Control Chamber)

		Critical Case	all JDMD data				
			1	2	3	4	5
JDMD 1 to 5: Vertical edge and corner movements							
Max downward Movement							
time of day	4:08 PM						
Outside open air temp (°C)	23.6						
Air temp: under the HVS (°C)	23.7						
Surface temp away fom HVS (°C)	28.3						
Surface temp under HVS (°C)	28.0						
Temp difference (°C) away from HVS	3.1						
Temp difference (°C) under HVS	4.7						
Max downward Movement (mm)	-0.701	-0.701	-0.688	-0.420	-0.452	-0.434	
position	JDMD-1						
Max upward movement							
time of day	12:01 AM						
Outside air temp in open air	17.3						
Air temp: under the HVS	17.7						
Surface temp away fom HVS	18.4						
Surface temp under HVS	18.7						
Temp difference (°C) away from HVS	-3.6						
Temp difference (°C) under HVS	-4.2						
Max upward Movement (mm)	0.947	0.947	0.921	0.585	0.719	0.674	
position	JDMD-1						
Max total movement (mm)	1.647	1.647	1.608	1.005	1.171	1.108	
Total temp difference (top - bottom) under HVS (°C)	8.9						
Horizontal slab edge movement							
time of day	4:08 PM						
Outside air temp in open air (°C)	23.6						
Air temp: under the HVS (°C)	23.7						
Surface temp away fom HVS (°C)	28.3						
Surface temp under HVS (°C)	28.0						
Temp difference (°C) away from HVS	3.1						
Temp difference (°C) under HVS	4.7						
Max Closing Movement (mm)	0.111						
time of day	12:01 AM						
Outside air temp in open air (°C)	17.3						
Air temp: under the HVS (°C)	17.7						
Surface temp away fom HVS (°C)	18.4						
Surface temp under HVS (°C)	18.7						
Temp difference (°C) away from HVS	-3.6						
Temp difference (°C) under HVS	-4.2						
Max opening Movement (mm)	-0.154						
Max total joint horizontal movement (mm)	0.265						
Total temp difference (top - bottom) under HVS (°C)	8.9						
Max total 24h day to night temperature changes							
Air temp change: outside temp box (°C)	8.1						
Air temp change: inside temp box (°C)	7.2						
Surface temp change: outside temp box (°C)	12.7						
Surface temp change: inside temp box (°C)	9.4						

Table 4.33 Section 540FD Summary of JDMD Results (with HVS and Temperature Control Chamber)

		Critical Case	all JDMD data				
			1	2	3	4	5
JDMD 1 to 5: Vertical edge and corner movements							
Max downward Movement							
time of day	1:15 PM						
Outside open air temp (°C)	27.0						
Air temp: under the HVS (°C)	21.4						
Surface temp away fom HVS (°C)	35.5						
Surface temp under HVS (°C)	22.3						
Temp difference (°C) away from HVS	8.9						
Temp difference (°C) under HVS	-2.2						
Max downward Movement (mm)	-0.321	-0.321	-0.226	-0.242	-0.301	-0.290	
position	JDMD-1						

Max upward movement						
time of day	5:15 AM					
Outside air temp in open air	14.8					
Air temp: under the HVS	18.3					
Surface temp away fom HVS	16.3					
Surface temp under HVS	19.3					
Temp difference (°C) away from HVS	-6.2					
Temp difference (°C) under HVS	-2.8					
Max upward Movement (mm)	0.252	-0.308	0.252	0.103	0.072	0.081
position	JDMD-2					
Max total movement (mm)	0.479	0.013	0.479	0.344	0.373	0.371
Total temp difference (top - bottom) under HVS (°C)	0.6					

Horizontal slab edge movement						
time of day	1:15 PM					
Outside air temp in open air (°C)	27.0					
Air temp: under the HVS (°C)	21.4					
Surface temp away fom HVS (°C)	35.5					
Surface temp under HVS (°C)	22.3					
Temp difference (°C) away from HVS	8.9					
Temp difference (°C) under HVS	-2.2					
Max Closing Movement (mm)	0.0638					
time of day	5:15 AM					
Outside air temp in open air (°C)	14.5					
Air temp: under the HVS (°C)	18.3					
Surface temp away fom HVS (°C)	16.3					
Surface temp under HVS (°C)	19.3					
Temp difference (°C) away from HVS	-6.2					
Temp difference (°C) under HVS	-2.8					
Max opening Movement (mm)	-0.056					
Max total joint horizontal movement (mm)	0.119					
Total temp difference (top - bottom) under HVS (°C)	0.6					

Max total 24h day to night temperature changes	
Air temp change: outside temp box (°C)	12.5
Air temp change: inside temp box (°C)	3.5
Surface temp change: outside temp box (°C)	20.2
Surface temp change: inside temp box (°C)	3.5

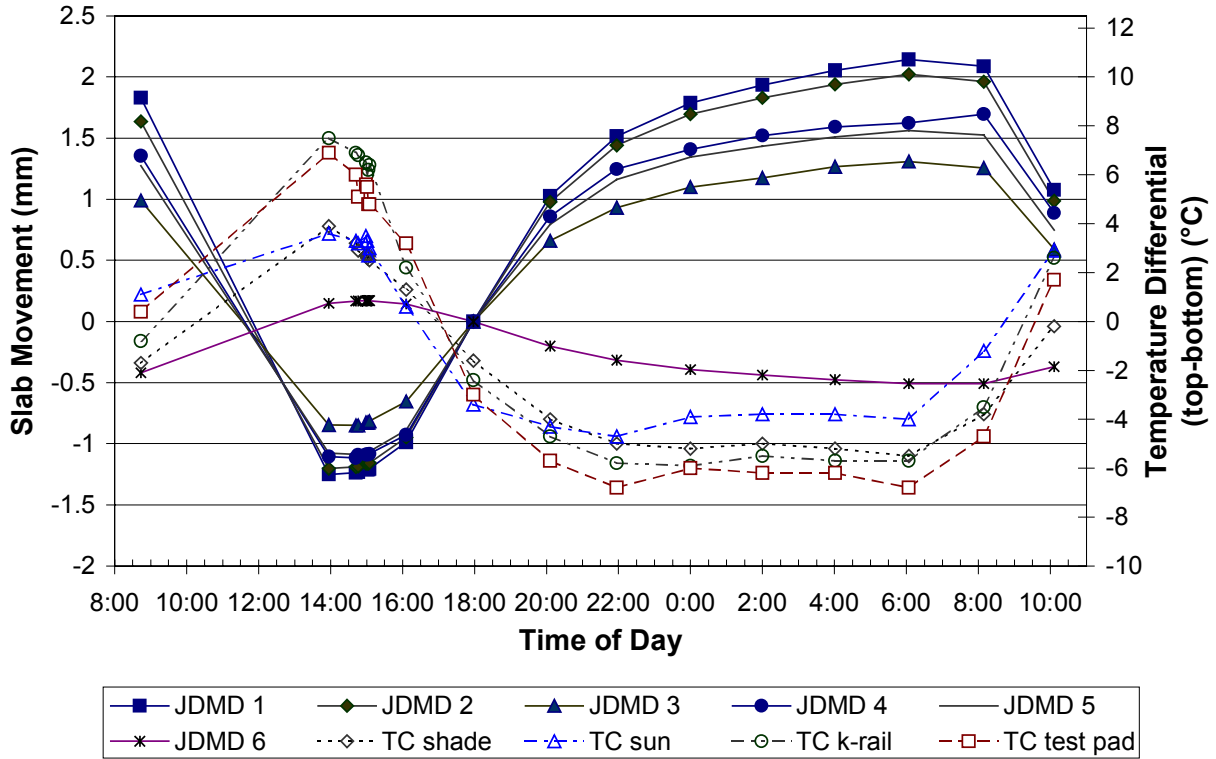

Figure 4.45. Section 540FD JDMD results (no HVS, no temperature control chamber).

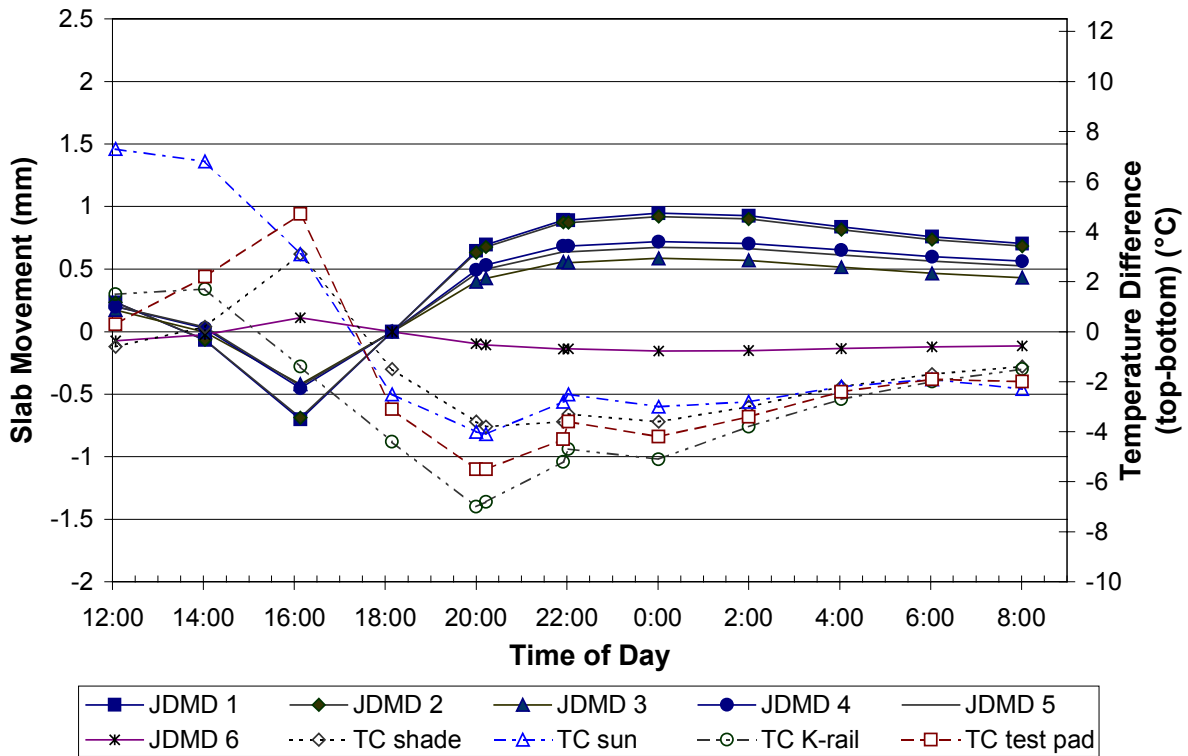

Figure 4.46. Section 540FD JDMD results (with HVS, no temperature control chamber).

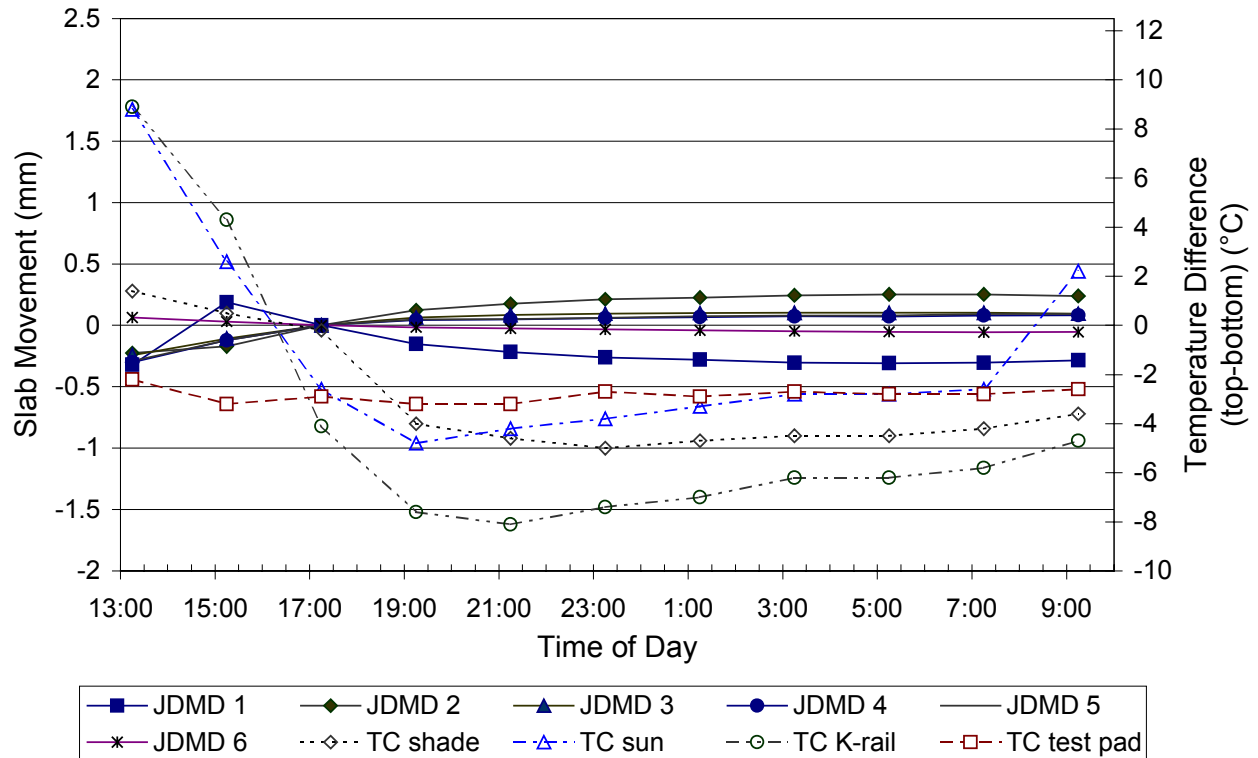

Figure 4.47. Section 540FD JDMD results (with HVS and temperature control chamber).

Table 4.34 Section 540FD Summary of JDMD Results

	No HVS	With HVS	With HVS and temperature chamber
Total max movement (mm)			
Vertical edge & corner movement	3.395	1.647	0.479
Horizontal transverse joint movement	0.680	0.265	0.119
Maximum temperature differences) (°C)			
On the test section (top - bottom)	14.3	8.9	0.6
In the sun (top - bottom)	14.3	6.7	15.1
Day to night air temperature change	12.4	7.2	3.5

4.10.2 MDD data

Two MDDs were installed at Section 540FD on either side of Joint 7, between Slab 7 (mid-slab) and Slab 8. MDD 3 was placed 300 mm from Joint 7 on Slab 8 and MDD 2 was placed 300 mm from Joint 11 on Slab 7.

The maximum movement was recorded with MDD 3 (1.425 mm) when the section was completely exposed to direct sunlight and experienced a temperature differential of 13.7°C. The corresponding movement of MDD 2 was 0.142 mm. In all cases, MDD 2 consistently showed very low movements in comparison with MDD 3, while both instruments were subjected to the same environmental loading conditions. It was therefore concluded that MDD 2 was not working properly. Consequently, MDD 2 results are not presented in this report. The data for MDD 3 for all three cases is summarized in Table 4.35 and shown in Figures 4.48–4.50.

Table 4.35 Section 540FD Summary of MDD Results

MDD 2 & 3: Vertical movements	No HVS on site	HVS on site without temp box	HVS on site with temp box
Max upward movement			
time of day	6:04 AM	12:01 AM	7:15 AM
Outside open air temp (°C)	14.9	17.3	14.5
Air temp inside temp box (°C)	17.5	17.7	17.9
Surface temp in sun (°C)	16.4	18.4	15.8
Surface temp inside temp box (°C)	15.8	18.7	18.8
Temp difference in sun (°C)	-5.5	-3	-2.6
Temp difference inside temp box (°C)	-6.8	-4.2	-2.8
MDD 3: Max upward movement (mm)	0.9858	0.4275	0.1675
MDD 2: Max upward movement (mm)	MDD not functioning properly		
Max downward movement			
time of day	1:57 PM	4:08 PM	1:15 PM
Outside open air temp (°C)	27.2	23.6	27
Air temp inside temp box (°C)	28	23.7	21.4
Surface temp in sun (°C)	32.3	28.3	35.5
Surface temp inside temp box (°C)	32.6	28	22.3
Temp difference in sun (°C)	3.6	3.1	8.8
Temp difference inside temp box (°C)	6.9	4.7	-2.2
MDD 3: Max downward movement (mm)	-0.4390	-0.0800	-0.1586
MDD 2: Max downward movement (mm)	MDD not functioning properly		
MDD 3: Maximum total movement (mm)	1.425	0.507	0.326
MDD 2: Maximum total movement (mm)	MDD not functioning properly		
Total temp difference inside temp box (°C)	13.7	8.9	0.6
Total temp difference in the sun °C	9.1	6.1	11.4

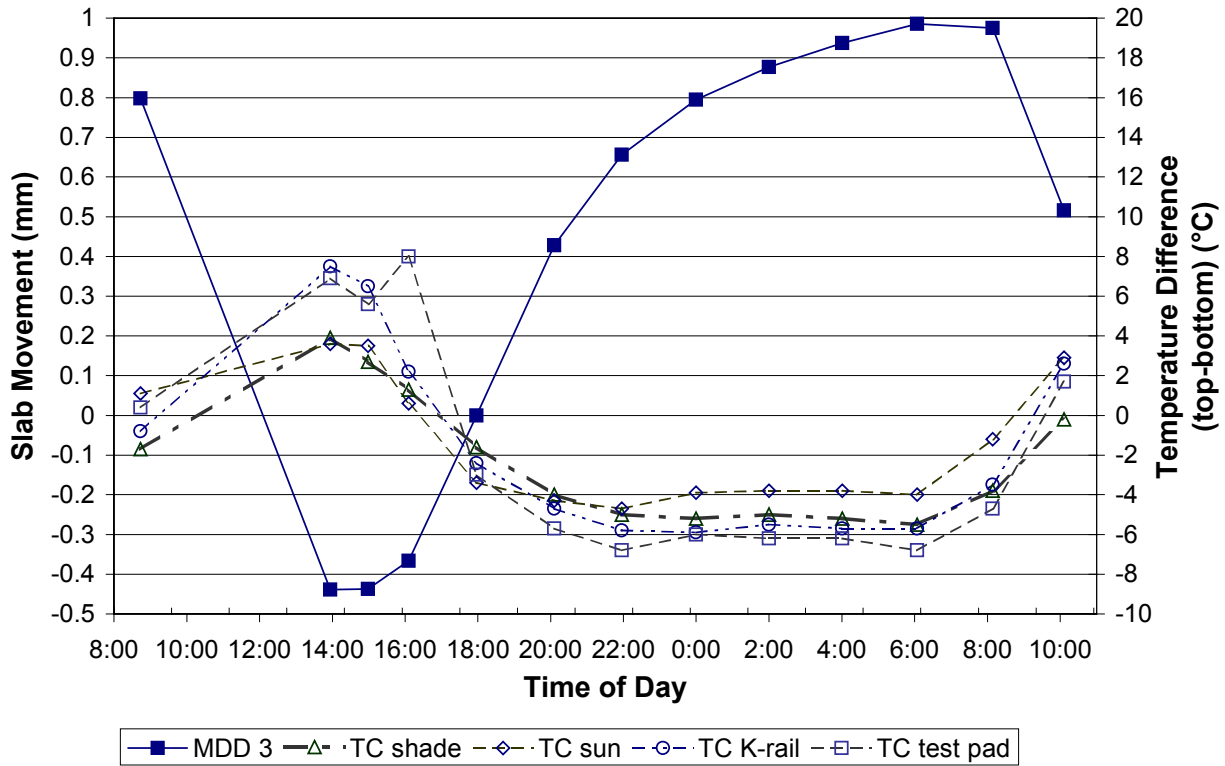

Figure 4.48. Section 540FD MDD results (no HVS, no temperature control chamber).

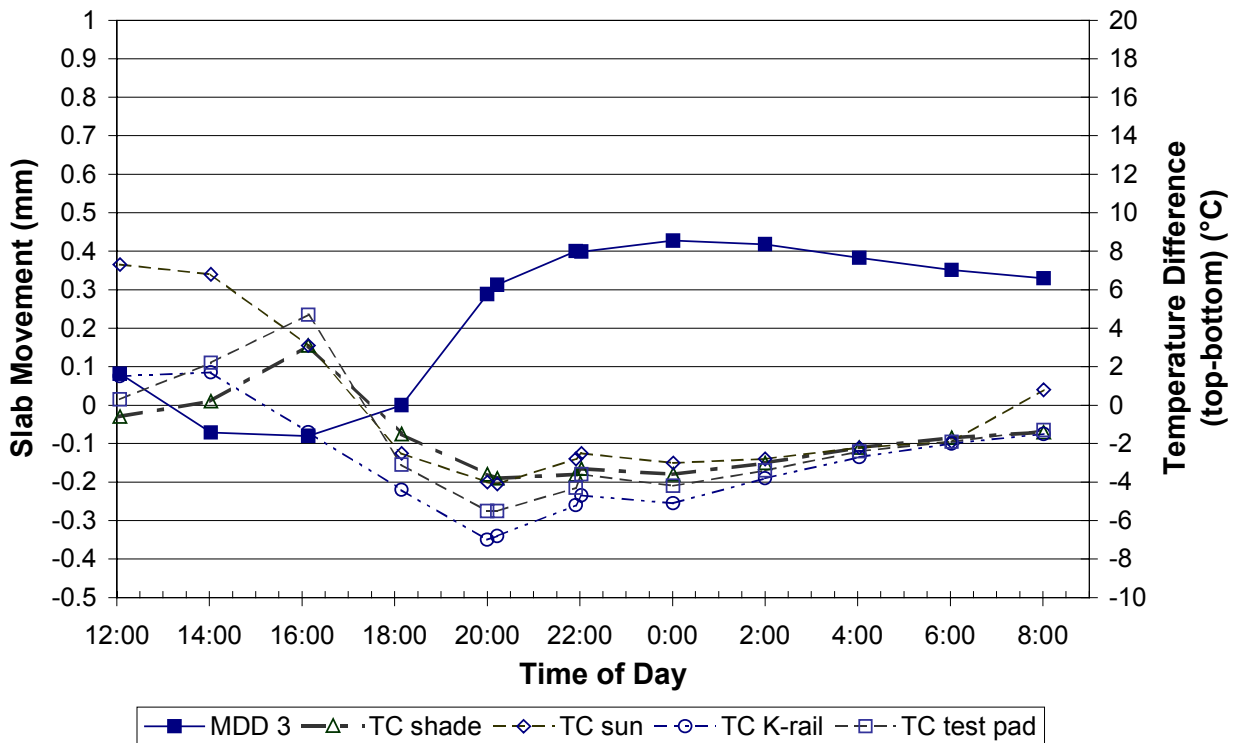

Figure 4.49. Section 540FD MDD results (with HVS, no temperature control chamber).

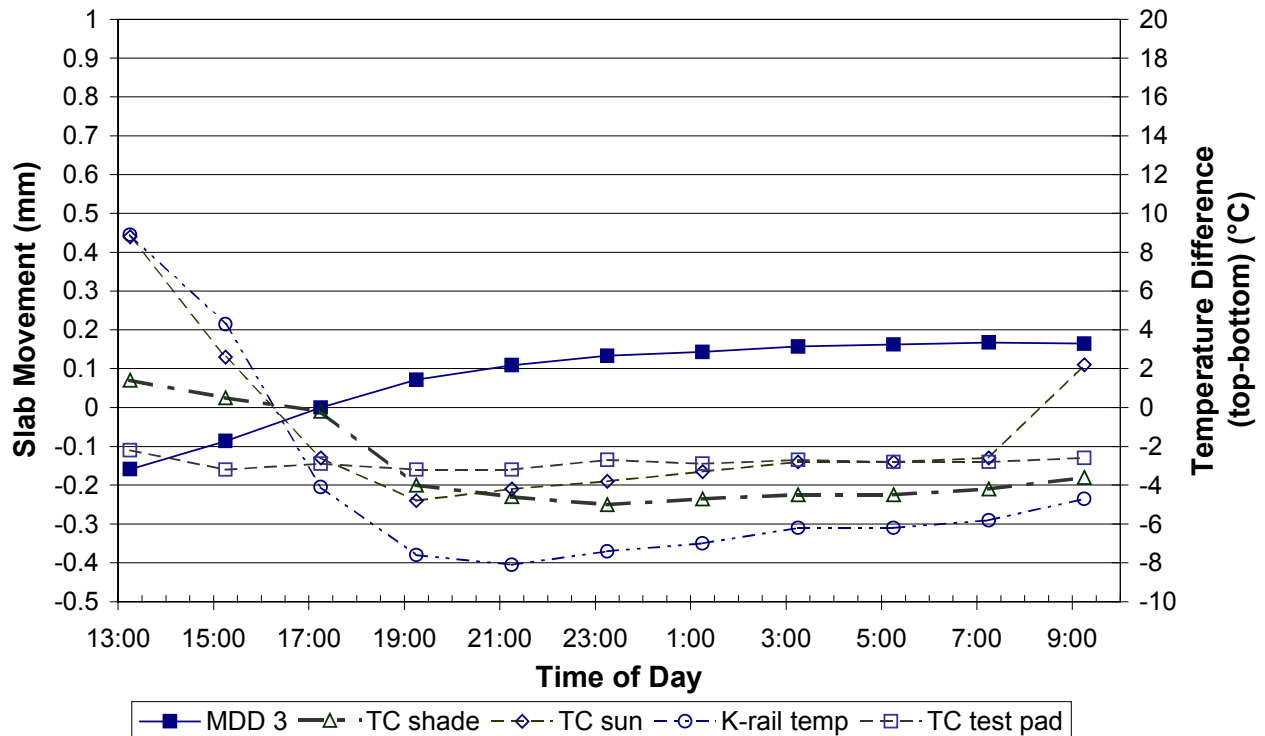

Figure 4.50. Section 540FD MDD results (with HVS and temperature control chamber).

4.11 Test 541FD

Test 541FD was the last of the series of tests conducted on concrete slabs with dowels, an asphalt shoulder, and an increased lane width (4.3 m instead of the standard 3.7 m) (see Section 3.0). Test 541FD was performed on Slabs 2, 3, and 4. The temperature control chamber was not used. JDMDs and strain gauges were installed. Unfortunately, the strain gauges did not produce any useful results and data from these instruments are not included in this report.

4.11.1 JDMD Data

The results of both cases (without the HVS and with the HVS parked on the section) are summarized in Tables 4.36 and 4.37. The total JDMD movements over the 24-hour cycle are presented in Figures 4.51 and 4.52. The results from both cases are summarized in Table 4.38.

Table 4.36 Section 541FD Summary of JDMD Results (no HVS, no Temperature Control Chamber)

		Critical Case	all JDMD data				
			1	2	3	4	5
JDMD 1 to 5: Vertical edge and corner movements							
Max downward Movement							
time of day	1:00 PM						
Outside air temp (°C)	23.6						
Surface temp (°C)	24.0						
Temp difference at time of max movement (°C)	8.3						
Max downward Movement (mm)	-0.8777	-0.8777	-0.8457	-0.4216	-0.6978	-0.6726	
position	JDMD-1						
Max upward Movement							
time of day	7:00 AM						
Outside air temp (°C)	10.9						
Surface temp (°C)	9.7						
Temp difference (°C)	-4.0						
Max upward Movement (mm)	0.8782	0.878	0.843	0.537	0.692	0.695	
position	JDMD-1						
Maximum total movement (mm)	1.7559	1.7559	1.6885	0.9587	1.3896	1.3674	
Total temp difference (top - bottom) (°C)	12.3						
Horizontal slab edge movement JDMD 6							
time of day	3:00 PM						
Outside air temp (°C)	22.1						
Surface temp (°C)	20.6						
Temp difference (°C)	4.1						
Max Closing Movement (mm)	0.1404						
time of day	7:00 AM						
Outside air temp (°C)	10.9						
Surface temp (°C)	9.7						
Temp difference (°C)	-4.0						
Max opening Movement (mm)	-0.2190						
Max total joint horizontal movement (mm)	0.359						
Total temp difference (top-bottom) (°C)	8.1						
Max total 24h day to night temperature changes							
Air temp change: outside temp box (°C)	10.8						
Air temp change: inside temp box (°C)	12.7						
Surface temp change: outside temp box (°C)	12.9						
Surface temp change: inside temp box (°C)	14.3						

Table 4.37 Section 541FD Summary of JDMD Results (with HVS, without Temperature Control Chamber)

		Critical Case	all JDMD data				
			1	2	3	4	5
JDMD 1 to 5: Vertical edge and corner movements							
Max downward Movement							
time of day	3:01 PM						
Outside open air temp (°C)	19.7						
Air temp: under the HVS (°C)	18.6						
Surface temp away fom HVS (°C)	20.5						
Surface temp under HVS (°C)	19.3						
Temp difference (°C) away from HVS	2.8						
Temp difference (°C) under HVS	3.5						
Max downward Movement (mm)	-0.436	-0.436	-0.427	-0.206	-0.330	-0.305	
position	JDMD-1						
Max upward movement							
time of day	3:01 AM						
Outside air temp in open air	11.6						
Air temp: under the HVS	12.2						
Surface temp away fom HVS	12.2						
Surface temp under HVS	12.8						
Temp difference (°C) away from HVS	-3.2						
Temp difference (°C) under HVS	-2.5						
Max upward Movement (mm)	0.628	0.628	0.616	0.329	0.492	0.470	
position	JDMD-1						
Max total movement (mm)	1.064	1.064	1.043	0.535	0.822	0.775	
Total temp difference (top - bottom) under HVS (°C)	6.0						
Horizontal slab edge movement							
time of day	3:01 PM						
Outside air temp in open air (°C)	19.7						
Air temp: under the HVS (°C)	18.6						
Surface temp away fom HVS (°C)	20.5						
Surface temp under HVS (°C)	19.3						
Temp difference (°C) away from HVS	2.8						
Temp difference (°C) under HVS	3.5						
Max Closing Movement (mm)	0.104						
time of day	7:01 AM						
Outside air temp in open air (°C)	11.9						
Air temp: under the HVS (°C)	12.7						
Surface temp away fom HVS (°C)	12.7						
Surface temp under HVS (°C)	13.1						
Temp difference (°C) away from HVS	-2.4						
Temp difference (°C) under HVS	-2.3						
Max opening Movement (mm)	-0.137						
Max total joint horizontal movement (mm)	0.242						
Total temp difference (top - bottom) under HVS (°C)	5.8						
Max total 24h day to night temperature changes							
Air temp change: outside temp box (°C)	8.1						
Air temp change: inside temp box (°C)	6.4						
Surface temp change: outside temp box (°C)	10.3						
Surface temp change: inside temp box (°C)	7.2						

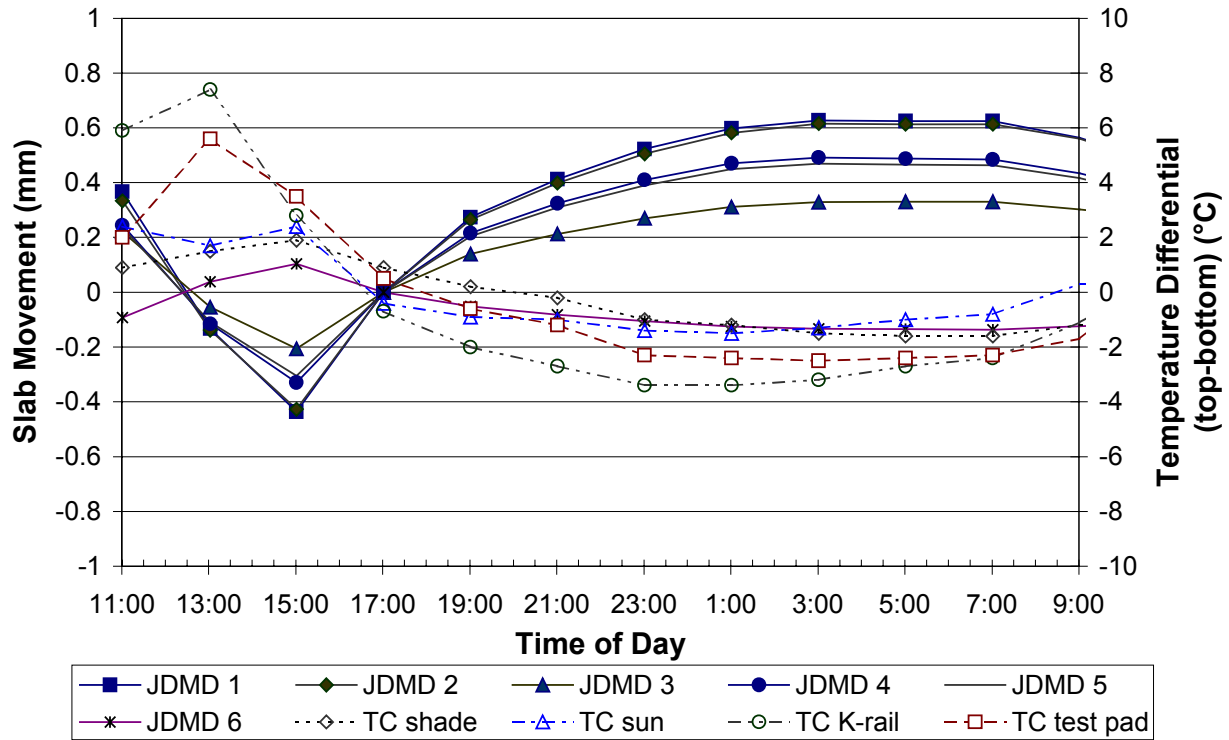

Figure 4.51. Section 541FD JDMD results (no HVS, no temperature control chamber).

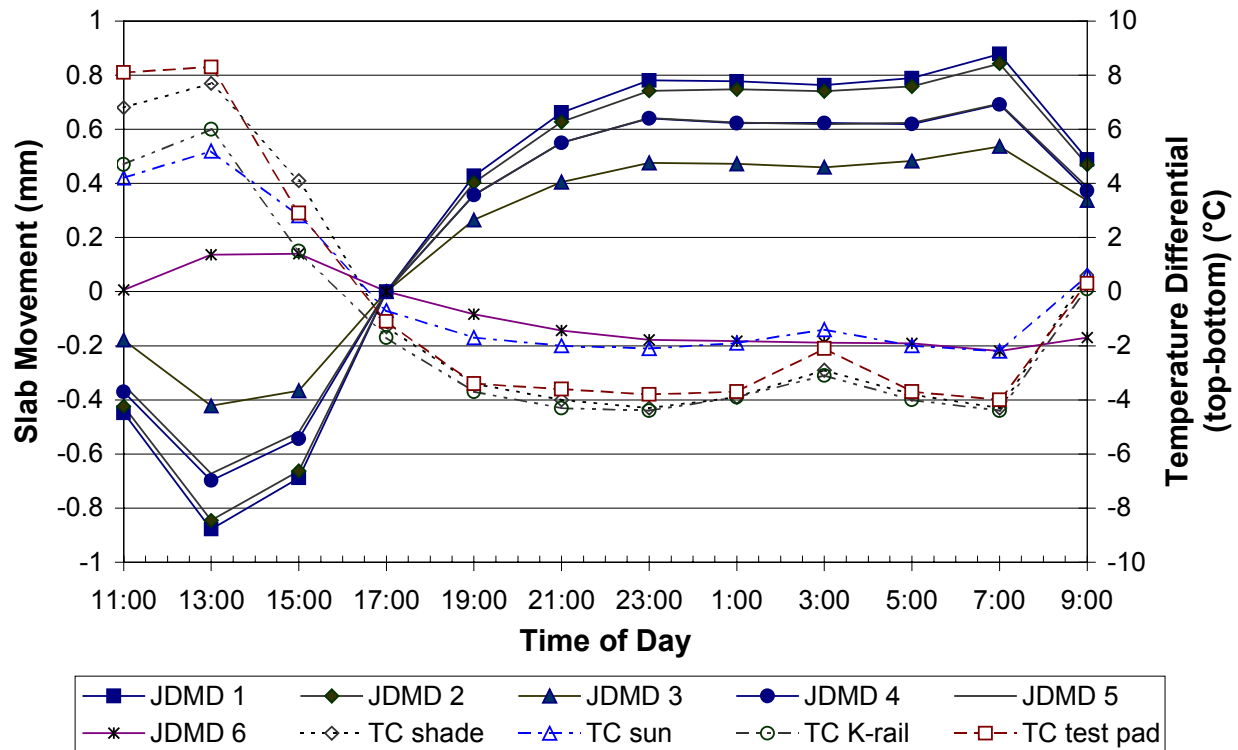

Figure 4.52. Section 541FD JDMD results (with HVS, no temperature control chamber).

Table 4.38 Section 541FD Summary of JDMD Results

	No HVS	With HVS
Total max movement (mm)		
Vertical edge & corner movement	1.756	1.064
Horizontal transverse joint movement	0.359	0.242
Maximum temperature differences) (°C)		
On the test section (top - bottom)	12.3	6.0
In the sun (top - bottom)	12.3	6.0
Day to night air temperature change	12.7	6.4

A maximum vertical movement of 1.756 mm was recorded by JDMD 1 due to a temperature differential of 12.3°C when the entire section was exposed to sunlight. The maximum vertical movement dropped to 1.064 mm when the HVS was parked on the section due to a temperature differential of 6.0°C under the HVS.

A maximum horizontal movement of 0.359 mm was recorded under the influence of a total day-to-night surface temperature change of 14.3°C. This decreased to 0.242 mm when the HVS was parked on the section (total day-to-night surface temperature change in this case was 7.2°C).

5.0 DISCUSSION OF THE JDMD RESULTS

The previous sections present the results obtained for each test undertaken (Tests 534FD through 541FD). It is apparent that the JDMDs provided the most consistently reliable and practically useful results compared with the strain gauges and MDDs, probably largely attributable to the location of the gauges on or near positions that would be expected to have greatest movements (especially slab corners and across joints).

This section reviews the JDMD data of all the tests in order to provide more specific insight into the slab behavior and the differences between the three design sections.

The following subsections assess the general responses of the test sections, the specific temperature responses of the edges, corners and joints, and the movements across joints.

5.1 General Response of the Test Sections

Figures 5.1 to 5.9 provide the comprehensive test histories for Sections 534FD to 541FD. In each figure, the upper graph presents the raw (unprocessed) readings of each JDMD plotted against time; the lower graph gives corresponding temperature data. For this comparison, the temperature data shown are the air temperatures and the test slab temperatures (designated TC test pad). Thus, the possibly less influential thermocouple temperature measurement locations (designated TC shade, sun and K-rail) are not used in this discussion. The less influential temperature data is omitted in order to try and provide a reasonable overview of a complex interaction of temperature-induced movements on the slabs, arising from the fact that the test slabs were not subjected to a uniform temperature regime over their entire areas.

In all but one case (Test 540FD), the chronological scale (x-axis) has been set to show all the data for the particular test on one figure. Although in cases in which the test sequence is spread over a longer period (notably Tests 535FD, 536FD, and 537FD, shown in Figures 5.2 to

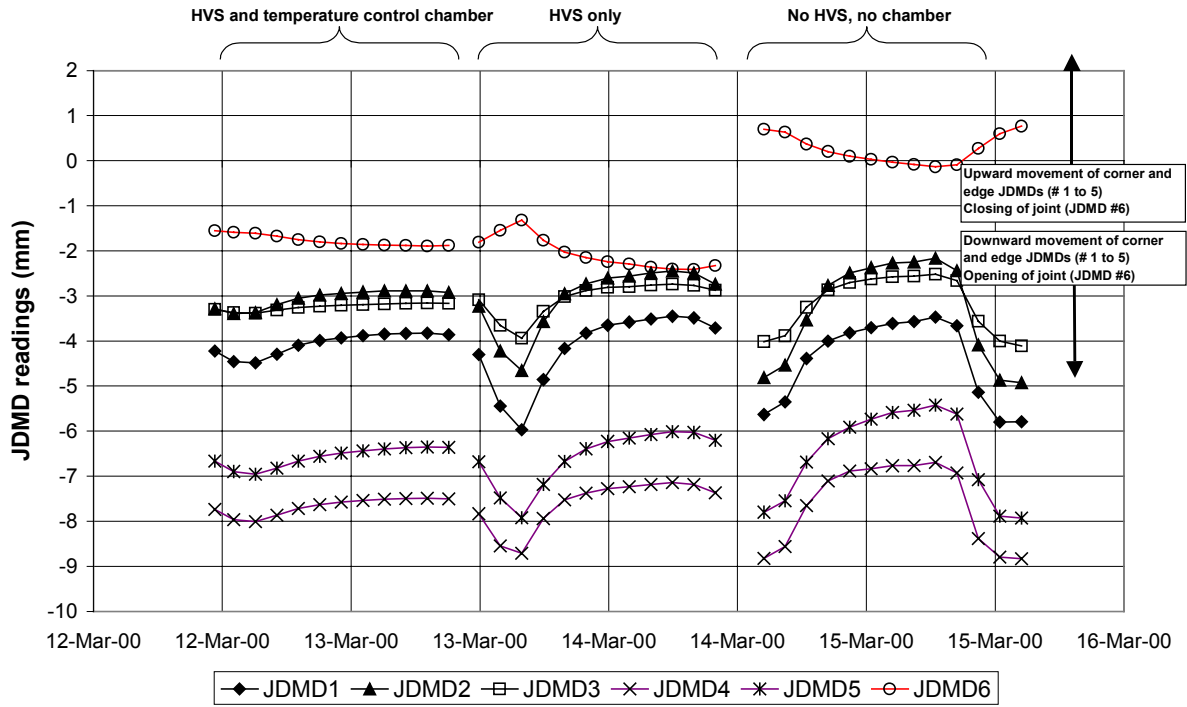

Figure 5.1a. Section 534 JDMD responses—raw data.

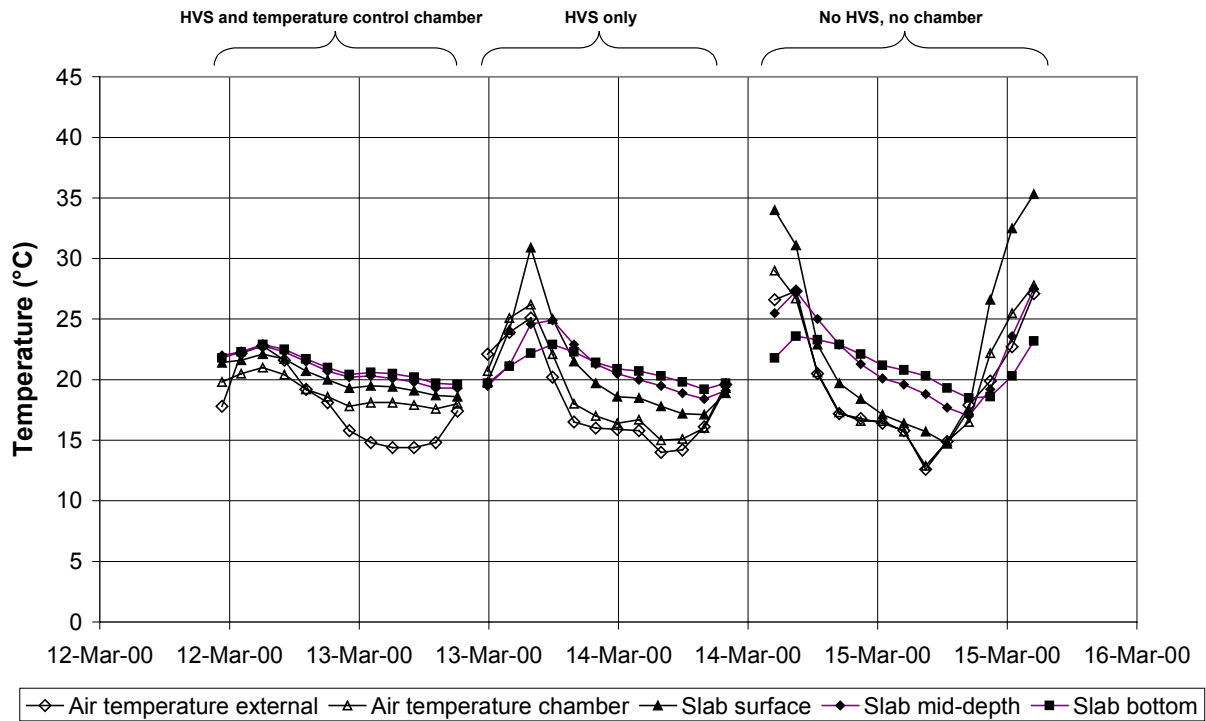

Figure 5.1b. Section 534FD selected temperature measurements.

Figure 5.1. Section 534FD test history.

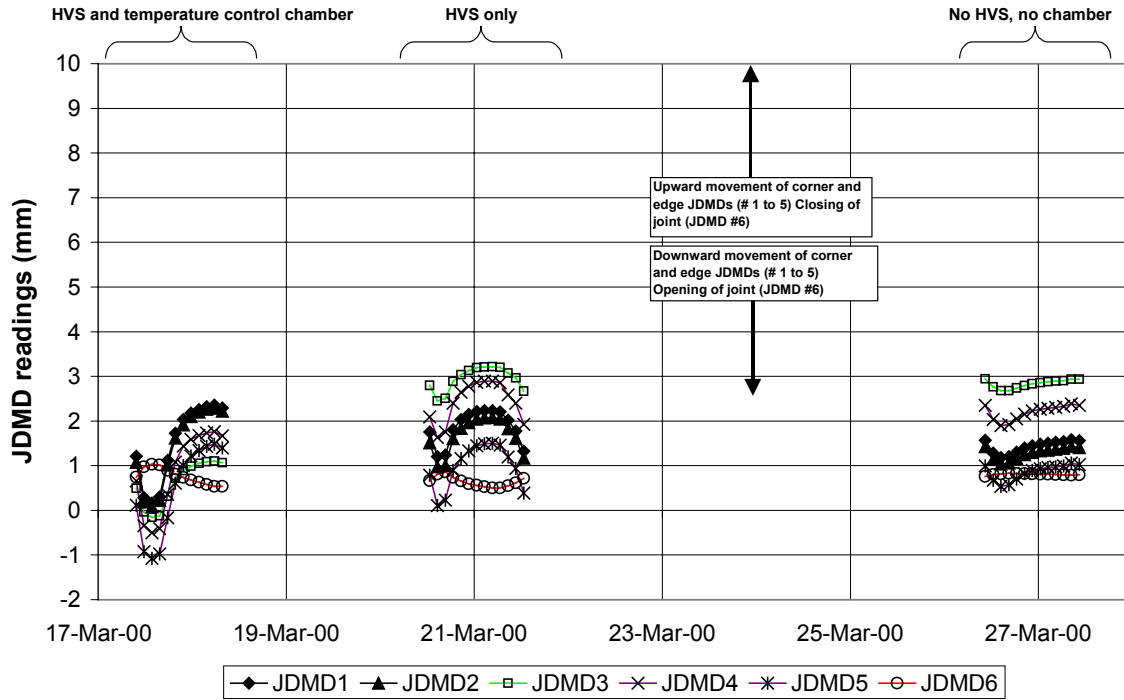

Figure 5.2a. Section 535FD JDMD responses—raw data.

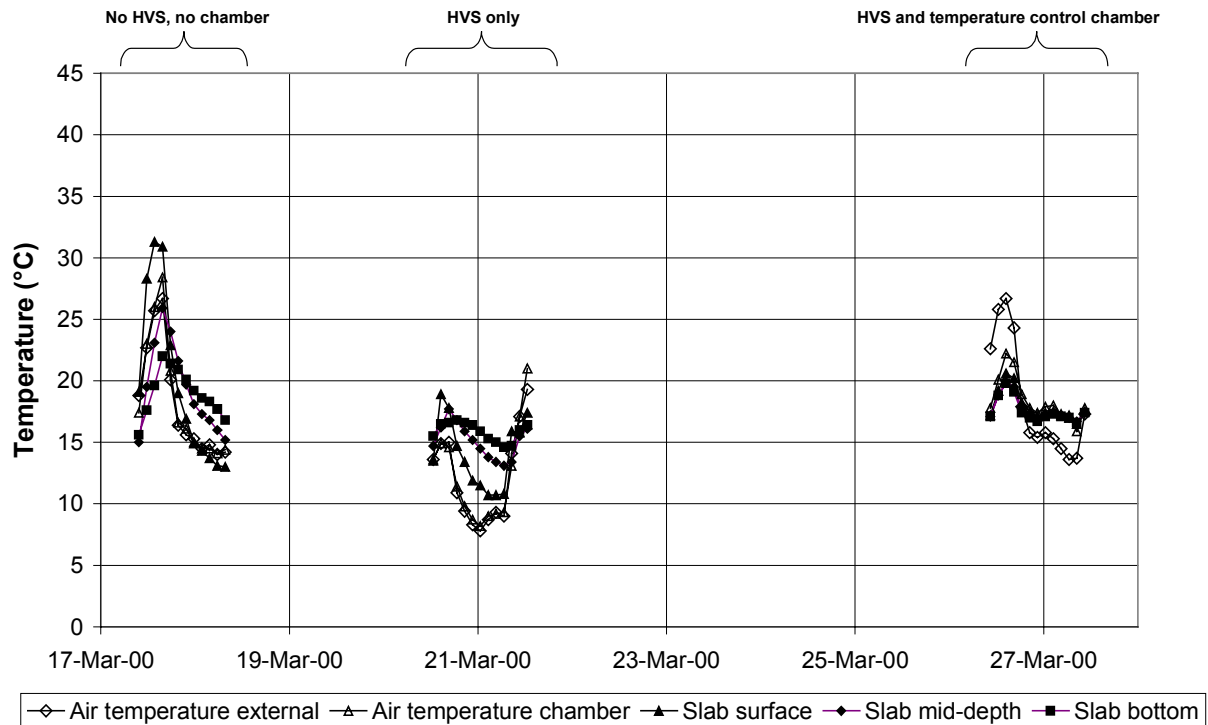

Figure 5.2b. Section 535FD selected temperature measurements.

Figure 5.2. Section 535FD test history.

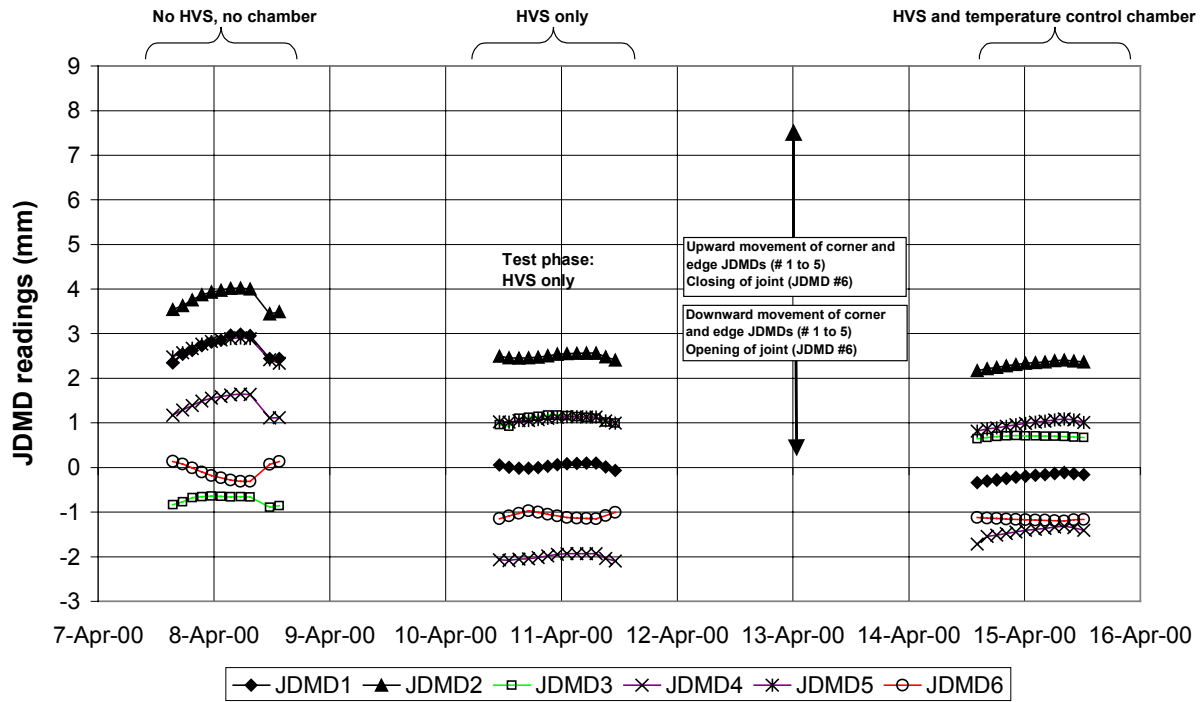

Figure 5.3a. Section 536FD JDMD responses—raw data.

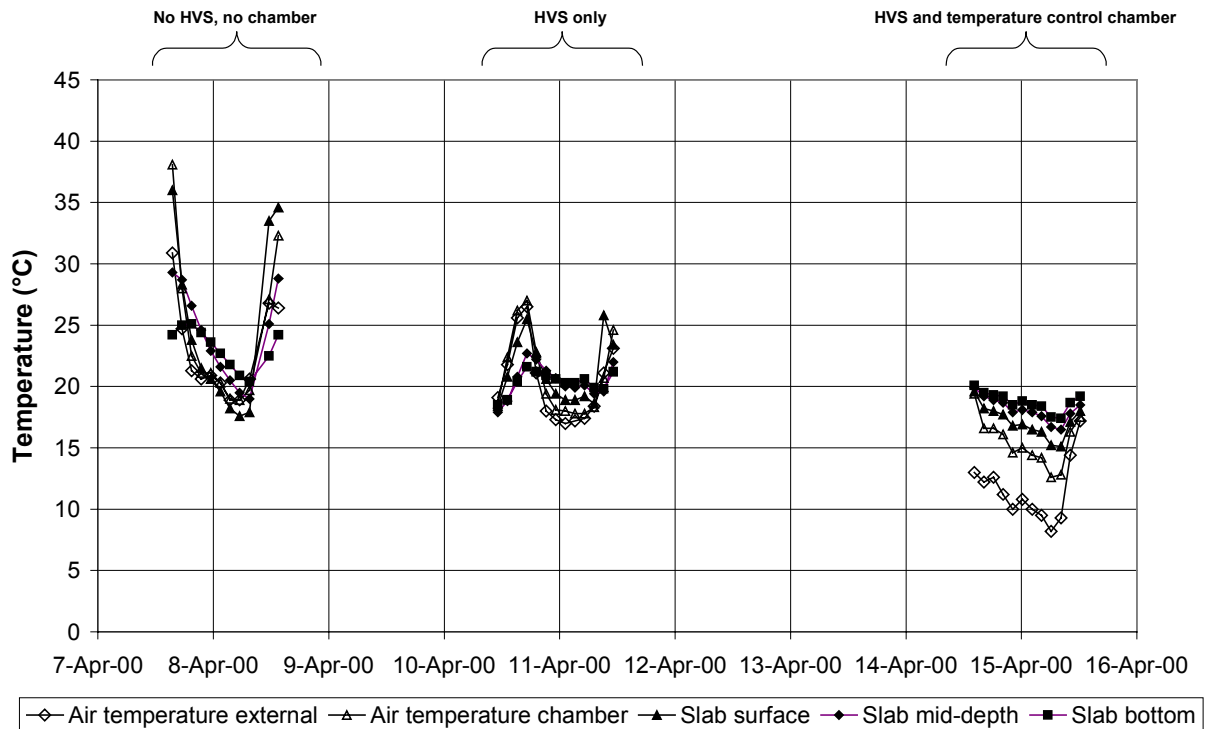

Figure 5.3b. Section 536FD selected temperature measurements.

Figure 5.3. Section 536FD test history.

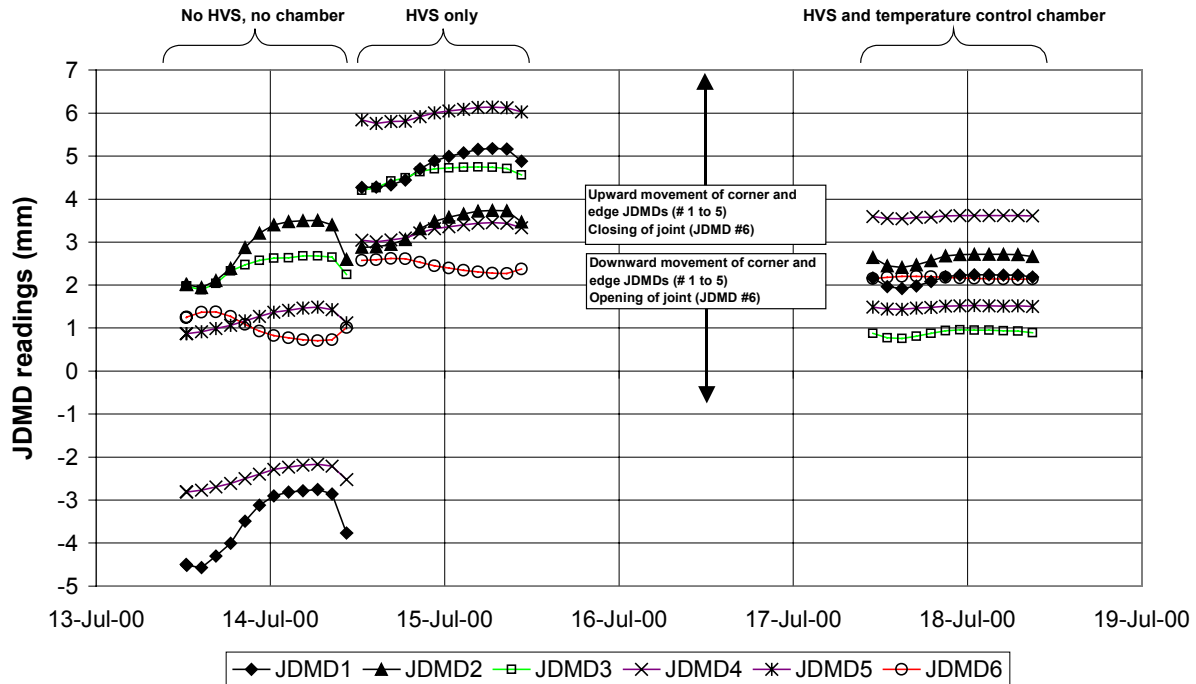

Figure 5.4a. Section 537FD JDMD responses—raw data.

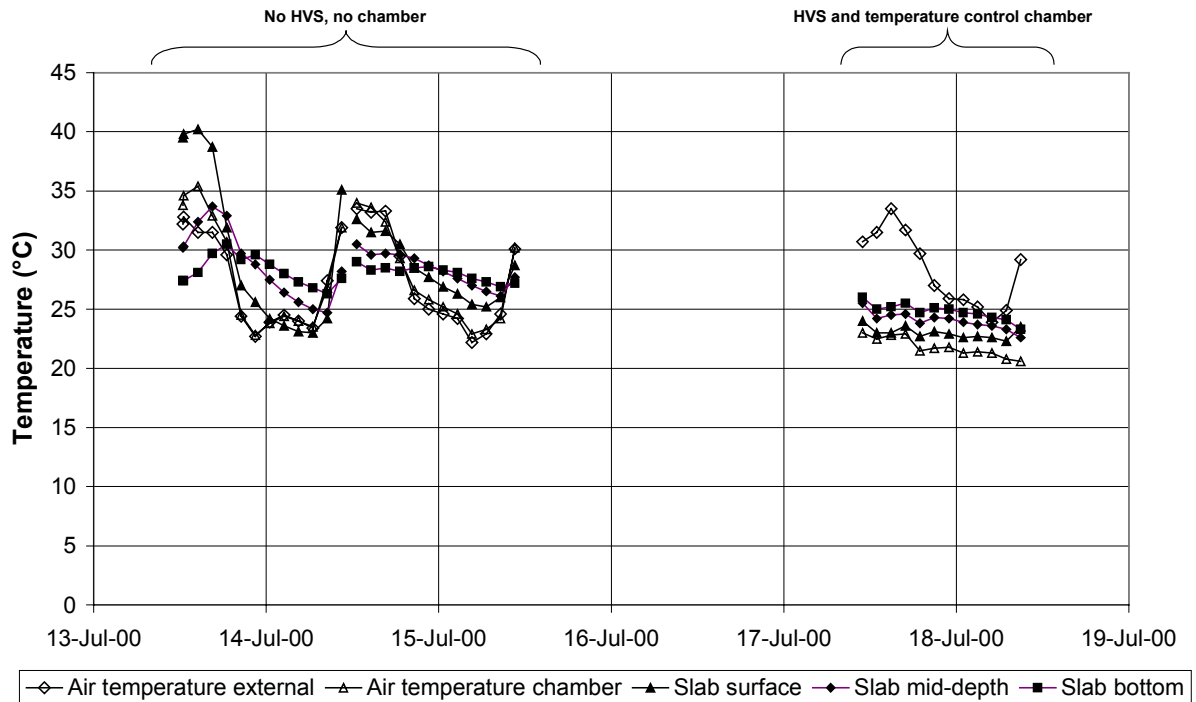

Figure 5.4b. Section 537FD selected temperature measurements.

Figure 5.4. Section 537FD test history.

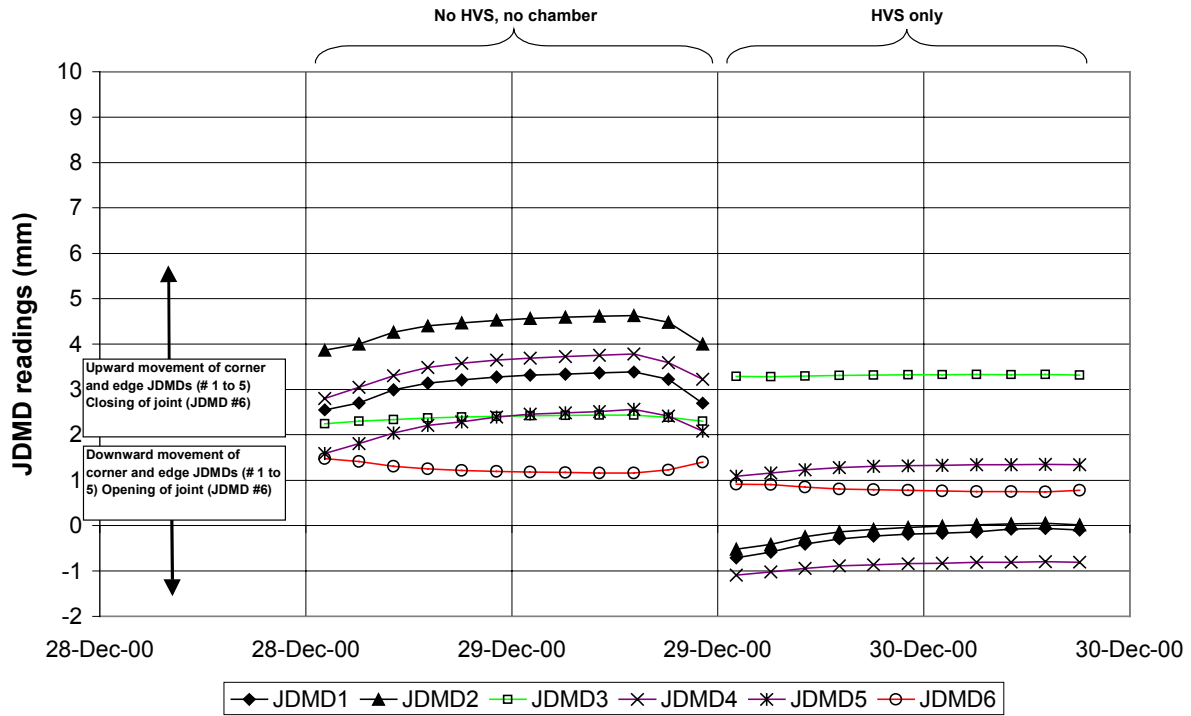

Figure 5.5a. Section 538FD JDMD responses—raw data.

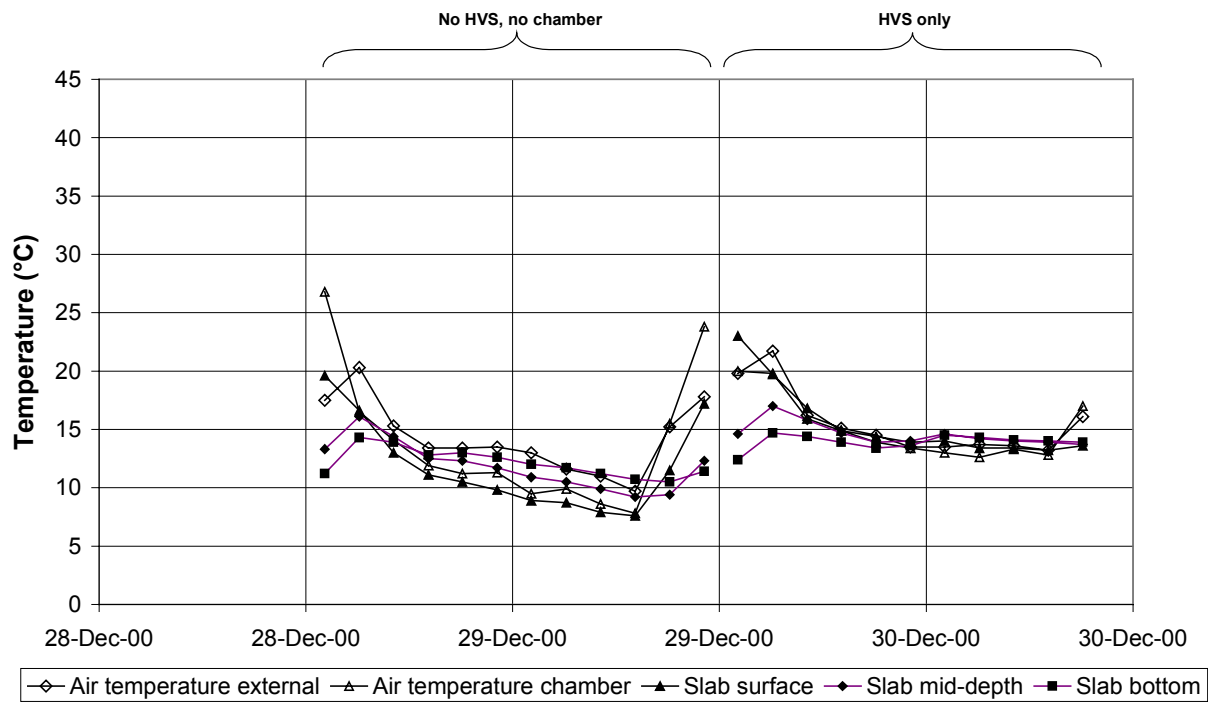

Figure 5.5b. Section 538FD selected temperature measurements.

Figure 5.5. Section 538FD test history.

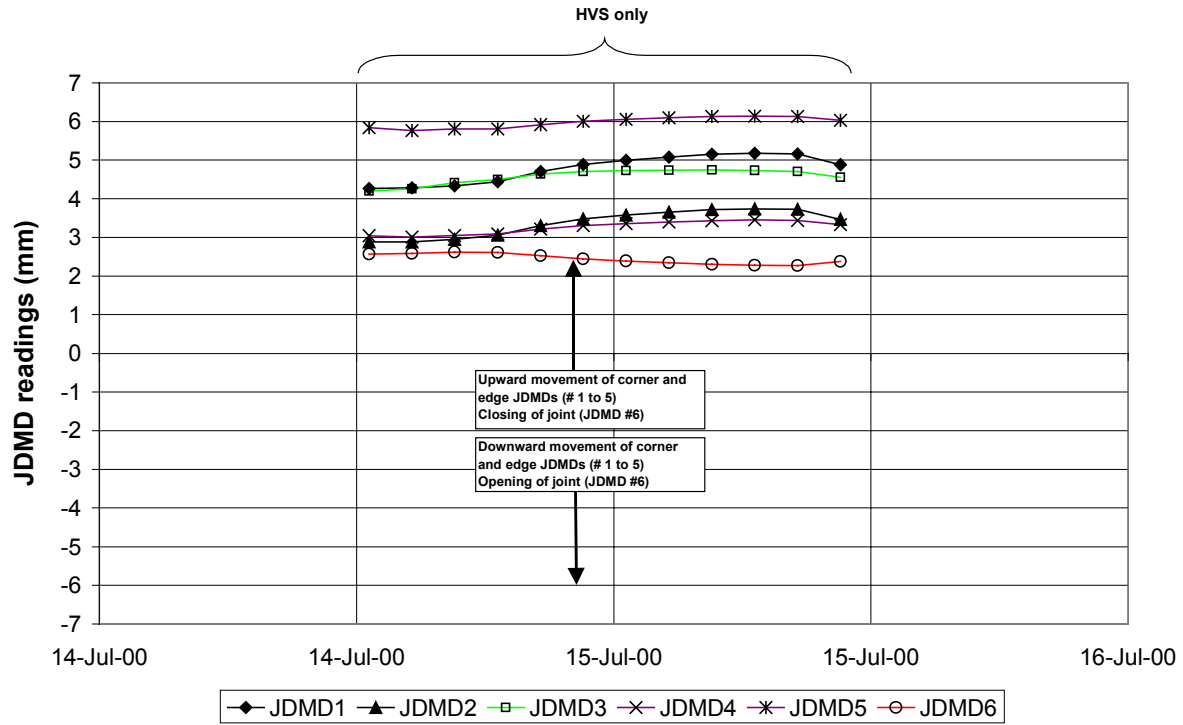

Figure 5.6a. Section 539FD JDMD responses—raw data.

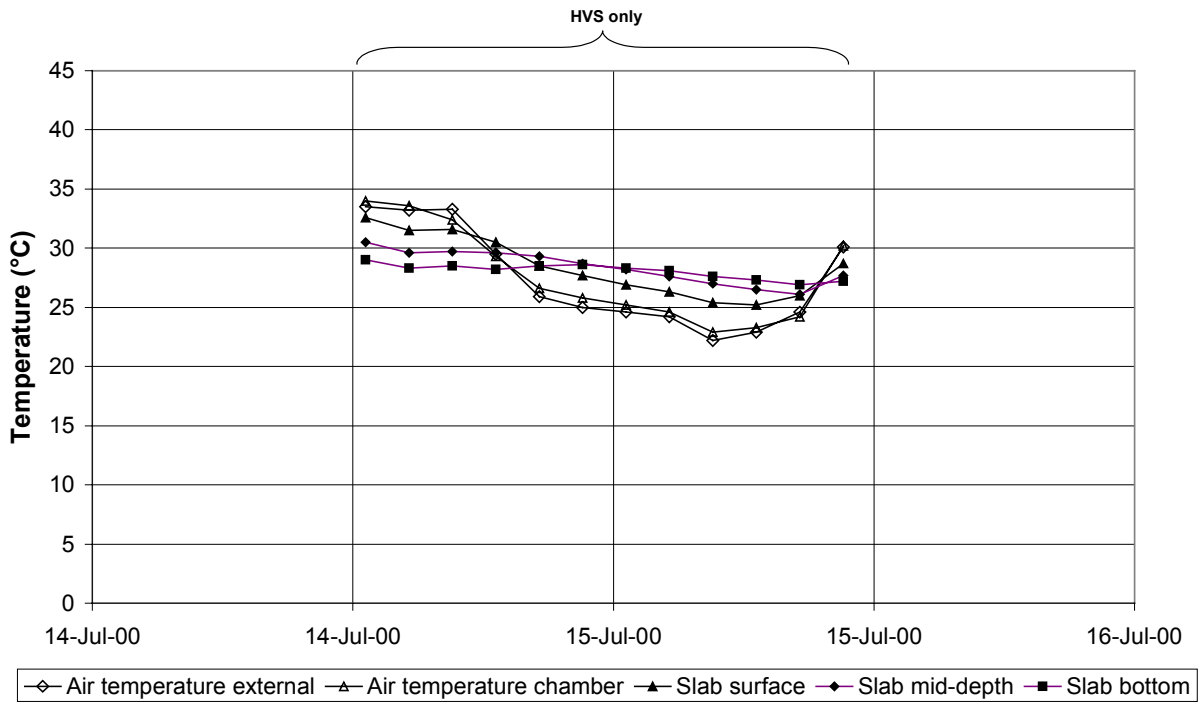

Figure 5.6b. Section 539FD selected temperature measurements.

Figure 5.6. Section 539FD test history (first test phase).

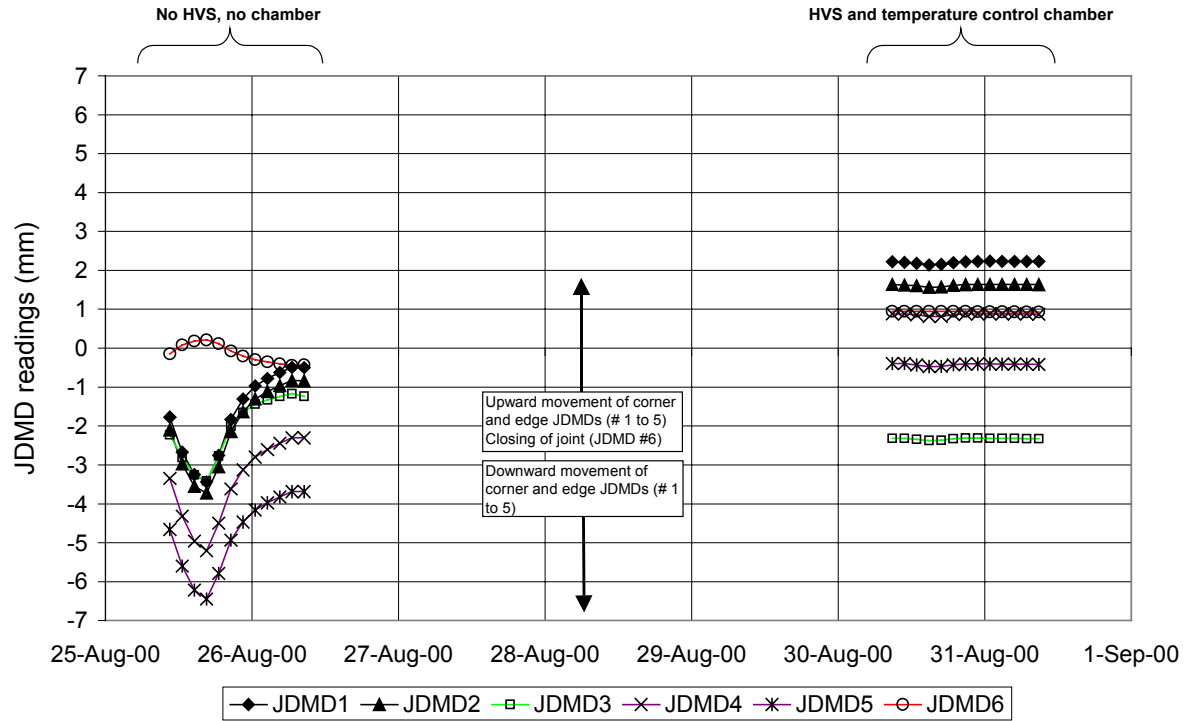

Figure 5.7a. Section 539FD JDMD responses—raw data.

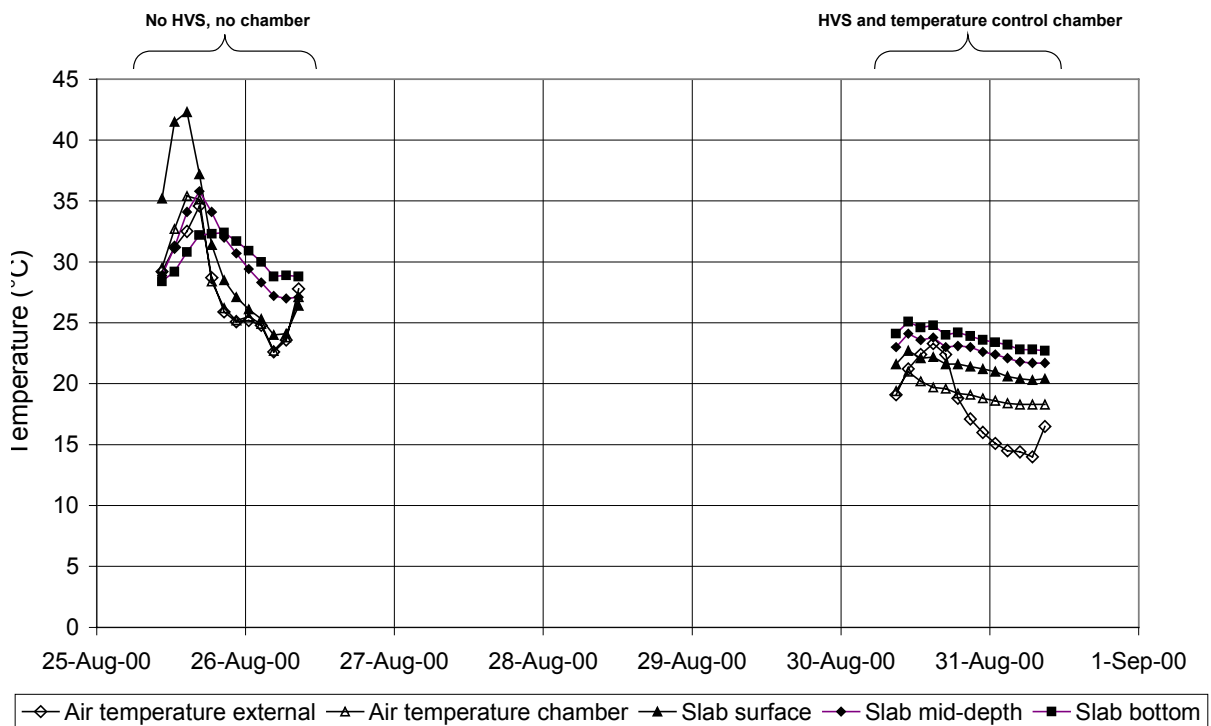

Figure 5.7b. Section 539FD selected temperature measurements.

Figure 5.7. Section 539FD test history (second and third test phases).

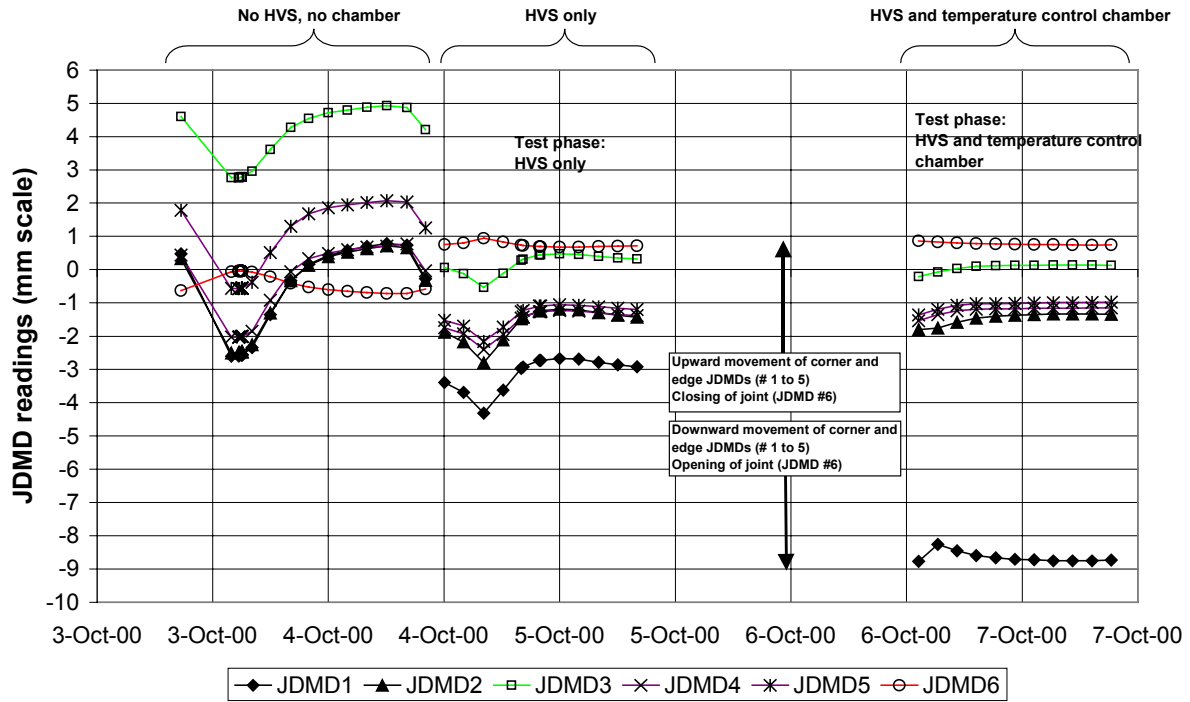

Figure 5.8a. Section 540FD JDMD responses—raw data.

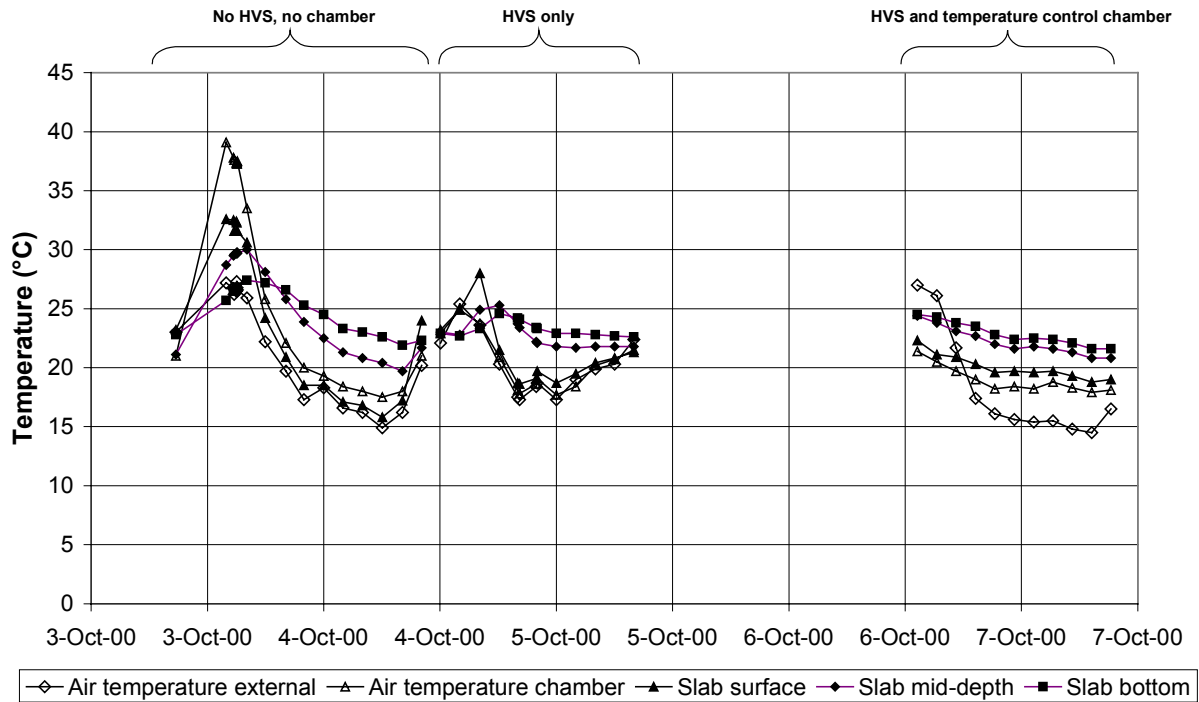

Figure 5.8b. Section 540FD selected temperature measurements.

Figure 5.8. Section 540FD test history.

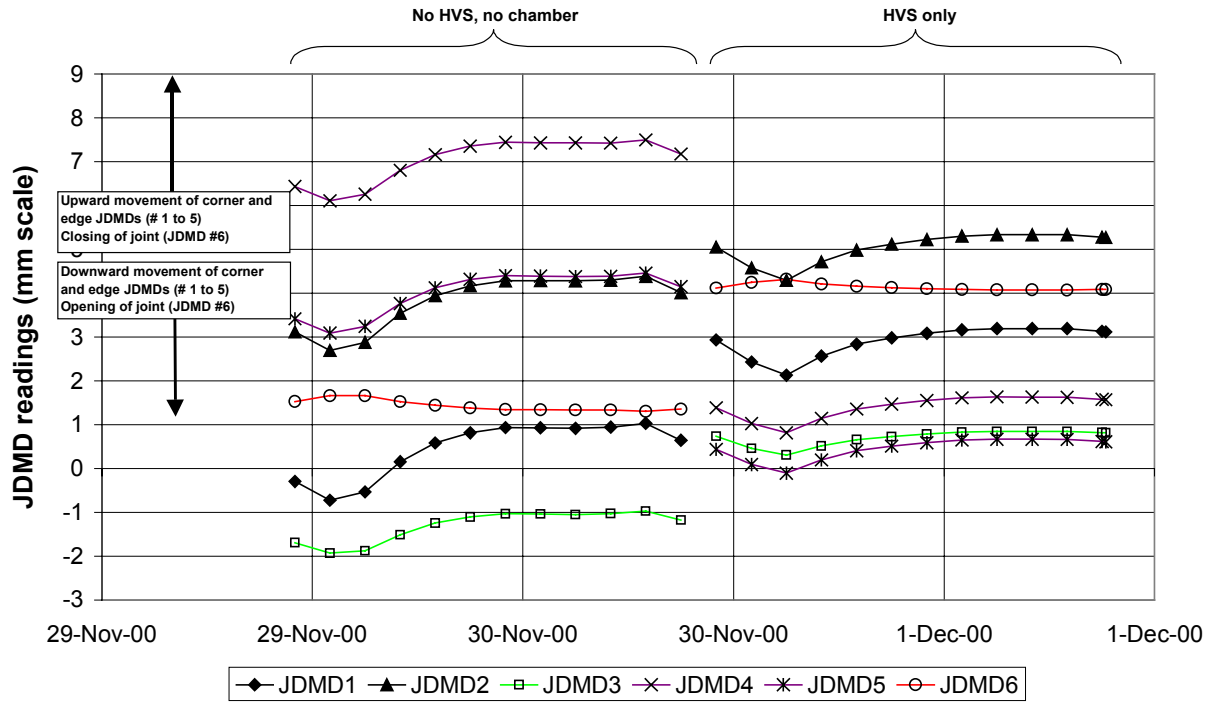

Figure 5.9a. Section 541FD JDMD responses—raw data.

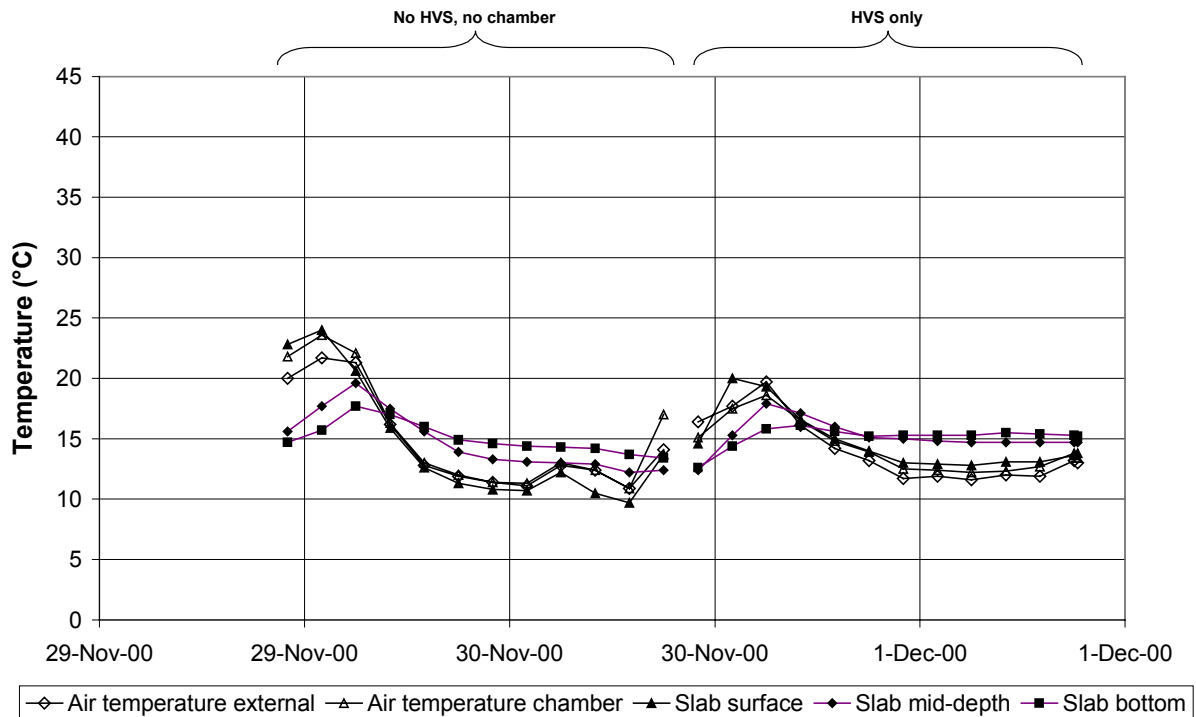

Figure 5.9b. Section 541FD selected temperature measurements.

Figure 5.9. Section 541FD test history.

5.4, respectively), this leads to marked bunching of the data in the figure, it is regarded as justified because it allows direct comparison while remaining sufficiently clear to identify the principle behavioral trends. For Test 540FD, in which measurements spanned one and a half months and the data bunching is too pronounced to allow visual assessment on a single time scale, the data are given in two parts (Figures 5.6 and 5.7).

The raw JDMD readings shown in the upper graph are not comparable among Figures in absolute terms because the initial readings are arbitrary. However, the vertical scales (y-axes) have generally been set to similar ranges for review. The temperature scale of the lower graph is directly comparable among figures.

General observations on the slab behavior from these figures include the following:

- The slab movements are clearly temperature related.
- The most significant movements occur at or near the corners. Edge movements and joint movements are progressively lower in magnitude.
- Temperature increases lead to downward movement at slab corners and edges and closing of joints.
- Measured temperature profiles indicate some phase differences between occurrences of maxima and minima.
- Good correspondence seems to exist between slab corner movements on each side of joints (JDMD pairs 1 and 2, and 4 and 5).
- Slab movement appears most closely correlated with slab surface temperature.

It should be noted that these general observations are expected and confirm that the instrumentation was properly functioning, with the exception of JDMD 1 during the last phase of Test 540FD (with the HVS and temperature control chamber in position) (Figure 5.8). The anomalous readings from JDMD 1 on Section 540FD indicate an initially relatively large upward movement (just over 0.5 mm compared with less than 0.2 mm for the other corner movements), and then an apparent downward movement for the rest of the test whereas all other corner movements continued upward as the temperature decreased throughout.

Neither JDMD 2 (monitoring the directly comparable movement on the adjacent slab corner across the joint) nor any of the other movement measurements indicate unexpected behavior, so it can reasonably be assumed to be an instrumentation problem. In any case, given the absence of any evidence regarding possible localized cracking or other discontinuity, further discussion of this apparently anomalous result is unwarranted.

It should be further noted that the JDMD measurement values (absolute readings) should not be regarded as directly comparable among test phases, even though in some cases this appears reasonable. A preliminary comprehensive evaluation of the raw data for each test clearly shows that generally there are shifts between sets of readings for individual JDMDs in the different phases. These are likely to be attributable to both non-quantifiable physical and instrumentation factors, which therefore dictate that the test phase results are evaluated individually.

5.2 Temperature-induced Movements on the Test Sections

Figures 5.10 to 5.17 give the movements measured by the six JDMDs on each test section and for each phase of the test. In line with the discussion in Section 5.1, the movements with respect to measured temperature on the surface of the test section are given in a relative manner

to allow comparison of the responses. Thus, the raw JDMD data have been processed for each measurement set such that the recorded movements are referred to either the maximum reading (for the responses that decrease with temperature increase, JDMDs 1 to 5 inclusive) or the minimum (for the response that increases with temperature increase, JDMD 6). These reference points have been assigned whole number (mm) values and are separated by 2-mm steps. As will be noted in Figures 5.10 to 5.17, this processing simply separates the measured responses on the vertical axis (on which each horizontal gridline represents one millimeter) while maintaining the form of temperature-induced behavior.

Further, it should be noted that because this processing is applied to each separate data set from each phase of testing, for every JDMD there are either two or three data groups on each figure that have the same maximum/minimum vertical reference point, but at different temperature values. Some additional processing or further arbitrary translation may be justified to align the data sets better, but this additional data manipulation will add little or nothing to interpretation or quantification. The measurements from different phases of the test use different connecting lines to the data points (solid for the first test phase, dotted for the second, and dashed for the third if applicable). These connecting lines show the trends in movement related to temperature.

The effect of the different slab designs in influencing thermal movements can be identified reasonably well from these figures. The following discussion provides specific observations.

5.2.1 Design Section 7: No Dowels, Asphalt Shoulder (Tests 534FD and 535FD)

The results of the tests on Design Section 7 are presented in Figures 5.10 and 5.11. The range of pavement surface temperatures during these tests was from just over 10°C to just over

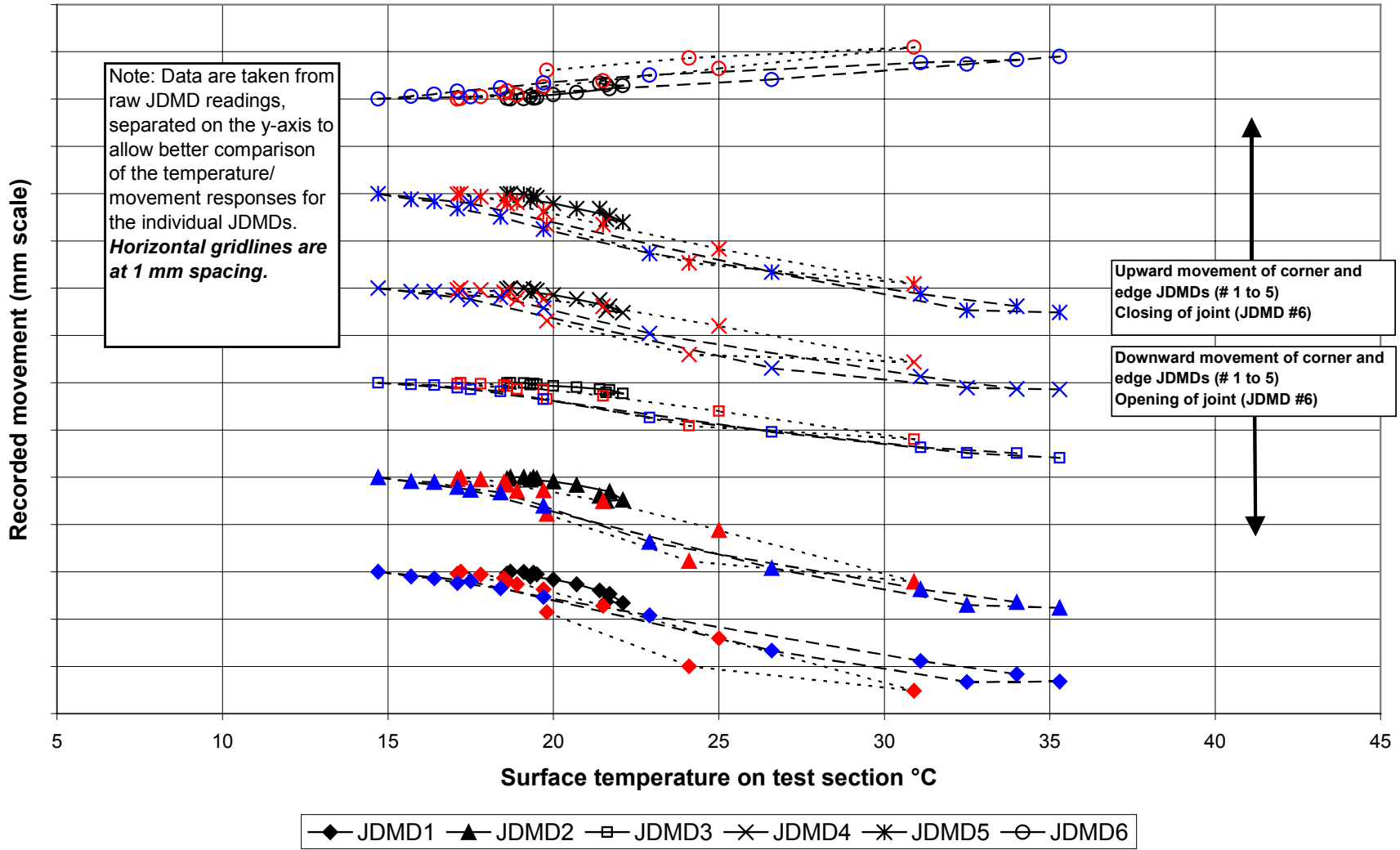

Figure 5.10. Section 534FD JDMD responses to surface temperature (Section 7: no dowels, asphalt shoulder).

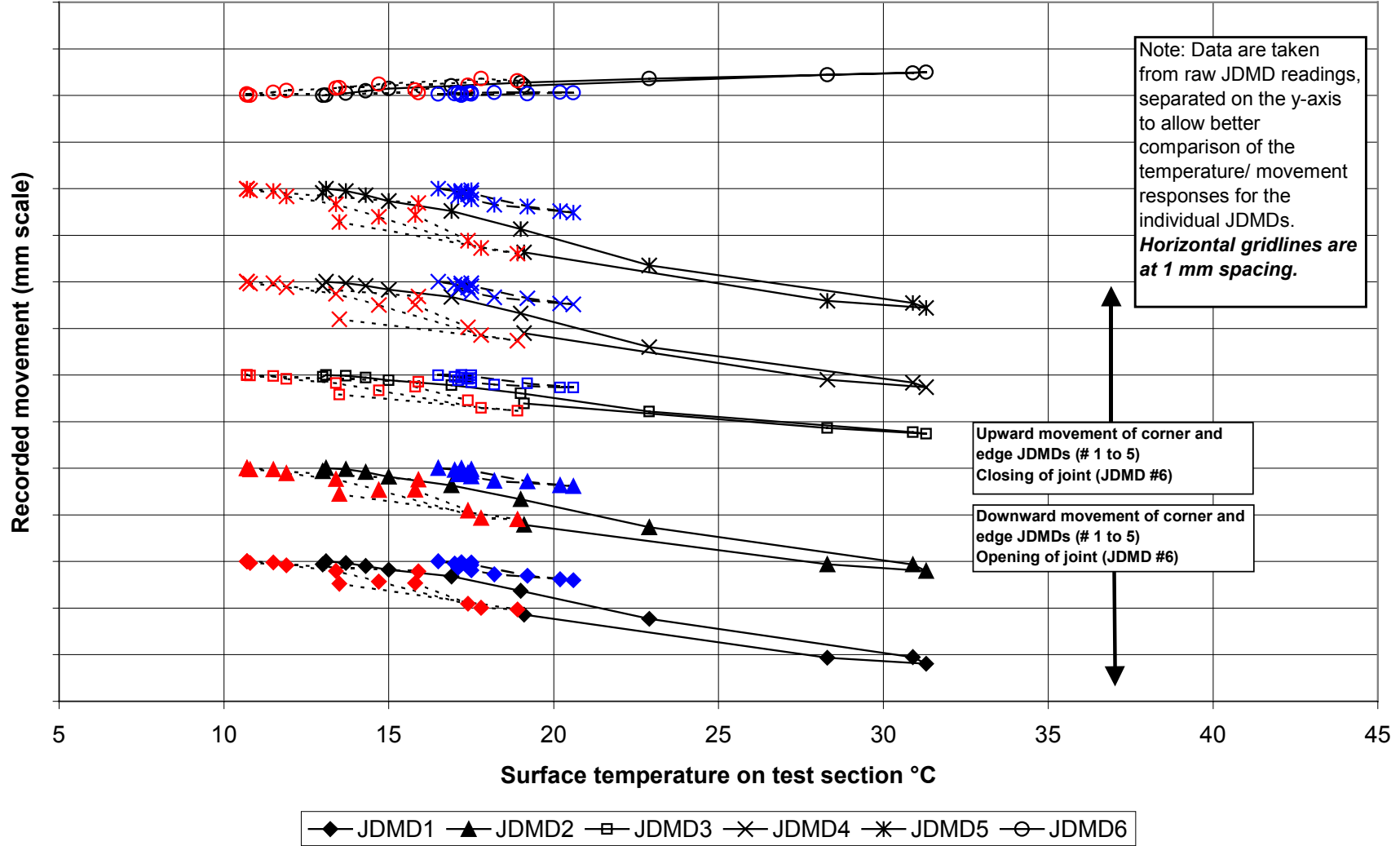

Figure 5.11. Section 535FD JDMD responses to surface temperature (Section 7: no dowels, asphalt shoulder).

35°C, with a range of about 20°C for each test. The vertical responses (corners and edge: JDMDs 1 to 5) in both cases indicate a distinct change in rate of movement above and below approximately 20°C.

Up to 20°C, the rate of corner downward movement is approximately 0.5 mm/10°C (within the test temperature range). Above 20°C, this increases to about 1.5 mm/10°C (test 534FD was measured to have a slightly greater rate than 535FD). There is also some indication of a decrease in the rate of movement at temperatures above 30°C.

The edge movement (JDMD 3) follows a similar pattern but with smaller overall movement. However, the initial rate of movement to 20°C is effectively the same as for the corner movements, then decreasing to roughly the order of half of that for the corners (0.8 mm/10°C).

Joint closing (JDMD 6) does not exhibit any distinct change in rate of movement at a particular temperature, and is notably linear in response. However, there is a significant difference in the nominal rates for the two test cases: approximately 0.5 mm/10°C for 534FD and only about half that for 535FD.

5.2.2 Design Section 9: dowels, tied concrete shoulder (Tests 536FD to 538FD)

The results from the tests on Design Section 9 are presented in Figures 5.12 to 5.14. Compared with the other tests, Section 9 showed much less scattered response overall. The range of pavement surface temperatures during these tests was from approximately 7°C to just over 40°C, with a range of about 15 to 20°C for each test. The vertical responses (corners and edge: JDMDs 1 to 5) show a distinctly lower rate of movement than those of the previous section, presumably mainly attributable to the restraining effects of the tied concrete shoulder and also the inclusion of dowels. Overall, the responses are linear for practical purposes

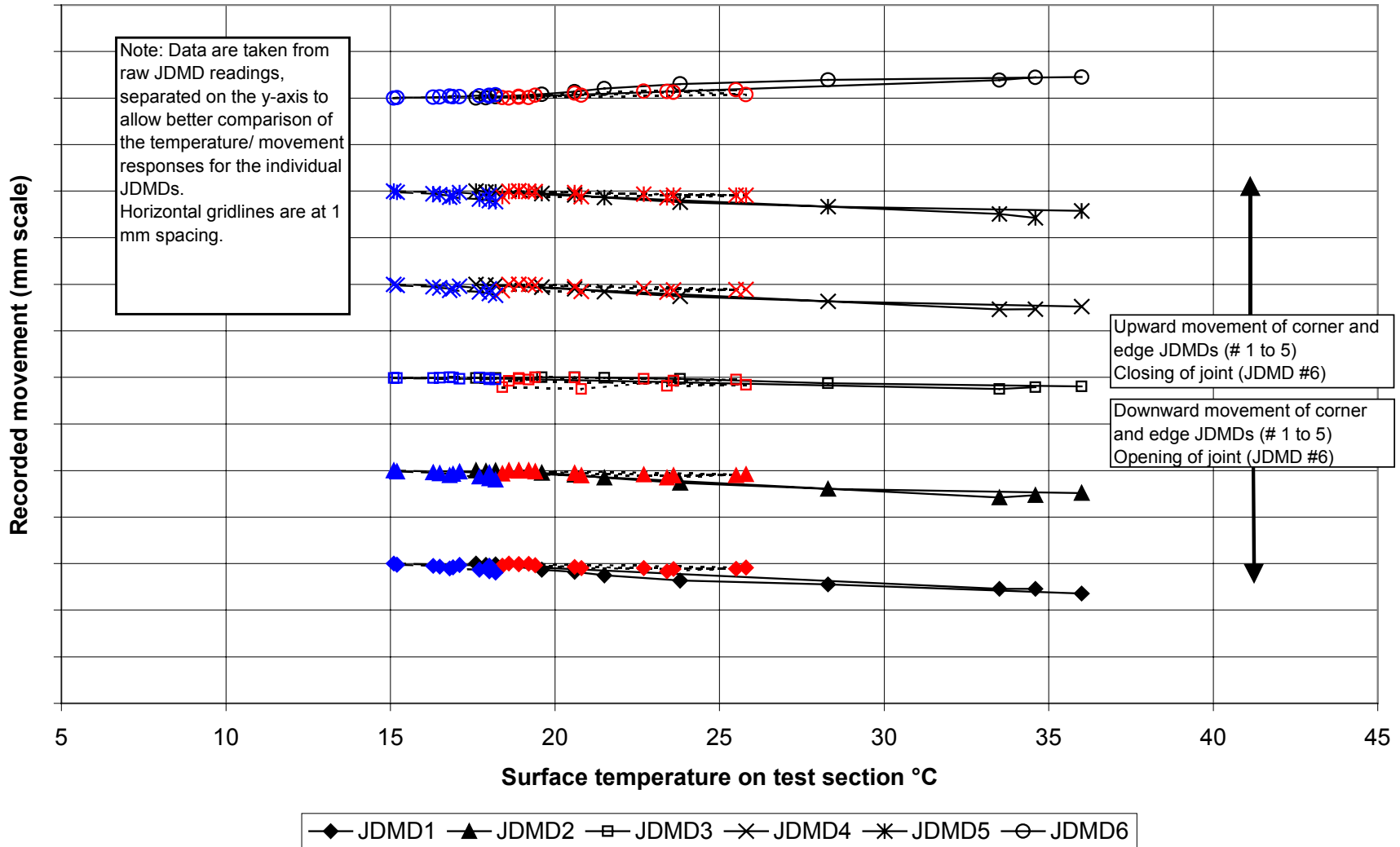

Figure 5.12. Section 536FD JDMD responses to surface temperature (Section 9: dowels, tied concrete shoulder).

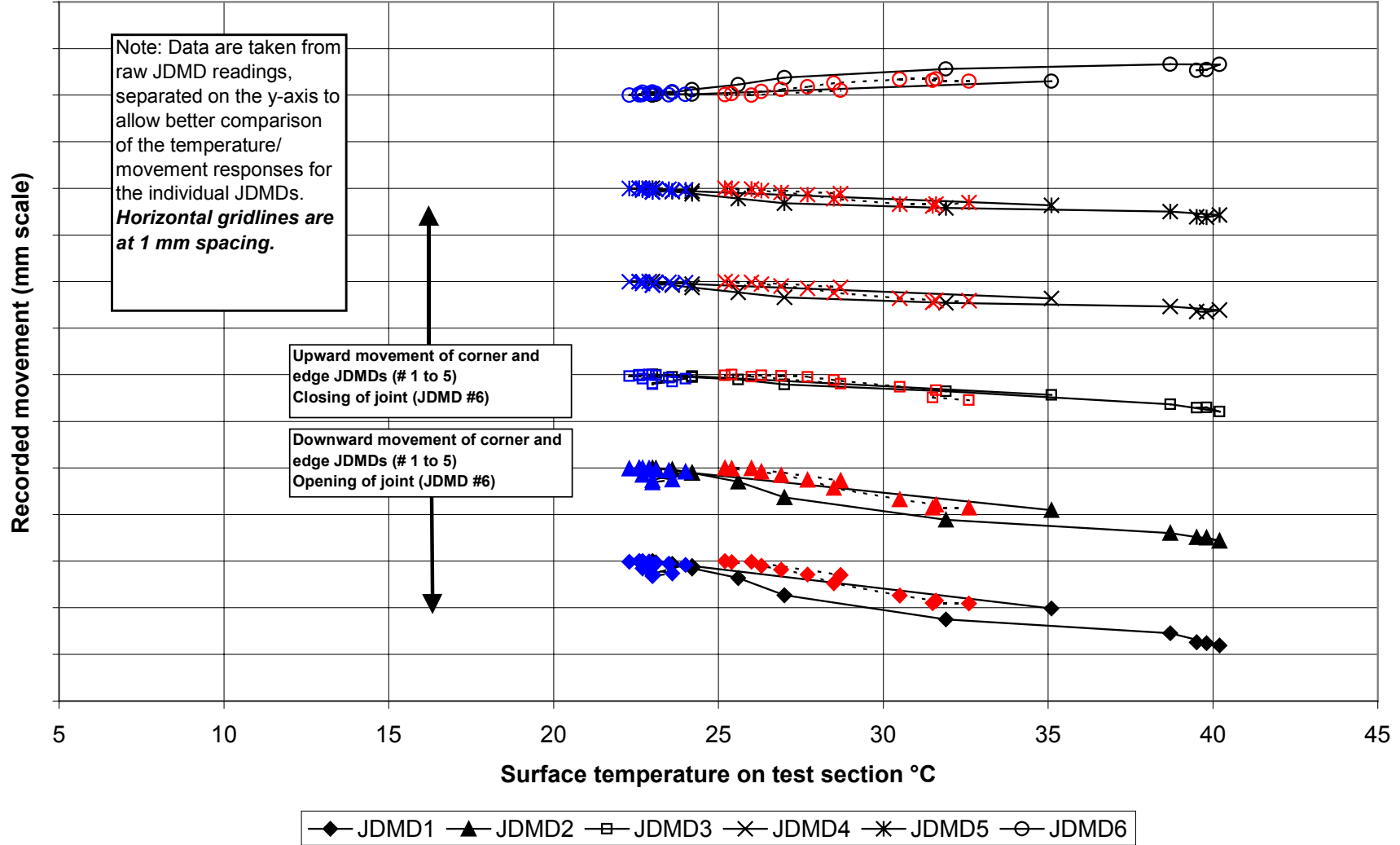

Figure 5.13. Section 537FD JDMD responses to surface temperature (Section 9: dowels, tied concrete shoulder).

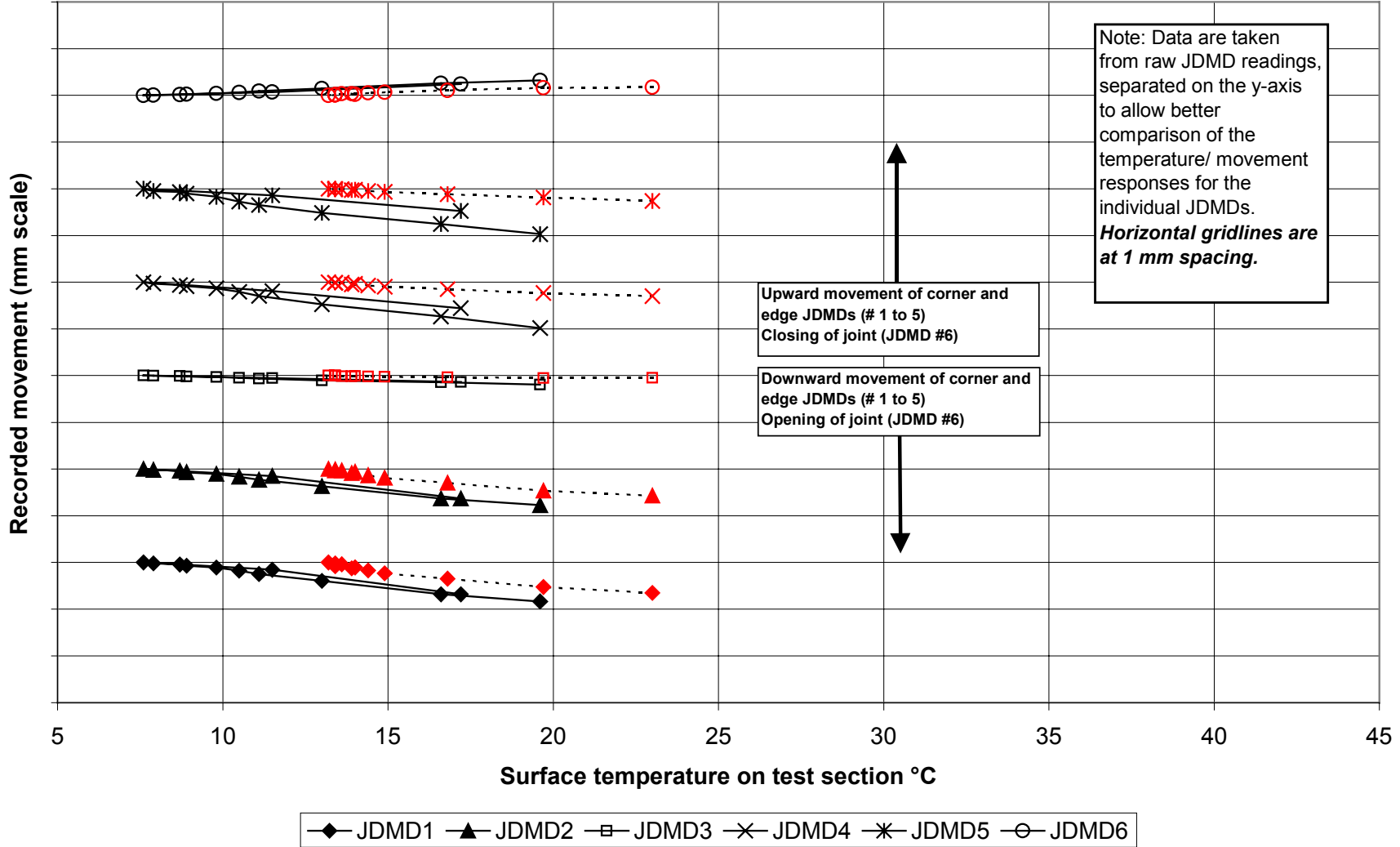

Figure 5.14. Section 538FD JDMD responses to surface temperature (Section 9: dowels, tied concrete shoulder).

throughout, although there is a suggestion of an increase in the rate of movement in Test 537FD as the surface temperature goes above about 25°C and again as the temperature approaches 40°C. The maximum temperature in 538FD was lower than 25°C, so can provide no further insight. Test 536FD gives no clear indication but suggests slightly lower rates of movement after the first phase measurements.

Test 536FD (Figure 5.12) gives the most consistent results overall with only a slight indication of a difference from one test phase to another as just noted. Rates of vertical corner movements were 0.25 to 0.35 mm/10°C, with each JDMD pair on either side of the joints providing very similar results. The measured edge movement was less than 0.1 mm per 10°C (JDMD 3), which is roughly one third of the rate for the corner movements. Although this value is small, it was consistently changing with surface temperature (i.e., no apparent lock-up at the joint). The joint closing rate was also consistent throughout at about 0.25 mm/10°C.

In the case of Test 537FD (Figure 5.13), movements were generally more pronounced than for 536FD. JDMDs 1 and 2 gave a distinctly nonlinear response during part of the first phase testing. This corresponds with the sharp decrease in slab surface temperature from around 40°C to approximately 25°C from late afternoon into the evening, and presumably reflects nonlinear resistance to general contraction and changes in the slab temperature profile. Rates of corner movements therefore range from about 0.35 mm/10°C for JDMDs 4 and 5, to about 0.9 mm/10°C for JDMDs 1 and 2, with each JDMD pair on either side of the joints giving very similar results. The measured edge movement was about 0.35 mm per 10°C (JDMD 3), which although similar to the rate for JDMDs 4 and 5, will more likely be derived from the responses of both corners among other factors. The joint closing rate was fairly consistent throughout the test at about 0.35 mm/10°C.

The results for Test 538FD (Figure 5.14), which was undertaken in the lowest temperature range of all the tests during late December, tend to lie somewhere between the previous tests in terms of rates of vertical movements at corners and edge. Typical ranges are 0.25 mm/10°C for edge movement, 0.6 mm/10°C for JDMDs 1 and 2, and from 0.3 to 0.8 mm/10°C for JDMDs 4 and 5. In this latter case, there were marked differences in the responses during phase 1 and phase 2, with the first phase movements giving the higher rates. This was without the HVS, whereas the second phase had the HVS standing across the test section, so it may be conceivable that this provided additional local constraint across the specific joint. The other JDMD corner and joint measurements are for the other joint, and these showed no obvious differences between test phases. The edge movement was also unaffected.

5.2.3 Design Section 11: Dowels, Asphalt Shoulder, Wider Slab (Tests 539FD to 541FD)

The results from the tests on Design Section 11 are presented in Figures 5.15 to 5.17. Compared with the other tests, Design Section 11 shows the most non-linear responses overall. The range of pavement surface temperatures during these tests was from just below 10 to just about 43°C, with a range of about 15 to 20°C for each test.

The non-linearity is seen in the vertical responses (corners and edge: JDMDs 1 to 5) of at least one phase and is most pronounced in the cycles reaching the highest temperatures. A particular contributing factor could be closing of the joints during testing, however, this is not indicated from the results. Consistent rates of movement at the joint range from 0.2 to 0.4 mm/10°C.

The non-linear responses take the form of both different nominal rates of movement at lower and higher temperatures, and a hysteresis-type response clearer during higher temperature cycles. The temperature regimes during the tests were predominantly decreasing. So for

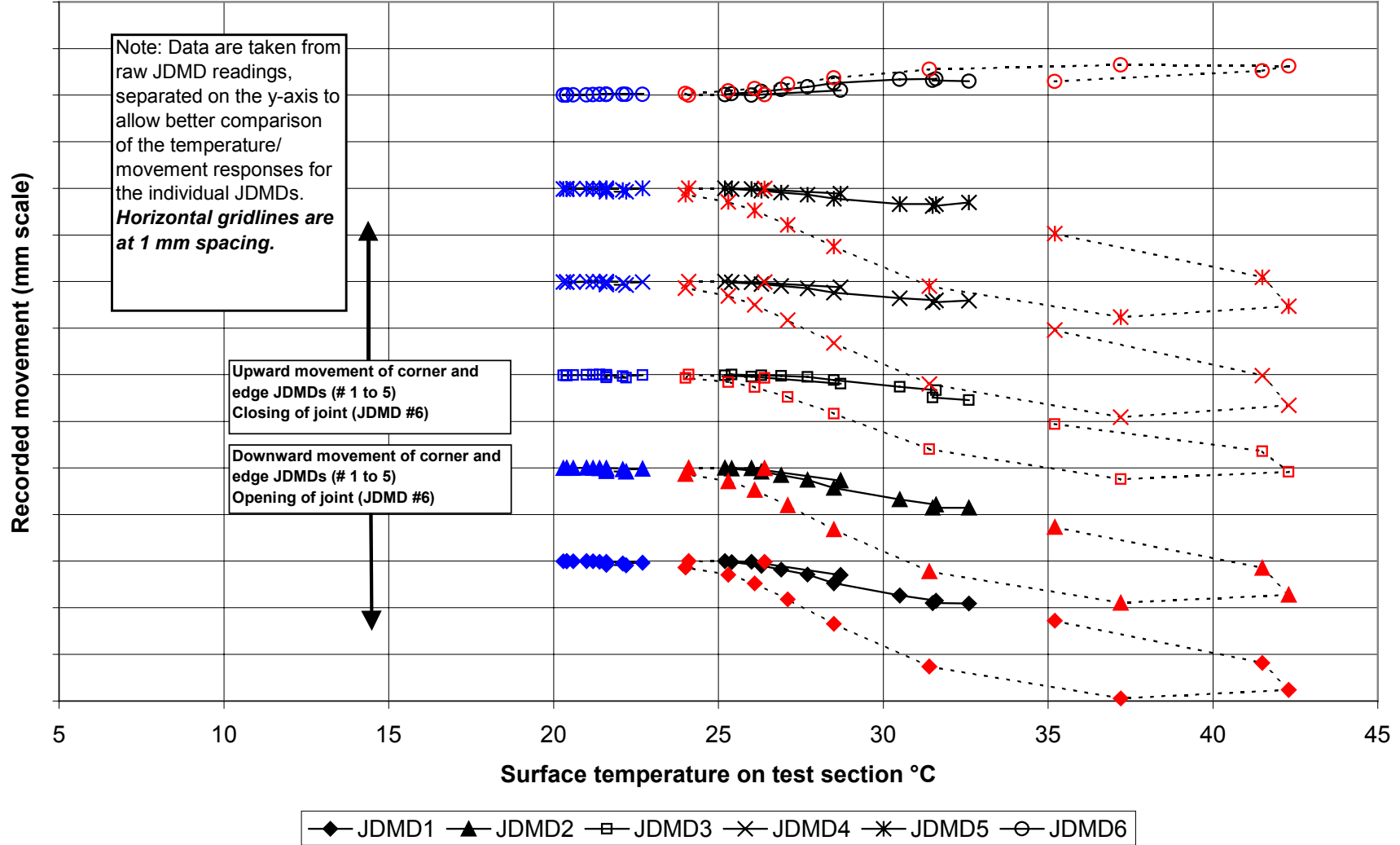

Figure 5.15. Section 539FD JDMD responses to surface temperature (Section 11: dowels, asphalt shoulder, 4.3-m wide lane).

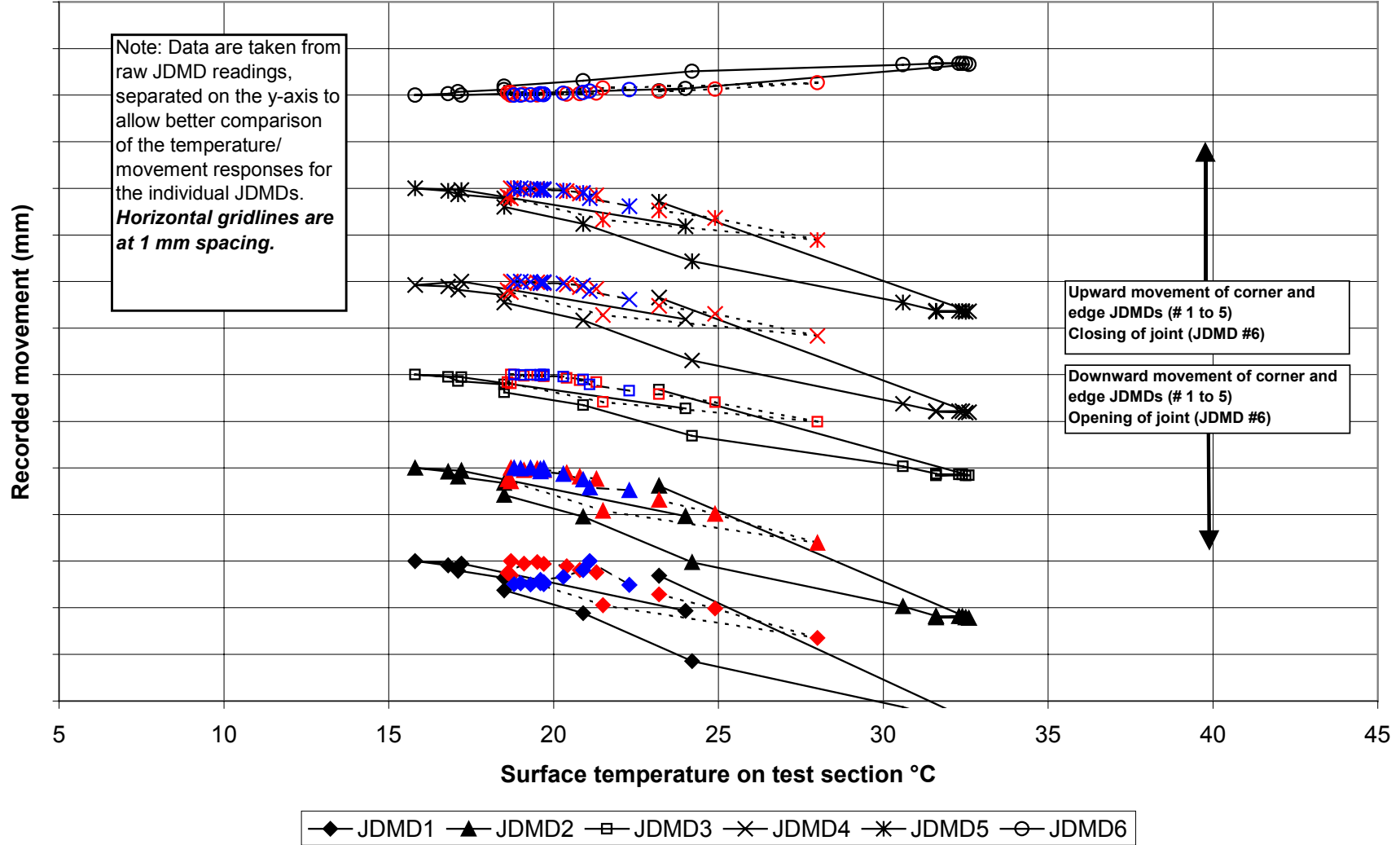

Figure 5.16: Section 540FD JDMD responses to surface temperature (Section 11: dowels, asphalt shoulder, 4.3-m wide lane).

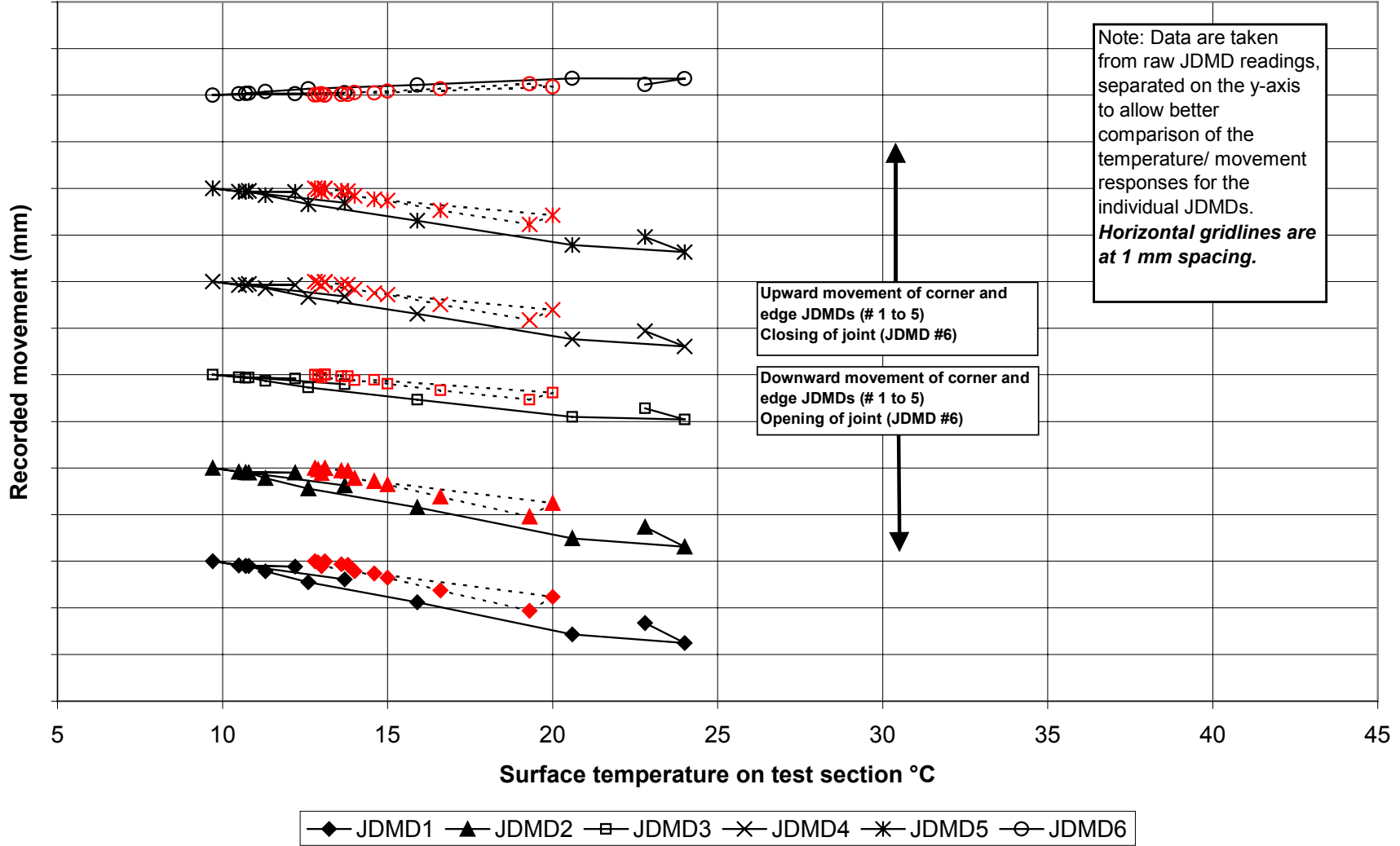

Figure 5.17. Section 541FD JDMD responses to surface temperature (Section 11: dowels, asphalt shoulder, 4.3-m wide lane).

example, although it appears in Test 539FD that the response during the first phase testing (solid line) follows the same path as the upper part of the response during the second phase (dotted line) for the vertical movements (JDMDs 1 to 5), the first phase response was to falling temperatures whereas in the second phase, the response was to rising temperatures. The falling temperature response during the second phase is actually the lower side of the curve.

In this case, the observed behavior may suggest that the non-linear hysteresis-type response becomes evident only at higher temperatures (up to 43°C in the second phase of this test). This, however, is clearly refuted by the other two test series (540FD and 541FD) in which similar responses are seen with far lower maximum temperatures (roughly 24 and 33°C).

It is clear that the hysteresis-type response is caused by a combination of factors that contribute to the complex upward and downward movements and the general contraction and expansion of the concrete slabs. The most distinct hysteresis-type response is seen on Test 539FD, which had the highest joint movement rate. The least distinct hysteresis-type response is seen on Test 541FD, which had the lowest joint movement rate among the tests on Design Section 11 (dowels, asphalt shoulder, 4.3 m wide). Overall, the joint movement rates on Design Section 11 were slightly lower than for Design Section 7 (no dowels, asphalt shoulder, 3.6 m wide) and yet the hysteresis-type effect was less apparent during that test series.

It might therefore be surmised that the plastic resistance to returning to position under decreasing temperatures in this case was also partly attributable to the wider slab and dowels, as well as the in-slab temperature regime.

5.2.4 Summary

The comparison of temperature-influenced movements on the three design sections shows that the highest restraint to movement occurs, predictably, in the doweled slabs with the

tied concrete shoulder (Design Section 9, Tests 536FD, 537FD, and 538FD). Table 5.1 summarizes the nominal rates of vertical and joint movements for all three design sections evaluated.

Probably because of the greater restraint on Design Section 9, the responses on all three tests were nearly linear throughout. In contrast, the behavior of the other two design sections [Design Section 7 (no dowels, asphalt shoulder) and Design Section 11 (dowels, asphalt shoulder, 4.3-m wide slab)] was typified by ostensibly non-linear responses made up from nominally two different linear rates and a hysteresis-type response on expansion and contraction.

This behavior was most marked for Design Section 11. While not specifically part of the preceding discussion, it should be noted that reappraisal of the responses on Design Section 7 (Tests 534FD and 535FD) also suggests this type of behavior, although much less pronounced.

Table 5.1 Comparison of Nominal Rates of Movement (mm per 10°C) Based on Surface Temperatures

Movement Type	Rate of Movement (mm per 10°C) Based on Surface Temperatures		
	Design Section 7	Design Section 9	Design Section 11
Vertical – corner	0.5 mm (to 20°C) 1.5 mm (above 20°C)	Typically 0.30–0.60 mm	Typically more than 1 mm and up to 3 mm
Vertical – edge	0.5 mm (to 20°C) 0.8 mm (above 20°C)	Typically 0.10–0.30 mm	Variable, less than corner vertical movement
Joint gap	0.30–0.50 mm	0.10–0.35 mm	0.20–0.40 mm

Design Section 7: no dowels, asphalt shoulder, 3.7 m slab width
 Design Section 9: dowels, tied concrete shoulder, 3.7 m slab width
 Design Section 11: dowels, asphalt shoulder, 4.3 m slab width)

5.3 Transfer of Movements across Joints

Figures 5.18 to 5.20 present the relative movements of the two pairs of JDMDs measuring vertical corner movements on each side of the slab transverse joints for each test case. The readings are the unprocessed raw data from JDMDs 1, 2, 4, and 5 on each test (refer to Figure 3.1 for a diagram of the orientation of the JDMDs). The raw data have been plotted directly against each other to assess responses on each side of the joints (JDMD pairs 1 and 2, and 4 and 5). The convention adopted is that the JDMD readings from the main slab of the section are plotted on the x-axis, and those for the associated JDMD on the other side of the joint are plotted on the y-axis. As for previous figures, the results from different phases are shown by different line patterns: solid for the first phase, dotted for the second, and dashed for the third (if applicable). Lines of equality are also included to facilitate comparison.

As would be expected, this comparison indicates that the vertical corner movements across joints are virtually identical. This is likely due to the combination of any load transfer devices present and the fact that adjacent slabs will tend to curl in similar ways subject to some variation in temperature regimes when the HVS is in position.

Design Section 9 (dowels, tied concrete shoulder—Figure 5.19) again shows the most consistent results and it will be noted that the smaller overall movements on this section during the tests can be clearly seen.

While Design Section 11 gave the highest hysteresis-type variation with temperature change (previous section), it actually gives very good correlation of vertical corner movements on adjacent slabs. The exception is the JDMD 1 and 2 comparison on the last phase of Test 540FD (bottom-most response curve, Figure 5.20), for which the JDMD 1 response has previously been identified as unreliable (Section 4.10.2). It will be noted that the range of

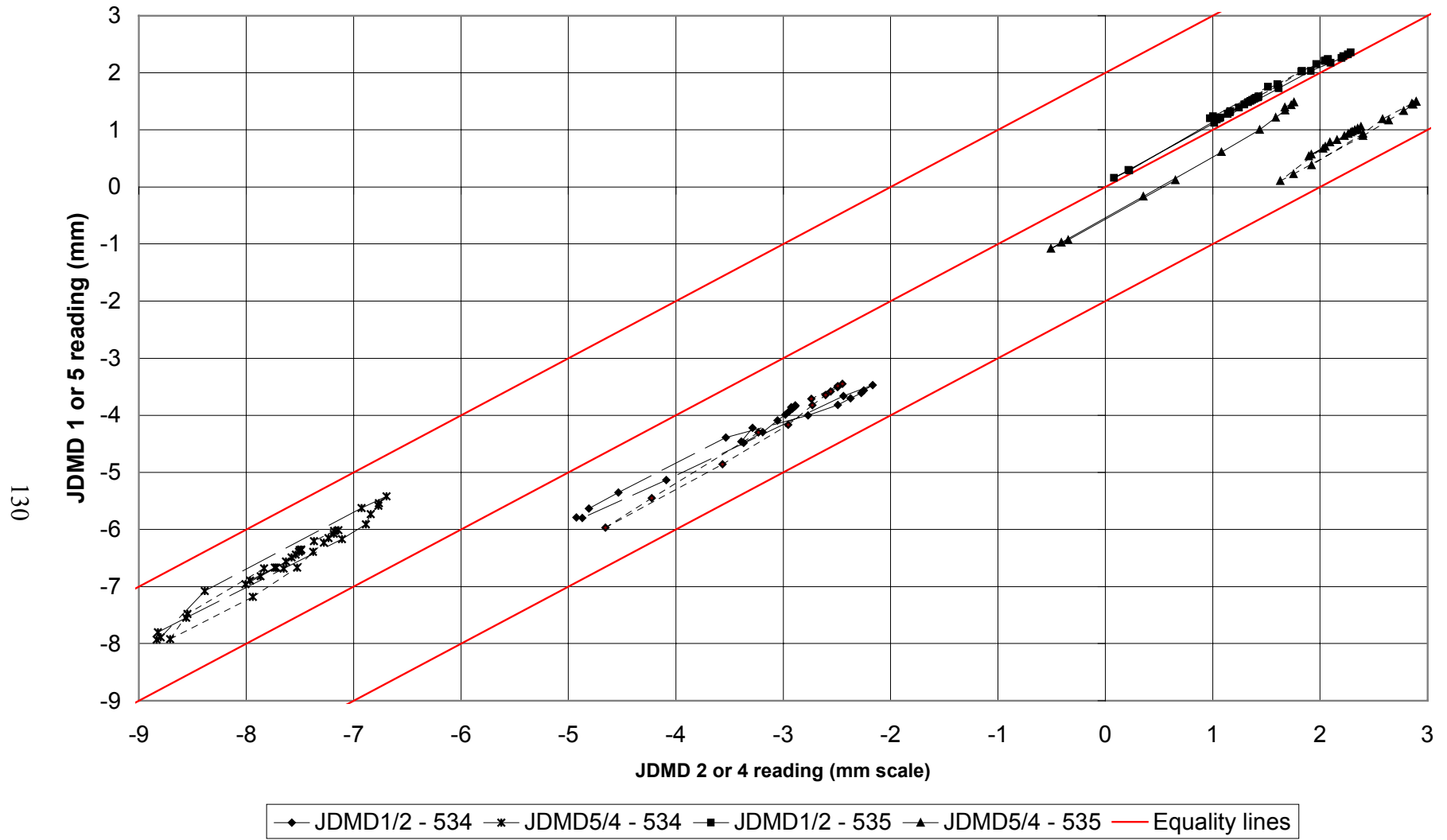

Figure 5.18. Relative movements across the joints for Design Section 7

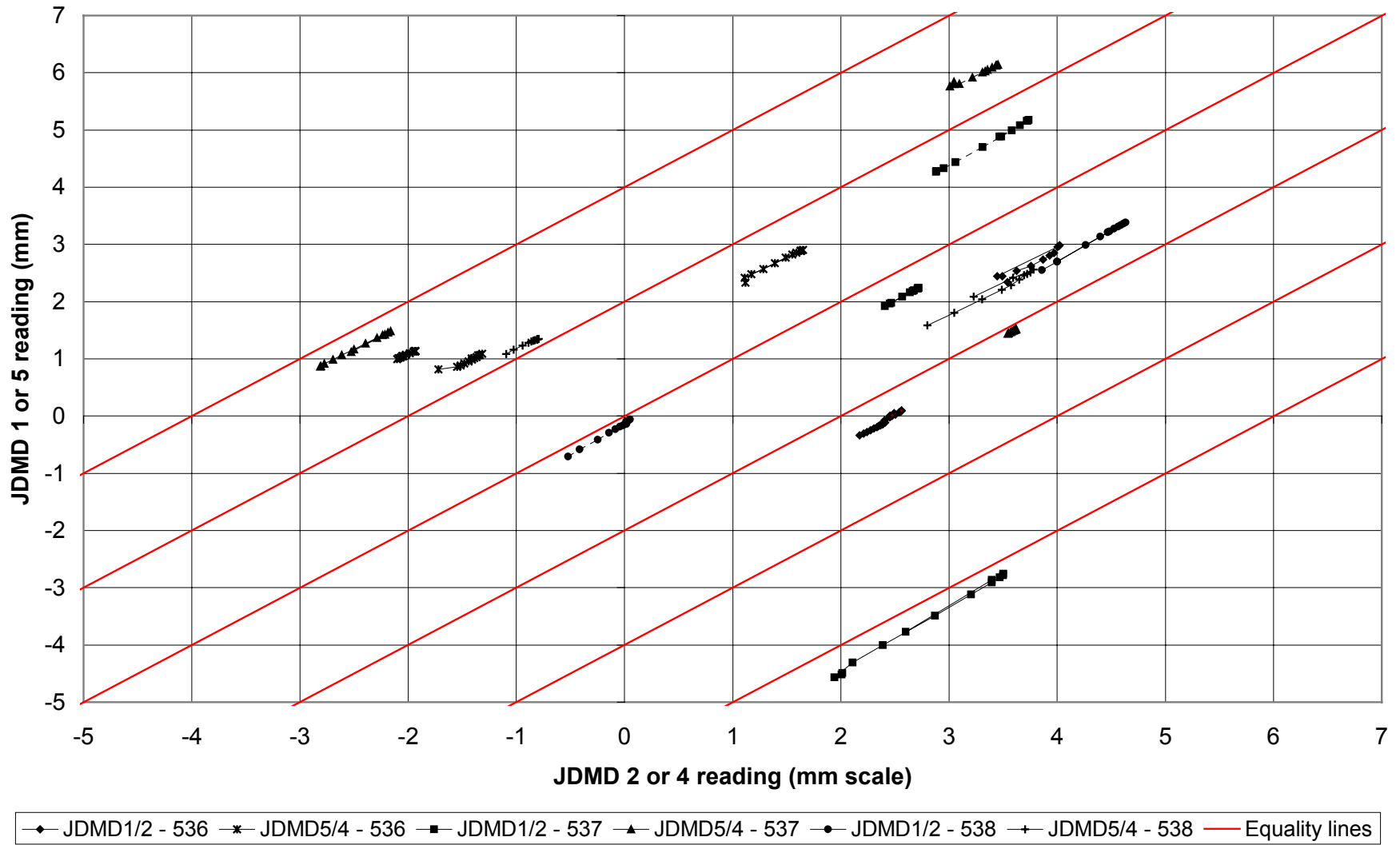

Figure 5.19. Relative movements across the joints for Design Section 9.

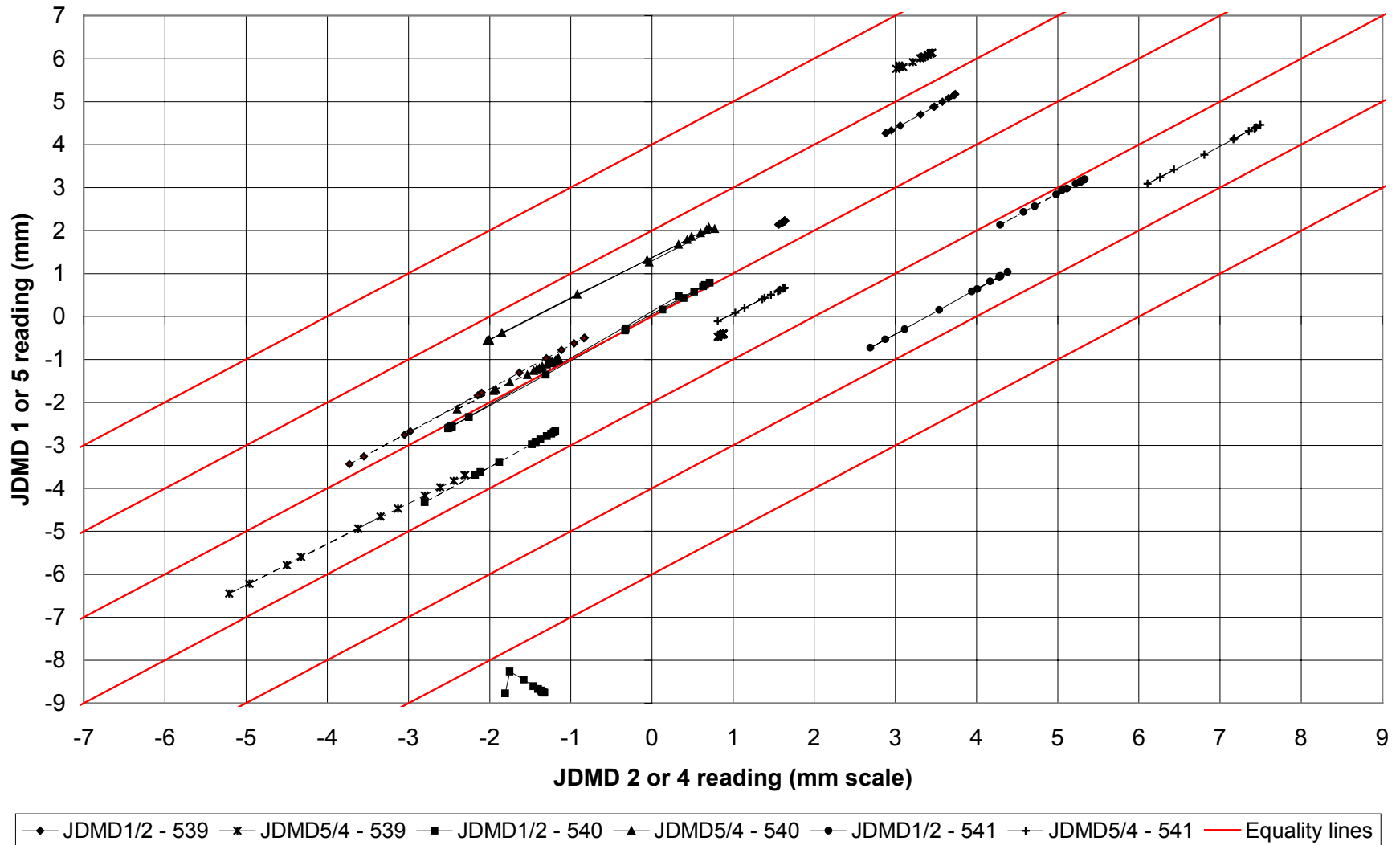

Figure 5.20. Relative movements across the joints for Design Section 11.

movements is generally much larger than for Design Section 9, in line with the lower constraint noted earlier.

Design Section 7 gives the poorest correlation of vertical movements on each side of the joints and, while not too inconsistent at this stage, clearly reflects the lack of inclusion of dowels on this section and probably foretells the likelihood of more rapid joint deterioration under traffic.

5.4 Summary of Vertical and Horizontal Movements

A summary of the most significant findings can be seen in Tables 5.2 and 5.3 for the vertical and horizontal movements, respectively.

The addition of tie bars and dowels between the slabs had a significant influence on the edge curling (see Table 5.2). The total maximum movement recorded by the JDMDs dropped from an average of 2.7 mm (Sections 534FD and 535FD) for the plain jointed sections without dowels to an average of 1.1 mm for the sections fitted with dowels and tie bars (Sections 536FD to 538FD). The sections with the widened lane with dowels but no tie bars show vertical edge movements similar to those sections without any dowels or tie bars. The average movement recorded was 2.7 mm for these sections (539FD to 541FD).

The tentative conclusion drawn from this data set is that curling due to the additional width (from 3.7 to 4.3 m) in the concrete slabs offset any reduction in the curling due to the dowels. The sections fitted with concrete shoulders with tie bars were more successful in restricting the vertical movements.

Care must be taken in the direct interpretation of these reported results. The movements reported are a direct effect of the maximum temperature differential of the various slabs at time of data collection as presented in Table 5.2. All vertical edge and corner movements should be

analyzed in conjunction with their respective temperature differentials. The interpretation of the horizontal movements is even more complex (Table 5.3) because they are also influenced by slab lengths as well the total day-to-night temperature variation.

The movements presented in Tables 5.2 and 5.3 are presented again in Table 5.4 normalized in terms of temperature differences for vertical movements, and Table 5.5 normalized in terms of maximum day-to-night surface temperature variations for horizontal movements. All movements are reported in microns ($\text{mm} \times 10^{-3}$) per degree Celsius.

Table 5.2 Summary of Vertical Surface Movements for All Test Sections

Case 1 Test pad completely exposed to sunlight	Total max vertical movement (mm)		Total temp differences (°C) (top - bottom of PCC layer)	
	corner movements	Edge movements	on the test pad in the sun	
534FD plain jointed	2.761	1.589	16.7	16.7
535FD no dowels & tie bars	2.561	1.261	16.3	16.3
536FD dowels	0.571	0.199	15.2	15.2
537FD &	1.812	0.789	16.2	16.2
538FD tie bars	0.982	0.190	11.5	11.5
539FD extra wide lane	2.972	2.239	17.5	17.5
540FD with	3.395	2.157	14.3	14.3
541FD dowels but no tie bars	1.756	0.959	12.3	12.3

Case 2 HVS parked onto test pad (without the temp box)	Total max vertical movement (mm)		Total temp differences (°C) (top - bottom of PCC layer)	
	corner movements	Edge movements	on the test pad in the sun	
534FD plain jointed	2.517	1.197	11.3	13.2
535FD no dowels & tie bars	1.398	0.768	6.7	9.4
536FD dowels	0.156	0.175	3.2	5.7
537FD &	0.909	0.545	5.7	20.8
538FD tie bars	0.649	0.049	11.4	6.0
539FD extra wide lane	0.909	0.545	5.7	15.6
540FD with	1.647	1.005	8.9	6.7
541FD dowels but no tie bars	1.064	0.535	6.0	6.0

Case 3 HVS parked onto test pad with temp box in operation	Total max vertical movement (mm)		Total temp differences (°C) (top - bottom of PCC layer)	
	corner movements	Edge movements	on the test pad in the sun	
534FD plain jointed	0.708	0.227	-1.0	12.8
535FD no dowels & tie bars	0.516	0.263	0.9	10.3
536FD dowels	0.408	0.053	-2.3	11.1
537FD &	0.320	0.193	-2.2	17.1
538FD tie bars	NA	NA	NA	NA
539FD extra wide lane	0.090	0.063	-2.6	12.1
540FD with	0.479	0.344	-2.8	15.1
541FD dowels but no tie bars	NA	NA	NA	NA

Table 5.3 Summary of Horizontal Movements for All Test Sections

Case 1 Test pad completely exposed to sunlight	Total maximum horizontal joint movement (mm)	Slab lengths (m)		Total day to night surface temp changes(°C)	
		Middle	Adjacent	on the test pad	in the sun
		534FD plain jointed	0.902		
535FD no dowels & tie bars	0.497	3.730	5.340	18.3	18.3
536FD dowels	0.449	3.970	3.620	18.4	18.2
537FD &	0.663	3.950	3.670	17.2	16.9
538FD tie bars	0.320	3.930	3.760	12.0	11.1
539FD extra wide lane	0.650	3.890	3.720	18.3	17.2
540FD with	0.680	3.870	3.770	12.4	12.4
541FD dowels but no tie bars	0.359	3.890	3.660	14.3	12.9

Case 2 HVS parked onto test pad (without the temp box)	Total maximum horizontal joint movement (mm)	Slab lengths (m)		Total day to night surface temp changes(°C)	
		Middle	Adjacent	on the test pad	in the sun
		534FD plain jointed	1.096		
535FD no dowels & tie bars	0.315	3.730	5.340	8.2	18.0
536FD dowels	0.178	3.970	3.620	7.4	21.0
537FD &	0.351	3.950	3.670	7.4	19.0
538FD tie bars	0.171	3.930	3.760	9.8	11.4
539FD extra wide lane	0.351	3.890	3.720	7.4	19.0
540FD with	0.265	3.870	3.770	9.4	12.7
541FD dowels but no tie bars	0.242	3.890	3.660	7.2	10.3

Case 3 HVS parked onto test pad with temp box in operation	Total maximum horizontal joint movement (mm)	Slab lengths (m)		Total day to night surface temp changes(°C)	
		Middle	Adjacent	on the test pad	in the sun
		534FD plain jointed	0.303		
535FD no dowels & tie bars	0.064	3.730	5.340	4.1	21.9
536FD dowels	0.082	3.970	3.620	4.5	19.5
537FD &	0.073	3.950	3.670	1.7	19.6
538FD tie bars	NA	3.930	3.760	NA	NA
539FD extra wide lane	0.015	3.890	3.720	2.4	14.2
540FD with	0.119	3.870	3.770	3.5	20.2
541FD dowels but no tie bars	NA	3.890	3.660	NA	NA

Table 5.4 Abbreviated Summary of Vertical Movements for All Test Sections, Temperature Normalized

Case 1 Test pad completely exposed to sunlight	Total max vertical movements (microns/°C)	
	Corner	Edge
534FD plain jointed	165.3	95.1
535FD no dowels & tie bars	157.1	77.4
Average movement:	161.2	86.3
536FD dowels	46.0	13.1
537FD &	111.8	48.7
538FD tie bars	85.4	16.5
Average movement:	81.1	26.1
539FD extra wide lane	169.8	127.9
540FD with	237.4	150.8
541FD dowels but no tie bars	142.8	77.9
Average movement:	183.3	118.9

Table 5.5 Abbreviated Summary of Horizontal Movements for All Test Sections, Temperature Normalized

Case 1 Test pad completely exposed to sunlight	Total max horizontal joint movements (microns/°C)	Slab lengths (m)	
		Middle	Adjacent
534FD plain jointed	43.8	3.91	3.80
535FD no dowels & tie bars	27.2	3.73	5.34
Average movement:	35.5		
536FD dowels	24.4	3.97	3.62
537FD &	38.5	3.95	3.67
538FD tie bars	26.7	3.93	3.76
Average movement:	29.9		
539FD extra wide lane	35.5	3.89	3.72
540FD with	54.8	3.87	3.77
541FD dowels but no tie bars	25.1	3.89	3.66
Average movement:	38.5		

For the vertical movements, the maximum temperature differential between the top and bottom of the slab was used to normalize the movements. The horizontal movements were normalized using the maximum surface day-to-night temperature change on the test pad. This was done because thermal expansion and contraction is mainly due to the maximum day-to-night temperature change and the vertical temperature gradient within the slab plays a lesser role.

Care should be taken in the interpretation of data presented in Tables 5.4 and 5.5. There is a non-linear relationship between the amount of concrete slab corner curl and the temperature difference between the top and bottom of the slab, which causes the slab to curl. The data as presented in Table 5.4 and 5.5 should, therefore, only be used for relative comparisons between the various structures.

From Table 5.4, it can be seen that the sections instrumented with dowels and tie bars were the most successful in terms of restricting slab corner curl and thermal expansion/contraction due to temperature fluctuations. An average vertical corner movement of 81.1 $\mu\text{m}/^\circ\text{C}$ was recorded in comparison with the undoweled, non-tied sections (161.2 $\mu\text{m}/^\circ\text{C}$), and

the widened lane sections ($183.3 \mu\text{m}/^\circ\text{C}$). Although the sample size is small and some variability exists, it appears that the sections with extra-wide lanes performed the worst in terms of their ability to restrict vertical corner movements due to temperature differentials in the slab.

Edge movements were the smallest in the case of dowels and tie bars ($26.1 \mu\text{m}/^\circ\text{C}$) in comparison with plain jointed ($86.3 \mu\text{m}/^\circ\text{C}$) and extra wide lane ($118.9 \mu\text{m}/^\circ\text{C}$).

Given the amount of scatter in the data presented in Table 5.5, it seems that the horizontal slab movement stayed relatively constant, regardless of the structure type. However, the sections with dowels and tie bars produced the lowest average horizontal movement ($29.9 \mu\text{m}/^\circ\text{C}$). It should be remembered that factors such as slab length and the degree and severity of transverse cracks all play an important role in the horizontal movements as recorded by the horizontal JDMD. An in-depth investigation of all these factors is necessary before final conclusions can be drawn regarding this data set.

The combined results from Table 5.3 and 5.4 are graphically displayed in Figure 5.21. From the figure, it can be seen that the sections constructed with dowels and tie bars were the most successful in terms of restricting the vertical edge and corner movements due to temperature fluctuations. On average, the wide lane sections performed the worst. The positive effects of the tie bars on restricting vertical edge movements are illustrated in the figure. Design Section 9 was the only section built with tie bars, and on average, it had the lowest recorded edge movements.

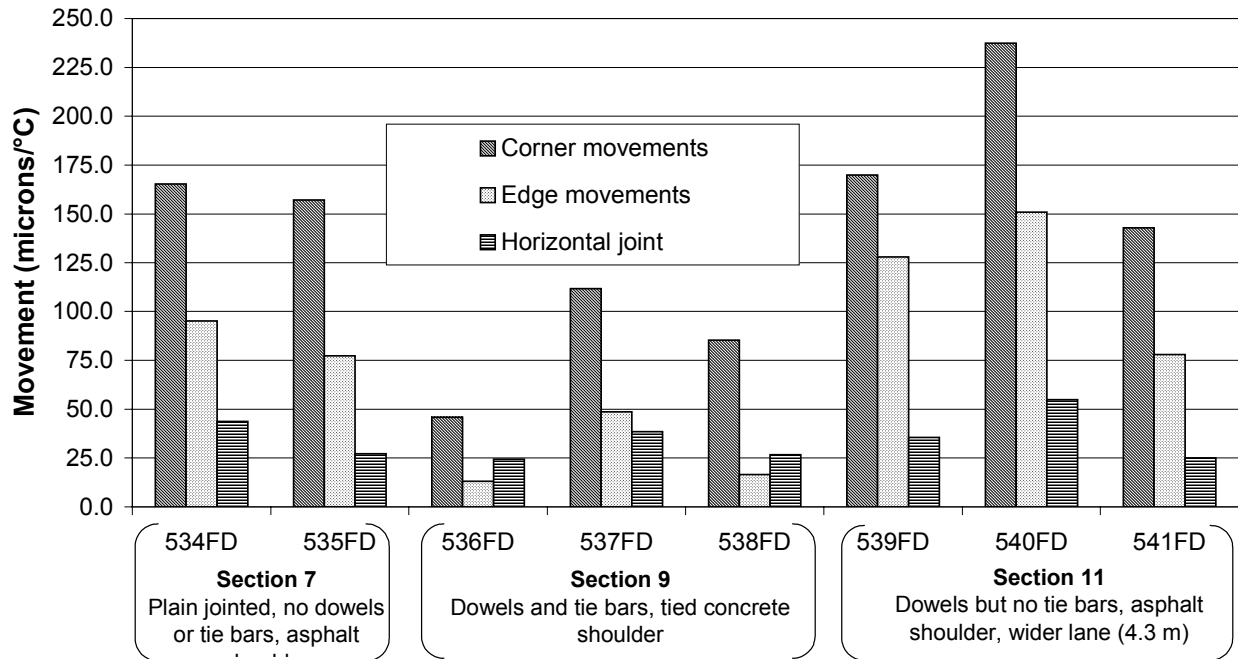

Figure 5.21. Summary of vertical and horizontal movements for all sections.

6.0 CONCLUSIONS

6.1 Summary

In this study, the environmental influences on concrete slab edge curling and slab contraction and expansion were investigated through a series of tests. Eight HVS test sections were monitored for vertical and horizontal slab edge elastic movements over 24 hours, without the influence of HVS loading. The only forces that acted on the pavement were the variable vertical temperature differential within the slabs, which caused the slabs to curl, and the day-to-night-temperature changes in the slabs, which caused the slabs to expand and contract horizontally.

Another effect that was quantified was that of the upward and downward curling movements along the longitudinal edges of the slabs. These movements were caused by cyclic temperature differentials between the top and bottom surfaces of the test sections.

Out of eight tests, two were performed on plain jointed concrete slabs without dowels and with an asphalt shoulder. Three tests were conducted on concrete slabs fitted with dowels and tied shoulders. The three remaining tests were conducted on test sections fitted with dowels and an asphalt shoulder and slab widths of 4.3 m instead of the standard 3.7 m.

Three temperature regimes were investigated:

- Test sections completely exposed to sunlight without the HVS parked on the sections;
- Test sections partially exposed to sunlight with the HVS parked on the sections, and
- Test sections partially exposed to sunlight with the HVS parked on it and a temperature control chamber erected over the test section with temperature kept at approximately 20°C.

6.2 Conclusions

The following significant conclusions can be drawn from the results presented in this report:

- The daily temperature variations and the associated temperature differentials (between the top and bottom of the pavement) have a significant influence on slab corner curl.
- During the day, as the exposed surface heats up, the top of the pavement expands more than the bottom of the pavement. This causes the edges of the slab to curl downward. The reverse effect was observed during the night: the bottom part of the slab retains more heat than the top part, which is exposed to the open (cold air). This causes the slab to curl upward.
- From the data collected in this study, it is clear that the downward curling movement, caused by a positive temperature differential, was more significant than the upward curling movement. A possible reason for this behavior is that this study was done during the early summer and fall and the positive temperature differential was always greater than the negative gradient. In general, the surface of the concrete did not cool off to the same extent that it heated up during the day.

It is important to note that the “original or natural state” of the concrete slab after setting is not necessarily perfectly planar. It is quite possible that, because of differential shrinkage between the top and the bottom of the slab, the shape of the slab at zero top-to-bottom temperature differential likely includes a permanent upward curl. It has been found in earlier reports (2) that the concrete used in the Palmdale sections did not produce a perfectly planar slab, and that lift-off between the slab and the base was observed all along the slab edge. This warped

shape is increased with an increasing negative temperature differential (which occurs normally at night).

The effects of the HVS parked on the test sections and the addition of temperature control with the temperature control chamber are summarized as follows:

- As expected, the maximum temperature and subsequent temperature differentials were lower on these test sections with the HVS compared to the sections completely exposed to direct sunlight.
- When the temperature control chamber was implemented, low vertical temperature differentials (typically less than 2.5°C) were recorded. This had a significant effect on the measured responses from the various instruments. In almost all cases, lower movements were recorded.
- There is a clear correlation between the recorded trends inside the temperature control chamber and the outside temperature differentials as recorded by thermocouples placed away from the influences of the HVS and the temperature control chamber. It is clear that even when good temperature control was exercised on the test sections, the influence of the exposed areas of the concrete slabs was still felt inside the temperature control chamber by the various sensors.
- In some cases, a distinct lag was observed between the time when a maximum temperature differential was observed away from the temperature control chamber and the time when an instrument within the temperature control chamber recorded the maximum movement. This lag was typically between 2 and 4 hours.

Conclusions drawn with respect to the strain gauges are as follows:

- Unfortunately, not all gauges were working after construction. These gauges were placed inside the concrete pavement during construction two years prior to the tests described in this report and some losses of strain gauges were anticipated.
- Behavior of the strain gauges depended on the type of gauge and the placement inside the pavement. Strains as high as 300 μ strain due to vertical temperature differential were recorded during a 24-hour observation window, but the maximum total strains recorded by the various gauges were generally in the order of 80 μ strain for the same period.
- Irrespective of their placement within the pavement, the strain gauges went through similar tension and compression phases within a 24-hour cycle due to the variation in daily temperature differential. The observed general trend was that the strain gauges were in tension during the day when the pavement was expanding, and in compression at night when the pavement was contracting.

7.0 REFERENCES

1. University of California at Berkeley, Dynatest Consulting Inc., and CSIR, Division of Roads and Transport Technology. *Test Plan for CAL/APT Goal LLPRS-Rigid Phase III*. Test Plan prepared for California Department of Transportation. April 1998.
2. Heath, A. and J. Roesler. *Shrinkage and Thermal Cracking of Fast Setting Hydraulic Cement Concrete Pavements in Palmdale, California*. Draft report prepared for California Department of Transportation. Pavement Research Center, CAL/APT Program, Institute of Transportation Studies, University of California, Berkeley. December 1999.