

**High Temperature Fatigue and Fatigue Damage Process of
Aggregate-Asphalt Mixes**

by

Bor-Wen Tsai

Report to California Department of Transportation

**University of California at Berkeley
Institute of Transportation Studies
Pavement Research Center**

ACKNOWLEDGEMENTS

This report was partially funded through the Federal Highway Administration National Cooperative Highway Research Program Project 9-20, “Performance-Related Specifications for Hot-Mix Asphalt Construction.”

Table of Contents

Table of Contents	v
List of Figures	xv
List of Tables	xxxviii
Introduction.....	1
1.1 Background.....	1
1.2 Research Objectives.....	6
1.3 Literature Review.....	7
1.3.1 History of Asphalt Concrete Fatigue Model Development	7
1.3.2 Crack Initiation and Crack Propagation.....	10
1.3.3 High Temperature Fatigue Test	12
1.3.4 Compound Strain-Based Fatigue Loading.....	16
1.3.5 The Weibull Function	18
1.3.6 Cumulative Fatigue Damage Prediction.....	19
1.3.7 Full-Scale Accelerated Pavement Tests.....	20
1.3.8 Shift Factor.....	21
1.4 Research Organization	25
2.0 Data Sources	27
2.1 WesTrack Project.....	27
2.1.1 Track Characteristics	28
2.1.2 Mix Characteristics	28
2.1.3 Traffic	30
2.1.4 Temperature	34

2.2	CAL/APT HVS Project.....	35
2.2.1	Section 503RF.....	35
2.2.2	Trafficking Plan	36
2.2.3	Multi-Depth Deflectometer (MDD).....	38
2.3	Laboratory Test Data	38
3.0	Test Plan, Specimen Preparation, and Test Setup.....	43
3.1	Test Purpose.....	43
3.2	Test Setup.....	44
3.2.1	Conventional Flexural Controlled-Strain Fatigue Test Setup.....	44
3.2.2	Modified Flexural Controlled-Strain Fatigue Test Setup	45
3.2.3	Instrumentation and Data Acquisition System	48
3.3	Specimen Preparation	53
3.3.1	Gradation Curves of WesTrack	53
3.3.2	Procedure of Specimen Preparation for WesTrack.....	54
3.4	Test Plan.....	60
3.4.1	High Temperature Modified Flexural Controlled-Strain Fatigue Test.....	60
3.4.2	Temperature Susceptibility Fatigue Test with Conventional Setup	62
3.4.3	Fatigue Test with Various Gradation Types	62
3.4.4	Flexural Frequency Sweep Test.....	63
3.4.5	Varied-Strain Fatigue Test.....	64
3.4.6	Varied-Temperature Fatigue Test.....	64
4.0	Fatigue Test Results and Analysis	67
4.1	Background.....	67

4.1.1	Interpretation of Weibull Curves	68
4.1.2	Crack Initiation and Weibull Curves	72
4.2	Fatigue Tests at 20°C	75
4.3	Temperature Susceptibility Fatigue Test (Field)	92
4.4	Temperature Susceptibility Fatigue Test (Laboratory).....	94
4.5	High Temperature Flexural Controlled-Strain Fatigue Test.....	95
4.6	Fatigue Test with Various Gradation Types	100
4.7	Pooled Fatigue Tests	101
4.8	Conventional Fatigue Analysis for WesTrack Project.....	102
4.8.1	Model Selection	102
4.8.2	Mallows' C_p Statistic.....	103
4.8.3	Data Description	104
4.8.4	A Regression Example: Coarse Gradation	104
4.8.5	Regression Analysis Results	111
4.9	Flexural Frequency Sweep Test.....	114
4.9.1	Test Results.....	114
4.9.2	Fitting with Gamma Distribution Function.....	118
4.10	Varied-Strain Fatigue Test.....	121
4.10.1	The Strain Effect on Weibull Curves.....	121
4.10.2	A Hypothesis of Strain-Caused Fatigue Damage	122
4.10.3	Test Results and Analysis	126
4.11	Varied-Temperature Fatigue Test.....	135
4.11.1	The Temperature Effect on Weibull Curves.....	135

4.11.2	A Hypothesis of Temperature-Caused Fatigue Damage	137
4.11.3	Test Results and Analysis	138
4.12	Findings and Discussions.....	144
4.12.1	Findings in Fatigue Test Results and Regression Analysis	144
4.12.2	Fatigue Life versus Temperature versus Strain Level	147
4.12.3	Crack Initiation and Crack Propagation.....	149
4.12.4	Weibull Curves at Extreme Test Temperatures	149
4.12.5	Coefficients of Weibull Curves	150
4.12.6	Problems of the High Temperature Fatigue Test.....	150
4.12.7	A General Hypothesis of Fatigue Damage	152
4.12.8	Time Hardening and Strain Hardening.....	153
5.0	Weibull Theory	159
5.1	Introduction.....	159
5.2	Survival Analysis	160
5.2.1	Survivor and Hazard Functions	161
5.2.2	Fatigue Damage Process and Survivor Function	162
5.3	Weibull Proportional Hazards Model	163
5.3.1	Weibull Density Function.....	163
5.3.2	Weibull Proportional Hazards Model.....	165
5.4	Weibull Equations of WesTrack Project.....	167
5.4.1	An Example: Fitting the Weibull PH Model	167
5.4.2	Weibull Equation of Coarse Gradation.....	172
5.4.3	Weibull Equation of Fine and Fine-Plus Gradations	176

5.5	Prediction of Fatigue Performance Using Weibull Theory	177
5.6	Miner’s Law and Weibull Theory.....	181
5.6.1	Miner’s Law in Explanation with Stiffness Ratio.....	182
5.6.2	Generalized Miner’s Law	185
5.7	Weibull Accelerated Failure Time Model	187
5.7.1	Introduction.....	187
5.7.2	Accelerated Failure Time Model	189
5.7.3	Demonstration Example.....	192
5.7.4	Mode Factor and Controlled-Strain Fatigue Test	197
5.7.5	Findings and Discussions.....	200
6.0	Westrack Simulation using Miner’s Law	207
6.1	Introduction.....	207
6.2	WesTrack Data Summary.....	211
6.2.1	Temperature Distribution.....	211
6.2.2	Traffic Pattern.....	218
6.3	Mechanistic-Empirical Models for Stiffness and Fatigue Life.....	223
6.3.1	Stiffness Models.....	225
6.3.2	Fatigue Life Models.....	226
6.4	Stratification of the WesTrack Temperature Data	227
6.5	Tensile Strain Function Using Circly Program.....	229
6.5.1	WesTrack Pavement Structure and Loading Configuration	229
6.5.2	Circly Program with 110×3×3 Cases.....	229
6.5.3	Bi-Normal Density Function.....	230

6.5.4	Regression Analysis for Strain Function	233
6.6	Fatigue Performance Prediction Simulation (Crack Initiation)	235
6.6.1	Simulation Procedures	235
6.6.2	Simulation Results	245
6.7	Findings and Discussions.....	251
7.0	Weibull Simulation	255
7.1	General Considerations.....	255
7.1.1	Algorithm of Weibull Program.....	255
7.1.2	Program Elements and Flow Charts	256
7.1.3	Scope of Simulation.....	264
7.1.4	Failure Criterion.....	267
7.1.5	Stiffness, Temperature, and Stiffness Ratio.....	269
7.1.6	Stiffness as an Input.....	270
7.1.7	Wander Consideration	272
7.1.8	Vehicle Speed and Stiffness.....	273
7.1.9	Traffic Wander, Traffic Composition, and Vehicle Speed	274
7.2	Simulation Results of WesTrack	274
7.3	Traffic Pattern and Simulation.....	291
7.4	Weather and Simulation.....	298
7.5	Traffic and Weather Effects.....	299
7.6	Construction Variability and Simulation	307
7.6.1	Degree of Compaction	307
7.6.2	Thickness of the Asphalt Concrete Layer.....	317

7.6.3	Asphalt Content	330
7.7	Correction Factor and Simulation Results	335
7.8	Findings and Discussions.....	346
8.0	Conclusions and Recommendations	349
8.1	Are there primary rules of fatigue performance for asphalt-aggregate mixes?	349
8.2	Is the Weibull function the unique solution to describe fatigue damage process?	349
8.3	What is learned from the Weibull simulations of WesTrack?	350
8.4	“Miner’s Approach” or the “Weibull Approach”?	351
8.5	Will the rutting mechanism interact with the fatigue mechanism?.....	352
8.6	Is the correction factor important to fatigue performance prediction?	353
8.7	Can the crack propagation model be an extension model of crack initiation?	354
8.8	Is the Weibull dynamic approach the “poor man’s” Finite Element Method?	354
8.9	“Time Hardening” or “Strain-Hardening” or both or...?	355
8.10	“Problem solving” or “Problem making”?	356
8.11	Next Step?.....	356
References	359
Appendix A:	367
Appendix B:	391
Appendix C: Flexural Beam Analysis and S-PLUS Code for Chapter 4	469
C.1.	Flexural Beam Analysis Using Strain Gage Data.....	469
C.1.1.	Analysis without Aluminum Support	469
C.1.2	Analysis with Aluminum Support	471
C.2.	Flexural Frequency Sweep Test.....	473

C.2.1	Analysis of Without-Support Setup	474
C.2.2	Analysis of With-Support Setup	475
C.3	High Temperature Fatigue Test	476
	S-PLUS code for the high temperature fatigue analysis.....	477
C.4	Varied-Strain Fatigue Test	480
C.5	Simulation of Correlated Random Variables	482
Appendix D:	S-PLUS Code for Chapter 6.....	485
D.1	S-PLUS Code for Stratification	485
D.1.1	cellsum() Function.....	486
D.1.2	Findcell() Function	487
D.1.3	Stratification Output of the WesTrack Field Data	488
D.2	S-PLUS Code for Crack Initiation Simulation	491
Appendix E:	Weibull User's Manual.....	495
E.1	General DEscription.....	495
E.1.1	Introduction.....	495
E.1.2	Program Elements and Flow Charts	496
	Module Strain_Engine.....	497
	Module ELSYM5_Program.....	497
	Module Link_List	499
	Module Equations.....	499
	Module ELSYM5_File_Modify	500
	Main Program Weibull_Simulation.....	500
E.1.3	Weibull Theory.....	501

E.1.3.1 Weibull Density Function	505
E.1.3.2 Weibull Proportional Hazards Model	507
E.1.3.3 Fitting the Weibull PH Model.....	509
E.1.4 Weibull Accelerated Failure Time Model	515
E.1.5 Wander Consideration	518
E.1.6 Stiffness, Temperature, and Stiffness Ratio.....	519
E.1.7 Vehicle Speed and Stiffness.....	521
E.1.8 Traffic Wander, Traffic Composition, and Vehicle Speed.....	523
E.1.9. Random wander generation	525
E.1.10 Random traffic composition generation.....	525
E.1.11 Random vehicle speed generation	527
E.2 Input Data.....	528
E.2.1 ELSYM5 Input File	528
E.2.2 Environment and Material File	530
E.2.3 Traffic File	531
E.2.4 Stiffness and Weibull regression equations File.....	532
E.3 Output	534
E.4 Examples.....	534
E.4.1 Example Problem 1.....	535
E.4.2 Example Problem 2.....	540
E.5 Source code.....	543
E.5.1 Main Program: Weibull_Simulation.....	543
E.5.2 Module Strain_Engine	552

E.5.3	Module: Equations	555
E.5.4	Module: ELSYM5_File_Modify	560
E.5.5	Module: Link_List	563
E.5.6	Module: ELSYM5_Program.....	566
E.5.7	Data Modules of ELSYM5_Program	597

LIST OF FIGURES

Figure 1.1. (a) Fatigue life versus strain with various stiffnesses; (b) and (c) stiffness and tensile strain as a function of temperature; (d) fatigue life versus strain with various temperatures.	4
Figure 1.2. Image-and-contour plot of the maximum tensile strains of pavement with a dual-tire traffic load (simulation case: $T_b = 35^\circ\text{C}$, temperature gradient = 0.06).	5
Figure 1.3. Crack initiation and crack propagation.	13
Figure 1.4. Controlled-strain fatigue diagram (after Pell).	15
Figure 1.5. Effect of rest period on life ratio (after Raithby).	15
Figure 1.6. Procedures to predict cumulative loading from results of simple loading test (after Monismith 1975).	17
Figure 1.7. Methodology followed in the fatigue analysis system to determine ESALs (after Harvey 1997).	23
Figure 2.1. Layout of WesTrack test track (not to scale).	29
Figure 2.2. Individual WesTrack gradation curves on a 19-mm nominal size 0.45 power chart.	31
Figure 2.3. Individual WesTrack gradation curves on a semi-logarithmic chart.	31
Figure 2.4. Driverless triple-trailer test trucks.	33
Figure 2.5. Tractor/trailer configuration.	33
Figure 2.6. 503RF pavement structure with MDD and thermocouple positioning (after Harvey 1997).	37
Figure 2.7. Plan view of test section and location of instruments for data collection (after Harvey 1997).	39
Figure 2.8. LVDT module of MDD (after CSIR).	40
Figure 2.9. Anchor assembly of the MDD installation set in concrete at depth of about 3 meters (after CSIR).	40

Figure 3.1. Conventional fatigue testing machine.	45
Figure 3.2. Schematic plots of conventional and modified flexural fatigue test setups.	47
Figure 3.3. Modified fatigue test setup with temperature control box.....	49
Figure 3.4. Modified fatigue test setup: inside view.....	49
Figure 3.5. Modified fatigue test setup: side view (1).	50
Figure 3.6. Modified fatigue test setup: side view (2).	50
Figure 3.7. Strain gages attached on beam and aluminum support.	51
Figure 3.8. Wheatstone bridge.	51
Figure 3.9. Strain gage locations and dimensions of asphalt concrete beam, TEFLON™ sheet, and aluminum support.....	52
Figure 3.10. Individual WesTrack coarse gradation curves on a 19-mm nominal size 0.45 power chart.....	55
Figure 3.11. Individual WesTrack coarse gradation curves on a semi-logarithmic chart.	55
Figure 3.12. Individual WesTrack fine gradation curves on a 19-mm nominal size 0.45 power chart.....	56
Figure 3.13. Individual WesTrack fine gradation curves on a semi-logarithmic chart.	56
Figure 4.1. An example of fitting the Weibull survivor function to a fatigue test result in terms of $\ln(-\ln(SR))$ versus $\ln(n)$	70
Figure 4.2. An example of fitting the Weibull survivor function to a fatigue test result in terms of $\ln(-\ln(SR))$ versus $\ln(\ln(n))$	70
Figure 4.3. Two parallel Weibull curves.	71
Figure 4.4. Two concurrent Weibull curves.	71
Figure 4.5. Weibull curves in reversed S shape.....	74

Figure 4.6. Weibull curve in three phases: (1) Phase I: Heating and arrived at temperature equilibrium, (2) Phase II: Crack initiation developing, and (3) Phase III: Crack propagating.	74
Figure 4.7. Pairs diagram for <i>lnstif</i> and <i>lnnf</i> (fatigue tests at 20°C).	77
Figure 4.8. Pairs diagram for the regression coefficients <i>aa</i> , <i>bb</i> , <i>cc</i> , and <i>dd</i> of the Weibull curves (fatigue tests at 20°C).....	78
Figure 4.9. Scatterplots of 500 independent pairs of bivariate normal random variables with correlation coefficient $\rho = 0.2$, $\rho = 0.4$, $\rho = 0.6$, $\rho = 0.8$, $\rho = 0.0$, and $\rho = 0.99$	79
Figure 4.10. Design plot of <i>lnstif</i> (fatigue tests at 20°C).	82
Figure 4.11. Design plot of <i>lnnf</i> (fatigue tests at 20°C).	82
Figure 4.12. Design plot of <i>aa</i> (fatigue tests at 20°C).	83
Figure 4.13. Design plot of <i>bb</i> (fatigue tests at 20°C).	83
Figure 4.14. Design plot of <i>cc</i> (fatigue tests at 20°C).	84
Figure 4.15. Design plot of <i>dd</i> (fatigue tests at 20°C).	84
Figure 4.16. Boxplots for factor <i>grad</i> (fatigue tests at 20°C).	86
Figure 4.17. Boxplots for factor <i>ac</i> (fatigue tests at 20°C).	86
Figure 4.18. Boxplots for factor <i>av</i> (fatigue tests at 20°C).	87
Figure 4.19. Boxplots for factor <i>stn</i> (fatigue tests at 20°C).	87
Figure 4.20. Boxplots for factor <i>rs4s50</i> (fatigue tests at 20°C).	88
Figure 4.21. Boxplots for factor <i>m200</i> (fatigue tests at 20°C).	88
Figure 4.22. Boxplots for factor <i>sa</i> (fatigue tests at 20°C).	89
Figure 4.23. Boxplots for factor <i>vma</i> (fatigue tests at 20°C).	89
Figure 4.24. Boxplots for factor <i>vfa</i> (fatigue tests at 20°C).	90

Figure 4.25. Weibull curves in two strain groups (fatigue tests at 20°C).....	90
Figure 4.26. Test results of high temperature fatigue test for CM mixes.....	98
Figure 4.27. Test results of high temperature fatigue test for FM mixes.....	99
Figure 4.28. Flexural frequency sweep test results for FM mixes at 300 microstrain.....	116
Figure 4.29. Flexural frequency sweep test results for CM mixes at 300 microstrain.....	117
Figure 4.30. Gamma distribution curves with shape parameter $n = 2$ and scale parameters $\beta =$ 0.1, 0.2, 0.5, 1, 1.5, and 2.....	120
Figure 4.31. Gamma distribution curves with shape parameter $n = 5$ and scale parameters $\beta =$ 0.1, 0.2, 0.5, 1, 1.5, and 2.....	121
Figure 4.32. Nonlinear fitting of flexural frequency sweep test using Gamma distribution function (modified fatigue test setup).....	123
Figure 4.33. Nonlinear fitting of flexural frequency sweep test using Gamma distribution function (conventional fatigue test setup).....	123
Figure 4.34. Weibull curves at various strain levels.....	124
Figure 4.35. Stiffness deterioration curves at various strains in terms of SR versus repetition.	125
Figure 4.36. Stiffness deterioration curves at various strains in terms of stiffness versus repetition.....	125
Figure 4.37. A 200-400-200 sequential fatigue test.....	128
Figure 4.38. A 400-200-400 sequential fatigue test.....	128
Figure 4.39. A 400-200 sequential fatigue test.....	130
Figure 4.40. A 200-400 sequential fatigue test.....	130
Figure 4.41. A summary of varied-strain fatigue tests in terms of SR versus repetition.....	132
Figure 4.42. A summary of varied-strain fatigue tests in terms of stiffness versus repetition. .	133

Figure 4.43. Cumulative dissipated energy plot for varied-strain fatigue tests.	134
Figure 4.44. Weibull curves at various temperatures.	136
Figure 4.45. Stiffness deterioration curves at various temperatures in terms of SR versus repetition.	136
Figure 4.46. Stiffness deterioration curves at various temperatures in terms of stiffness versus repetition.	137
Figure 4.47. Time needed for internal temperature stabilization of a beam.	140
Figure 4.48. A 20-30-20 sequential fatigue test.	141
Figure 4.49. A 30-20-30 sequential fatigue test.	142
Figure 4.50. A 30-20 sequential fatigue test.	142
Figure 4.51. A 20-30 sequential fatigue test.	143
Figure 4.52. A summary of varied-temperature fatigue tests in terms of stiffness versus repetition.	145
Figure 4.53. Cumulative dissipated energy plot for varied-temperature fatigue tests.	146
Figure 4.54. Boxplot of fatigue life versus temperature (°C).	148
Figure 4.55. Boxplot of fatigue life versus strain.	148
Figure 4.56. Weibull curves at extreme temperatures.	151
Figure 4.57. Application of time hardening procedure from a low damage state to a high damage state in terms of SR.	154
Figure 4.58. Application of time hardening procedure from a high damage state to a low damage state in terms of SR.	155
Figure 4.59. Application of strain hardening procedure from a low damage state to a high damage state in terms of SR.	156

Figure 4.60. Application of strain hardening procedure from a high damage state to a low damage state in terms of SR.....	157
Figure 5.1. Stiffness deterioration curve fitted with a Weibull survivor function with $\lambda = 0.002$ and $\gamma = 0.412$	164
Figure 5.2. Weibull density function with $\lambda = 0.002$ and $\gamma = 0.412$	164
Figure 5.3. Weibull curves for fine-plus gradation at temperature 5°C.....	168
Figure 5.4. Weibull curves for fine-plus gradation at temperature 20°C.....	169
Figure 5.5. Weibull curves for fine-plus gradation at temperature 30°C.....	169
Figure 5.6. Weibull regression fitting and real data for fine-plus gradation.....	173
Figure 5.7. Residual plots of Weibull regression equation for coarse gradation.	175
Figure 5.8. Residual plots of Weibull regression equation for fine and fine-plus gradations. ..	178
Figure 5.9. Change of stiffness ratios along various stiffness deterioration curves.	180
Figure 5.10. Construction of the compound stiffness deterioration curve with Weibull dynamic approach.....	180
Figure 5.11. Prediction of fatigue life (adapted from Monismith, et al., 1961).....	182
Figure 5.12. Miner’s Law in explanation with stiffness ratio and fatigue life.....	184
Figure 5.13. Comparison between Miner’s Law and Weibull theory.....	187
Figure 5.14. Weibull accelerated failure time model with different correction factors.....	192
Figure 5.15. Back-calculated moduli of CAL/APT Goal 1 Section 503RF with test wheel loads of 40 kN and 100 kN subjected to a test temperature of $20 \pm 3^\circ\text{C}$	194
Figure 5.16. Fitted Weibull equation of back-calculated moduli of Section 503RF with a 40-kN test wheel load.....	196
Figure 5.17. Relationship of $ A / B $ ratio versus MF.	199

Figure 5.18. History of maximum tensile strain of Section 503RF.....	201
Figure 5.19. History of mode factor of Section 503RF.....	202
Figure 6.1. Flow chart of the simulation procedure for fatigue performance prediction (crack initiation time).....	210
Figure 6.2. Temperature spectrum of WesTrack at a depth of 50 mm from 3/3/96 to 10/2/98.	212
Figure 6.3. Temperature density function of WesTrack at a depth of 50 mm from 3/3/96 to 10/2/98.....	213
Figure 6.4. Temperature distribution function of WesTrack at a depth of 50 mm from 3/3/96 to 10/2/98.....	213
Figure 6.5. Temperature spectrum of WesTrack at a depth of 150 mm from 3/3/96 to 10/2/98.....	214
Figure 6.6. Temperature density function of WesTrack at a depth of 150 mm from 3/3/96 to 10/2/98.....	215
Figure 6.7. Temperature distribution function of WesTrack at a depth of 150 mm from 3/3/96 to 10/2/98.....	215
Figure 6.8. Spectrum of temperature gradient at WesTrack from 3/3/96 to 10/2/98.....	216
Figure 6.9. Temperature gradient's density function at WesTrack from 3/3/96 to 10/2/98.....	217
Figure 6.10. Temperature gradient's distribution function at WesTrack from 3/3/96 to 10/2/98.....	217
Figure 6.11. Applied traffic at various wander locations of WesTrack.....	219
Figure 6.12. Typical highway wander pattern (after Allen).....	220
Figure 6.13. Bar charts of applied traffic at various wander locations at different periods of WesTrack: (a) 3/3/96-7/15/96: no wander or antenna off, (b) 7/16/96-12/14/96: traffic only	

at 5R and 5L, (c) 12/15/96-2/18/97: only 135,249 ESALs applied, and (d) 2/19/97-9/3/98: varied wander pattern.....	221
Figure 6.14. Bar chart of applied traffic at various wander locations from 3/3/96-9/3/98.....	222
Figure 6.15. Plot of cumulative ESALs and temperature spectrum at a depth of 150 mm.	224
Figure 6.16. Maximum tensile strains fitted with a bi-normal distribution functions, $N(0.0010,$ $0.1361)$ and $N(0.3551, 0.1361)$, with a multiplication factor of $A = 0.0001435$, subjected to the following simulation case: $T_b = 41.10^\circ\text{C}$, $g = 0.1091$, $sg = 95.79\text{ MPa}$, $av = 13.7\%$, and $ac = 6.22\%$	232
Figure 6.17. Maximum Tensile strains fitted with a bi-normal distribution functions, $N(-0.0188,$ $0.1806)$ and $N(0.3751, 0.1806)$, with a multiplication factor of $A = 0.0001435$, subjected to the following simulation case: $T_b = -2.24^\circ\text{C}$, $g = -0.0518$, $sg = 113.30\text{ MPa}$, $av = 13.7\%$, and $ac = 6.22\%$	232
Figure 6.18. Illustration of tensile strain calculation with wander.	241
Figure 6.19. Fatigue performance prediction of crack initiation with and without wander for Section 8.....	244
Figure 6.20. Simulation results of fatigue performance prediction and condition survey of 26 original test sections of the WesTrack project.....	247
Figure 6.21. Simulation results of fatigue performance prediction and condition survey of coarse mixes of the WesTrack project.	248
Figure 6.22. Simulation results of fatigue performance prediction and condition survey of fine mixes of the WesTrack project.	249
Figure 6.23. Simulation results of fatigue performance prediction and condition survey of fine- plus mixes of the WesTrack project.....	250

Figure 7.1. “Node-by-node” and “hour-by-hour” algorithm of <i>Weibull</i> program.....	257
Figure 7.2. Module relationship of <i>Weibull</i> program.....	259
Figure 7.3. Flow chart of <i>Weibull</i> main program.....	262
Figure 7.4. Flow chart of the <code>process_one_hour ()</code> subroutine.....	263
Figure 7.5. Loading configuration, pavement structure, and ELSYM5 input of WesTrack for Weibull simulation.....	265
Figure 7.6. Relationship between initial stiffness and stiffness ratio.....	271
Figure 7.7. A wander example of stiffness deterioration curves arranged in various depths at different offsets of Section 3.....	276
Figure 7.8. Stiffness deterioration of WesTrack section 3 and WesTrack traffic and environmental factors: (a) temperature and cumulative traffic and (b) stiffness deterioration and cumulative traffic.....	277
Figure 7.9. Image-and-contour plots of SR of WesTrack Section 3 after 21,943 hours of simulation with a correction factor of 1.0: (a) wander and (b) no wander.....	278
Figure 7.10. Image-and-contour plots of SR of WesTrack Section 8 after 21,943 hours of simulation with a correction factor of 1.0: (a) wander and (b) no wander.....	279
Figure 7.11. Stiffness deterioration curves of WesTrack coarse sections at a location of the weakest point of the no-wander case.....	281
Figure 7.12. Stiffness deterioration curves of WesTrack fine sections at a location of the weakest point of the no-wander case.....	282
Figure 7.13. Stiffness deterioration curves of WesTrack fine-plus sections at a location of the weakest point of the no-wander case.....	283

Figure 7.14. The Weibull simulation results and condition survey of coarse mixes of the WesTrack project.....	287
Figure 7.15. The Weibull simulation results and condition survey of fine mixes of the WesTrack project.....	289
Figure 7.16. The Weibull simulation results and condition survey of fine-plus mixes of the WesTrack project.....	290
Figure 7.17. Image-and-contour plots of SR of WesTrack Section 3 with modified traffic pattern: (a) wander and (b) no wander.....	293
Figure 7.18. Stiffness deterioration curves of WesTrack Section 3 with modified traffic pattern.....	295
Figure 7.19. Image-and-contour plots of SR of WesTrack Section 8 with modified traffic pattern: (a) wander and (b) no wander.....	296
Figure 7.20. Stiffness deterioration curves of WesTrack Section 8 with modified traffic pattern.....	297
Figure 7.21. Image-and-contour plots of SR of WesTrack Section 3 with modified weather pattern: (a) wander and (b) no wander.....	300
Figure 7.22. Stiffness deterioration curves of WesTrack Section 3 with modified weather pattern.....	301
Figure 7.23. Image-and-contour plots of SR of WesTrack Section 8 with modified weather pattern: (a) wander and (b) no wander.....	302
Figure 7.24. Stiffness deterioration curves of WesTrack Section 8 with modified weather pattern.....	303

Figure 7.25. Image-and-contour plots of SR of WesTrack Section 3 with modified weather and traffic patterns: (a) wander and (b) no wander.....	305
Figure 7.26. Stiffness deterioration curves of WesTrack Section 3 with various weather and traffic patterns.	306
Figure 7.27. Image-and-contour plots of SR of WesTrack Section 8 with modified weather and traffic patterns: (a) wander and (b) no wander.....	308
Figure 7.28. Stiffness deterioration curves of WesTrack Section 8 with various weather and traffic patterns.	309
Figure 7.29. Image-and-contour plots of SR of WesTrack Section 3 with 2 % less air-void content (10.4 %): (a) wander and (b) no wander.	311
Figure 7.30. Image-and-contour plots of SR of WesTrack Section 3 with 2 % more air-void content (14.4 %): (a) wander and (b) no wander.	312
Figure 7.31. Stiffness deterioration curves of WesTrack Section 3 with various air-void contents.	313
Figure 7.32. Image-and-contour plots of SR of WesTrack Section 8 with 2 % less air-void content (6.5 %): (a) wander and (b) no wander.	314
Figure 7.33. Image-and-contour plots of SR of WesTrack Section 8 with 2 % more air-void content (10.5 %): (a) wander and (b) no wander.	315
Figure 7.34. Stiffness deterioration curves of WesTrack Section 8 with various air-void contents.	316
Figure 7.35. Image-and-contour plots of SR of WesTrack Section 3 with 5-inch thickness of asphalt concrete: (a) wander and (b) no wander.	318

Figure 7.36. Image-and-contour plots of SR of WesTrack Section 3 with 6-inch thickness of asphalt concrete: (a) wander and (b) no wander.	319
Figure 7.37. Image-and-contour plots of SR of WesTrack Section 3 with 7-inch thickness of asphalt concrete: (a) wander and (b) no wander.	320
Figure 7.38. Stiffness deterioration curves of WesTrack Section 3 with various thicknesses of asphalt concrete.	321
Figure 7.39. Image-and-contour plots of SR of WesTrack Section 8 with 5-inch thickness of asphalt concrete: (a) wander and (b) no wander.	322
Figure 7.40. Image-and-contour plots of SR of WesTrack Section 8 with 6-inch thickness of asphalt concrete: (a) wander and (b) no wander.	323
Figure 7.41. Image-and-contour plots of SR of WesTrack Section 8 with 7-inch thickness of asphalt concrete: (a) wander and (b) no wander.	324
Figure 7.42. Stiffness deterioration curves of WesTrack Section 8 with various thicknesses of asphalt concrete.	325
Figure 7.43. Strain history of WesTrack Section 8 with modified traffic pattern.	327
Figure 7.44. Strain history of WesTrack Section 15 with modified traffic pattern.	327
Figure 7.45. Differential average tensile strain of Section 15 (fine) and Section 8 (coarse) of WesTrack.	328
Figure 7.46. Image-and-contour plot of SR of WesTrack Section 3 with 0.5 % less asphalt content (4.47 %): (a) wander and (b) no wander.	329
Figure 7.47. Image-and-contour plot of SR of WesTrack Section 3 with 0.5 % more asphalt content (5.47 %): (a) wander and (b) no wander.	331

Figure 7.48. Stiffness deterioration curves of WesTrack Section 3 with various asphalt contents.	332
Figure 7.49. Image-and-contour plots of SR of WesTrack Section 8 with 0.5 % less asphalt content (4.97 %): (a) wander and (b) no wander.	333
Figure 7.50. Image-and-contour plots of SR of WesTrack Section 8 with 0.5 % more asphalt content (5.97 %): (a) wander and (b) no wander.	334
Figure 7.51. Stiffness deterioration curves of WesTrack Section 8 with various asphalt contents.	336
Figure 7.52. Image-and-contour plots of SR of WesTrack Section 3 with a correction factor of 0.8: (a) wander and (b) no wander.	340
Figure 7.53. Image-and-contour plots of SR of WesTrack Section 3 with a correction factor of 1.2: (a) wander and (b) no wander.	341
Figure 7.54. Stiffness deterioration curves of WesTrack Section 3 with various correction factors.....	342
Figure 7.55. Image-and-contour plots of SR of WesTrack Section 8 with a correction factor of 0.8: (a) wander and (b) no wander.	343
Figure 7.56. Image-and-contour plots of SR of WesTrack Section 8 with a correction factor of 1.2: (a) wander and (b) no wander.	344
Figure 7.57. Stiffness deterioration curves of WesTrack Section 8 with various correction factors.....	345
Figure B.4.1. Design plot of <i>lnstif</i> (temperature susceptibility fatigue test, field-mixed and field- compacted).	392

Figure B.4.2. Design plot of <i>lnnf</i> (temperature susceptibility fatigue test, field-mixed and field-compacted).....	392
Figure B.4.3. Design plot of <i>aa</i> (temperature susceptibility fatigue test, field-mixed and field-compacted).....	393
Figure B.4.4. Design plot of <i>bb</i> (temperature susceptibility fatigue test, field-mixed and field-compacted).....	393
Figure B.4.5. Design plot of <i>cc</i> (temperature susceptibility fatigue test, field-mixed and field-compacted).....	394
Figure B.4.6. Design plot of <i>dd</i> (temperature susceptibility fatigue test, field-mixed and field-compacted).....	394
Figure B.4.7. Design plot of <i>lnstif</i> (temperature susceptibility fatigue test, lab.-mixed and lab.-compacted).....	395
Figure B.4.8. Design plot of <i>lnnf</i> (temperature susceptibility fatigue test, lab.-mixed and lab.-compacted).....	395
Figure B.4.9. Design plot of <i>aa</i> (temperature susceptibility fatigue test, lab.-mixed and lab.-compacted).....	396
Figure B.4.10. Design plot of <i>bb</i> (temperature susceptibility fatigue test, lab.-mixed and lab.-compacted).....	396
Figure B.4.11. Design plot of <i>cc</i> (temperature susceptibility fatigue test, lab.-mixed and lab.-compacted).....	397
Figure B.4.12. Design plot of <i>dd</i> (temperature susceptibility fatigue test, lab.-mixed and lab.-compacted).....	397
Figure B.4.13. Design plot of <i>lnstif</i> (high temperature fatigue test).....	398

Figure B.4.14. Design plot of <i>lnnf</i> (high temperature fatigue test).....	398
Figure B.4.15. Design plot of <i>aa</i> (high temperature fatigue test).....	399
Figure B.4.16. Design plot of <i>bb</i> (high temperature fatigue test).....	399
Figure B.4.17. Design plot of <i>cc</i> (high temperature fatigue test).	400
Figure B.4.18. Design plot of <i>dd</i> (high temperature fatigue test).....	400
Figure B.4.19. Design plot of <i>lnstif</i> (fatigue test with various gradations at 20°C).....	401
Figure B.4.20. Design plot of <i>lnnf</i> (fatigue test with various gradations at 20°C).	401
Figure B.4.21. Design plot of <i>aa</i> (fatigue test with various gradations at 20°C).....	402
Figure B.4.22. Design plot of <i>bb</i> (fatigue test with various gradations at 20°C).....	402
Figure B.4.23. Design plot of <i>cc</i> (fatigue test with various gradations at 20°C).	403
Figure B.4.24. Design plot of <i>dd</i> (fatigue test with various gradations at 20°C).....	403
Figure B.4.25. Design plot of <i>lnstif</i> (pooled fatigue tests).....	404
Figure B.4.26. Design plot of <i>lnnf</i> (pooled fatigue tests).....	404
Figure B.4.27. Design plot of <i>aa</i> (pooled fatigue tests).....	405
Figure B.4.28. Design plot of <i>bb</i> (pooled fatigue tests).....	405
Figure B.4.29. Design plot of <i>cc</i> (pooled fatigue tests).	406
Figure B.4.30. Design plot of <i>dd</i> (pooled fatigue tests).....	406
Figure B.4.31. Design plot of <i>lnstif</i> (regression: coarse).	407
Figure B.4.32. Design plot of <i>lnnf</i> (regression: coarse).....	407
Figure B.4.33. Design plot of <i>aa</i> (regression: coarse).	408
Figure B.4.34. Design plot of <i>bb</i> (regression: coarse).	408
Figure B.4.35. Design plot of <i>cc</i> (regression: coarse).....	409
Figure B.4.36. Design plot of <i>dd</i> (regression: coarse).	409

Figure B.4.37. Boxplots for factor <i>ac</i> (regression: coarse).....	410
Figure B.4.38. Boxplots for factor <i>av</i> (regression: coarse).....	410
Figure B.4.39. Boxplots for factor <i>temp</i> (regression: coarse).....	411
Figure B.4.40. Boxplots for factor <i>stn</i> (regression: coarse).....	411
Figure B.4.41. Boxplots for factor <i>rs4s50</i> (regression: coarse).....	412
Figure B.4.42. Boxplots for factor <i>m200</i> (regression: coarse).....	412
Figure B.4.43. Boxplots for factor <i>sa</i> (regression: coarse).....	413
Figure B.4.44. Boxplots for factor <i>vma</i> (regression: coarse).....	413
Figure B.4.45. Boxplots for factor <i>vfa</i> (regression: coarse).....	414
Figure B.4.46. C_p plot for the model selection of initial stiffness (coarse).....	414
Figure B.4.47. Residual plots for the regression model of initial stiffness (coarse).....	415
Figure B.4.48. C_p plot for the model selection of fatigue life (coarse).....	415
Figure B.4.49. Residual plots for the regression model of fatigue life (coarse).....	416
Figure B.4.50. Design plot of <i>lnstif</i> (regression: fine).....	416
Figure B.4.51. Design plot of <i>lnnf</i> (regression: fine).....	417
Figure B.4.52. Design plot of <i>aa</i> (regression: fine).....	417
Figure B.4.53. Design plot of <i>bb</i> (regression: fine).....	418
Figure B.4.54. Design plot of <i>cc</i> (regression: fine).....	418
Figure B.4.55. Design plot of <i>dd</i> (regression: fine).....	419
Figure B.4.56. C_p plot for the model selection of initial stiffness (fine).....	419
Figure B.4.57. Residual plots for the regression model of initial stiffness (fine).....	420
Figure B.4.58. C_p plot for the model selection of fatigue life (fine).....	420
Figure B.4.59. Residual plots for the regression model of fatigue life (fine).....	421

Figure B.4.60. Design plot of <i>lnstif</i> (regression: fine-plus).....	421
Figure B.4.61. Design plot of <i>lnnf</i> (regression: fine-plus).....	422
Figure B.4.62. Design plot of <i>aa</i> (regression: fine-plus).....	422
Figure B.4.63. Design plot of <i>bb</i> (regression: fine-plus).....	423
Figure B.4.64. Design plot of <i>cc</i> (regression: fine-plus).....	423
Figure B.4.65. Design plot of <i>dd</i> (regression: fine-plus).....	424
Figure B.4.66. C_p plot for the model selection of initial stiffness (fine-plus).....	424
Figure B.4.67. Residual plots for the regression model of initial stiffness (fine-plus).....	425
Figure B.4.68. C_p plot for the model selection of fatigue life (fine-plus).....	425
Figure B.4.69. Residual plots for the regression model of fatigue life (fine-plus).....	426
Figure B.4.70. Design plot of <i>lnstif</i> (regression: fine and fine-plus).....	426
Figure B.4.71. Design plot of <i>lnnf</i> (regression: fine and fine-plus).....	427
Figure B.4.72. Design plot of <i>aa</i> (regression: fine and fine-plus).....	427
Figure B.4.73. Design plot of <i>bb</i> (regression: fine and fine-plus).....	428
Figure B.4.74. Design plot of <i>cc</i> (regression: fine and fine-plus).....	428
Figure B.4.75. Design plot of <i>dd</i> (regression: fine and fine-plus).....	429
Figure B.4.76. C_p plot for the model selection of initial stiffness (fine and fine-plus).....	429
Figure B.4.77. Residual plots for the regression model of initial stiffness (fine and fine-lus)..	430
Figure B.4.78. C_p plot for the model selection of fatigue life (fine and fine-plus).....	430
Figure B.4.79. Residual plots for the regression model of fatigue life (fine and fine-plus).....	431
Figure B.6.1. Simulation result of crack initiation for WesTrack Section 5 (coarse, AV = 8.1 %, AC = 5.63 %).	431

Figure B.6.2. Simulation result of crack initiation for WesTrack Section 6 (coarse, AV = 10.8 %, AC = 5.71 %).	432
Figure B.6.3. Simulation result of crack initiation for WesTrack Section 7 (coarse, AV = 6.9 %, AC = 6.49 %).	432
Figure B.6.4. Simulation result of crack initiation for WesTrack Section 23 (coarse, AV = 4.9 %, AC = 5.79 %).	433
Figure B.6.5. Simulation result of crack initiation for WesTrack Section 24 (coarse, AV = 7.2 %, AC = 5.94 %).	433
Figure B.6.6. Simulation result of crack initiation for WesTrack Section 25 (coarse, AV = 3.7 %, AC = 6.55 %).	434
Figure B.6.7. Simulation result of crack initiation for WesTrack Section 26 (coarse, AV = 11.0 %, AC = 5.31 %).	434
Figure B.6.8. Simulation result of crack initiation for WesTrack Section 1 (fine, AV = 8.8 %, AC = 5.35 %).	435
Figure B.6.9. Simulation result of crack initiation for WesTrack Section 2 (fine, AV = 10.4 %, AC = 4.92 %).	435
Figure B.6.10. Simulation result of crack initiation for WesTrack Section 3 (fine, AV = 12.4 %, AC = 4.97 %).	436
Figure B.6.11. Simulation result of crack initiation for WesTrack Section 4 (fine, AV = 6.6 %, AC = 5.12 %).	436
Figure B.6.12. Simulation result of crack initiation for WesTrack Section 14 (fine, AV = 9.0 %, AC = 6.05 %).	437

Figure B.6.13. Simulation result of crack initiation for WesTrack Section 15 (fine, AV = 8.7 %, AC = 5.42 %).	437
Figure B.6.14. Simulation result of crack initiation for WesTrack Section 16 (fine, AV = 12.2 %, AC = 4.75 %).	438
Figure B.6.15. Simulation result of crack initiation for WesTrack Section 17 (fine, AV = 11.0 %, AC = 5.74 %).	438
Figure B.6.16. Simulation result of crack initiation for WesTrack Section 18 (fine, AV = 4.3 %, AC = 6.04 %).	439
Figure B.6.17. Simulation result of crack initiation for WesTrack Section 9 (fine-plus, AV = 3.9 %, AC = 6.56 %).	439
Figure B.6.18. Simulation result of crack initiation for WesTrack Section 10 (fine-plus, AV = 11.8 %, AC = 5.28 %).	440
Figure B.6.19. Simulation result of crack initiation for WesTrack Section 11 (fine-plus, AV = 7.9 %, AC = 5.99 %).	440
Figure B.6.20. Simulation result of crack initiation for WesTrack Section 12 (fine-plus, AV = 4.6 %, AC = 5.84 %).	441
Figure B.6.21. Simulation result of crack initiation for WesTrack Section 13 (fine-plus, AV = 5.9 %, AC = 6.51 %).	441
Figure B.6.22. Simulation result of crack initiation for WesTrack Section 19 (fine-plus, AV = 7.2 %, AC = 5.89 %).	442
Figure B.6.23. Simulation result of crack initiation for WesTrack Section 20 (fine-plus, AV = 10.9 %, AC = 5.88 %).	442

Figure B.6.24. Simulation result of crack initiation for WesTrack Section 21 (fine-plus, AV = 4.2 %, AC = 6.75 %)	443
Figure B.6.25. Simulation result of crack initiation for WesTrack Section 22 (fine-plus, AV = 8.1 %, AC = 5.23 %)	443
Figure B.7.1. Image-and-contour plots of SR of WesTrack Section 1 after 21,943 hours of simulation with a correction factor of 1.0: (a) wander and (b) no wander.	444
Figure B.7.2. Image-and-contour plots of SR of WesTrack Section 2 after 21,943 hours of simulation with a correction factor of 1.0: (a) wander and (b) no wander.	445
Figure B.7.3. Image-and-contour plots of SR of WesTrack Section 4 after 21,943 hours of simulation with a correction factor of 1.0: (a) wander and (b) no wander.	446
Figure B.7.4. Image-and-contour plots of SR of WesTrack Section 14 after 21,943 hours of simulation with a correction factor of 1.0: (a) wander and (b) no wander.	447
Figure B.7.5. Image-and-contour plots of SR of WesTrack Section 15 after 21,943 hours of simulation with a correction factor of 1.0: (a) wander and (b) no wander.	448
Figure B.7.6. Image-and-contour plots of SR of WesTrack Section 16 after 21,943 hours of simulation with a correction factor of 1.0: (a) wander and (b) no wander.	449
Figure B.7.7. Image-and-contour plots of SR of WesTrack Section 17 after 21,943 hours of simulation with a correction factor of 1.0: (a) wander and (b) no wander.	450
Figure B.7.8. Image-and-contour plots of SR of WesTrack Section 18 after 21,943 hours of simulation with a correction factor of 1.0: (a) wander and (b) no wander.	451
Figure B.7.9. Image-and-contour plots of SR of WesTrack Section 9 after 21,943 hours of simulation with a correction factor of 1.0: (a) wander and (b) no wander.	452

Figure B.7.10. Image-and-contour plots of SR of WesTrack Section 10 after 21,943 hours of simulation with a correction factor of 1.0: (a) wander and (b) no wander.	453
Figure B.7.11. Image-and-contour plots of SR of WesTrack Section 11 after 21,943 hours of simulation with a correction factor of 1.0: (a) wander and (b) no wander.	454
Figure B.7.12. Image-and-contour plots of SR of WesTrack Section 12 after 21,943 hours of simulation with a correction factor of 1.0: (a) wander and (b) no wander.	455
Figure B.7.13. Image-and-contour plots of SR of WesTrack Section 13 after 21,943 hours of simulation with a correction factor of 1.0: (a) wander and (b) no wander.	456
Figure B.7.14. Image-and-contour plots of SR of WesTrack Section 19 after 21,943 hours of simulation with a correction factor of 1.0: (a) wander and (b) no wander.	457
Figure B.7.15. Image-and-contour plots of SR of WesTrack Section 20 after 21,943 hours of simulation with a correction factor of 1.0: (a) wander and (b) no wander.	458
Figure B.7.16. Image-and-contour plots of SR of WesTrack Section 21 after 21,943 hours of simulation with a correction factor of 1.0: (a) wander and (b) no wander.	459
Figure B.7.17. Image-and-contour plots of SR of WesTrack Section 22 after 21,943 hours of simulation with a correction factor of 1.0: (a) wander and (b) no wander.	460
Figure B.7.18. Image-and-contour plots of SR of WesTrack Section 5 after 21,943 hours of simulation with a correction factor of 1.0: (a) wander and (b) no wander.	461
Figure B.7.19. Image-and-contour plots of SR of WesTrack Section 6 after 21,943 hours of simulation with a correction factor of 1.0: (a) wander and (b) no wander.	462
Figure B.7.20. Image-and-contour plots of SR of WesTrack Section 7 after 21,943 hours of simulation with a correction factor of 1.0: (a) wander and (b) no wander.	463

Figure B.7.21. Image-and-contour plots of SR of WesTrack Section 23 after 21,943 hours of simulation with a correction factor of 1.0: (a) wander and (b) no wander.	464
Figure B.7.22. Image-and-contour plots of SR of WesTrack Section 24 after 21,943 hours of simulation with a correction factor of 1.0: (a) wander and (b) no wander.	465
Figure B.7.23. Image-and-contour plots of SR of WesTrack Section 25 after 21,943 hours of simulation with a correction factor of 1.0: (a) wander and (b) no wander.	466
Figure B.7.24. Image-and-contour plots of SR of WesTrack Section 26 after 21,943 hours of simulation with a correction factor of 1.0: (a) wander and (b) no wander.	467
Figure E.1. Module relationship of <i>Weibull</i> program.	498
Figure E2. Flow chart of <i>Weibull</i> main program.	502
Figure E3. Flow chart of the <code>process_one_hour ()</code> subroutine.	503
Figure E.4. “Node-by-node” and “hour-by-hour” algorithm of <i>Weibull</i> program.	504
Figure E.5. Weibull curves for fine-plus gradation at temperature 5°C.	510
Figure E.6. Weibull curves for fine-plus gradation at temperature 20°C.	510
Figure E.7. Weibull curves for fine-plus gradation at temperature 30°C.	511
Figure E.8. Weibull regression fitting and real data for fine-plus gradation.	514
Figure E.9. Weibull accelerated failure time model with different correction factors.	517
Figure E.10. Illustration of tensile strain calculation with wander.	519
Figure E.11. Relationship between initial stiffness and stiffness ratio.	521
Figure E.12. Plot of traditional flexural frequency sweep test at various reference temperatures.	522
Figure E.13. Using a uniform distribution $U(0,1)$ to generate a set of random numbers with a given distribution function.	526

Figure E.14. Assignment of random numbers to the nearest discrete number.	526
Figure E.15. Loading configuration, pavement structure, and ELSYM5 input of WesTrack for Weibull simulation.....	537
Figure E.16. Image-and-contour plot of stiffness ratio after the last application of traffic loading of example 1 with wander.....	538
Figure E.17. Image-and-contour plot of stiffness ratio after the last application of traffic loading of example 1 with no wander.....	538
Figure E.18. Stiffness deterioration curves at offset 14 in. and depth 5.99 in. for both wander and no-wander cases for example 1.....	539
Figure E.19. Image-and-contour plot of stiffness ratio after the last application of traffic loading of WesTrack (example 2: with wander).....	540
Figure E.20. Image-and-contour plot of stiffness ratio after the last application of traffic loading of WesTrack (example 2: with no wander).....	541
Figure E.21. Stiffness deterioration curves for example 2.....	542

LIST OF TABLES

Table 3.1 WesTrack Original Construction Gradations and Laboratory-mixed and Laboratory-compacted Gradations.....	57
Table 3.2 Laboratory Test Plan and Test Purpose.....	61
Table 4.1 Covariates Investigated in Chapter 4	76
Table 4.2 Summary Statistics of WesTrack Fatigue Tests.....	93
Table 4.3 Model Selection of Stiffness and Fatigue Life of the WesTrack Project.....	109
Table 4.4 Final Regression Models of Stiffness and Fatigue Life of the WesTrack Project	110
Table 4.5 Summary Statistics of Weibull Coefficients	112
Table 4.6 Associated Figures and Tables for Regression Analysis	113
Table 4.7 Mix Properties for the Varied-strain Fatigue Test	127
Table 4.8 Mix Properties for the Varied-temperature Fatigue Test	140
Table 5.1 Temperature Susceptibility Fatigue Test Results of WesTrack Fine-plus Gradation	168
Table 5.2 Pavement Structure for Mode Factor Simulation.....	199
Table 6.1 Recording and Analysis Periods of WesTrack Project	208
Table 6.2 Sample Sizes of Fatigue Tests for Various Gradations.....	223
Table 6.3a Results of Regression Coefficients m_1 of Coarse Mixes at Different Temperature Gradient Intervals.....	236
Table 6.3b Results of Regression Coefficients m_2 of Coarse Mixes at Different Temperature Gradient Intervals.....	236
Table 6.3c Results of Regression Coefficients σ of Coarse Mixes at Different Temperature Gradient Intervals.....	237

Table 6.3d Results of Regression Coefficients A of Coarse Mixes at Different Temperature Gradient Intervals.....	237
Table 6.4a Results of Regression Coefficients m_1 of Fine and Fine-plus Mixes at Different Temperature Gradient Intervals	238
Table 6.4b Results of Regression Coefficients m_2 of Fine and Fine-plus Mixes at Different Temperature Gradient Intervals	238
Table 6.4c Results of Regression Coefficients σ of Fine and Fine-plus Mixes at Different Temperature Gradient Intervals	239
Table 6.4d Results of Regression Coefficients A of Fine and Fine-plus Mixes at Different Temperature Gradient Intervals	239
Table 6.5 Summary Table of Fatigue Performance Prediction and Condition Survey Data of WesTrack	246
Table 7.1 Mix Properties of the WesTrack Project as the Input of Weibull Simulation	268
Table 7.2 Final SR of Weibull Simulation of the WesTrack Project.....	280
Table 7.3 Condition Survey Data of Fatigue Cracking and Simulation Results.....	286
Table 7.4 Percentage Reduction of Air-Void Contents of WesTrack after 9 Months of Traffic Loading.....	310
Table 7.5 Decomposition of Correction Factor.....	337
Table A.4.1 Fatigue Rest Results and Weibull Regression Fits at 20°C	368
Table A.4.2 WesTrack Temperature Susceptibility Fatigue Test Results and Weibull Regression Fits at Various Temperatures (Field-mixed and Field-compacted)	373
Table A.4.3 WesTrack Temperature Susceptibility Fatigue Test Results and Weibull Regression Fits at Various Temperatures (Laboratory-mixed and Laboratory-compacted).....	374

Table A.4.4 High Temperature Fatigue Test Results and Weibull Regression Fits	375
Table A.4.5 Fatigue Test Results and Weibull Regression Fits with Various Gradation Types	376
Table A.4.6 Correlation Matrix of Fatigue Tests at 20°C.....	377
Table A.4.7 Correlation Matrix of Temperature Susceptibility Fatigue Tests (Field-mixed and Field-compacted)	378
Table A.4.8 Correlation Matrix of Temperature Susceptibility Fatigue Tests (Laboratory-mixed and Laboratory-compacted)	379
Table A.4.9 Correlation Matrix of High Temperature Fatigue Tests	380
Table A.4.10 Correlation Matrix of Fatigue Tests with Various Gradation Types.....	381
Table A.4.11 Correlation Matrix of Pooled Fatigue Tests	382
Table A.4.12 Correlation Matrix of Coarse Gradation.....	383
Table A.4.13 Correlation Matrix of Fine Gradation.....	384
Table A.4.14 Correlation Matrix of Fine-plus Gradation.....	385
Table A.4.15 Correlation Matrix of Fine and Fine-plus Gradations	386
Table A.4.16 Range of Covariates and Response Variables of Various Fatigue Tests.....	387
Table A.4.17 Range of Covariates and Response Variables of Various Gradation Types	388
Table E.1. Temperature Susceptibility Fatigue Test Results of WesTrack Fine-plus Gradation.....	509
Table E.2 The Time-varied Distributions of Wander, Ttraffic Composition, and Vehicle Speed	524

INTRODUCTION

1.1 Background

“High Temperature Fatigue” has long been identified as an important phenomenon that limits the lifetime of metallic components in mechanical engineering applications. However, little has been studied in the field of asphalt concrete under these conditions. The lack of popular attention to this matter might be attributed to the “common wisdom” that fatigue cracking occurs at an intermediate temperature of around 20°C, whereas when the temperature rises above 40°C or higher, the distress mode of asphalt concrete is predominated by the rutting mechanism, i.e., the asphalt concrete tends to flow out as viscoelastic materials do at high temperatures. The fatigue tests used by many researchers (e.g., Monismith, Deacon, Epps, Tayebali, and Harvey) to generate fatigue life regression equations have been conducted at temperatures ranging only from 5°C to 30°C.

In 1995, the WesTrack project, sponsored by the Federal Highway Administration (FHWA) and headed by the Nevada Automotive Test Center, was to continue to develop the asphalt aggregate mix performance-related specifications prepared in earlier studies (Kennedy 1994, Witczak 1997) and to validate the Superpave Mix design method. A 2.9-km oval track with 26 test sections was built to evaluate the effect of variations in binder content, gradation, and density on the Superpave Design system. Pavement temperatures were recorded hourly at different depths of the pavement structure from March 1996 to October 1998. During the trafficking of the test section, the proportion of temperatures above 30°C at the bottom of the asphalt concrete layer was about 20 percent of the total recorded time. Serious fatigue cracking had been observed within some test sections. The realities of fatigue distress and the high temperature found at the bottom of asphalt concrete have motivated the study of “high

temperature fatigue” conducted herein to verify the existence of fatigue damage in asphalt concrete at the elevated temperatures.

Based on the high temperature distribution and the observed fatigue distress that occurred at WesTrack, three questions come to mind: (1) How much of the fatigue distress occurs at high temperatures? (2) How does the temperature affect the fatigue damage process? and (3) Does high temperature have a more deleterious effect in terms of fatigue damage than does low temperature?

This study of fatigue at high temperatures has been limited to a temperature range of 30°C to 40°C. The conventional repetitive simple shear test at constant height is usually conducted at temperatures higher than 40°C because very little permanent shear deformation is developed below 40°C. Using the conventional fatigue testing machine and methodology, it is very difficult to obtain the fatigue response at a temperature higher than 30°C. Most mixes will creep and sag during the installation and during testing. As a result, it is almost impossible to conduct a controlled-strain fatigue beam test.

Monismith et al. (1985) have suggested a relationship of fatigue life as a function of maximum tensile strain and initial mix stiffness,

$$N_f = A(1/\varepsilon_t)^a (1/S_{mix})^b \quad (1.1)$$

where:

- ε_t = tensile strain,
- S_{mix} = initial mix stiffness,
- N_f = fatigue life, and

A, a, and b are experimentally determined coefficients.

From Figure 1.1a, it will be noted that the fatigue life at a specified strain level decreases as the stiffness of the mix increases. In Equation 1.1, the ε_t and S_{mix} are the functions of temperature (as shown in Figures 1.1b and 1.1c). In other words, the fatigue equation can then

be transferred as a function of temperature (as shown in Figure 1.1d). It should be noted that the fatigue life as a function of temperature depends highly on the rate change of ϵ_t and S_{mix} , especially at high temperatures. The magnitude of the fatigue life depends on the interaction between the effect of the temperature on the rate change of S_{mix} contributed to the term $(1/S_{mix})^b$ and the effect of the temperature on the rate change of ϵ_t contributed to the term $(1/\epsilon_t)^a$. Hence, it is worthwhile to study the fatigue response at an elevated temperature.

Figure 1.2 displays an image-contour plot of the computed maximum tensile strains occurring in a pavement structure under the load application of dual tires. This simulation case assumes a 35°C bottom temperature and a positive temperature gradient that is defined as $(T@150mm - T@50mm)/100mm$; in other words, the pavement temperature near the surface is lower than that found at the bottom of the asphalt concrete layer. The calculations of maximum tensile strain were based on a layered-elastic program named Circly (Wardle 1977). From the results, it can be observed that the maximum tensile strain occurred at the bottom of the asphalt concrete layer.

A designed traffic pattern, i.e., the wander pattern, was applied on the WesTrack track. As a result of the wander pattern and environmental factors, the pavement experienced a compound-strain loading history. The following question then is how to apply the laboratory simple fatigue test results to describe the cumulative fatigue damage caused by the compound-strain loading history.

It should be noted that the WesTrack pavement was designed to accumulate about ten million 80-kN (18-kip) equivalent single axle loads (ESALs) in two years with fatigue cracking occurring for the average construction quality conditions originally planned. It was found that

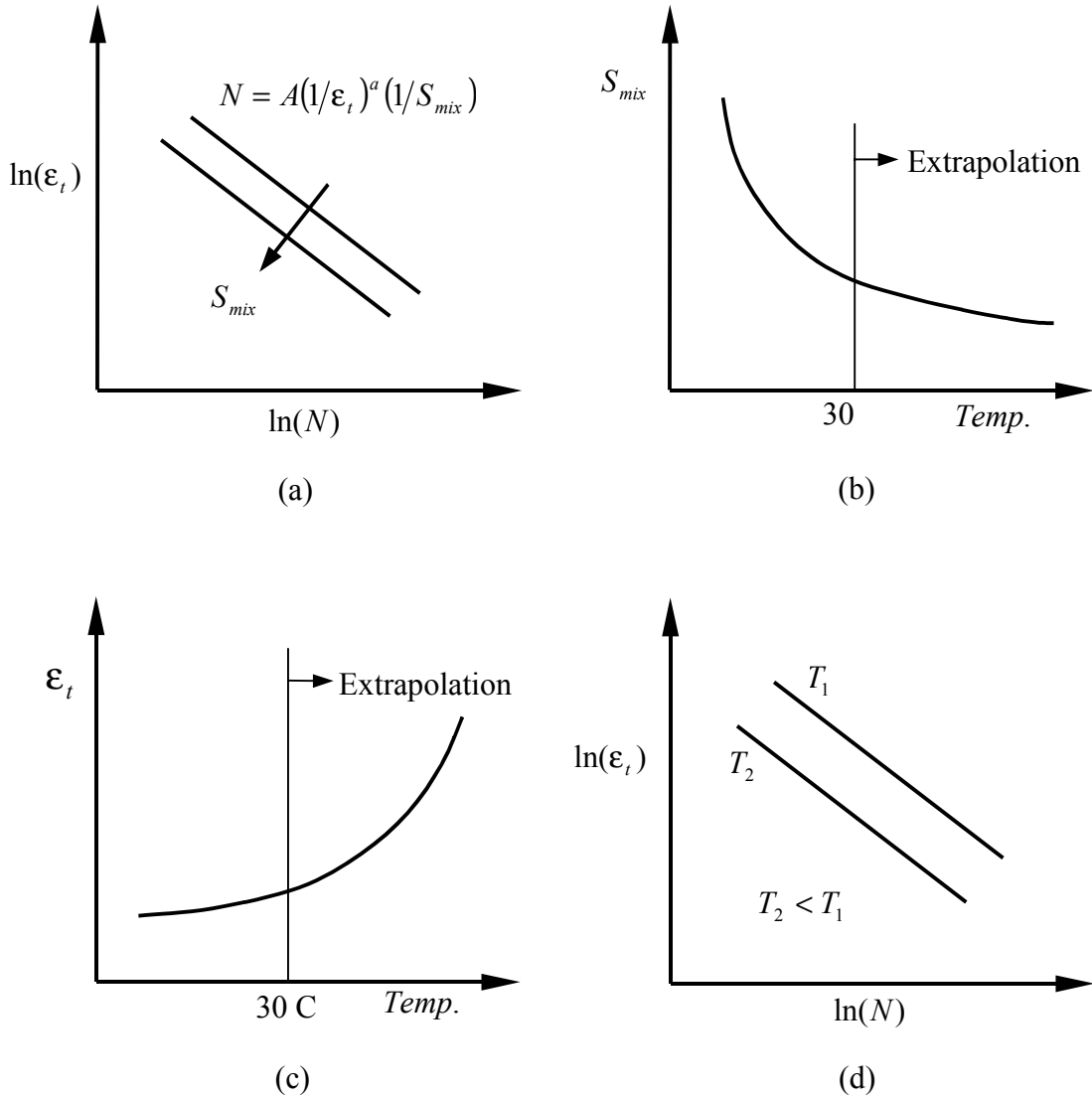

Figure 1.1. (a) Fatigue life versus strain with various stiffnesses; (b) and (c) stiffness and tensile strain as a function of temperature; (d) fatigue life versus strain with various temperatures.

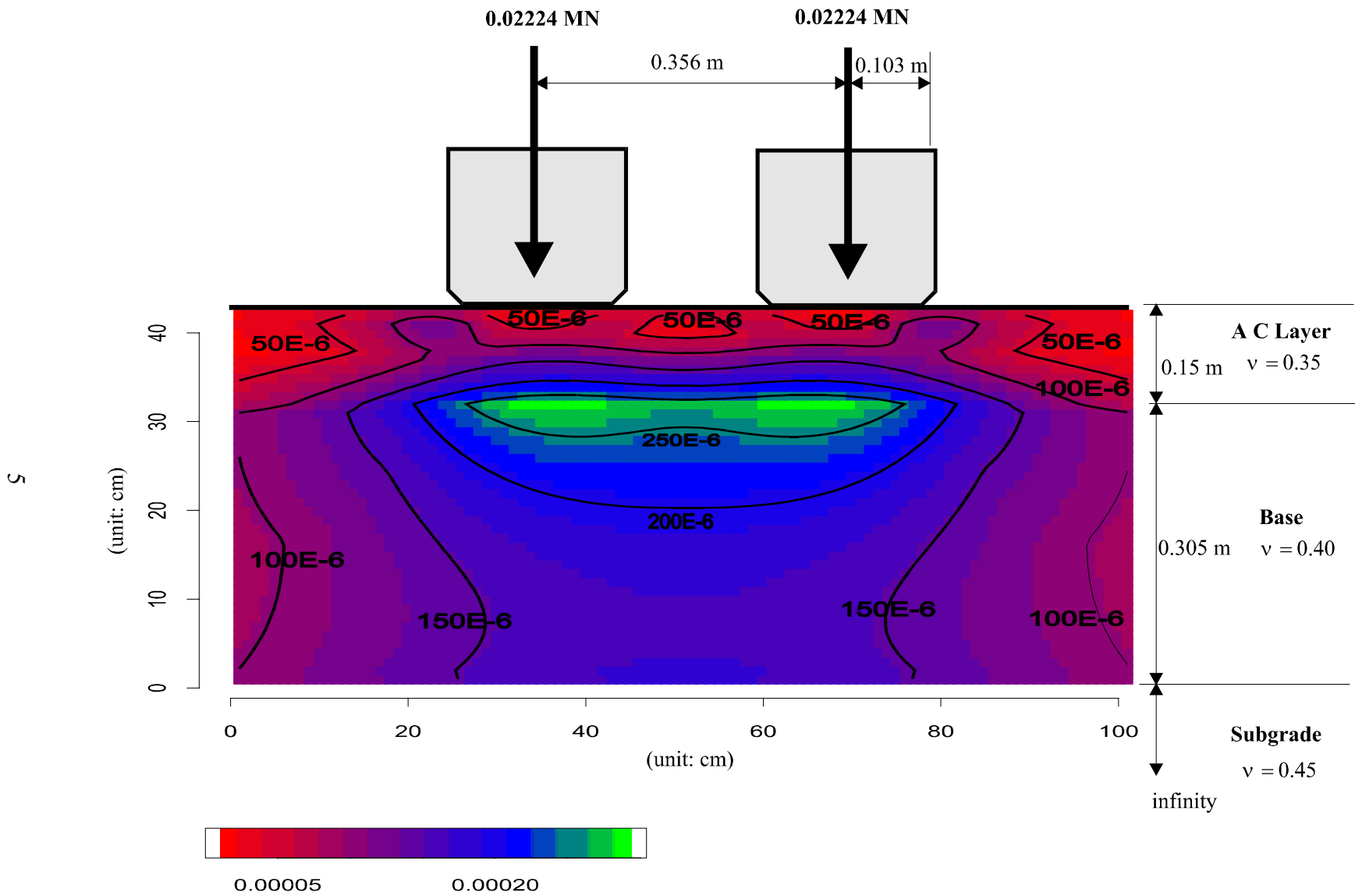

Figure 1.2. Image-and-contour plot of the maximum tensile strains of pavement with a dual-tire traffic load (simulation case: $T_b = 35^\circ\text{C}$, temperature gradient = 0.06).

several sections deteriorated much faster than should be expected. During the WesTrack project, there were two winters, hence it was suspected that the cold weather accelerated the crack propagation for those sections seriously cracked. To explore the possible reasons for the deterioration, it is very important to fully understand the fatigue damage process experienced by the asphalt concrete under the combination effect of material, traffic and environmental factors. Within the context of this study, the term “stiffness deterioration process” is the synonym of the term “fatigue damage process” because the stiffness ratio is utilized as an index of the fatigue damage.

1.2 Research Objectives

The scope and the objectives of this project were to:

- Explore the fatigue behavior of asphalt concrete subjected to high temperatures, defined as the range of 30°C to 40°C.
- Explore the use of the Weibull proportional hazards model to describe the stiffness deterioration process of asphalt concrete subjected to various material and testing variables and to use this model in the Weibull dynamic approach to predict fatigue performance.
- Determine whether it is possible to predict the fatigue performance, especially the crack initiation, of real pavement in laboratory simple fatigue tests through the introduction of the Weibull dynamic approach and hence to improve and specify the performance-oriented mix design which will ensure longer service life with economy.
- Provide an affordable and feasible computer program based on the developed Weibull dynamic approach to simulate the fatigue performance with the input of traffic and

temperature spectra, laboratory fatigue test results, and pavement structure. In doing so, it might be expected to accelerate the efficiency of pavement design and reduce the extensive amount of computation effort required to an acceptable level.

- Identify and subdivide the correction factor, conventionally recognized as “shift factor”, into several sub-correction factors which are related to mix properties, traffic wander, temperature, rest periods, crack propagation time, and boundary conditions of pavement structure. In addition, potential correction factors related to traffic composition and vehicle speed are also discussed.

1.3 Literature Review

1.3.1 History of Asphalt Concrete Fatigue Model Development

Fatigue cracking is one of the three major modes of distress considered in pavement design. The other two modes are permanent deformation and thermal cracking, which are beyond the scope of this study. Investigation by Hveem (1955) demonstrated the concept that fatigue cracking has a higher propensity to occur on the pavement when the pavement experiences a larger deflection and a higher loading frequency. This work had an impact on developing laboratory fatigue tests to describe the phenomenon of fatigue failure. Accordingly, two equations (Monismith et al. 1971, Pell 1973) were developed to define the fatigue response of asphalt concrete as shown in the following:

$$N_f = A(1/\epsilon_t)^B \quad (1.2)$$

or

$$N_f = C(1/\sigma_t)^D$$

where

- N_f = number of repetitions to failure,
 - ϵ_t = tensile strain repeatedly applied,
 - σ_t = tensile stress repeatedly applied, and
- A, B, C, and D are experimentally determined coefficients.

Monismith et al. (1985) proposed a more applicable formula for the fatigue life, already shown in Equation 1.1. This equation was used in the Shell (1978 and 1985) and the Asphalt Institute (1981) design procedures. The coefficients were determined by considering the amount of cracking, mix type, and the thickness of the asphalt-bound layer. Following the development of this laboratory fatigue relationship, Deacon (1965) demonstrated the applicability of a cumulative fatigue damage hypothesis by using it to consider the development of damage resulting from a range in strains. This relationship is termed the linear summation of cycle ratios, or Miner's Law (1945). Miner's hypothesis for cumulative fatigue damage has been widely used to predict fatigue cracking. The hypothesis is stated as follows,

$$\sum_{i=1}^n \frac{n_i}{N_i} \leq 1 \quad (1.3)$$

where

- n_i = number of actual traffic load applications at strain level i ,
- N_i = number of allowable traffic load applications at strain level i .

Fatigue failure is defined as when the linear summation of cycle ratios reaches one. It is assumed that the fatigue failure is independent of loading sequence. Monismith et al. (1987) proposed an analytically-based approach to predict the fatigue life and stressed that the tensile strains on the underside of an asphalt concrete layer must be calculated for the expected range of traffic loads, materials, and environmental conditions.

Van der Poel (1954) first referred to a loosely defined (not shear, bulk, elastic, or complex) quotient of stress and strain as the stiffness. Monismith (1969) reinforced van der

Poel's concept, stating that the time of loading and temperature must be well defined when the term stiffness is used. This indicates that the stiffness of aggregate-asphalt mixes is a relative quantity rather than an absolute quantity and the term is meaningful only when the temperature and loading time are specified.

The work done by Deacon (1965) and Epps (1968) has contributed significantly to identifying the factors in pavement design that affect fatigue performance and minimize fatigue cracking. Finn and Epps (1980) indicated the possible causes of fatigue cracking as structural deficiency, excessive air voids, change in properties of asphalt with time, aggregate gradation, stripping, construction considerations, and drainage. Harvey and Tsai (1996) also showed that the air-void content and asphalt content have significant effects on the fatigue performance of asphalt concrete.

An alternative approach to a strain-based fatigue analysis in pavement design is to utilize the concept of dissipated energy. This concept can be traced to the work done by van Dijk et al. (1972) on thin bitumen films. Van Dijk (1975) and van Dijk and Visser (1977) extended the concept to the fatigue of bituminous mixes. The dissipated energy was recognized as a leading factor in fatigue analysis, particularly of viscoelastic material, by Pronk and Hopman (1990). Van Dijk and Visser (1977) reported the following energy relationship which is independent of test method, testing conditions, loading frequency, or rest periods:

$$W_{FAT} = A(N_{FAT})^Z \quad (1.4)$$

where

N_{FAT} = the load repetitions to fatigue failure

W_{FAT} = the total dissipated energy per unit volume obtained by summation for

$i = 1$ to N_{FAT} , i.e., $W_{FAT} = \sum_{i=1}^{N_{FAT}} W_i$; A and Z are experimentally determined and mix-dependent.

To relate this energy relationship obtained from the laboratory to the pavement structure, it is necessary to calculate the dissipated energy that occurs in a pavement structure under traffic load. It is possible to compute the dissipated energy by using a dynamic algorithm, such as is found in the program SAPSI (Sousa et al. 1988, Chen 1987).

In the Strategic Highway Research Program (SHRP) project A-003, Tayebali et al. (1994) also proposed an energy-dependent surrogate fatigue model:

$$N_f = A \cdot \exp(B \cdot VFB) \cdot (w_0)^C \quad (1.5)$$

where

N_f = fatigue life,
 w_0 = initial dissipated energy per cycle, psi,
 VFB = percent voids filled with bitumen, and
 A and B are experimentally determined coefficients.

The strain-based fatigue analysis mainly utilizes Equation 1.1 and Miner's Law (Equation 1.3). Equation 1.4 is the primary relationship used for the energy-based fatigue analysis. Both of these approaches have long been used in evaluating pavement fatigue design, yet neither approach considers information on the fatigue damage before pavement failure.

1.3.2 Crack Initiation and Crack Propagation

Conventionally, the term fatigue is used to mean tensile fatigue rather than shear fatigue in pavement engineering. In this regard, the fatigue resistance of an asphalt mix is defined as the capacity to prevail against repeated bending without fracture. Fatigue failure manifests itself in the form of cracking that consists of a series of interconnecting cracks on the pavement surface caused by repeated traffic loading. Fatigue cracking occurs at places of high tensile strain or at locations with high tensile stress concentrations in the asphalt concrete layer.

In general, fatigue can be described as a two-phase process, i.e., a crack initiation process followed by a crack propagation process. In places where a high tensile strain repetitively occurs in the asphalt concrete, microcracks start to initiate. Hence, a lost area, where the microcracks develop, increases gradually as a result of the accumulating microcracks. Consequently, the tensile stress increases relatively and causes the development of macrocracks. Majidzadeh et al. (1971) postulated that the fatigue life of asphalt mixes could be described by three processes: damage initiation, growth, and final failure. Therefore, the fatigue life could be represented accordingly by the following form:

$$N_f = f(c_0, (A, n, K), K_C)$$

In this equation, c_0 is associated with the process of crack initiation and considered as the “starter flaw” from which the crack will propagate. The (A, n, K) set expresses the process of crack growth and is the parameters of the Paris equation (Paris 1964): $\frac{dc}{dN} = AK^n$, where K is the stress intensity factor and A and n are the material constants. K_C is the critical stress-intensity factor, which is proportional to the critical strain energy release rate and Young’s modulus. Both notched and un-notched specimens were utilized to determine these constants. Salam and Monismith (1972) also conducted a series of fracture tests using notched specimens and examined the tensile fracture characteristics of asphalt mixes using the Paris equation.

Little et al. (1997) asserted that the mechanisms of crack initiation and propagation should be governed by the same Paris law. This crack-based fatigue analysis differs markedly from the phenomenological-and-statistical fatigue analysis as discussed in this report.

However, some fatigue performance models have defined the crack initiation as the first appearance of longitudinal, transverse, or alligator cracks of a minimum length of 0.5 m under

the wheel paths. Accordingly, several models have been proposed such as the PARIS model (1999), and the HDM-4 model (1997). Ullidtz (1987) proposed a progressive way to predict the crack propagation time in the Mathematical Model of Pavement Performance (MMOPP).

However, it should be noted that the study of crack propagation is not included in this report.

Huang (1993) also pointed out a finding of the AASHO Road Test: “more surface cracking occurred during periods when the pavement was in a relatively cold state than during periods of warm weather.” His statement suggests the possibility that cold weather actually favors the crack propagation phenomenon.

It was found that the fatigue failure that occurred at WesTrack was from the bottom layers up to the surface, justifying further study of the prediction of this “bottom-up” type of cracking. As illustrated in Figure 1.3 repetitive trafficking loads cause both tensile and shear strains to occur on or near the surface and mainly tensile strains at the bottom of the asphalt layer. Once the accumulated fatigue damage exceeds the fatigue-resistant capacity of the asphalt layer, the crack initiation develops and the crack starts to propagate. It might be conjectured that the propagation is accelerated by the shrinkage of the asphalt layer in a cold winter and the tensile strain caused by the temperature drop.

1.3.3 High Temperature Fatigue Test

The examination of “high temperature fatigue” within the context of this study is limited to a temperature range of 30°C to 40°C. Pell (1963) reported a set of fatigue test results of asphalt mixes, as illustrated in Figure 1.4, containing tests conducted from -9.5°C to 40°C and showing that the fatigue life at a given strain level is seen to increase as the temperature increases.

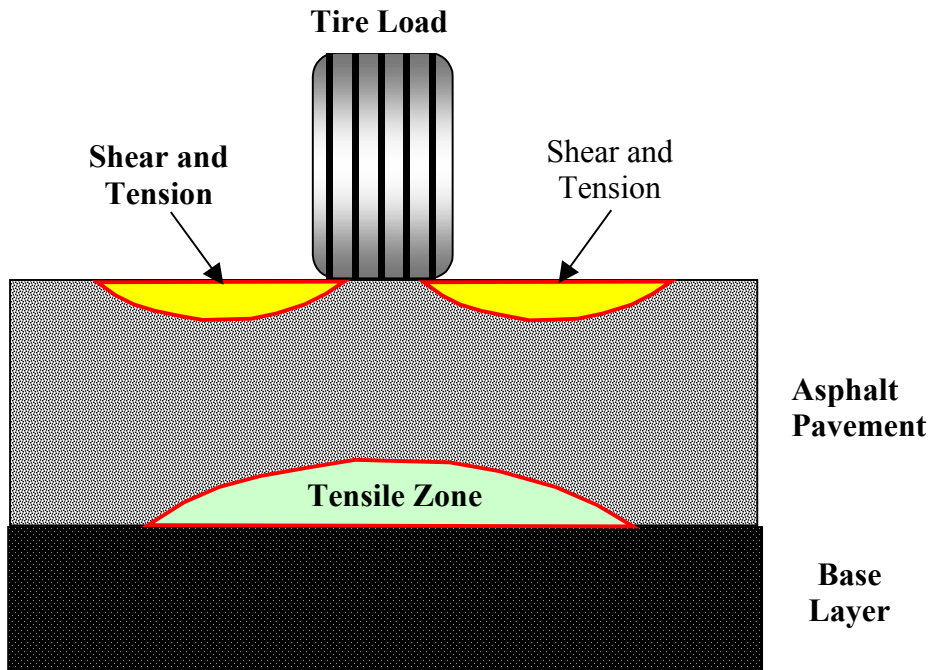

(a) Crack Initiation

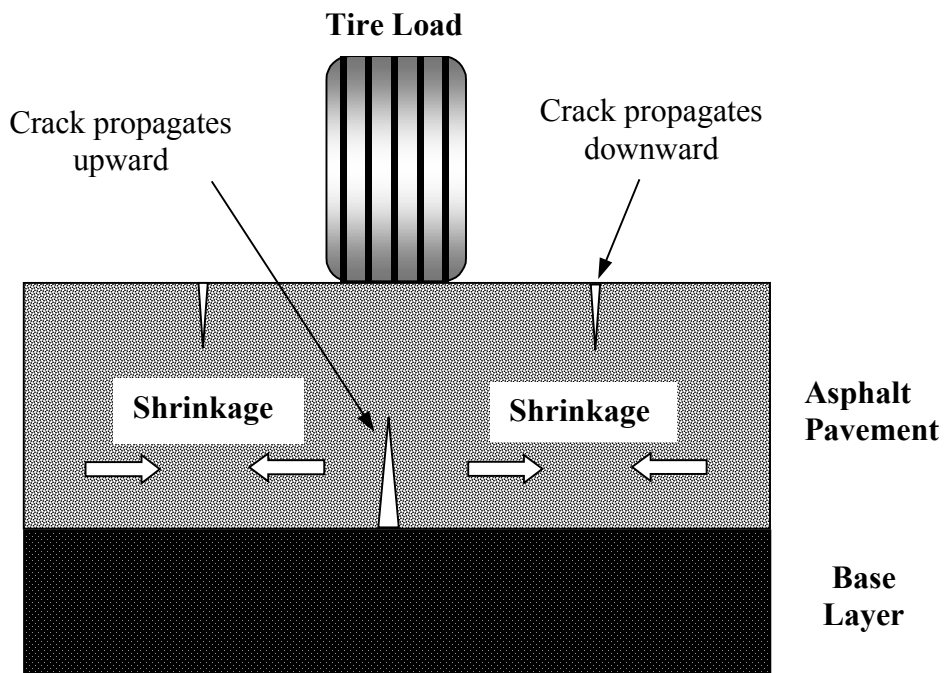

(b) Crack Propagation

Figure 1.3. Crack initiation and crack propagation.

Hofstra and Valkering (1972) concluded that, “elastic theory can be used to describe the behavior of flexible pavements subjected to moving wheels even at the highest temperatures that are likely to be experienced in pavements.” They measured the stresses and strains imposed by a moving wheel load using the laboratory test track and then compared the results with the theoretical results from the BISTRO computer program (Peutz et al. 1968). The temperatures of test pavements were varied from 20°C to 60°C.

Raithby and Sterling (1972) conducted direct cyclic tensile and compressive fatigue tests with a constant stress on a specimen sawed from a “rolled carpet” with a loading consisting of sinusoidal loading and various rest periods at three test temperatures: 10°C, 25°C, and 40°C. The relation of rest period to the fatigue performance at various temperatures was the major concern of this paper. A life ratio, defined as the ratio of the mean life to failure with rest periods to the mean life under continuous cycling (no rest periods) for the same cyclic stress conditions, was used to estimate the rest period effect. From these findings (as shown in Figure 1.5) it can be concluded that: (1) the life ratios were not significantly different at 10°C and 25°C; (2) the life ratios at 10°C and 25°C were about 5 to 6 times larger than those at 40°C for the rest periods greater than 0.2 seconds; (3) the rest periods resulted in a longer fatigue life; and (4) the application of test results with no rest periods would seriously underestimate the fatigue performance of the in-situ condition that has rest periods. In addition to their findings of how fatigue life is affected by rest periods, Raithby and Sterling also found that rest periods affect the dynamic stiffness. When rest periods are included, the dynamic stiffness falls rapidly initially, as is the case without rest periods; thereafter the change of stiffness is much more gradual than in the case without rest periods.

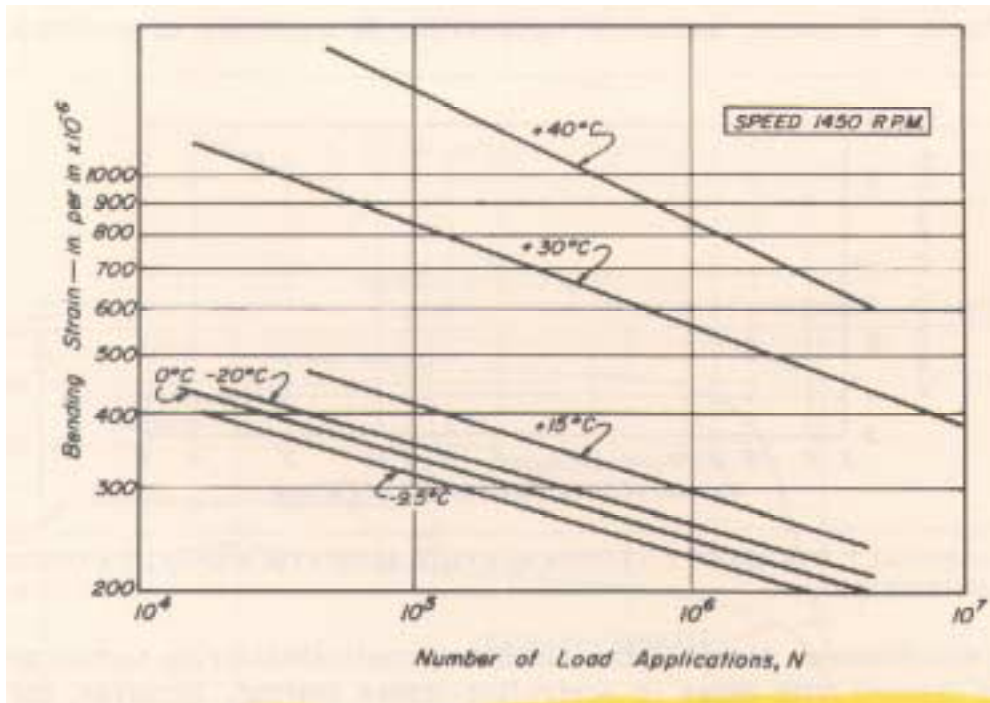

Figure 1.4. Controlled-strain fatigue diagram (after Pell).

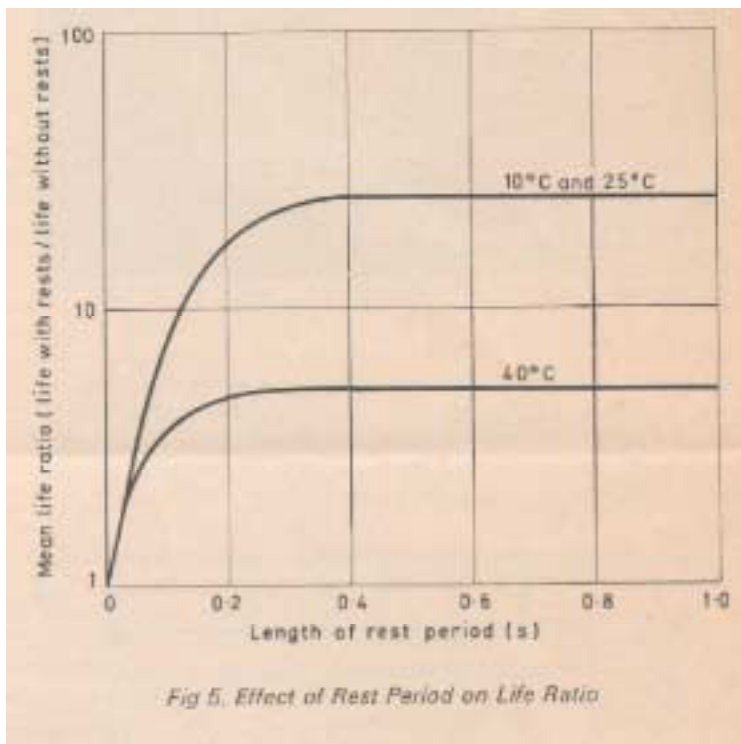

Fig 5. Effect of Rest Period on Life Ratio

Figure 1.5. Effect of rest period on life ratio (after Raithby).

From Figure 1.5, it can be seen that the life ratios at 10°C and 25°C were about 5 to 6 times larger than those at 40°C for rest periods greater than 0.2 second. This observation contradicts the understanding that the healing of asphalt concrete at high temperatures should elongate the fatigue life.

It is suspected that the early quick drop in stiffness in a laboratory fatigue test is due in part to the test beam moving to a temperature equilibrium after a 2 to 3°C temperature increase from energy dissipation (Pronk 1996).

1.3.4 Compound Strain-Based Fatigue Loading

The ultimate goal of conducting laboratory fatigue tests is to predict the in-situ pavement fatigue performance. From the point of view of a strain-based analysis, it is recognized that compound fatigue loading always exists in the pavement as caused by the combination of traffic and environmental factors. Usually, a simple fatigue test (same deformation or load, temperature, load duration, rest period) is conducted in the laboratory. Therefore, it is important to comprehend the fatigue damage process of compound fatigue loading using the simple fatigue test results. Monismith, et al. (1975) reported that neither the “time-hardening” and the “strain-hardening” procedures used in calculating the permanent deformation, as illustrated in Figure 1.6, provided a solution that agreed quantitatively with the experimental results. Ullidtz (1987) used the strain-hardening procedure to calculate the permanent strain in the MMOPP model. Although it seems that the strain-hardening and the time-hardening are usually applied in calculating the permanent deformation, in this study the feasibility of applying these two procedures to the fatigue damage process in terms of stiffness ratio will be evaluated.

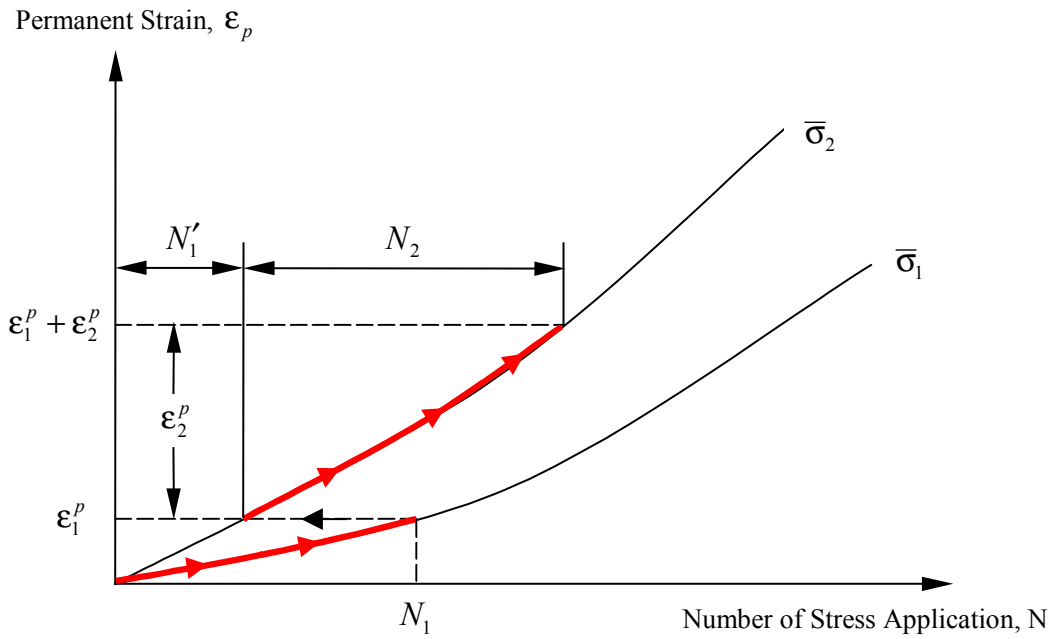

(a) Time Hardening Procedure

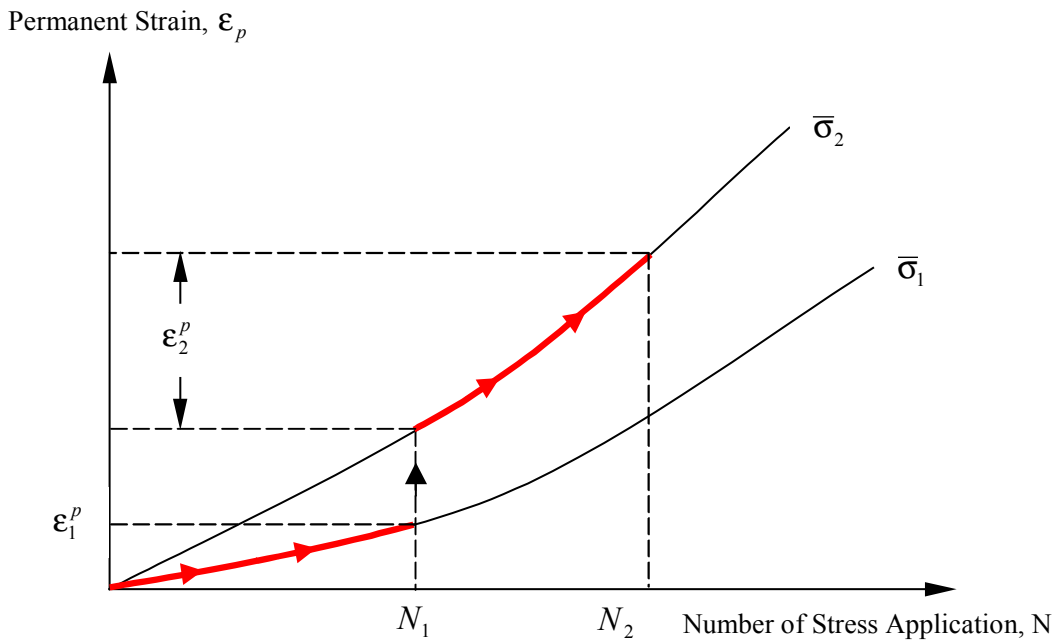

(b) Strain Hardening Procedure

Figure 1.6. Procedures to predict cumulative loading from results of simple loading test (after Monismith 1975).

Actually, this compound strain loading is pertinent to the microscopic mechanism of how the stiffness deterioration process behaves under various temperature or environmental factors; therefore it is very important to further confirm this mechanism in the future.

1.3.5 The Weibull Function

In the late 1930s, Weibull introduced his ideas about the statistical distributions of material strength with the publication of two important papers: “A Statistical Theory of the Strength of Materials” (Weibull 1939a) and “The Phenomenon of Rupture in Solids” (Weibull 1939b). Since then, the Weibull function and the Weibull distribution have found wide application in many fields. However, there has been little application of the Weibull function in describing the fatigue damage process in asphalt concrete. Garcia-Diaz, A. (1984) developed several performance models using an “S-shaped” survivor curve, instead of a Weibull survivor function, for predicting pavement performance in terms of three indices, present serviceability index, distress area index, and the distress severity index. Little et al. (1997) suggested that a microcrack length distribution can be described as a Weibull distribution with the following form:

$$p(c) = \lambda\gamma(\lambda c)^{\gamma-1} \exp(-(\lambda c)^\gamma)$$

where

- c = microcrack length,
- γ = a shape parameter, and
- λ = a scale parameter.

The parameters were further assumed to change with load repetitions. This crack-based approach is an alternative way to inspect the fatigue damage.

1.3.6 Cumulative Fatigue Damage Prediction

Cumulative fatigue damage theory is usually referred to by Miner's Law, shown in Equation 1.3. Actually, Palmgren (1924) first introduced the hypothesis of cumulative fatigue damage for the testing of ball bearings. However, it was Miner (1945) who advanced a similar proposal and made it more popular for his testing of aluminum alloy specimens. Two aspects of this Palmgren-Miner hypothesis should be mentioned: (1) the accumulation of fatigue damage is assumed to be linear and equal to one at failure, and (2) The required number of loads to fail and the applied number of loads are obtained in terms of stress level instead of strain level. It is generally agreed that the allowable number of load repetitions is related to the tensile strain at the bottom of the asphalt concrete layer. Deacon (1965) proposed the linear summation of cycle ratios (sometimes referred to as Miner's hypothesis) to determine the cumulative fatigue damage using strain-based test results. However, Ioannides (1997) inspected the Miner's hypothesis and found evidence in the literature suggesting the concepts of cumulative damage theory should be abandoned.

A specific phenomenological probabilistic model, namely the B-model, of cumulative damage of fatigue, fatigue crack growth, and wear was published in Bogdanoff's book (1985). In addition to this probabilistic model, Oh (1991) characterized the fatigue life of specimens with variable amplitude loads by using a nonlinear cumulative damage model.

Many researchers (e.g., Croney 1990, Ullidtz 1987, Wang and Larson 1978), from their studies on experimental and in-service pavements, found that there is a significant relationship between long-term pavement performance and changes in the transition deflections of the pavement surface. In a model of long-term pavement performance, i.e., MMOPP, Ullidtz (1987) characterized the aforementioned relationship as a reduction in the elastic modulus of the asphalt concrete with progressive fatigue damage. Collop (1994) also indicated that it is important to

consider the modulus degradation mechanism in pavement design, and that it should be included in calculations when predicting long-term flexible pavement performance. Ullidtz (1998) asserted that, “the interaction of structural damage, climate effects, aging and traffic loading may accelerate the deterioration.”

1.3.7 Full-Scale Accelerated Pavement Tests

Metcalf (1996) gives us this definition of full-scale accelerated pavement tests: “the controlled application of a prototype wheel loading, at or above the appropriate legal load limit to a prototype or actual, layered, structural pavement system to determine pavement response and performance under a controlled, accelerated, accumulation of damage in a compressed time period.”

As pointed out by Monismith (1992), the following four historical events had significant influence before 1962, the recognized starting point of analytically based design: (1) early work done by Burmister (1945), (2) the development of the Benkelman beam during the WASHO Road Test (1954 and 1955), (3) the research on pavement deflection and fatigue failure by Hveem (1955), and (4) the AASHO Road Test (1962)

The most important concept of the AASHO test (1962) that was performed in the early 1960s in Illinois was that the damaging effect of the passage of an axle load can be represented by a number of 18-kip equivalent single axle loads (ESALs). Huang (1993) stated that, “one important contribution of the AASHO Road Test was the development of the pavement serviceability concept together with the equations relating serviceability, load, and thickness design of both flexible and rigid pavements.”

Dai (1997) inspected the test results from the Mn/Road project and found that the linear elasticity assumption seems to be acceptable when calculating the peak strains in the bottom of

an asphalt concrete layer at an average temperature of up to 40°C. Additionally, it was found that the peak strain in the bottom of the pavement continuously decreased as the truck speed increased on a smooth pavement. However, for a relatively rough pavement, the strain decreased as the truck speed increased up to about 65 km/hr, then strain started to increase when the speed further increased from 65 up to 103 km/hr, which could be attributed to the dynamic load. Therefore, the higher vehicle speed results in less loading time and thus decreases the tensile strain level at the bottom of the pavement.

Sebaaly et al. (1989) demonstrated that most of the stiffness of asphalt-bound layers may be lost when cracking appears on the surface of the pavement. They determined the modulus of asphalt concrete using the Falling Weight Deflectometer (FWD) data during a FHWA experiment with the Accelerated Loading Facility (ALF).

Recently, Kim and Kim (1997) used the technology named Spectral Analysis of Surface Waves (SASW) to decide the modulus of asphalt concrete related to the number of load applications. Accordingly, several findings of pavement deterioration have been summarized by them: (1) a rather rapid deterioration rate, during which one third of the initial stiffness is lost. This is then followed by a much slower deterioration rate to a final level of about 15-20 percent of initial stiffness, (2) the first appearance of cracking was observed at about 70 percent stiffness deduction, and (3) a rapid increase in cracking occurred at about 80 percent stiffness deduction.

1.3.8 Shift Factor

Within the context of this study, the term “correction factor” rather than shift factor is used, for it is recognized that the shift factor is actually affected by a host of correction factors that account for wander, mix properties, boundary conditions, temperature conditions, pavement structure, crack propagation, and the trafficking load. To apply the laboratory fatigue test results

to predict in-situ fatigue performance, it is necessary to apply a shift factor. A shift factor of 10 means that the damage to a test beam caused by one repetition is equivalent to the same damage caused by 10 load repetitions as accumulated in an asphalt pavement.

A large variety of shift factors can be expected, owing to the differences in material properties, test methods, field conditions, pavement structure, and structure models. Pell (1987) indicated that the shift factor might range from 5 to 700. Deacon et al. (1994) in the SHRP A-003 studies recommended a shift factor ranging from 10 to 14 depending on the amount of surface cracking that can be tolerated. Many shift factors have been proposed by the Asphalt Institute, the Shell design method, Thompson (1987), Powell et al. (1984), and Verstraeten et al. (1982). One commonality is that all these shift factors relate the hot mix asphalt (HMA) tensile strain to the allowable number of load repetitions. Finn et al. (1977) showed that a shift factor of about 13 was required for laboratory fatigue test results to match the fatigue performance of the AASHO Road Test. Raithby and Sterling (1970) demonstrated that rest periods of a uniaxial tensile cyclic test would affect the fatigue lives by a factor of 5 or more as compared with the specimen tested without rest periods. Gerritsen and Koole (1987) suggested a shift factor ranging from 5 to 25 (including the considerations of the rest periods between the loads, lateral distribution of the wheel loads and the temperature gradient in the asphalt layer) should be multiplied to the laboratory-derived fatigue criterion to meet the in-situ fatigue performance. In recent studies, Harvey et al. (1997) also proposed a strain-based shift factor for use in a reliability-based mix design system for mitigating fatigue distress as seen in Figure 1.7.

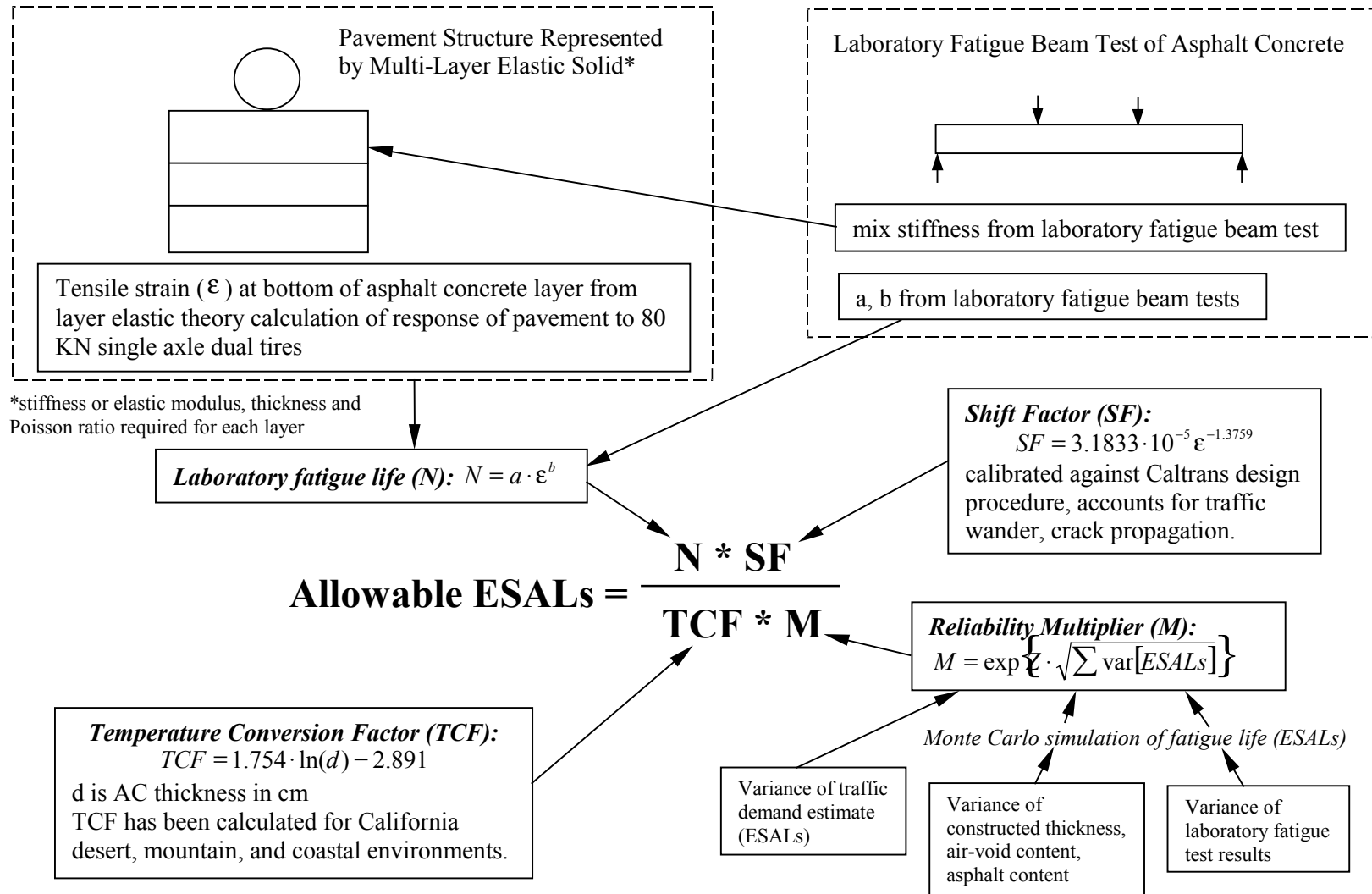

Figure 1.7. Methodology followed in the fatigue analysis system to determine ESALs (after Harvey 1997).

Several findings from the above literature review are summarized in the following:

- Historically, the various conventional fatigue approaches and models do not take into consideration the entire fatigue damage process, only the end points of crack initiation and propagation.
- It seems to be acceptable to apply the linear layered-elastic programs, e.g., Circlly or ELSYM5 (Ahlborn 1972), based on the linear elasticity assumption in calculating the strains of pavement structure at high temperatures.
- The fatigue cracking appearing on the surface of an asphalt concrete pavement is caused not only by the crack initiation but more importantly by the crack propagation that is mostly attributed to the cyclic thermal strain and shrinkage as well.
- Caution should be exercised in applying the results of simple fatigue tests, either in controlled-strain or controlled-stress loading modes, to interpreting the cumulative fatigue damage caused by compound loading.
- Full-size accelerated pavement testing provides an effective but expensive way to validate the correction factors needed for applying the laboratory fatigue test results to predict fatigue performance in field pavement.
- Stiffness deterioration of asphalt concrete must be considered in pavement design.

Keeping these facts in mind, a Weibull dynamic approach will be developed in this study.

In this approach, the fatigue damage process is described by using a two-parameter Weibull function. Furthermore, a Weibull proportional hazards model is adopted to represent all the material and environmental variables in one comprehensive regression equation. A Weibull accelerated failure time model is used to correct for the effect of boundary conditions between the laboratory and field. In conducting the simulation, it is presumed that the linear elastic

theory is appropriate at high temperatures. Hence, the linear layered-elastic program ELSYM5 will be used as the “strain engine” in computing the strains occurring inside the asphalt concrete layer.

1.4 Research Organization

This report is divided into 8 chapters, beginning with the Introduction. Chapter 2 provides a brief introduction of the available data resources from the WesTrack and CAL/APT HVS projects. The laboratory test plan is described in Chapter 3 to supplement the incompleteness of currently available data and explore the effects of environmental and material variables on the fatigue damage process. The specimen preparation is also described in detail in Chapter 3.

Chapter 4 contains a detailed analysis of laboratory fatigue test results performed for this study, including the identification of significant factors that affect the stiffness, fatigue life, and fatigue damage process, regression analysis of stiffness and fatigue life for various WesTrack mixes, and the exploration of a compound stiffness deterioration curve subjected to changes of strain level and temperature.

The theoretical derivation of a Weibull dynamic approach for predicting fatigue performance is described in Chapter 5, mainly containing the Weibull proportional hazards model and the Weibull accelerated failure time model. In addition, some discussion of the relation of predictions from Weibull and Miner’s Law is also included.

A methodology for simulating the fatigue performance of WesTrack based on the Miner’s approach is proposed in Chapter 6.

Chapter 7 contains the fatigue performance simulations utilizing the Weibull dynamic approach.

Several variables including traffic pattern, weather pattern, construction variability, and correction factor that affect the fatigue damage process are also inspected. Conclusions and perspectives are presented in Chapter 8.

2.0 DATA SOURCES

In keeping with the objectives discussed in Chapter 1, a primary task is to integrate the laboratory fatigue test results with the condition survey and field data by introducing the Weibull dynamic approach as well as several correction factors to correct the effects caused by, for instance, traffic wander, temperature variation, and boundary conditions. To achieve this goal, it is necessary not only to incorporate the laboratory test results with the field data but also to ensure that the laboratory tests can cover the data range encountered in the field. Accordingly, the laboratory test plan put forth in the next chapter is such that the test results obtained can further extend the currently existing database. This database is briefly discussed in the paragraphs to follow, as well as the WesTrack project, CAL/APT HVS project, and the laboratory fatigue tests associated with each of these projects.

2.1 WesTrack Project

WesTrack was a \$15 million full scale accelerated pavement testing facility sponsored by the FHWA of the U.S. Department of Transportation and the National Cooperation Highway Research Program (NCHRP), located approximately 100 kilometers southeast of Reno, Nevada. The test pavements were designed and constructed from October of 1994 to October of 1995.

The main objectives of the WesTrack project were to define the effects of construction variability on the asphalt mix performance, to further expand the performance-related specifications of aggregate-asphalt mixes that had been developed in the Strategic Highway Research Program (SHRP), and to validate the Superpave Mix Design method.

The papers and reports (e.g., WesTrack Team 1996, and Hand 1998) of the WesTrack project have been published and discussed in detail elsewhere. A brief summary of the WesTrack project is included here to provide a background understanding for the prediction of

fatigue performance based on the Miner's hypothesis and the Weibull dynamic approach presented in Chapters 6 and 7.

2.1.1 Track Characteristics

A 2.9-km oval track, constructed in November of 1995, consists of 26 test sections, as seen in Figure 2.1. As stated above, one of the objectives of WesTrack was to assess the construction variability of binder content, gradation, and density on performance using mixes designed according to the Superpave mix design system. To achieve this goal, mixes of three different aggregate gradations, termed *coarse*, *fine*, and *fine-plus*, each with three asphalt contents and air-void contents were arranged at various locations of track. Sections 5, 6, 7, 8, 23, 24, 25, and 26 were coarse mixes, sections 1, 2, 3, 4, 14, 15, 16, 17, and 18 were the fine mixes, and sections 9, 10, 11, 12, 13, 19, 20, 21, and 22 were the fine-plus mixes.

The pavement structure for these 26 original sections was all the same, consisting of an asphalt concrete layer of 6 inches (150 mm), a base layer of 12 inches (304 mm), and a subgrade layer. This identical pavement structure of the original WesTrack sections made it impossible to investigate the effect of pavement thickness on the fatigue performance. Because of failures, 9 sections were replaced in June 1997. However, only the originally constructed 26 sections are considered in the later simulation.

2.1.2 Mix Characteristics

The WesTrack coarse gradation was produced from partially crushed gravel and screenings. The WesTrack fine gradation was obtained from the same crushed material with additional local natural sands. The addition of 3 percent baghouse material, or material passing the 0.075 mm sieve, to the fine mix defined a fine-plus mix. All the mixes utilized a nominal

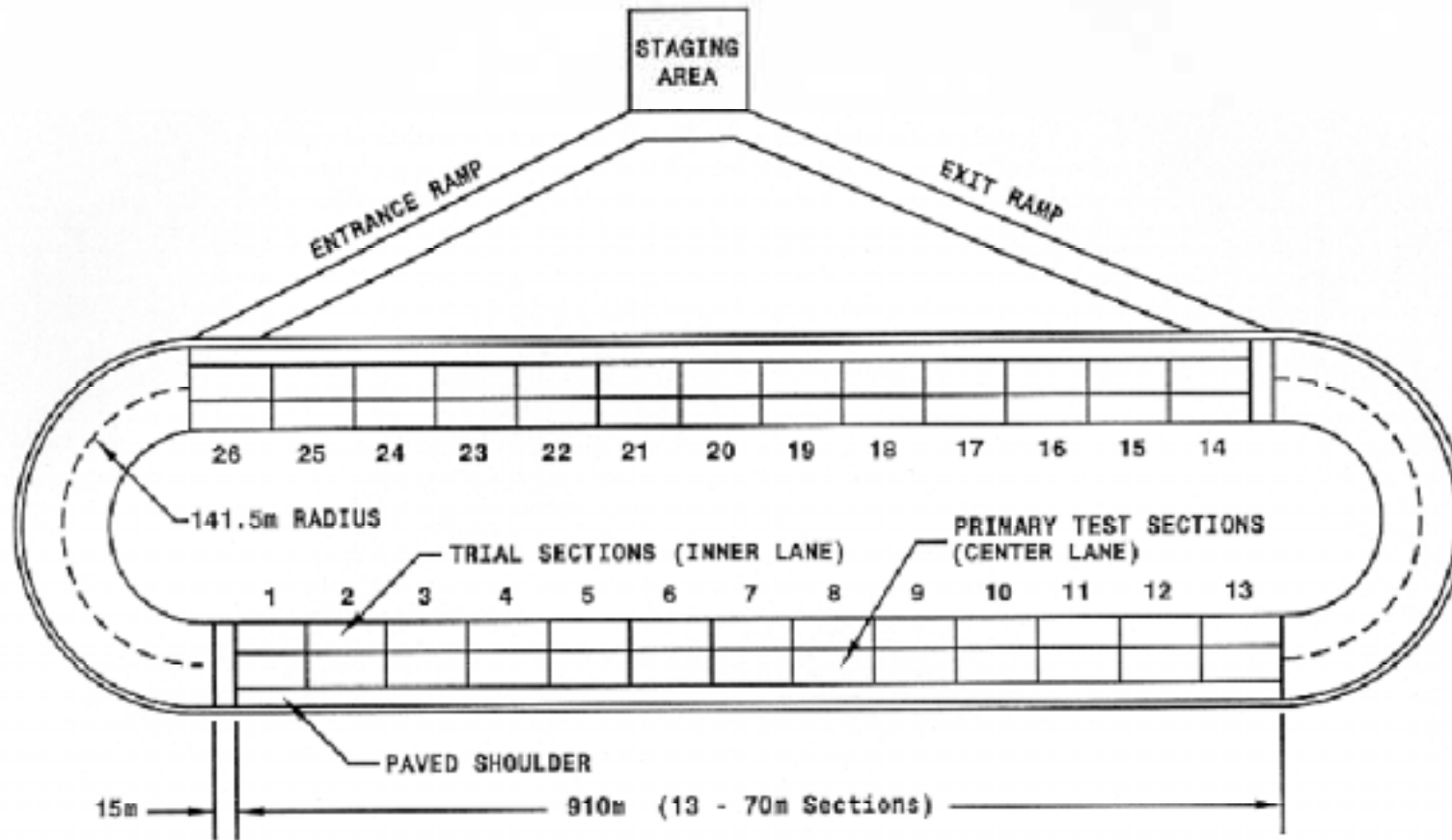

Figure 2.1. Layout of WesTrack test track (not to scale).

maximum aggregate size of 19 mm and used an unmodified PG 64-22 binder. According to the American Association of State Highway and Transportation Officials (AASHTO) specification MP-1 (1996), the binder will have appropriate properties to a high temperature of 64°C and a low temperature of -22°C.

The individual gradation curves of WesTrack are shown in Figure 2.2, which plots the percent passing against the 0.45 power of sieve size. As seen in this figure, the fine and fine-plus curves are plotted above the Superpave restricted zone and the maximum density line; the coarse curve is plotted below the Superpave restricted zone and the maximum density line. Notice that the fine-plus gradation is almost parallel shifted upward from the fine gradation curve. The same grading information is also plotted in terms of percent passing against the logarithm of sieve size as illustrated in Figure 2.3.

The aggregate gradation in the Superpave specification is controlled by two criteria (1) the control points and (2) the restricted zone, as shown in Figure 2.2. The control points form the master range through which the proposed trial blends must pass. It is recommended by the Superpave mix design method that the trial blends gradations not pass through the restricted zone to ensure that the trial blends do not have an excess of fine sand in relation to total sand. With these specifications, it is believed that a distribution of aggregate particle sizes can be developed to form a tough aggregate skeleton to resist rutting and maintain sufficient VMA (voids filled with aggregate) for durability.

2.1.3 Traffic

The trafficking load for the WesTrack project was generated by four autonomous (driverless) tractor/triple-trailer vehicles under an automated vehicle guidance system designed and installed in March 1996. For each truck, two two-single-axle trailers were towed and

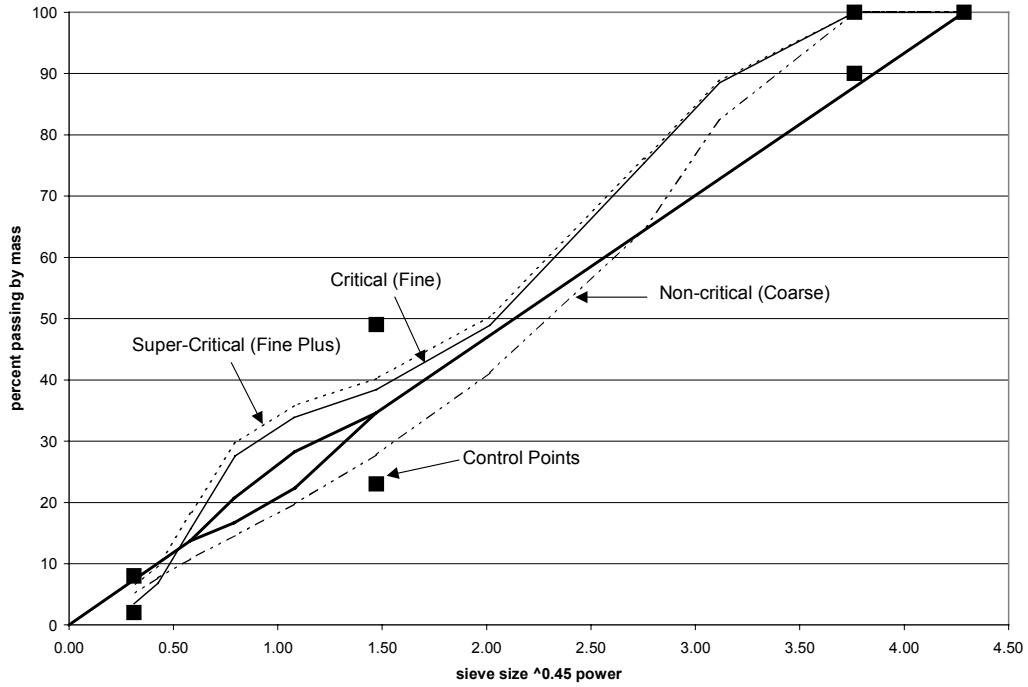

Figure 2.2. Individual WesTrack gradation curves on a 19-mm nominal size 0.45 power chart.

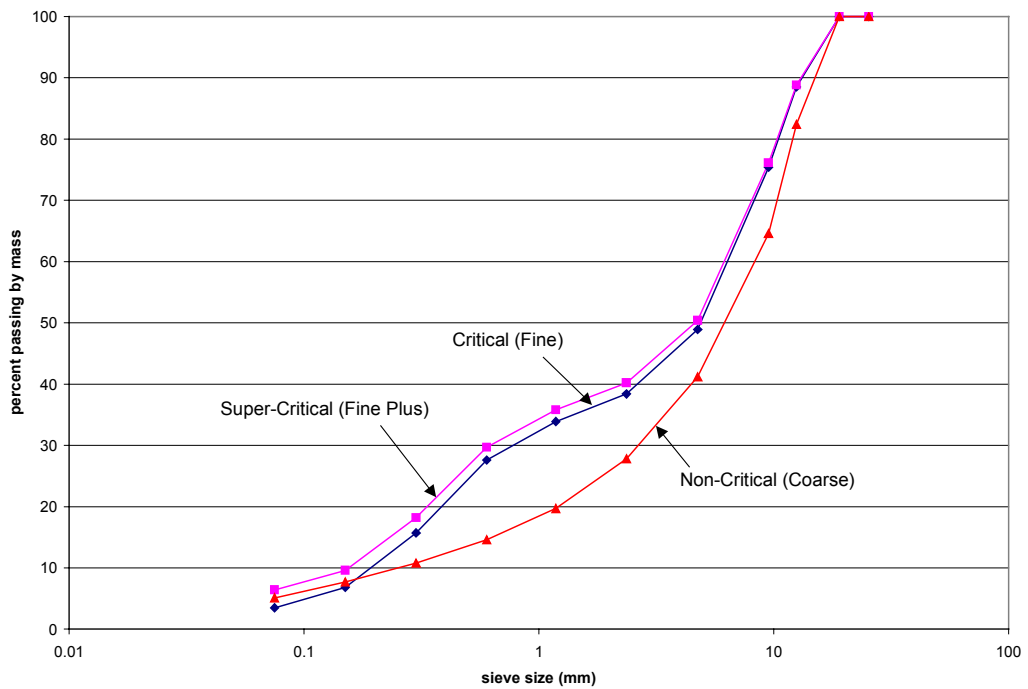

Figure 2.3. Individual WesTrack gradation curves on a semi-logarithmic chart.

attached to a typical 3-axle tractor/single-axle semi-trailer, as shown in Figure 2.4. In addition to the 54-kN load of the steering axle, each axle carried 89 kN. As a consequence, it resulted in the application of 10.5 ESALs with each truck pass. The 295/75R22.5 truck tires were inflated to 700 kPa (100 psi). The speed of the trucks was maintained at 64 kilometer per hour or 40 miles per hour. Ten million 80-kN (18-kip) equivalent single axle loads (ESAL) were planned to be applied to the pavements in two years. Accordingly, the WesTrack pavement structure was designed to serve this requirement.

The trafficking load of WesTrack was applied at 11 wander positions designated as 5L, 4L, 3L, 2L, 1L, CENTER, 1R, 2R, 3R, 4R, and 5R, where the “xL” stands for x inches to the left of central position and “yR” means y inches to the right of central position. In addition, a wander case named “OFF” was applied on the track at times. It means that the truck guiding system was shut off and the truck was manually maneuvered. When the trafficking loads were documented as being applied in the “OFF” situation, it was considered that the traffic was evenly distributed over the 11 wander positions because no recorded data were available in finding the real wander distribution of the “OFF” situation.

Instead of using ESAL as a simulation base, the load repetitions of an 89-kN axle load, resulting in 5000 lb. for each tire in a dual-tire setup, will be utilized in the simulation of fatigue performance. For this purpose, it is necessary to convert the ESAL-based traffic data into a repetition-based traffic data. As visualized in Figure 2.5, from a mechanical point of view, the truck configuration can be categorized into three types of load configurations: namely one 54-kN steering axle (two tires per axle), an 89-kN per axle tandem axle (four tires per axle and two axles), and an 89-kN single axle (four tires per axle and one axle) with dual tires. After inspecting the tensile strain calculated by the ELSYM5 program when subjected to several



Figure 2.4. Driverless triple-trailer test trucks.

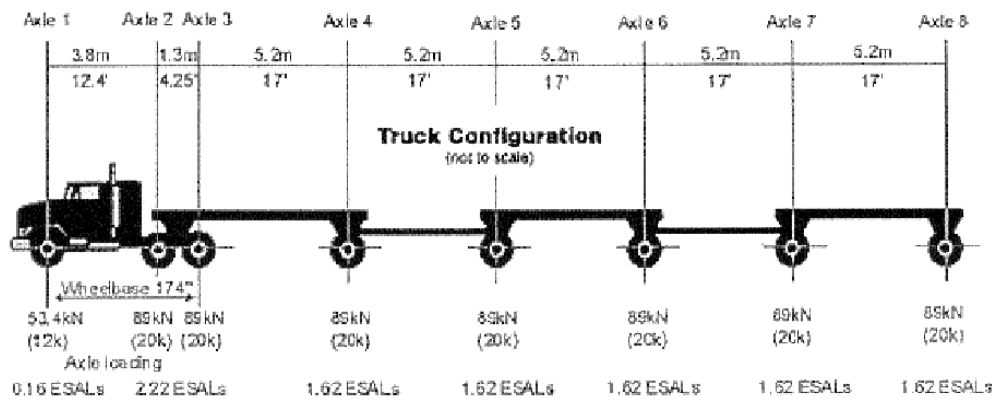

Figure 2.5. Tractor/trailer configuration.

environmental conditions, no distinct differences were perceived among the maximum tensile strains occurring at the bottom of the asphalt concrete layer for those three load configurations. The tandem is spaced far enough to behave like two singles. It was then decided to assume that the fatigue damage caused by each axle has the same effect. Since this truck configuration results in an application of 10.5 ESALs, a multiplication factor of 0.763 (8 axles divided by 10.5 ESALs) has been applied to convert the ESALs into load repetitions.

Inspection of the traffic data indicates that almost one-tenth of the traffic was applied on the track with very little wander, i.e., applied mostly at the central position. This is unrealistic as

compared to normal highway trafficking. This traffic pattern was later modified by the author so as to evaluate the wander effect caused by this specific WesTrack traffic pattern. It was observed at WesTrack that, likely due to the radial tires of the trucks, once the initial deformation (or rutting) was established in the wheel path, the following trailers, instead of following the guiding cab vehicle, tended to follow the initial ruts. Therefore, there were differences between the “documented and well-controlled” traffic data and the actual trafficking. The traffic data was recorded hourly according to the wander positions that apply.

2.1.4 Temperature

Temperature sensors for WesTrack were installed in sections 12, 19, and 25, and temperatures were recorded hourly. For each section, there were 18 sensors installed below the surface. Sensors 1 to 3 were placed in the AC layer at depths: 25.4, 76.2, and 127 mm, respectively. Another fifteen sensors were also placed at spacing of 18, 94, 172, 246, 322, 476, 627, 782, 933, 1087, 1240, 1392, 1544, 1696, and 1847 mm below the top of the base layer. It is the temperatures in the asphalt concrete layer that are of primary interest for this study. The pavement temperatures at 50 mm were obtained by interpolating the temperatures of sensors 1 and 2; the pavement temperatures at 150 mm were calculated by extrapolating from the temperatures of sensors 2 and 3. The temperature gradient, g , was defined based on the temperatures at these two depths and is expressed as $g = \frac{T_{50} - T_{150}}{100}$. It was found that the temperatures recorded from section 19 deviated somewhat from those recorded at sections 12 and 25. As the temperatures obtained from sections 12 and 25 were reasonably consistent, the representative pavement temperatures for WesTrack were determined utilizing the average temperatures of sections 12 and 25. An input file containing the pavement temperatures at 50

mm and 150 mm and the induced temperature gradients was utilized in the *Weibull* program to predict the fatigue performance as described later.

2.2 CAL/APT HVS Project

Since 1995, the California Department of Transportation (Caltrans) Accelerated Pavement Testing Program (CAL/APT) has used the Heavy Vehicle Simulator (HVS) technology, both in a controlled experimental setting at the University of California at Berkeley Richmond Field Station (RFS) and on selected field sites throughout California.

The primary intent to using the data from the CAL/APT HVS project is to verify the feasibility of applying the Weibull accelerated failure time model (described in Chapter 5) to estimate the correction factor caused by the differences of boundary conditions between laboratory tested specimens and asphalt pavement in the field. For this study, a back-calculation algorithm utilizing data from multi-depth deflectometer (MDD) measurements at Section 503RF was adopted to estimate stiffness deterioration with trafficking.

2.2.1 Section 503RF

Section 503RF was the fourth of four pavement test sections as part of Goal 1 of the CAL/APT Strategic Plan (Caltrans 1995). This section and the other three sections included in Goal 1 were designed and constructed according to Caltrans procedures. Section 503RF was a full-scale pavement containing an asphalt concrete pavement with a conventional aggregate base and was tested with the HVS at the RFS.

The primary objective of the Section 503RF test was to quantitatively verify existing Caltrans design methodology for the conventional aggregate base pavement pertinent to failure under repetitive trafficking at a moderate temperature, which was maintained at a level of $20 \pm$

3°C at the pavement surface. Thermocouples were utilized to record air and pavement temperatures; their installation positions are shown in Figure 2.6.

The pavement structure of Section 503RF, as seen in Figure 2.6, was designed to follow the specification of Caltrans procedures (Caltrans 1991), containing a dense-graded asphalt concrete surface, an untreated aggregate base and subbase and a clay subgrade. The design layer thicknesses of Section 503RF were 137 mm for asphalt concrete, 274 mm for aggregate base, and 229 mm for the aggregate subbase. It was found, however, from a few cores that the as-built thicknesses of the asphalt concrete layer and aggregate subbase were 162 mm and 305 mm respectively. Accordingly, the layer thicknesses used in the verification of the Weibull accelerated failure time model are the measured rather than the design thicknesses.

2.2.2 Trafficking Plan

The HVS trafficking of Section 503RF was started in March 1996 and completed in September 1996 with a total of more than 1.91×10^6 load repetitions. The trafficking plan of Section 503RF was conducted in three stages. A dual-wheel load of 40 kN was applied for the first 150,000 repetitions to avoid excessive initial deformation. In the second stage, a dual-wheel load of 80 kN was applied for 50,000 repetitions. After this, the dual-wheel load was increased to 100 kN and maintained at this level for the rest of test to accelerate pavement cracking. The HVS was programmed to simulate the wander over the 1-m width of the test section as happens on a normal highway with the bias-ply truck tires inflated to a pressure of 690 kPa (100 psi). Trafficking was bi-directional as opposed to uni-directional at WesTrack and in the field.

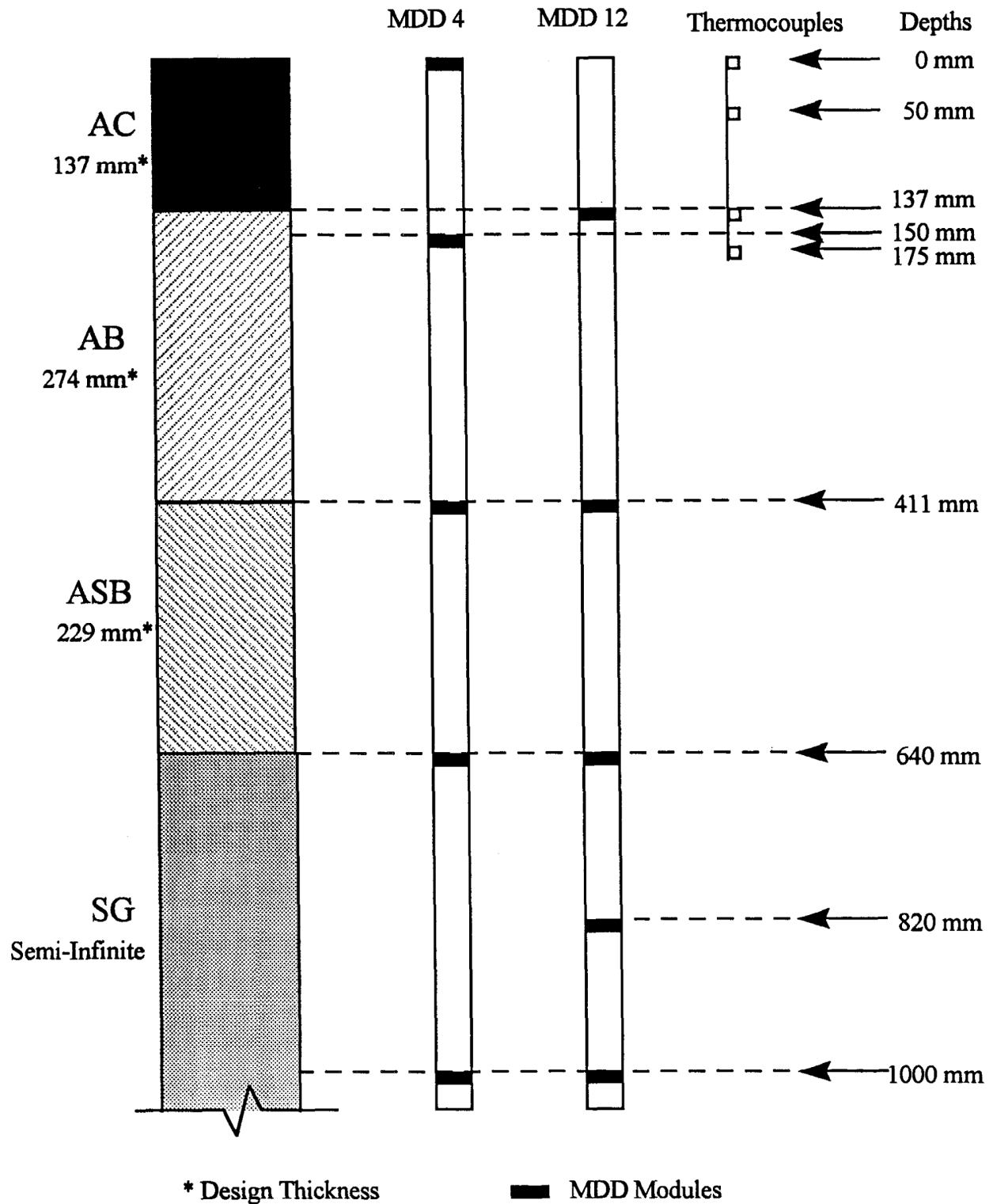

Figure 2.6. 503RF pavement structure with MDD and thermocouple positioning (after Harvey 1997).

2.2.3 Multi-Depth Deflectometer (MDD)

The MDD is a device that can measure both elastic deformation and permanent deformation in the pavement. It consists of several Linear Variable Differential Transducers (LVDT) installed at various depths of pavement.

Generally, the MDD system can be summarized in two aspects:

1. the LVDT module has a special housing that can be tightly attached and integrated with the pavement as a whole, i.e., any movement of pavement is exactly what the LVDT module senses; and
2. an anchor system is installed at a minimum depth of 3 meters and forms a rigidly fixed reference system, which serves as a reference point for the movement of the LVDT modules. In other words, the movement of pavement (or the reading of LVDT modules) is measured relative to the anchor.

Figures 2.8 and 2.9 show photos of the LVDT module and the anchor respectively. More detailed information on the MDD can be found in “Guideline to the Use and Operation of the Heavy Vehicle Simulator (HVS)” (CSIR 1995). The installation depths of Section 503RF are shown in Figure 2.6. The MDD data from MDD 4 (Figure 2.7) was utilized to back-calculate the stiffness.

2.3 Laboratory Test Data

The currently existing database of laboratory flexural fatigue beam testing of WesTrack consists of 151 fatigue tests at 20°C and a total of 35 test results from temperature susceptibility fatigue tests at various temperatures (5°C, 20°C, and 30°C). Tables A.4.1 and A.4.2 list the pertinent details of mix information and the test results. All these test beams were sawed from

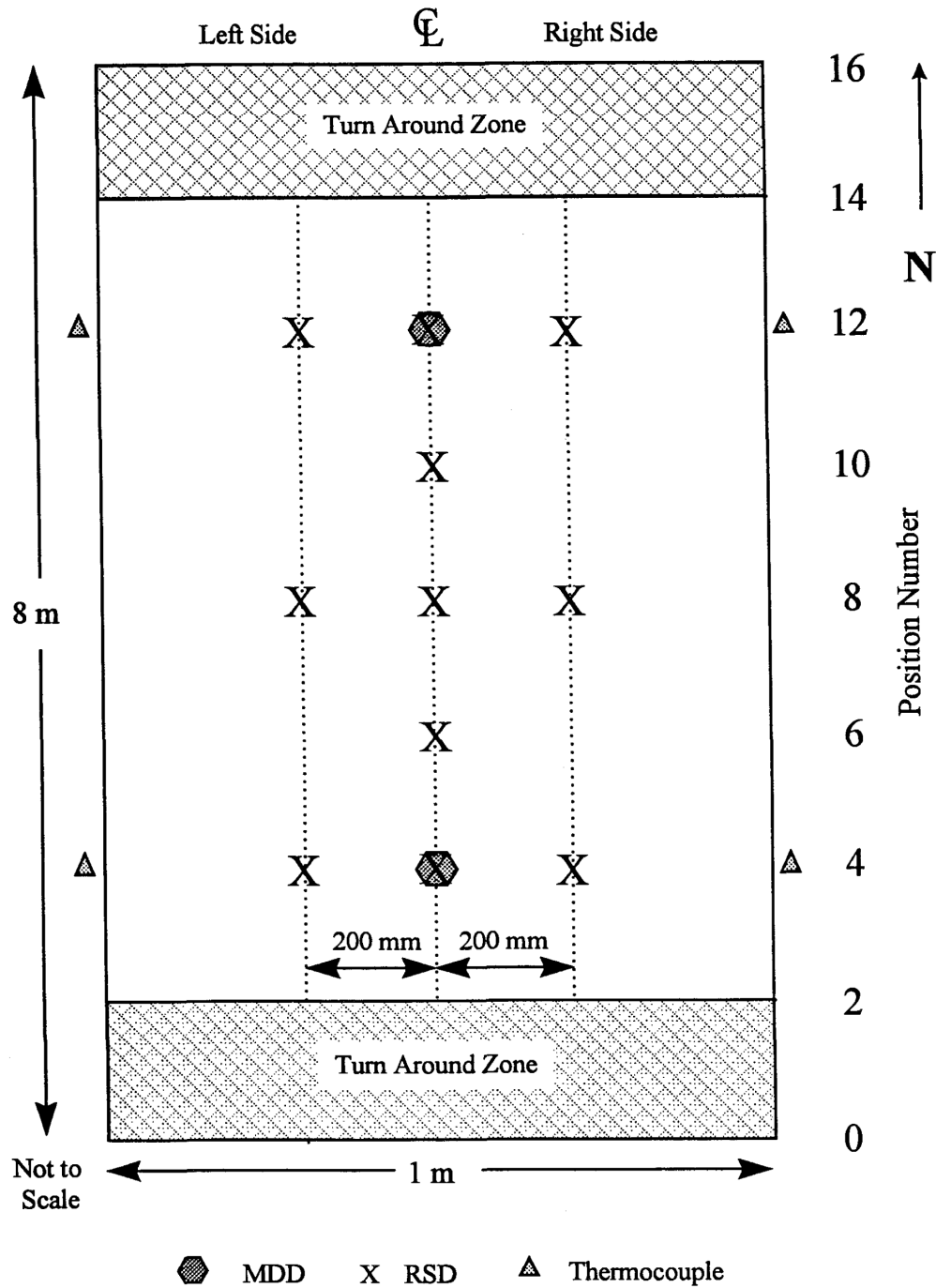

Figure 2.7. Plan view of test section and location of instruments for data collection (after Harvey 1997).



Figure 2.8. LVDT module of MDD (after CSIR).



Figure 2.9. Anchor assembly of the MDD installation set in concrete at depth of about 3 meters (after CSIR).

the field-mixed and field-compacted slabs from various original test sections (sections 1 through 26) of WesTrack prior to trafficking.

As for the CAL/APT HVS project, in addition to the field collected MDD data, a small set of laboratory fatigue tests with the same mixes (field-mixed and field-compacted) have been utilized to verify the feasibility of the Weibull accelerated failure time model.

3.0 TEST PLAN, SPECIMEN PREPARATION, AND TEST SETUP

3.1 Test Purpose

The questions raised in Chapter 1: “Is high temperature fatigue an important problem?” and, “How does temperature affect the fatigue damage process?” motivated this study of how to use laboratory fatigue test results to predict the in-situ fatigue performance. To accomplish this, a test plan with various experiments was necessary. The objectives of the test plan for this report are to:

1. Investigate the effects on fatigue damage and cracking of temperature, including temperatures greater than 30°C as well as the effects of tensile strain levels, and the effects of traffic repetitions.
2. Validate the stiffness deterioration hypothesis postulated in the Weibull dynamic approach and the corresponding relationship of stiffness deterioration with loading frequency, strain level, and temperature, and,
3. Assess the feasibility of applying the Weibull dynamic approach to long term fatigue performance prediction.

To achieve the test plan objectives, a modified flexural fatigue test setup was proposed to overcome the problems encountered at high temperatures with a conventional flexural fatigue test setup. In the following paragraphs, the modified flexural fatigue test setup and its related instrumentation and data acquisition system are discussed. Before discussing any specific test types, the specimen preparation procedure as well as the gradations used in the test plan are presented.

3.2 Test Setup

It has long been recognized that test temperatures greater than 30°C are a restricted zone for a conventional flexural controlled-strain fatigue test. The viscoelastic properties of asphalt concrete at high temperatures produce practical difficulties to installing the test specimen and running the test with a four-point flexural controlled-strain fatigue beam setup. As a result of these practical difficulties, no reliable laboratory fatigue data were collected at high temperatures by the WesTrack project. Consequently, an inaccurate prediction of fatigue performance is unavoidable when the extrapolation of the fatigue performance without the information in this restricted zone is applied. In light of this, before any further exploration of high temperature fatigue behavior or discussion of the Weibull dynamic approach, overcoming the limitations of the test setup at high temperature becomes the first priority. The difference between the conventional and modified flexural fatigue setups is briefly discussed here. The instrumentation and data acquisition systems of both setups are also explained.

3.2.1 Conventional Flexural Controlled-Strain Fatigue Test Setup

The conventional flexural controlled-strain fatigue test is a four-point bending test and is usually conducted at a temperature ranging from 0°C to 30°C. It is believed that within this range, the asphalt concrete beam behaves like a viscoelastic material but with sufficient stiffness to support beam for test duration within a limited strain range of interest and linear relation of deformation and load. Therefore, the desired test strain level can be achieved by controlling the maximum deformation based on the elastic beam theory. However, this calculated strain level is an assumed strain under the elastic beam theory. Strictly speaking, instead of calling it a “controlled-strain” fatigue test, it should more accurately be called a “controlled-deformation” fatigue test. One of the advantages of the four-point bending fatigue test is that the middle one-

third part of the beam is theoretically subjected to ‘pure’ bending without any shear deformation. The conventionally used accelerated fatigue test machine, shown in Figure 3.1, was developed by the SHRP A-003 project.



Figure 3.1. Conventional fatigue testing machine.

3.2.2 Modified Flexural Controlled-Strain Fatigue Test Setup

In this report, the terms “modified fatigue test setup” and “conventional fatigue test setup” are used to differentiate the two setups. The modified flexural controlled-strain fatigue test setup deviates from the conventional setup in three aspects. First, an aluminum (type 6061-

T6) support is placed below the specimen to prevent the creep effect from occurring due to specimen self-weight while subjected to high temperatures. A thin TEFLON™ sheet between the two provides a virtually frictionless interface. The aluminum support should be stiff enough to withstand the weight of a test beam.

Second, instead of being sinusoidally bent downward, the modified setup bends the beam upward; otherwise the test could not induce any tension and therefore no cracking. Third, another deviation from the conventional test setup is that, instead of utilizing LVDTs to control the tensile strain level, the modified flexural fatigue beam test is controlled by a strain gage that is attached on the extreme tensile surface of the asphalt concrete.

Figure 3.2 is a schematic plot showing the differences between the modified and conventional flexural fatigue setups. As can be visualized in Figure 3.2a, the conventional test setup bends the asphalt concrete beam downward to a position that generates the designed tensile strain at the bottom surface of the beam and then returns it to its original position following a sinusoidal-wave deformation control shifted so that a peak of the sinusoidal-wave is the original unloaded position. In Figure 3.2b, the modified test setup bends the beam upward to a position that generates a desired tensile strain at the top surface of the beam and then returns it to its original position following a sinusoidal-wave strain control, directly controlled by the strain gage.

The reason for developing the modified flexural controlled-strain fatigue test is mainly to conduct high temperature fatigue tests at 40°C. Having devised a setup, a temporary temperature control unit was subsequently built. The test machine along with the temperature control unit is shown in Figure 3.3. Inside the temperature control box, a heating element was placed at the

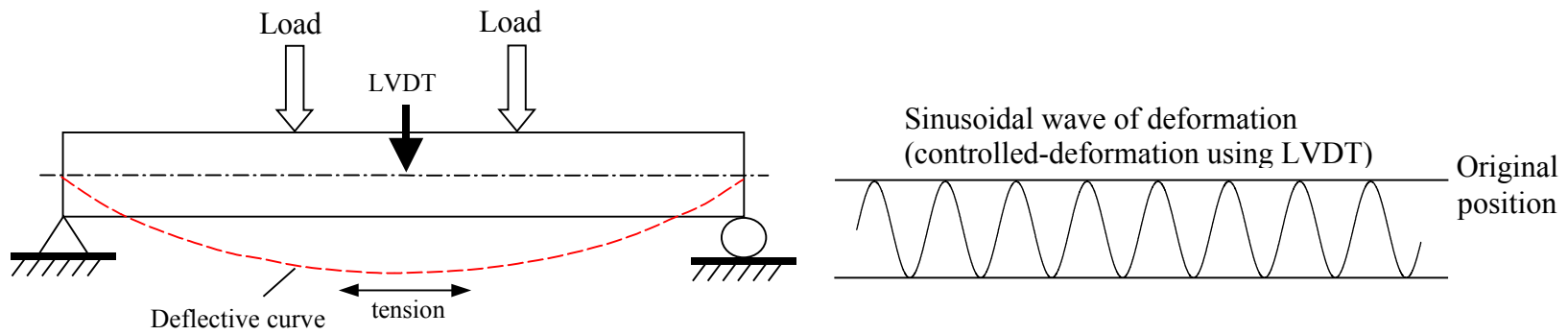

(a) Conventional flexural fatigue test setup

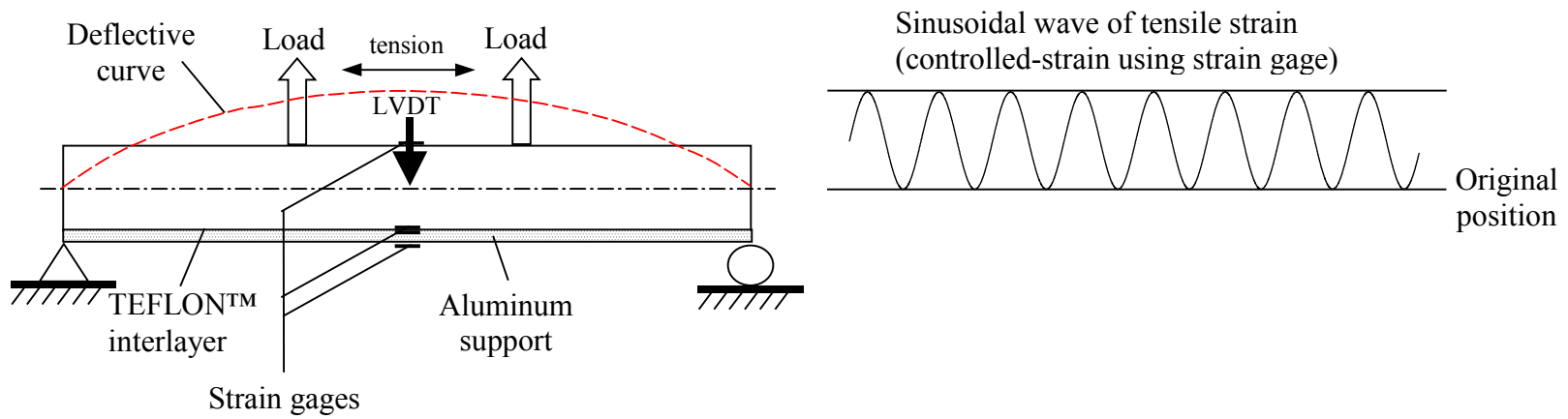

(b) Modified flexural fatigue test setup

Figure 3.2. Schematic plots of conventional and modified flexural fatigue test setups.

back of the fatigue module to generate enough heat to maintain the desired temperature. Three fans were installed in the box to ensure good air circulation and a uniform temperature; as shown in Figure 3.4, two fans hang at the back and one is seated in the front. Note that in Figure 3.4, the aluminum support can be seen just underneath the beam. A side view of the setup, without the side panels of the temperature box in place, is shown in Figure 3.5. A closer side view of the LVDT and the aluminum support is shown in Figure 3.6.

3.2.3 Instrumentation and Data Acquisition System

One deviation separating the conventional setup from the modified setup is that the modified setup utilizes a strain gage to control the tensile strain rather than using LVDT control. Figure 3.7 shows the strain gages attached to both the aluminum support and the asphalt concrete beam. Two long strain gages, EA-06-20CBW-120/option w from Measurements Group, Inc., with a gage length of 50.80 mm are separately attached to the top and bottom of the asphalt beam using the M-Bond AE-10 adhesive kit (also from Measurements Group, Inc.). The placement of these long strain gages is dependent upon the roughness of the asphalt concrete surface and also the extent to which their wires will interfere with the test setup. Ideally, if possible, the strain gages should be affixed to the top and bottom surfaces and aligned centrally in both the lengthwise and widthwise directions. However, this is not the case usually encountered, for oftentimes roughness or cavities are present on the surface of the beam. Therefore, most of the time the center position along the lengthwise direction can be maintained but the position along the widthwise direction must be adjusted to avoid the cavities or the interference of wires. It is usual to have to affix the bottom strain gage close to the edge to avoid the wires interfering with the test frame. To ensure the quality and durability of gluing, an appropriate clamping pressure



Figure 3.3. Modified fatigue test setup with temperature control box.

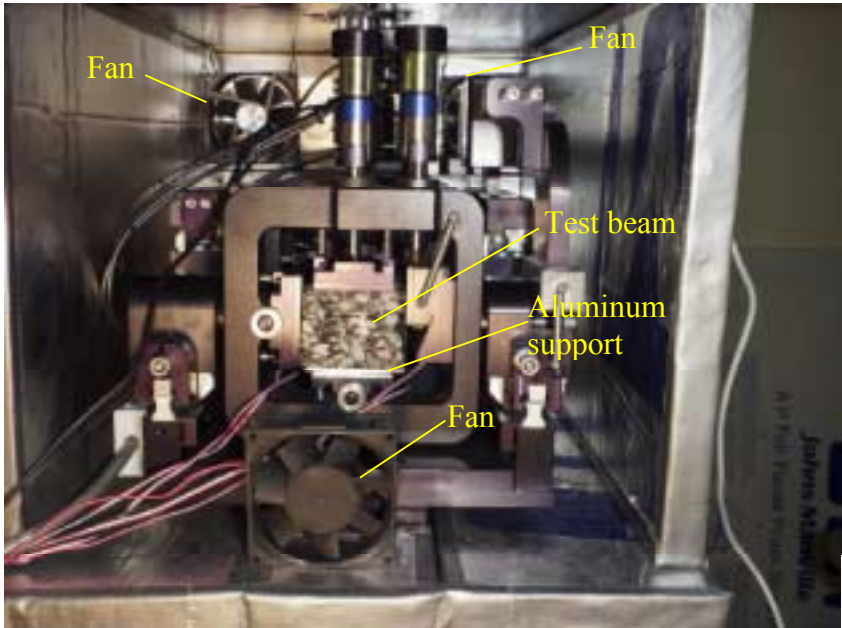

Figure 3.4. Modified fatigue test setup: inside view.

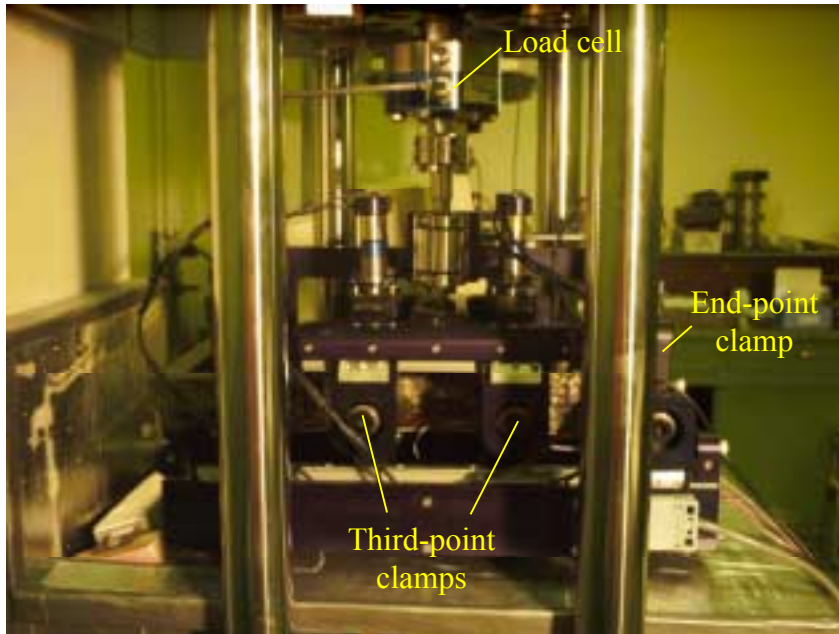

Figure 3.5. Modified fatigue test setup: side view (1).

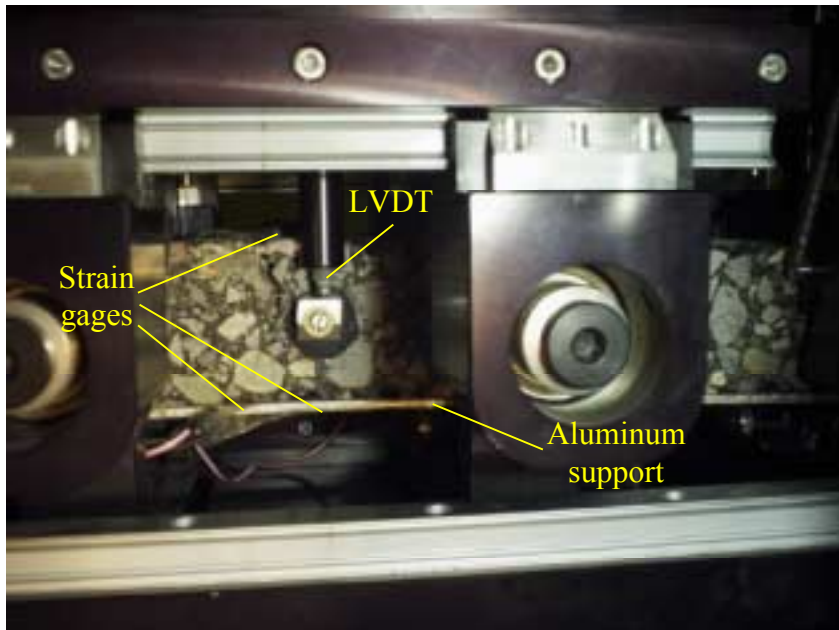

Figure 3.6. Modified fatigue test setup: side view (2).



Figure 3.7. Strain gages attached on beam and aluminum support.

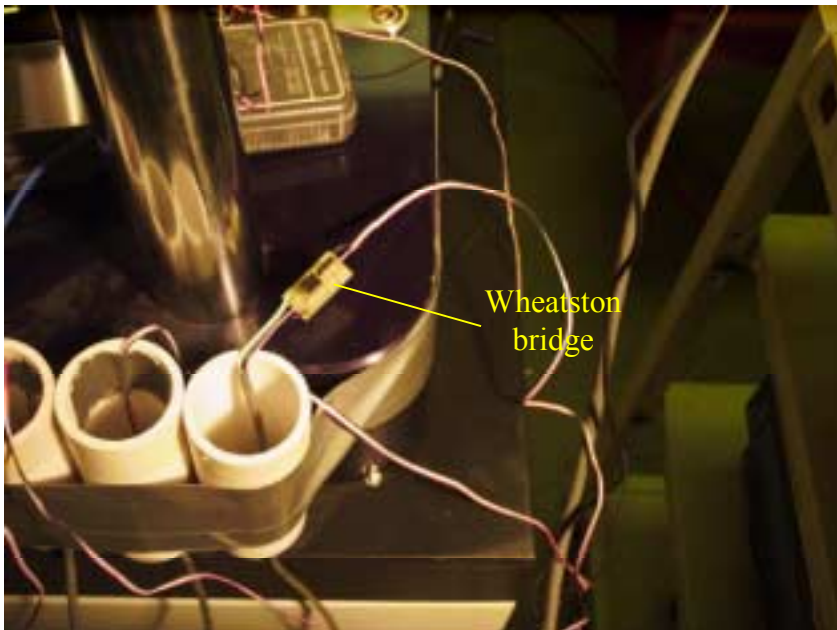
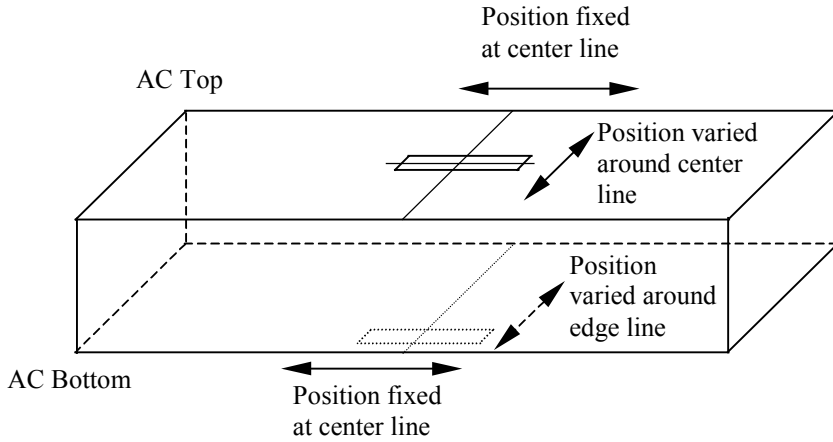
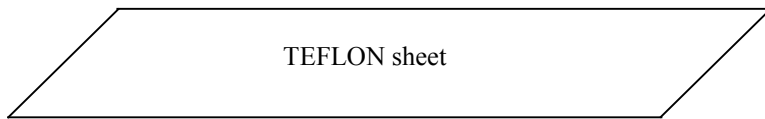

Figure 3.8. Wheatstone bridge.



Asphalt concrete beam: 381.0 mm. (L) x 50.8 mm. (H) x 63.5 mm. (D)



TEFLON™ sheet: 381.0 mm. (L) x 2.39 mm. (H) x 63.5 mm. (D)

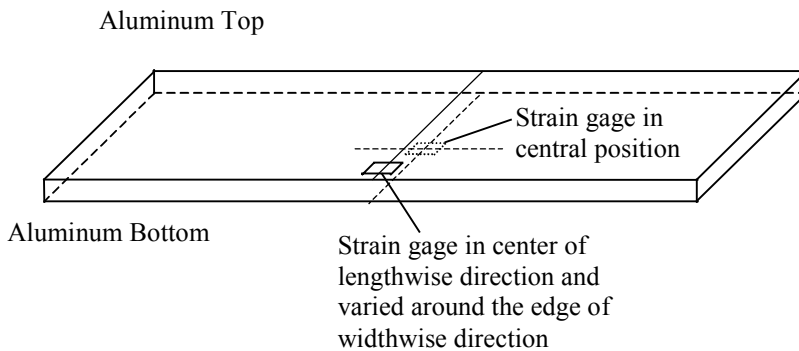

6061-T6 Aluminum support: 381.0 mm. (L) x 3.18 mm. (H) x 63.5 mm. (D)

Figure 3.9. Strain gage locations and dimensions of asphalt concrete beam, TEFLON™ sheet, and aluminum support.

must be applied during the curing stage of gluing. The strain gages on the asphalt concrete are approximately two times longer than the maximum aggregate size in the mix.

Two short strain gages, EA-06-250BG-120/option p from Measurements Group, Inc., with a gage length of 6.35 mm are placed on surfaces of the aluminum plate with an instant glue, CN-E cyanoacrylate adhesive from Tokyo Sokki Kenkyujo Co., which is an instant-type glue that will bond in roughly 2 minutes with only finger-tight pressure on the glued elements needed. Since the surfaces of the aluminum support are very smooth, the bottom strain gage was glued in the central position at both directions; the top strain gage, next to the TEFLON™ sheet, was placed in the center of the lengthwise direction and close to the edge in a widthwise direction.

The strain gage on top of the asphalt concrete beam is utilized as the command channel in a closed-loop control system, namely the Automated Testing System (ATS) from the SHRP Equipment Co. The rest of strain gages are utilized as the monitoring channels so that it is possible to analyze the mechanics of this fatigue setup. In addition to the strain gages, a conventional LVDT is still used to monitor the deflection of the beam, and the load cell reading is recorded as usual. The temperature is controlled but not recorded. A Wheatstone bridge, as seen in Figure 3.8, was connected between the signal conditioner and strain gage to amplify the signal. Figure 3.9 illustrates the locations of strain gages and gives detailed dimensions of the asphalt concrete beam, TEFLON™ sheet, and aluminum support.

3.3 Specimen Preparation

3.3.1 Gradation Curves of WesTrack

The individual gradation curves used for the original WesTrack mixes, namely coarse, fine, and fine-plus, have been described in Chapter 2. The same mixes were used in the

preparation of test beams so as to extend the existing database of WesTrack for use in this study. In addition to the original WesTrack mixes, several gradation curves were selected to estimate the gradation variability. Two additional gradation curves, designated as coarse high (CH) and coarse low (CL), based on the original WesTrack coarse gradation (coarse medium, CM), were created by shifting the CM gradation upward and downward as depicted in Figures 3.10 and 3.11. The other two gradation curves, designated as fine high (FH) and fine low (FL), based on the original WesTrack fine gradation (fine medium, FM), were generated by moving the FM gradation up and down as depicted in Figures 3.12 and 3.13. The corresponding percentage passing information is listed in Table 3.1.

3.3.2 Procedure of Specimen Preparation for WesTrack

In general, the specimen preparation for WesTrack consisted of sieving, wet sieving, batching, mixing, rolling, cutting and air-voiding. Each activity is described briefly below.

- **Sieving:** Five different bins were received: $\frac{3}{4}$ " , $\frac{1}{2}$ " , $\frac{3}{8}$ " , Wadsworth sand, and rockdust. Each was oven dried prior to sieving. Then, each bin was individually sieved and stored in buckets by sieve size. Later the sieved aggregate were combined to meet the batching criteria for various gradation requirements.

Wet sieving: The purpose of this activity is to verify whether the batched gradation matches the designed gradation. The test standards utilized are ASTM C117 (wet sieve analysis) and ASTM C136 (dry sieve analysis). In this study, six gradations were chosen for the laboratory-mixed and laboratory-compacted mixes. They are CH, CM, CL, FH, FM, and FL. The coarse gradations were composed of material

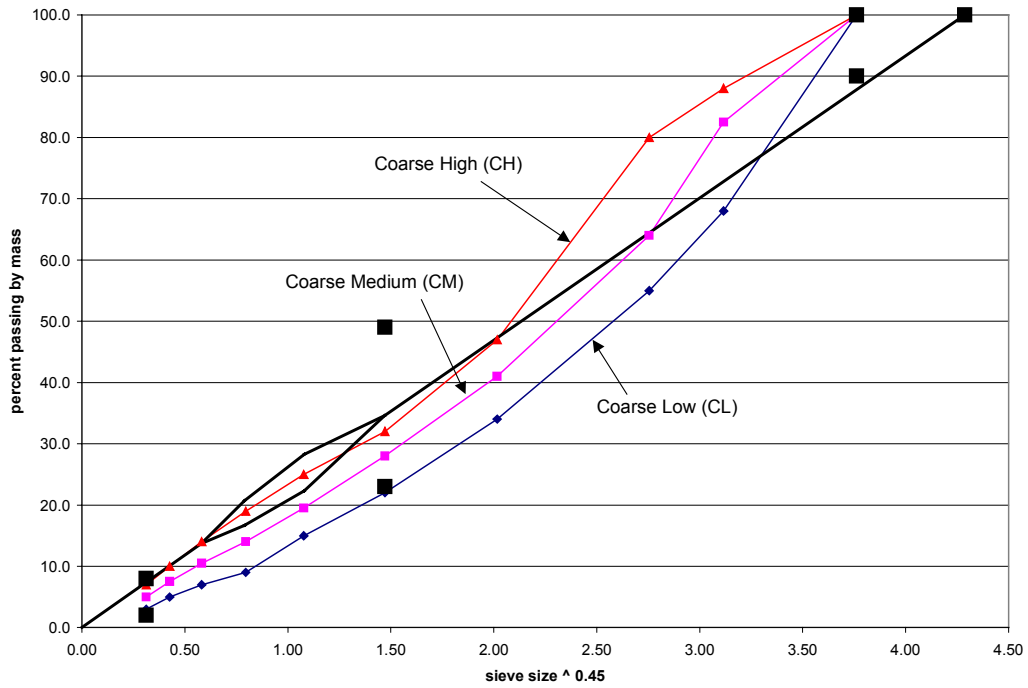

Figure 3.10. Individual WesTrack coarse gradation curves on a 19-mm nominal size 0.45 power chart.

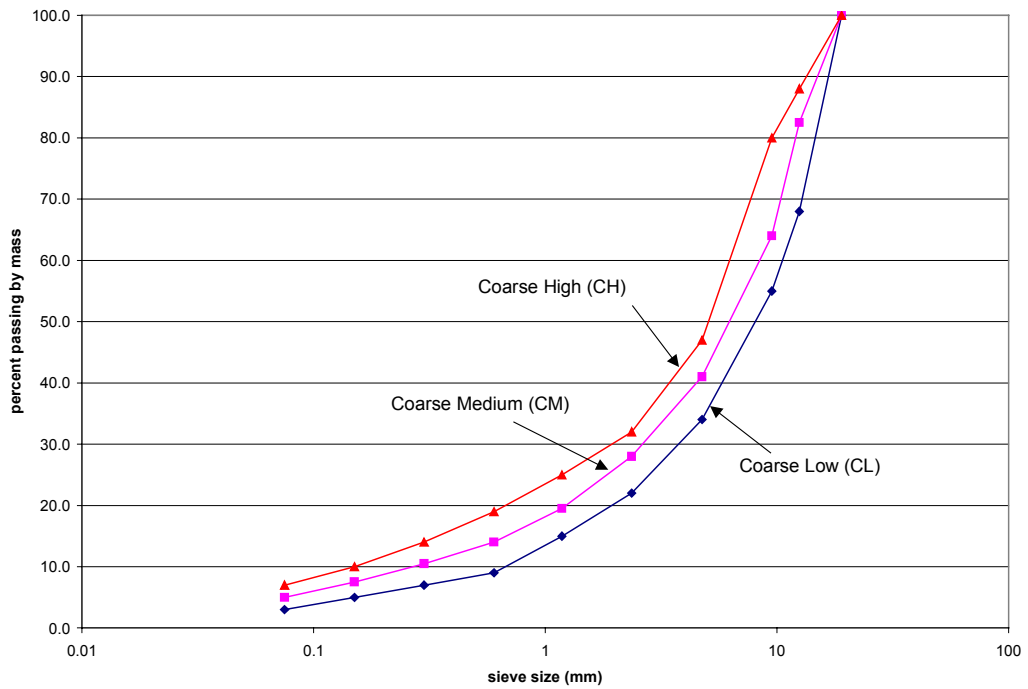

Figure 3.11. Individual WesTrack coarse gradation curves on a semi-logarithmic chart.

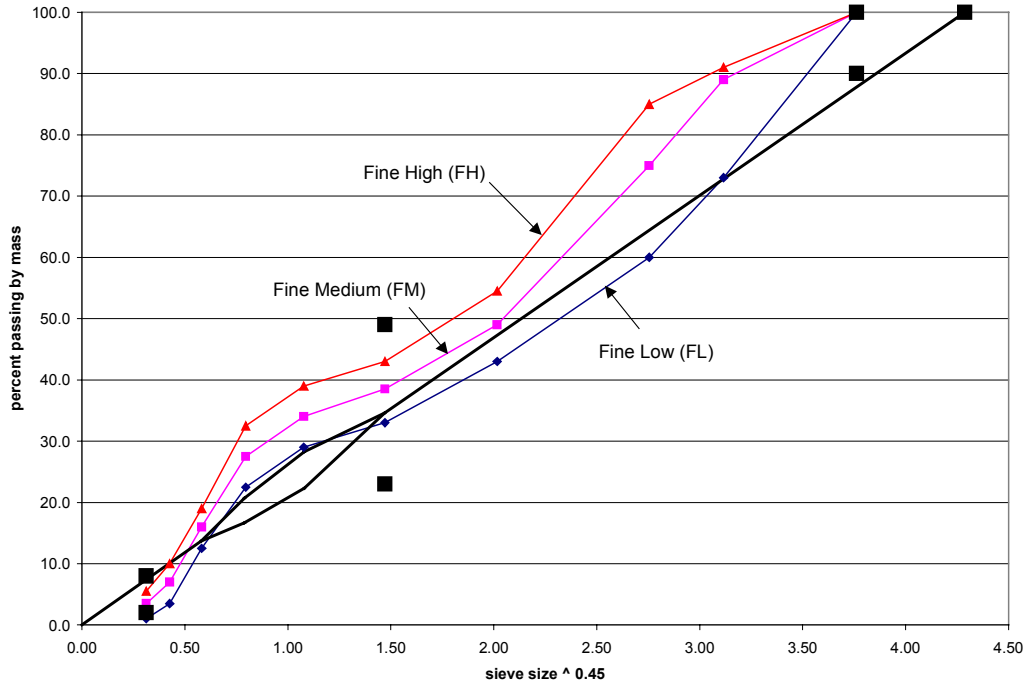

Figure 3.12. Individual WesTrack fine gradation curves on a 19-mm nominal size 0.45 power chart.

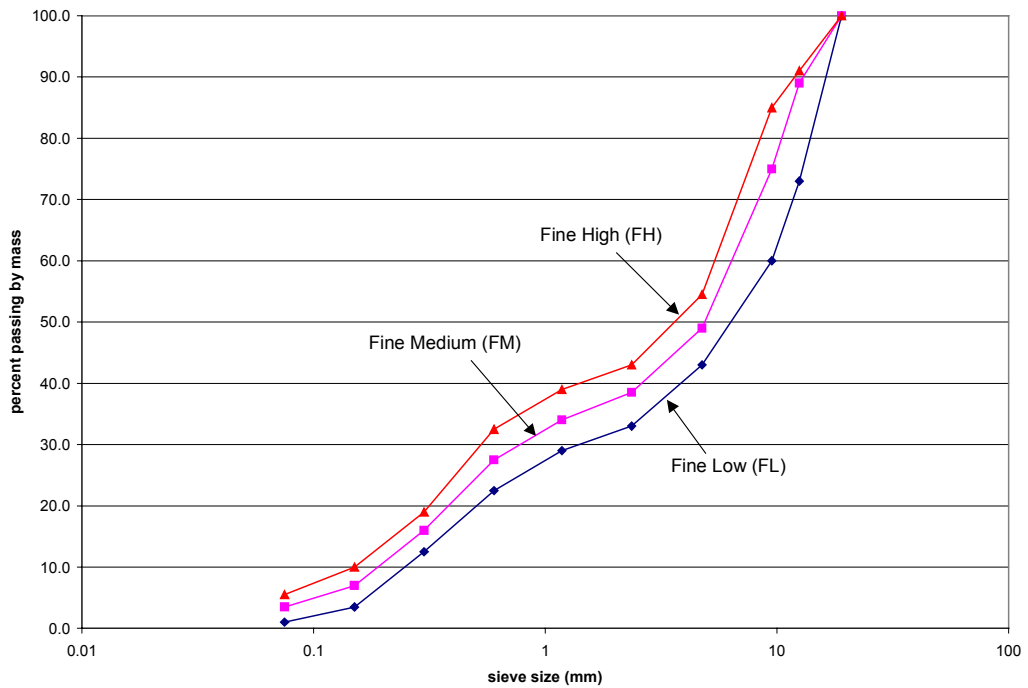

Figure 3.13. Individual WesTrack fine gradation curves on a semi-logarithmic chart.

Table 3.1 WesTrack Original Construction Gradations and Laboratory-mixed and Laboratory-compacted Gradations

Sieve Size		WesTrack Target Gradations			WesTrack Lab-mixed and Lab-compacted Gradations					
		Fine	Fine-plus	Coarse	Coarse			Fine		
(US)	(mm)				CL	CM	CH	FL	FM	FH
1"	25.4	100.0	100.0	100.0	100.0	100.0	100.0	100.0	100.0	100.0
3/4"	19.0	100.0	100.0	100.0	100.0	100.0	100.0	100.0	100.0	100.0
1/2"	12.5	88.5	88.8	82.4	68.0	82.5	88.0	73.0	89.0	91.0
3/8"	9.5	75.4	76.1	64.6	55.0	64.0	80.0	60.0	75.0	85.0
#4	4.75	48.9	50.4	41.2	34.0	41.0	47.0	43.0	49.0	54.5
#8	2.36	38.4	40.2	27.8	22.0	28.0	32.0	33.0	38.5	43.0
#16	1.18	33.9	35.8	19.7	15.0	19.5	25.0	29.0	34.0	39.0
#30	0.6	27.6	29.7	14.6	9.0	14.0	19.0	22.5	27.5	32.5
#50	0.3	15.7	18.2	10.8	7.0	10.5	14.0	12.5	16.0	19.0
#100	0.15	6.8	9.6	7.7	5.0	7.5	10.0	3.5	7.0	10.0
#200	0.075	3.5	6.4	5.1	3.0	5.0	7.0	1.0	3.5	5.5

from the $\frac{3}{4}$ " , $\frac{1}{2}$ " , and rock dust bins. The fine gradations consisted of material from all five bins.

- **Batching:** Once the composition percentage was set from the wet sieving results, a 7-kilogram batch was prepared for each of the six gradations.
- **Mixing:** Prior to mixing with binder, hydrated lime was added to the aggregate blends. The hydrated lime was used in the WesTrack project to prevent the stripping of mixes. Before placing 1.5 percent hydrated lime by weight of aggregate into the aggregate blend, the aggregate blend was thoroughly mixed with 2 to 5 percent water by weight of aggregate. After mixing of the hydrated lime, the mix was then placed in the oven overnight to remove the water introduced during the mixing phase.

In order to obtain a homogeneous mix of aggregate blend and asphalt binder, it is necessary to heat up both materials before mixing. The aggregate blend with the hydrated lime was heated at 144°C for four hours and the asphalt binder for at least two hours or until the asphalt binder became consistent and workable enough to stir. The suitable amount of asphalt binder was then poured into the heated aggregate and hydrated lime blend. The mixing time is 5 minutes or until the aggregate is completely covered with asphalt binder. It should be noted that the mixing bowl and blades should be pre-heated with infrared heat lamps to avoid sticking.

- **Rolling:** The purpose of rolling is to reach the desired air-void content by pouring a certain mass of loose mix into a certain volume ingot and then compacting it with passes of the rolling wheel until the desired volume for the specimen is obtained. Prior to compaction, the mix is placed in the oven at 135°C for four hours for the short-term oven aging process. After the four hour curing time, the temperature was

raised to its compaction temperature of 138°C for two to four hours. At the same time, the compaction molds are being heated with infrared heat lamps. Before being poured into the molds, the loose mix is weighed carefully to achieve the desired mass and therefore the desired air-void content.

Half of the loose mix is poured into the ingot and tamped with a rod; the other half is placed on top of the first half and tamped with a rod in the same way. The rolling wheel then starts to roll over the mix in such a way that the center of the wheel is directly over the mix. This is done ten times. The next ten compaction passes are conducted such that the left edge of the rolling wheel runs over the center of the mix. After those ten passes, another ten are applied to the center. The following ten passes are performed such that the right edge of the rolling wheel runs over the center of the mix. Then ten more passes are applied at the center. This sequence of passes is repeated until the surface of the mix is flush with the surface of the platform. After finishing compaction, the ingot is left in place overnight to allow it to cool.

- **Cutting:** A circular masonry bit saw is used to cut the ingot into fatigue beams. The dimensions of beam specimens are 50.8 mm (2 in.) in height, 63.5 mm (2.5 in.) in width, and 381 mm (15 in.) in length.
- **Air-voiding:** This is the final activity to take place before any testing starts. The procedure followed is that of “Procedure—Bulk Specific Gravity of Compacted Bituminous Mixtures Using Parafilm-Coated Specimens” from Chevron Research Company (Del Valle 1985). Prior to testing, all specimens are weighed in water and in air for the air-void measurement. Specimens are first soaked in 25°C water and then dried with compressed air to a saturated surface dry (SSD) state. The weight in

air is then recorded. Parafilm is used to wrap the specimen and its weight is taken in air. Then the weight of the specimen with parafilm is recorded in water and finally the parafilm is removed to record the weight of specimen in water.

3.4 Test Plan

Once the goal has been determined, the specimens can accordingly be prepared following the aforementioned preparation procedure. Generally, all beams tested here have the original WesTrack gradations, the same binder, PG64-22, and the same aggregate sources. Based on the objectives of the test plan mentioned above, a series of various types of flexural fatigue tests were subsequently designed and conducted as listed in Table 3.2.

3.4.1 High Temperature Modified Flexural Controlled-Strain Fatigue Test

This test was designed to be a full factorial experiment with four factors each at two levels. The four factors were air-void content, aggregate gradation, test temperature, and strain level. The two levels for air-void content are 6.6 ± 1 percent and 11.2 ± 1 percent, coarse medium and fines medium for gradation, 30°C and 40°C for test temperature, and 200 and 400 microstrain for test strain level. The total number of tests run was $16 (2^4)$ with no replicates. With this additional information at temperatures 30°C and 40°C , the test database was used to investigate the fatigue behavior of asphalt concrete at high temperatures and the use of the Weibull proportional hazards model. The test setup utilized herein is the modified fatigue test setup with a loading frequency of 10 Hz.

The theoretical derivation of the high temperature flexural controlled-strain fatigue test is based on the flexural beam analysis with aluminum support, which is included in Appendix C.

Table 3.2 Laboratory Test Plan and Test Purpose

No.	Test Type	Test purpose	Test setup	No. of Tests
1	High temperature modified flexural controlled-strain fatigue test	Verify the fatigue behavior of asphalt concrete at temperatures greater than 30°C	Modified fatigue test setup with strain gage	16
2	Temperature susceptibility fatigue test (laboratory-mixed and laboratory-compacted)	Extend the database of temperature susceptibility fatigue response of WesTrack	conventional	24
3	Fatigue test with various gradation types	Assess the difference of fatigue performance due to the change of gradation	conventional	24
4	Flexural frequency Sweep Test	Verify the correctness of the modified fatigue setup and explore the relationship among initial stiffness, temperature, and loading frequency	Modified for 40°C-30°C-20°C series Conventional for 30°C-20°C-5°C series	4
5	Varied-strain fatigue test	Validate the stiffness deterioration hypothesis caused by various strain levels.	conventional	6
6	Varied-temperature fatigue test	Validate the stiffness deterioration hypothesis caused by various temperatures.	conventional	6

The analysis described in Appendix C is used to calculate the tensile complex modulus of asphalt concrete and thus monitor its stiffness deterioration process at high temperatures.

This set of test data was conjugated with the available WesTrack temperature susceptibility data (Appendix A: Table A.4.1 to Table A.4.4) to derive an integrated regression equation to represent the fatigue damage process while subjected to various testing conditions.

3.4.2 Temperature Susceptibility Fatigue Test with Conventional Setup

The purpose of this test was to extend the database of temperature susceptibility fatigue behavior of WesTrack mixes with the laboratory-mixed and laboratory-compacted specimens. This test consisted of 24 beams with two gradation types (CM and FM), two asphalt contents (5.7 and 5.4 percent), three temperatures (5°C, 20°C, and 30°C), and two strain levels (200 and 400 microstrain). The test setup utilized was the conventional fatigue test setup with a loading frequency of 10 Hz.

3.4.3 Fatigue Test with Various Gradation Types

This is a test to verify the fatigue performance difference caused by various gradation types. A total of 16 specimens were tested. Four aforementioned gradation types designated as CL, CH, FL, and FH were used in the test. There were four beams of each gradation type of which two were tested at one strain level (300 microstrain) and two at another strain level (500 microstrain). Note that there was one replicate per gradation per strain. The gradation types CL and CH have a 5.7 percent asphalt content; FL and FH have a 5.4 percent asphalt content. All tests were conducted at a temperature of 20°C, with a 10 Hz loading frequency, and using the conventional fatigue setup. For purposes of statistical analysis, another 8 test results (four tests of CM and four tests of FM) at 20°C from the temperature susceptibility fatigue test for

laboratory-mixed and laboratory-compacted specimens are included, although the test strain levels are different.

3.4.4 Flexural Frequency Sweep Test

The objectives of conducting a flexural frequency sweep test are threefold:

1. to explore the relationship of loading frequency (or loading time) and the complex modulus of asphalt concrete while subjected to various temperatures,
2. to verify the feasibility of using strain gages in calculating the stiffness at high temperatures,
3. and to explore the possibility of integrating the results into the simulation program to characterize asphalt concrete stiffness under different vehicle speeds.

The loading frequencies utilized in this study are 15, 10, 5, 2, 1, 0.5, 0.2, 0.1, 0.05, 0.02, and 0.01 Hz. The 15 Hz upper limit is a constraint imposed by the capabilities of the test machine. The temperatures 40°C, 30°C, and 20°C were applied sequentially for the modified fatigue test setup, and 30°C, 20°C, and 5°C for the conventional fatigue test setup. The general principles for conducting frequency sweep tests are “Quick to Slow in loading frequency and Hot to Cold in temperature” to minimize damage to the specimen. The number of repetitions applied varies with loading frequency and ranges from 5 periods for 0.01 Hz to 300 periods for 15 Hz so as to obtain a stable measurement.

For the conventional fatigue test setup, the test is controlled by the LVDT to a deflection level that can generate 300 microstrain at the bottom surface of the asphalt concrete, whereas, for the modified fatigue test setup, the tensile strain is directly controlled by the strain gage at a 300 microstrain level. However, for the conventional fatigue test setup, the tensile strain occurring at the extreme fiber of the asphalt concrete will also be monitored by strain gages.

In addition to shedding light on the relationship among loading frequencies, complex moduli, and temperatures, another intent of conducting this test was to verify whether the test results obtained from the modified fatigue test setup match the results obtained from using the conventional fatigue test setup, especially at the common temperatures of 20°C and 30°C. Since thorough comprehension of complex moduli versus various temperatures and loading frequencies is not a major concern of this project, only a few beams were set aside for this type of test. To wit, four beams with the same asphalt content (5.7 percent), similar air-void content (around 9 percent), and with two gradations (WesTrack fine and coarse gradations) were used.

3.4.5 Varied-Strain Fatigue Test

The purpose of this experiment is to explore the behavior of fatigue damage under various patterns of strain levels and investigate the applicability of the wander effect of tires to fatigue life. These goals were to be achieved by using four varied-strain fatigue tests, consisting of a 200, 400, and 200 microstrain test; a 400, 200, and 400 microstrain test; a 400 and 200 microstrain test; and a 200 and 400 microstrain test. These tests will be referred to, respectively, as the 200-400-200 test, the 400-200-400 test, the 400-200 test, and the 200-400 test. The 200-400-200 and 400-200-400 tests had two replicates, whereas the 400-200 and 200-400 tests had only one replicate because of the limited number of test beams. All these tests were conducted at 20°C in a conventional fatigue setup with a 10 Hz loading frequency. The mix used here is coarse medium with an air-void content of 6.6 ± 1 percent and an asphalt content of 5.7 percent.

3.4.6 Varied-Temperature Fatigue Test

To explore the relationship between initial stiffness and the fatigue damage process is the major concern of this experiment's design. It is recognized that the stiffness of asphalt concrete

varies with the change of temperature. Thus, in this experiment design, two temperatures, 20°C and 30°C, were selected to represent the change of temperature. To simplify the number of factors, only one strain level (200 microstrain) was used. The varied-temperature fatigue tests consisted of,

1. a 30°C, 20°C, and 30°C test,
2. a 20°C, 30°C, and 20°C test,
3. a 30°C and 20°C test, and
4. a 20°C and 30°C test.

These tests will be hereafter referred to, respectively, as the 30-20-30 test, the 20-30-20 test, the 30-20 test, and the 20-30 test. The 30-20-30 tests had two replicates. The 30-20 and 20-30 tests had only one replicate. All these tests were conducted at a 400 microstrain level with a 10 Hz loading frequency. The mix used here was coarse medium with an air-void content of 6.6 ± 1 percent and an asphalt content of 5.7 percent.

4.0 FATIGUE TEST RESULTS AND ANALYSIS

4.1 Background

It has long been acknowledged that the fatigue behavior of asphalt-aggregate mixes can be characterized by Equation 1.2:

$$N = A(1/\epsilon_t)^B \quad (1.2)$$

Monismith et al. (1985) suggested a more applicable model to describe the fatigue behavior of asphalt-aggregate mixes in general (as shown in Equation 1.1)

$$N_f = A(1/\epsilon_t)^a (1/S_{mix})^b \quad (1.1)$$

In this formula, the relation of initial stiffness to the fatigue life has been taken into consideration. Strain-based models have been used to predict pavement fatigue life in most of the literature (Finn et al. 1977, SHELL 1978, Asphalt Institute 1981). Taking the logarithm of both sides of Equations 1.1 and 1.2 presents a linear relationship. Equation 1.2 is a linear line and Equation 1.1 a linear surface in three-dimensional space. According to the conventional definition of laboratory fatigue life—cumulative load repetitions until a 50 percent reduction of the initial stiffness (S_0), each equation yields only one data point per test strain level. It is obvious that these equations fail to describe the fatigue damage process other than its beginning (S_0) and end (N_f).

Other researchers (Chomton and Valayer 1972, van Dijk 1975, van Dijk, Visser 1977, Pronk and Hopman 1990, Tayebali et al. 1992) have utilized an energy approach and shown that the total (or cumulative) dissipated energy to failure is related to fatigue life as illustrated in Equation 1.4,

$$W_{FAT} = A(N_{FAT})^Z \quad (1.4)$$

In the SHRP project A-003, Tayebali et al. (1994) proposed two surrogate fatigue models, namely, strain-dependent and energy-dependent models:

$$\text{Strain-dependent: } N_f = A \cdot \exp(B \cdot VFB) \cdot (\epsilon_0)^C \cdot (S_0'')^D$$

and

$$\text{Energy-dependent: } N_f = A \cdot \exp(B \cdot VFB) \cdot (w_0)^C \quad (1.5)$$

Where

- N_f = fatigue life,
- ϵ_0 = initial strain,
- S_0'' = initial loss stiffness, psi,
- w_0 = initial dissipated energy per cycle, psi,
- VFB = percent voids filled with bitumen, and
- $A, B, C,$ and D are experimentally determined coefficients.

Generally, none of the above mentioned approaches recognizes how fatigue damage to the mix actually develops as loading proceeds while the mix is subjected to specific testing conditions. In this chapter, the Weibull function used widely in mechanical engineering, will be introduced as a tool to describe the fatigue damage. Subsequently, a Weibull Proportional Hazards model (Weibull PH model) used in survival analysis will assist in developing the fatigue model to include not only mix properties but also environmental and traffic variables. The details of the Weibull PH model will be discussed in Chapter 5.

4.1.1 Interpretation of Weibull Curves

The stiffness ratio (SR) at repetition n , which is defined as the ratio of stiffness at repetition n over the initial stiffness (taken at about 50 repetitions), will be utilized as an index in characterizing the phenomenon of fatigue damage process throughout this study. The use of SR has several advantages over other indices such as dissipated energy. Some of these advantages are: (1) stiffness is easy to measure both in the laboratory and in the field, and (2) stiffness is

often utilized as an input for linear layered-elastic programs for pavement analysis, thus making it useful for programming fatigue performance prediction; this will be discussed in detail subsequently.

To present the stiffness deterioration process, the Weibull Curve, a curve following the Weibull survivor function with the form: $y = \exp(-\lambda x^\gamma)$, will serve as a tool to identify the damage process in asphalt concrete. The parameter γ is known as the shape parameter, while the parameter λ is the scale parameter. The Weibull function can also be represented as

$$\ln(-\ln(y)) = \ln \lambda + \gamma \ln x \quad (4.1)$$

That is to say, by identifying y as the SR, where the term $\ln(-\ln(\textit{stiffness ratio}))$, or $\ln(-\ln(SR))$, represents the y-axis and $\ln(\textit{repetition})$ or $\ln(n)$ the x-axis, then the Weibull survivor function is a straight line. In other words, if the Weibull assumption imposed on the fatigue damage process is tenable, then a plot of $\ln(-\ln(\hat{SR}))$ against $\ln(n)$ would give an approximately straight line (the \hat{SR} being the observed stiffness ratio). Note that the x in Equation 4.1 can be mathematically replaced by $\ln x$ or \sqrt{x} . Hereafter, the stiffness deterioration curve in terms of $\ln(-\ln(\hat{SR}))$ versus $\ln(\ln(n))$ or $\ln(n)$ will be referred to as the “Weibull curve.”

The feasibility of using Weibull curves to define the fatigue damage process can be schematically demonstrated with data obtained from fatigue tests on WesTrack mixes. Figure 4.1 shows a typical example of the Weibull fitting to flexural fatigue test data. As seen in Figure 4.2, the plot of $\ln(-\ln(\hat{SR}))$ versus $\ln(\ln(n))$ better fits the fatigue damage process than the plot of $\ln(-\ln(\hat{SR}))$ versus $\ln(n)$.

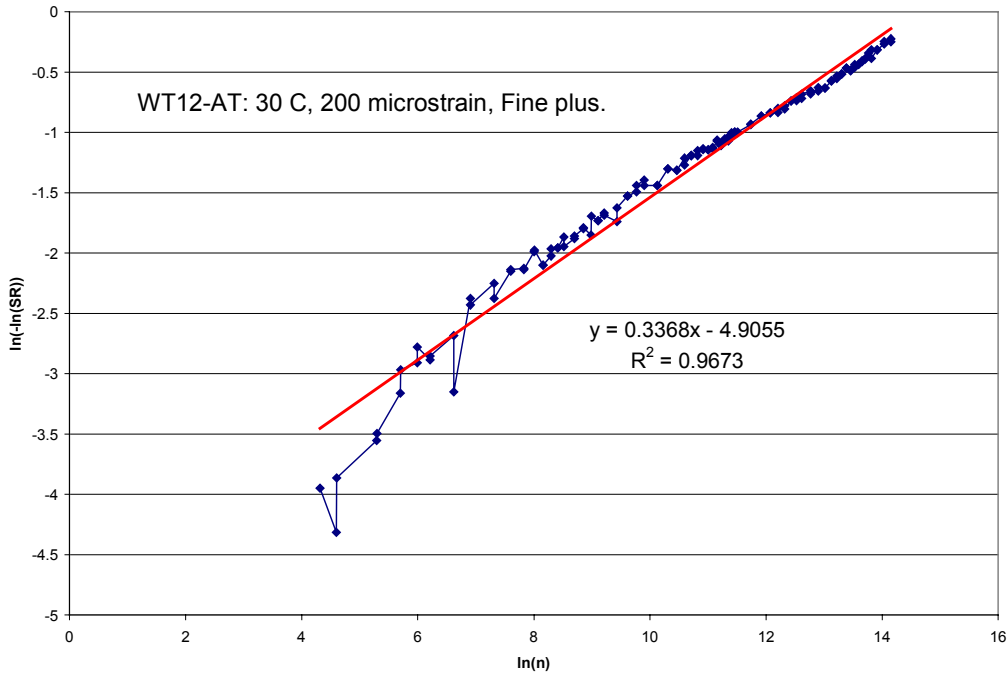

Figure 4.1. An example of fitting the Weibull survivor function to a fatigue test result in terms of $\ln(-\ln(SR))$ versus $\ln(n)$.

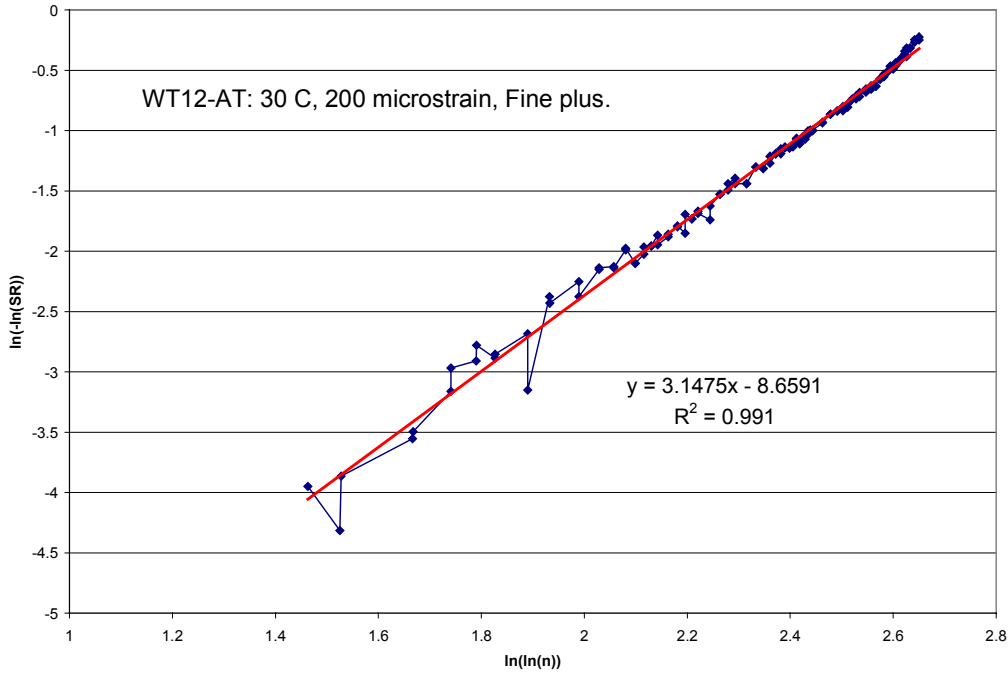

Figure 4.2. An example of fitting the Weibull survivor function to a fatigue test result in terms of $\ln(-\ln(SR))$ versus $\ln(\ln(n))$.

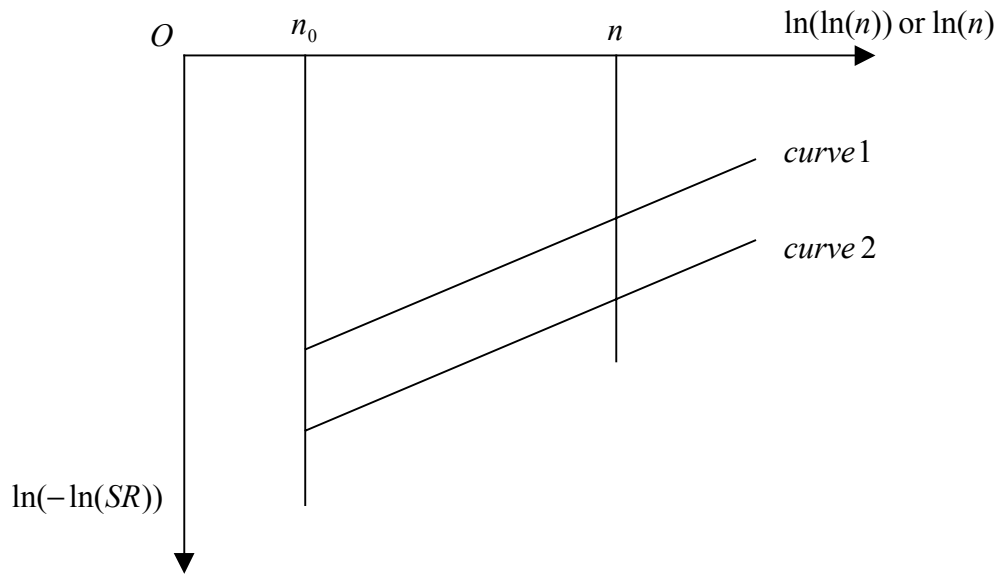

Figure 4.3. Two parallel Weibull curves.

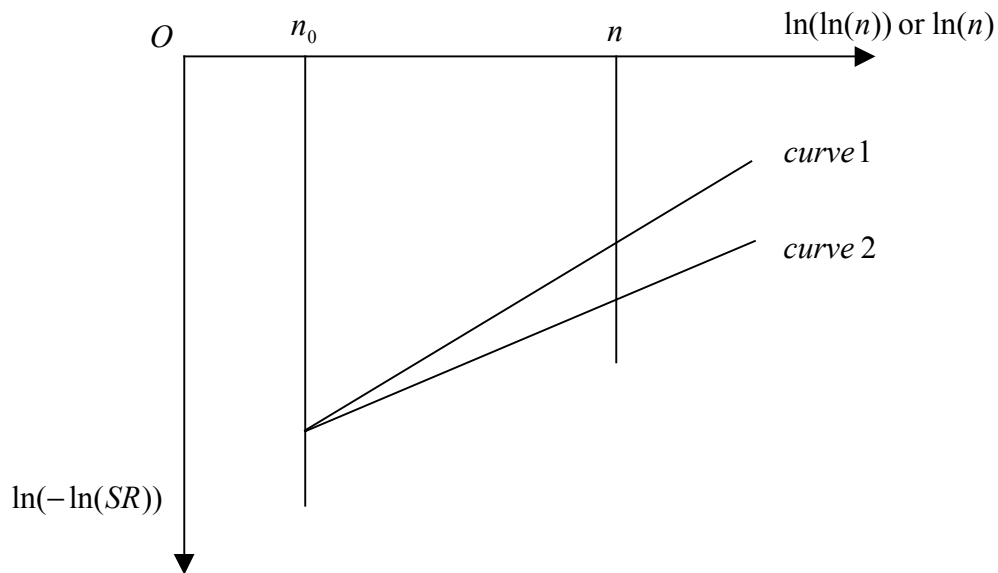

Figure 4.4. Two concurrent Weibull curves.

An explanation of the relationship between the fatigue damage process and the slopes and intercepts of Weibull curves is shown schematically in Figures 4.3 and 4.4. In the fourth quadrant of the Cartesian coordinate system of both figures the y-axis is labeled with $\ln(-\ln(SR))$ and x-axis marked as $\ln(\ln(n))$ or $\ln(n)$ respectively. The n_0 is the initial repetition that causes either the term $\ln(\ln(n))$ or the term $\ln(n)$ to vanish.

The following is an explanation of how to interpret the slope and intercept of Weibull curves. As shown in Figure 4.3, two Weibull curves have the same slope, i.e., the same fatigue damage rate, but have different intercepts. After n repetitions curve 1 shows more fatigue damage than does curve 2. In other words, curve 2 has a higher initial fatigue-resistant capacity than curve 1 from the point of view of material strength. In Figure 4.4, two Weibull curves have the same intercepts, i.e., the same initial fatigue-resistant capacity, but have various fatigue damage rates. In this case after n repetitions curve 1 has a more severe fatigue damage rate than does curve 2. Therefore, after n repetitions, material represented by curve 1 with a steep slope will accumulate more fatigue damage. Of great importance is what factors really affect the intercept and slope—initial fatigue-resistant capacity and fatigue damage rate—of Weibull curves. The following sections are devoted to exploring and identifying those significant factors that affect initial fatigue-resistant capacity and fatigue damage rate, particularly with regard to the various types of fatigue tests.

4.1.2 Crack Initiation and Weibull Curves

This study is mainly focused on the initiation of the bottom-up type of cracking, which was the type observed in the WesTrack pavement sections. Figure 4.5 illustrates a series of test results of fatigue tests that were conducted beyond 50 percent stiffness reduction. Two

observations can be made: (1) the curves have a reversed-S shape, and (2) at $SR = 0.5$, the conventional definition of fatigue failure, is the position where the curve starts to curl up. It is at this point, at the repetition where the curve starts to curl up, where it may be that the macrocrack initiates and starts to propagate.

To study the slope and intercept of the fatigue damage process in the Weibull curve, it is necessary to define the valid data range for the laboratory fatigue test to be utilized as input to the regression analysis. The stiffness deterioration curve should consist of three phases, as defined in Figure 4.6. The three phases are (1) Phase I: heating and arrived at temperature equilibrium, (2) Phase II: crack initiation developing, and (3) Phase III: crack propagating. The data points located in Phase II were used in this study as the valid data that provides the Weibull curve for crack initiation. It has been observed that sometimes no obvious difference exists between Phase I and Phase II. In such cases, the data associated with Phase I were also included.

In this chapter, a large number of fatigue analyses will be represented as $\ln(-\ln(SR))$ versus $\ln(n)$ or $\ln(\ln(n))$, where SR is the stiffness ratio, n the repetitions, and \ln the natural logarithm. In Chapter 5 both the theoretical derivation and application of these Weibull curves are provided. In this chapter, these plots are primarily used to explain the fatigue damage process and to identify significant factors that affect this process. Analyses of some test types in the following sections will be conducted with S-PLUS¹. Their corresponding S-PLUS codes, if any, will be listed in Appendix C.

¹ S-PLUS is a statistical software package that is from the StatSci division of MathSoft.

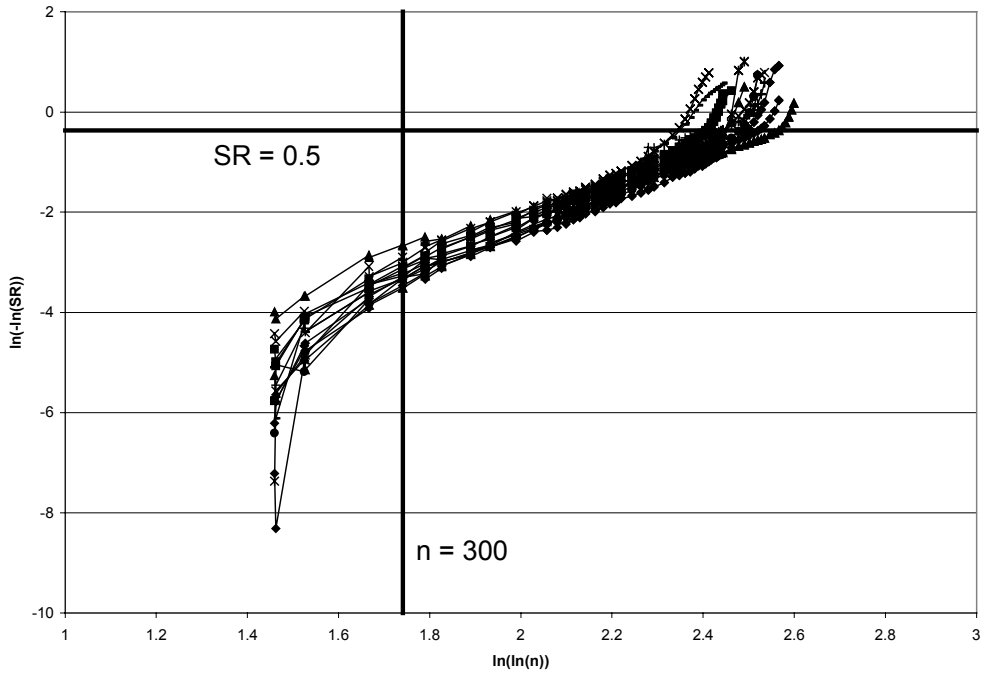

Figure 4.5. Weibull curves in reversed S shape.

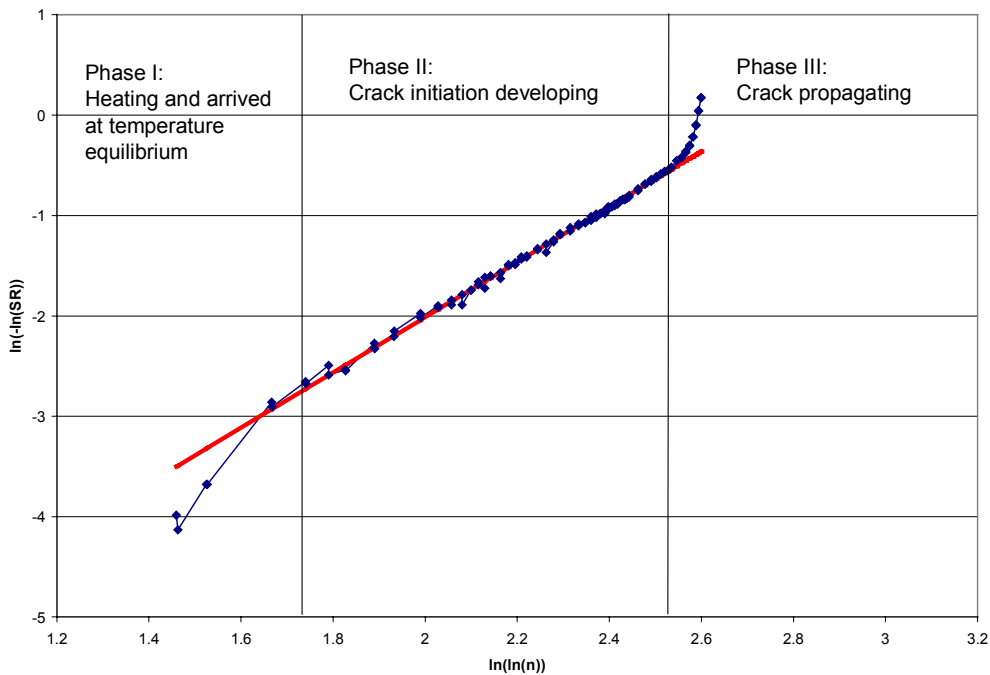

Figure 4.6. Weibull curve in three phases: (1) Phase I: Heating and arrived at temperature equilibrium, (2) Phase II: Crack initiation developing, and (3) Phase III: Crack propagating.

4.2 Fatigue Tests at 20°C

This data set consists of 151 fatigue beam tests using specimens cut from the 26 WesTrack test sections; 13 of them were from the top lift of the asphalt concrete layer, the other 138 beams were from the bottom lift. These tests were conducted by the author and other UCB staff as part of the WesTrack project, and are in addition to the tests described in the experiment plan developed for this report (Table 3.2). All of the beam specimens used were field-mixed and field-compacted. Table A.4.1 in Appendix A shows the details of mix information, test results, and regression analysis for each beam test. The independent variables investigated are listed in Table 4.1. The *av* used here is based on the UCB method of air-void measurement. The other independent variables here are adopted from Hand's dissertation (1998) of Table 123 for *ac*, Tables 136 through 141 for *m200*, *sa*, and *rs4s50*, and Tables 147 through 152 for the *vma* and *vfa*. Six dependent variables *lnnf*, *lnstif*, *aa*, *bb*, *cc*, and *dd* will be inspected herein. The variables *lnnf* and *lnstif*, as usual, represent the natural logarithms of fatigue life and stiffness respectively. The *aa* and *bb* are the regression coefficients obtained from the relationship $\ln(-\ln(SR)) = aa + bb \cdot \ln(n)$, where *SR* is the stiffness ratio and *n* is the repetitions; likewise, the *cc* and *dd* are the regression coefficients determined from the equation $\ln(-\ln(SR)) = cc + dd \cdot \ln(\ln(n))$. The ranges of the covariates and six response variables presented in this exploration are described in Appendix A, Table A.4.16.

These laboratory fatigue tests were conducted in the conventional flexural controlled-strain fatigue test setup with a loading frequency of 10 Hz, a test temperature of $20 \pm 1^\circ\text{C}$, and two test strain levels, 200 and 400 microstrain.

The reader should keep in mind that the identification of significant factors that affect fatigue behavior is the primary goal of this section as well as in the following sections for

Table 4.1 Covariates Investigated in Chapter 4

Covariate	Description	Units
<i>grad</i>	Gradation type	NA
<i>ac</i>	Percent asphalt content	%
<i>av</i>	Percent air-void content	%
<i>stn</i>	Test strain level	Microstrain
<i>rs4s50</i>	Ratio of the percent passing the 4.75 mm (#4) and 0.3 mm (#50) sieves	NA
<i>m200</i>	Percent passing the 0.075 mm (#200) sieve	%
<i>sa</i>	Blended aggregate surface area	m ² /kg
<i>vma</i>	Percent voids in mineral aggregate	%
<i>vfa</i>	Percent voids filled with asphalt	%
<i>temp</i>	Test temperature	°C

Note:

NA = not available

$$vma = \left[\frac{V_T - V_{agg}}{V_T} \right] \times 100\%, \text{ where } V_T = \text{total volume of mix, } V_{agg} = \text{volume of aggregate.}$$

$$vfa = \left[\frac{V_{asp}}{V_T - V_{agg}} \right] \times 100\%, \text{ where } V_{asp} = \text{volume of asphalt.}$$

different types of fatigue tests. To delineate the important factors, a sequence of observations and statistical analyses were conducted as described in the following sections.

Pairs Diagram and Correlation Matrix

Figures 4.7 and 4.8 are pairs diagrams that quickly explore the relationships among variables. The information presented in Figure 4.7 for fatigue life and stiffness clearly demonstrates that the *stn*, *av*, *ac*, and also *vfa* which is a function of *av* and *ac*, have obvious effects on fatigue life and that *av* has a significant effect on stiffness.

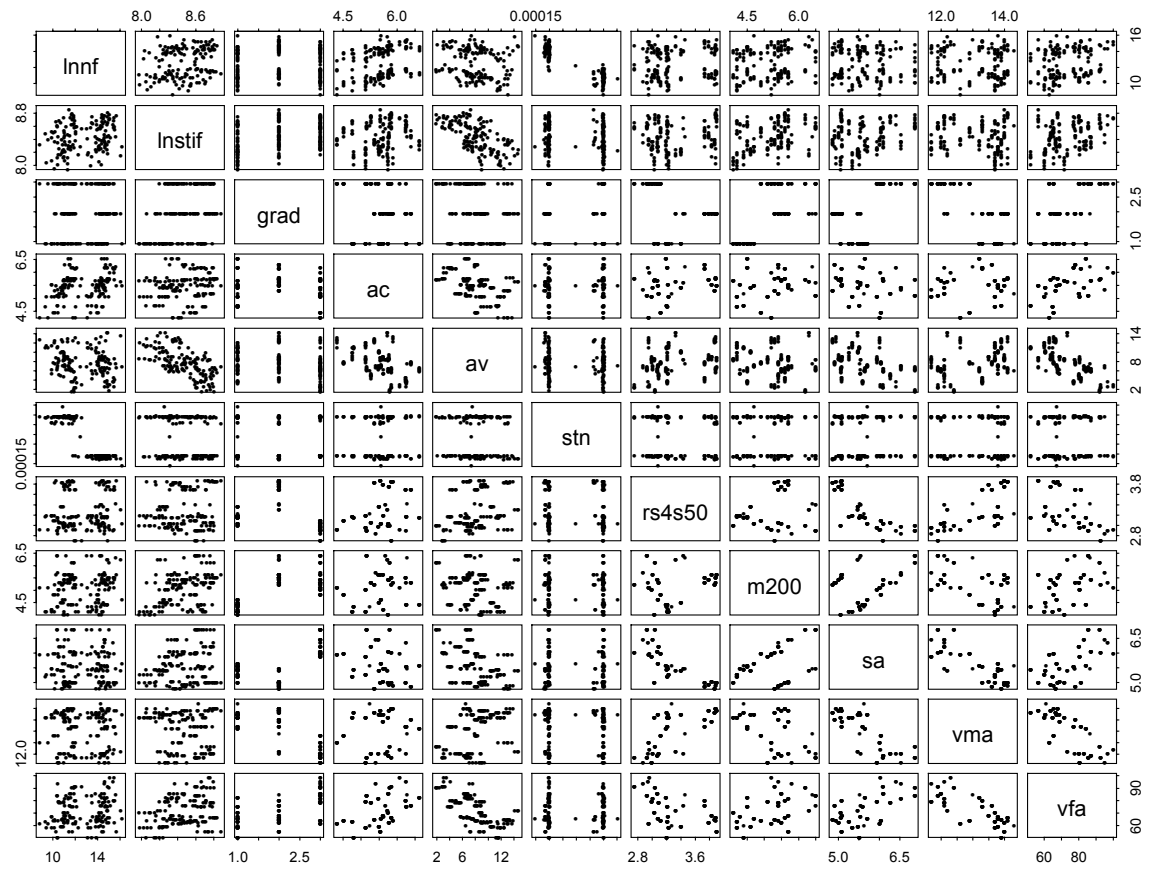

Figure 4.7. Pairs diagram for *Instif* and *lnnf* (fatigue tests at 20°C).

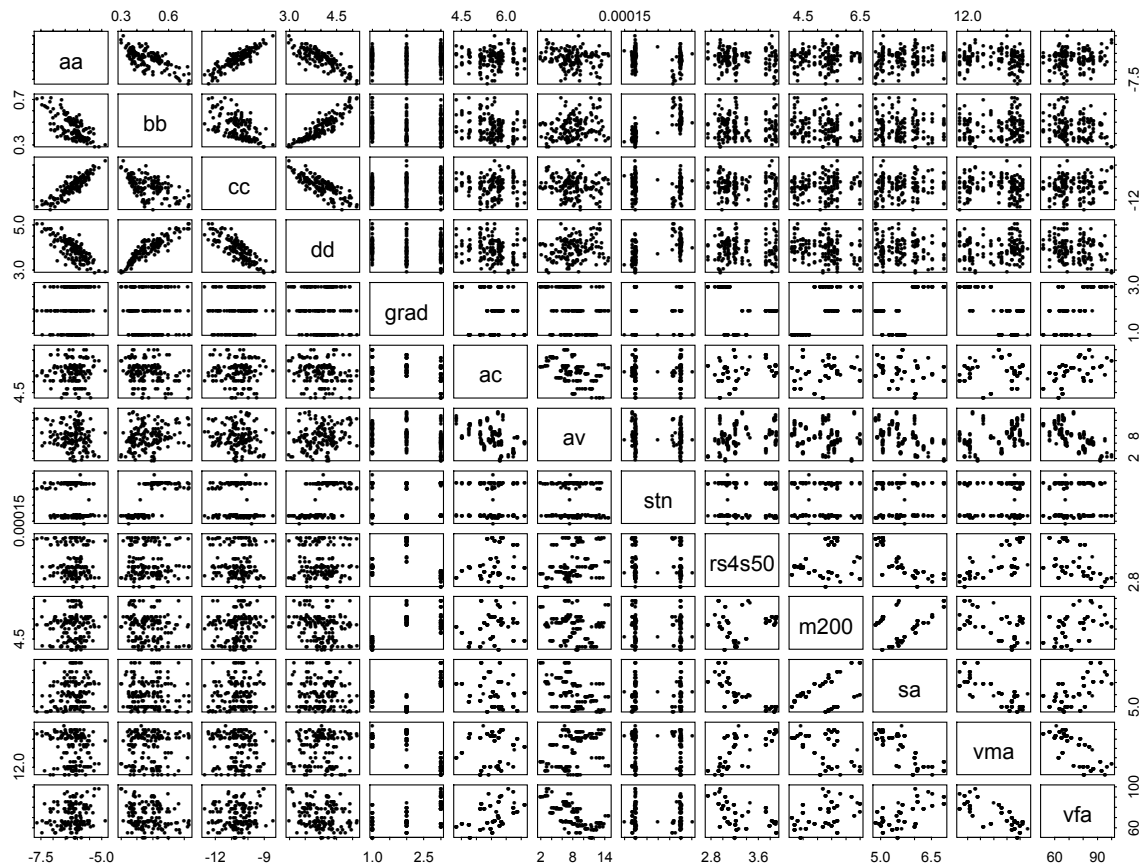

Figure 4.8. Pairs diagram for the regression coefficients *aa*, *bb*, *cc*, and *dd* of the Weibull curves (fatigue tests at 20°C).

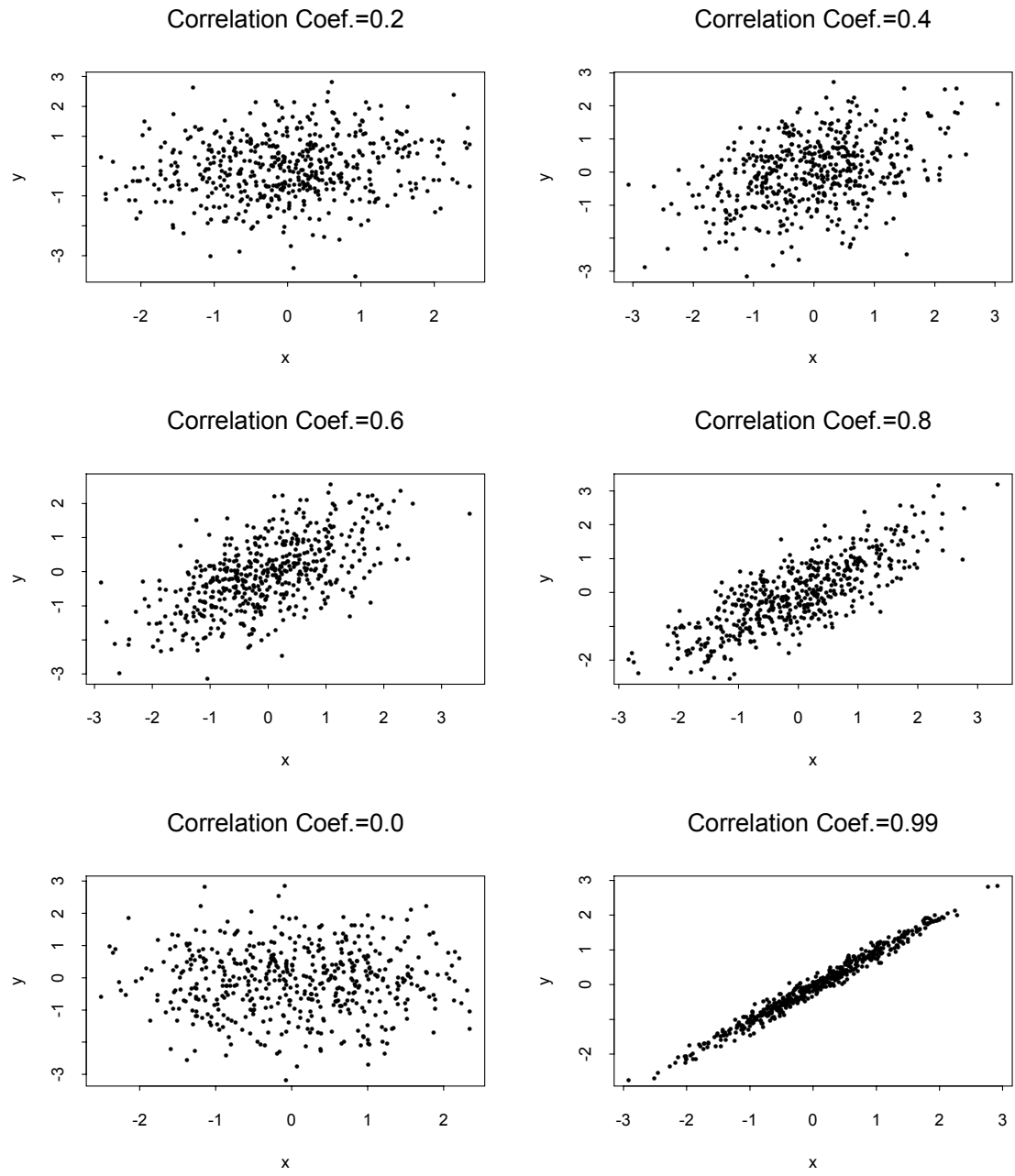

Figure 4.9. Scatterplots of 500 independent pairs of bivariate normal random variables with correlation coefficient $\rho = 0.2$, $\rho = 0.4$, $\rho = 0.6$, $\rho = 0.8$, $\rho = 0.0$, and $\rho = 0.99$.

The correlation matrix shown in Table A.4.6 measures the strength of linear relationships between the pairs of variables. Figure 4.9 presents a series of scatterplots of 500 independent pairs of bivariate normal random variables with several various correlation coefficients so as to give the reader an indication of how the scatterplots look if two normal random variables exist with a certain correlation coefficient. The corresponding algorithm regarding the generation of correlated random numbers is listed in Appendix C. Notice that the clouds of points are roughly elliptical in shape. From Figure 4.9, it seems that the marginally visually recognizable pattern could be set at a correlation coefficient value of 0.4; in other words, it is a subjective judgment.

Based on such subjective criterion, several findings from the scatter plots and correlation matrices can be addressed as follows:

1. The test strain level is highly negative when correlated with fatigue life; that is to say, a higher strain level will tremendously reduce the fatigue life.
2. The test strain level is highly positive when correlated with the coefficients bb and dd , which are the slopes in $\ln(-\ln(SR))$ versus $\ln(n)$ and $\ln(\ln(n))$ charts respectively; in other words, the fatigue damage rate is particularly affected by test strain level.
3. The air-void content counteracts the stiffness with a negative and high correlation coefficient, i.e., a higher air-void content will definitely bring down the value of stiffness.
4. No apparent correlations exist between the coefficients of aa and cc and the covariates.
5. As for the covariates $grad$, $rs4s50$, $m200$, sa , vma , and vfa , they are all mutually correlative. Note that these covariates are actually gradation-related. This reveals

that the multicollinearity problem will be a concern in future regression analyses conducted if these covariates are to be included simultaneously.

Design Plots, Factor Plots, and ANOVA results

According to the stem-and-leaf diagrams and histograms of each covariate, the covariate was categorized into three factor levels: low, medium, and high. Exceptions were the factor *stn*, which was separated into two factor levels of low and high, and the factor *grad*, which was classified by three factor levels, namely fine-plus, fine, and coarse. Thus, excepting *stn* and *grad*, two delineatory points were determined for each covariate. The *av* was marked “low” if less than 5 percent, “medium” if between 5 and 8 percent, and “high” if greater than 8 percent. For *av* then, the set of points was (5, 8). The same procedures were applied to the other covariates: *ac*, *rs4s50*, *m200*, *sa*, *vma*, and *vfa*, with corresponding sets of points (5, 6), (3, 3.5), (5, 6), (5, 6), (12.5, 13.5), and (65, 80).

A series of design plots based on the category criteria described above are presented in Figures 4.10 through 4.15. In these figures, the horizontal line represents the grand mean of the response variable, the vertical line marked with short ticks indicates the means of factor levels for a specific factor. Therefore, the farther apart the marked factor levels in the vertical line are, the more significant the effect of the factor on the response variable. Accordingly, several findings are remarked upon below:

1. In Figure 4.10, the *Instif* is primarily affected by the *av* and relatively insensitive to *stn*.
2. As seen in Figure 4.11, *stn* has a significantly greater effect on the fatigue life than it does on stiffness. The *av* and *ac* also affect the fatigue life; it should also be noted

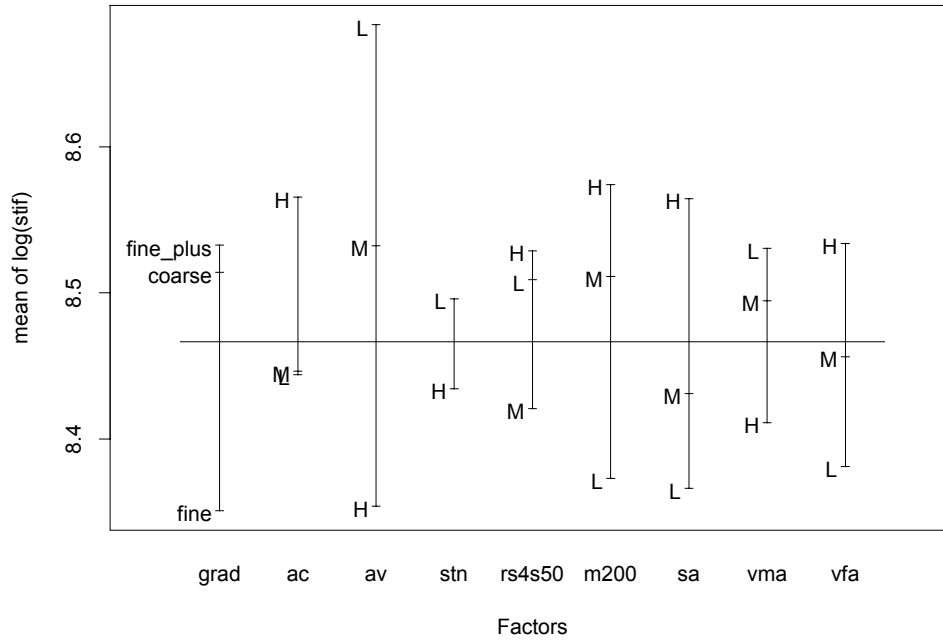

Figure 4.10. Design plot of *lnstif* (fatigue tests at 20°C).

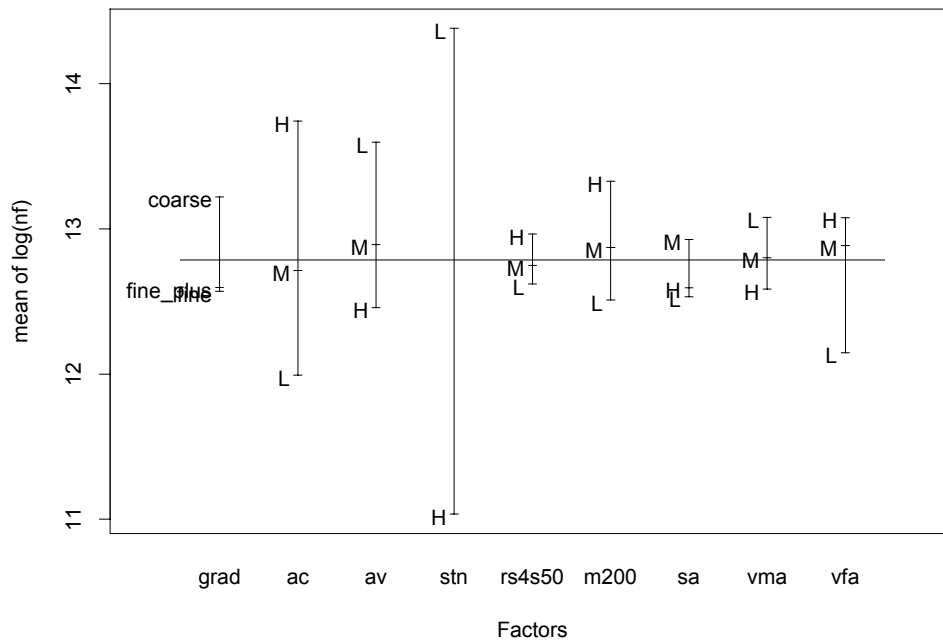

Figure 4.11. Design plot of *ln nf* (fatigue tests at 20°C).

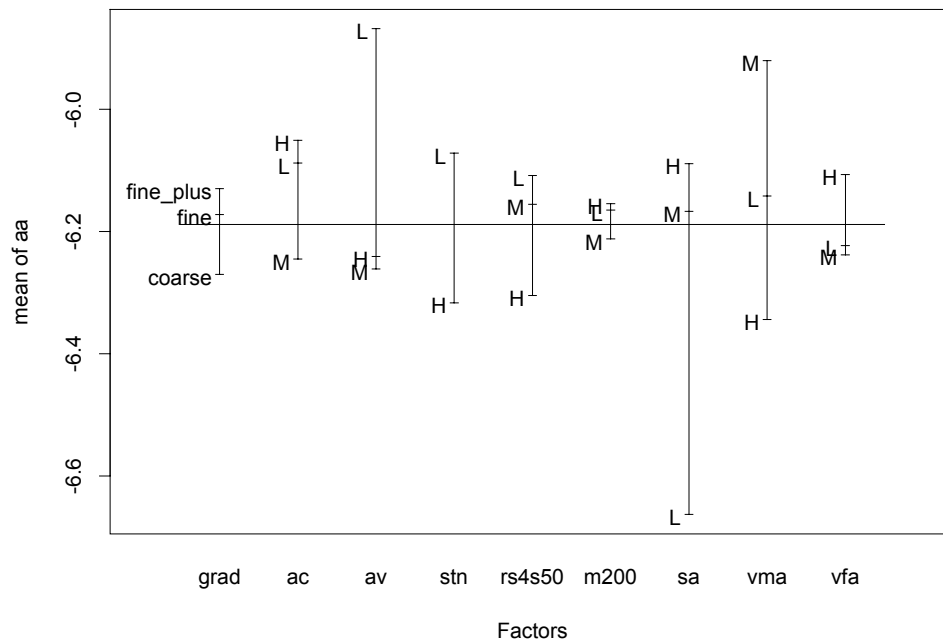

Figure 4.12. Design plot of *aa* (fatigue tests at 20°C).

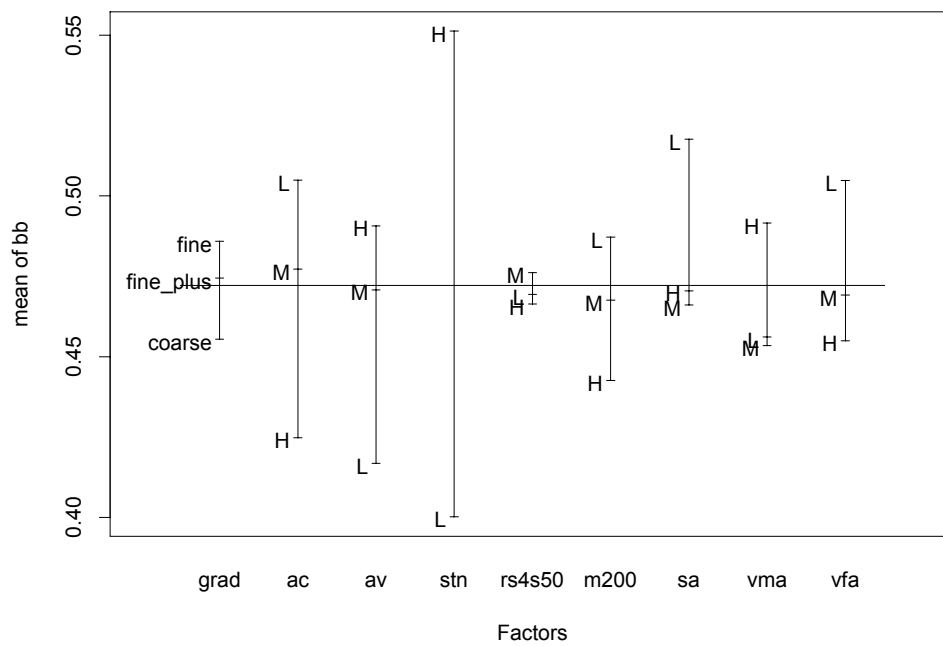

Figure 4.13. Design plot of *bb* (fatigue tests at 20°C).

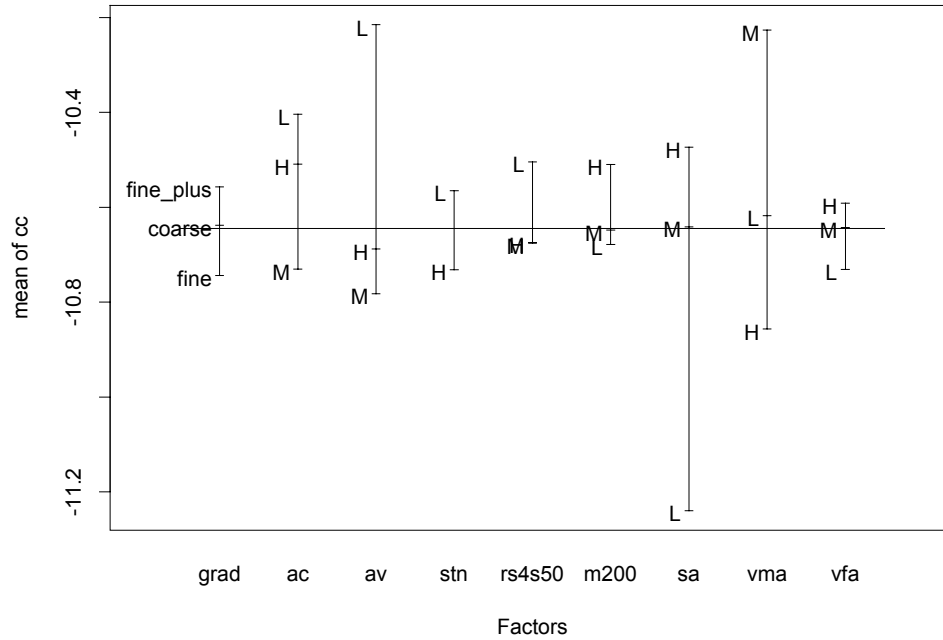

Figure 4.14. Design plot of *cc* (fatigue tests at 20°C).

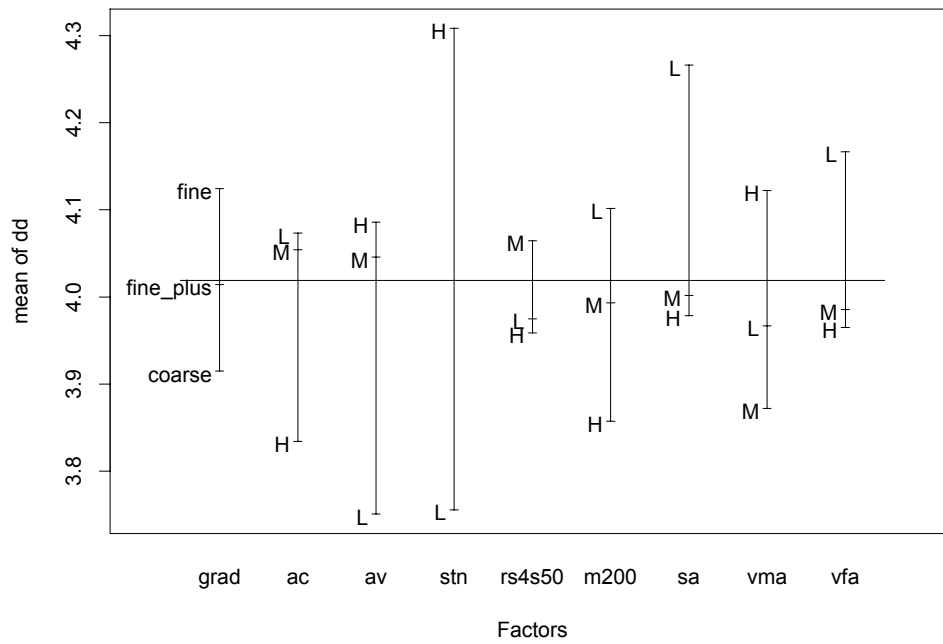

Figure 4.15. Design plot of *dd* (fatigue tests at 20°C).

- that the low *av* content and high *ac* content result in high fatigue life. The same conclusions can be found on the work done by Epps (1968) and Harvey (1992), although their results were for different gradations and controlled-stress testing. Interestingly, although in a marginal sense, the fatigue performance of the coarse gradation is higher than that of either the fine-plus or fine gradations. No evident difference of fatigue performance exists between the fine-plus and fine gradations.
3. The coefficient *aa*, which is the intercept of equation $\ln(-\ln(SR)) = aa + bb \cdot \ln(n)$, is mostly affected by *sa* and to a lesser degree by its relations to *av* and *vma*, as shown in Figure 4.12.
 4. The coefficient *bb*, which is the slope of equation $\ln(-\ln(SR)) = aa + bb \cdot \ln(n)$, is primarily affected by *stn* and to a lesser extent by *ac* and *av*, as shown in Figure 4.13. These findings are in keeping with current ideas regarding the fatigue of asphalt concrete, i.e., higher strain, higher air-void content, and a lower asphalt content will lead to increased fatigue damage.
 5. From Figures 4.14 and 4.15, similar conclusions as in (3) and (4) can be drawn for coefficients *cc* and *dd*, which are the intercept and slope of equation $\ln(-\ln(SR)) = cc + dd \cdot \ln(\ln(n))$.

In addition to the design plots, Figures 4.16 through 4.24 present the so-called “factor plots” to show the box-and-whisker plots, or simply boxplots, for inspecting the effect of factors on the response variables. Examining the analysis of variance (ANOVA) results also provides a quantitative way to identify significant factors that affect the response variables. The main effects on response variables listed below are based on the ANOVA results at a 5 percent significance level:

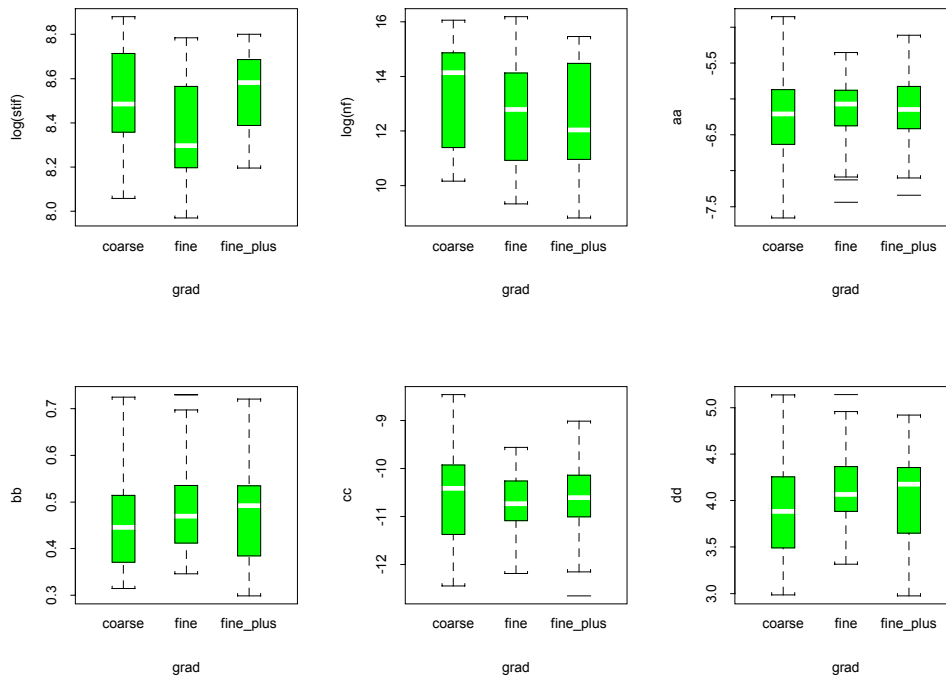

Figure 4.16. Boxplots for factor *grad* (fatigue tests at 20°C).

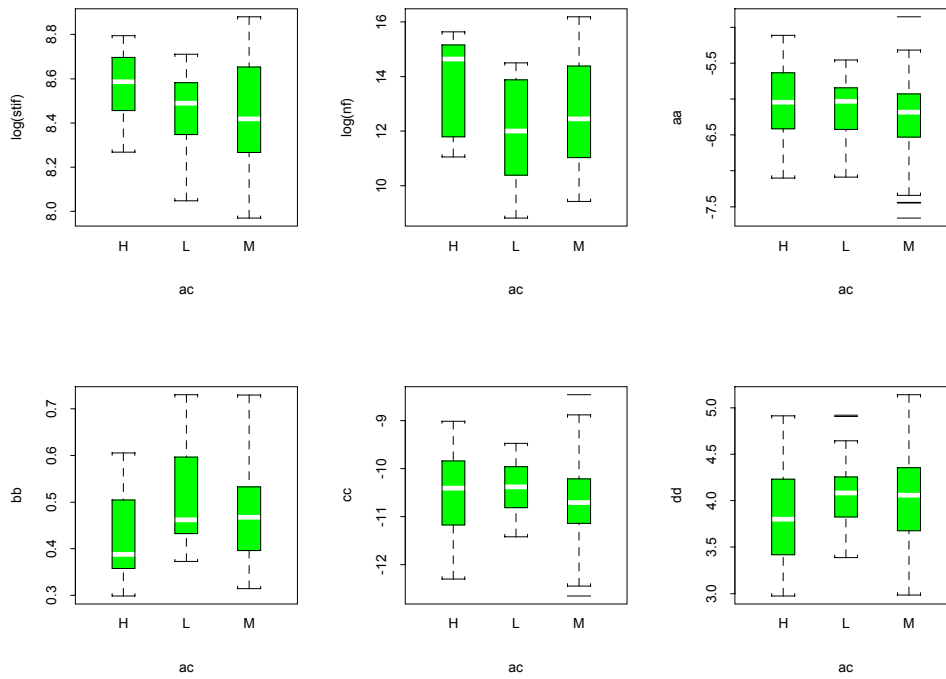

Figure 4.17. Boxplots for factor *ac* (fatigue tests at 20°C).

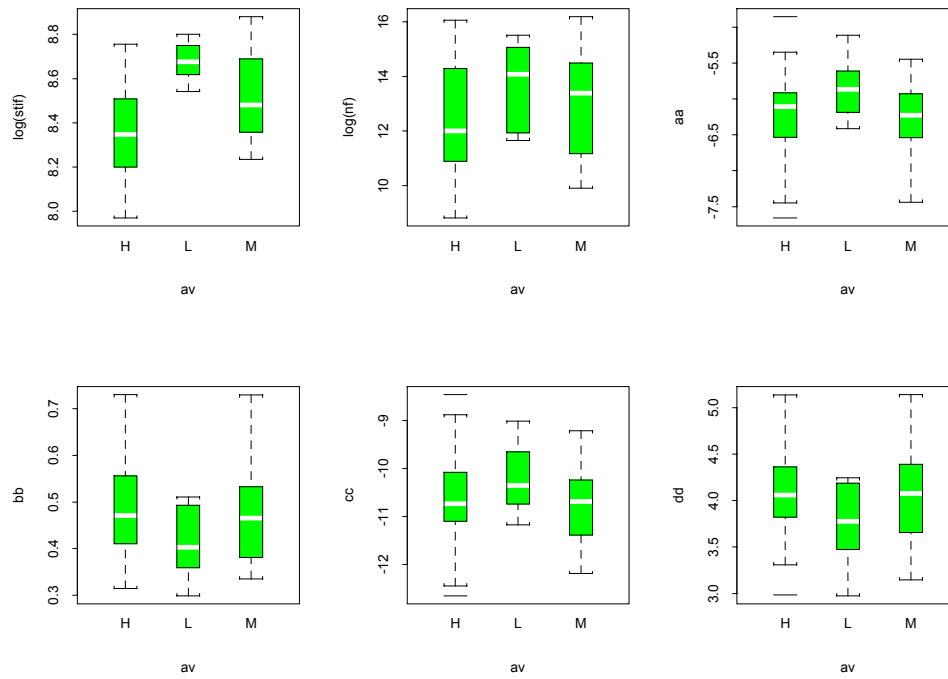

Figure 4.18. Boxplots for factor *av* (fatigue tests at 20°C).

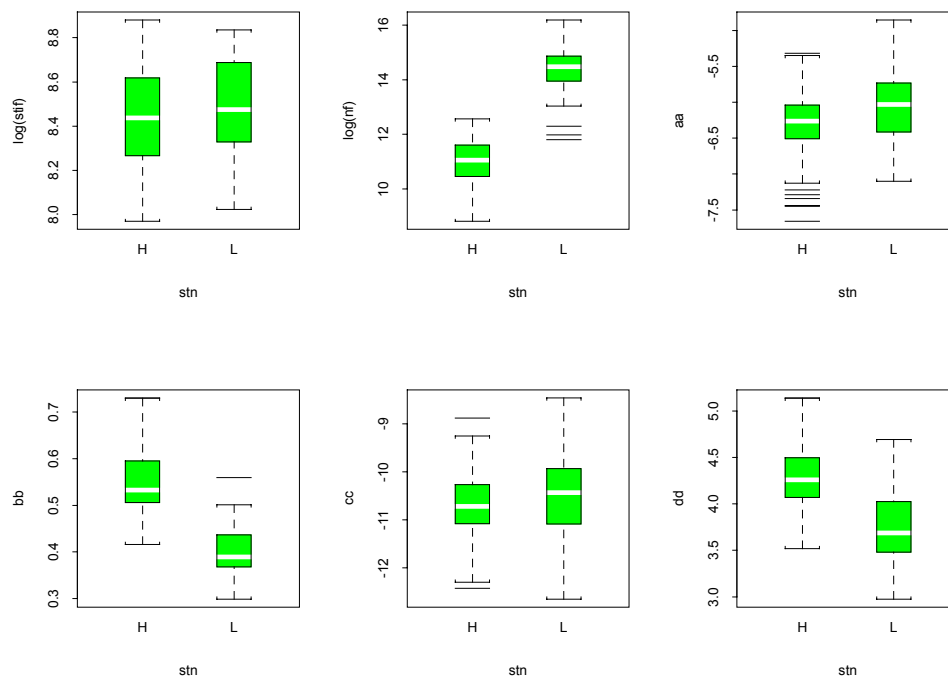

Figure 4.19. Boxplots for factor *stn* (fatigue tests at 20°C).

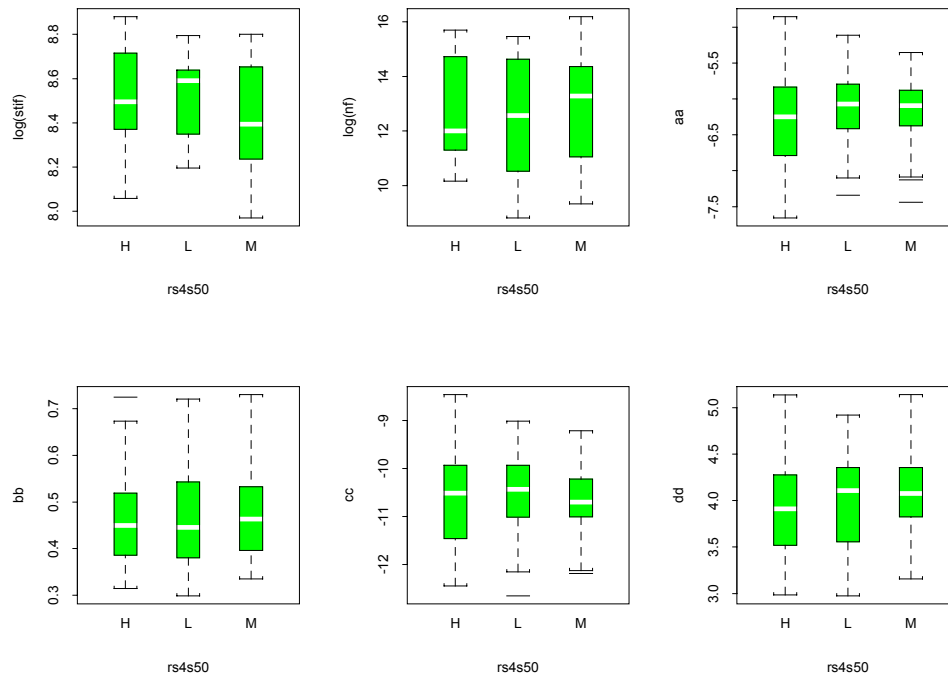

Figure 4.20. Boxplots for factor *rs4s50* (fatigue tests at 20°C).

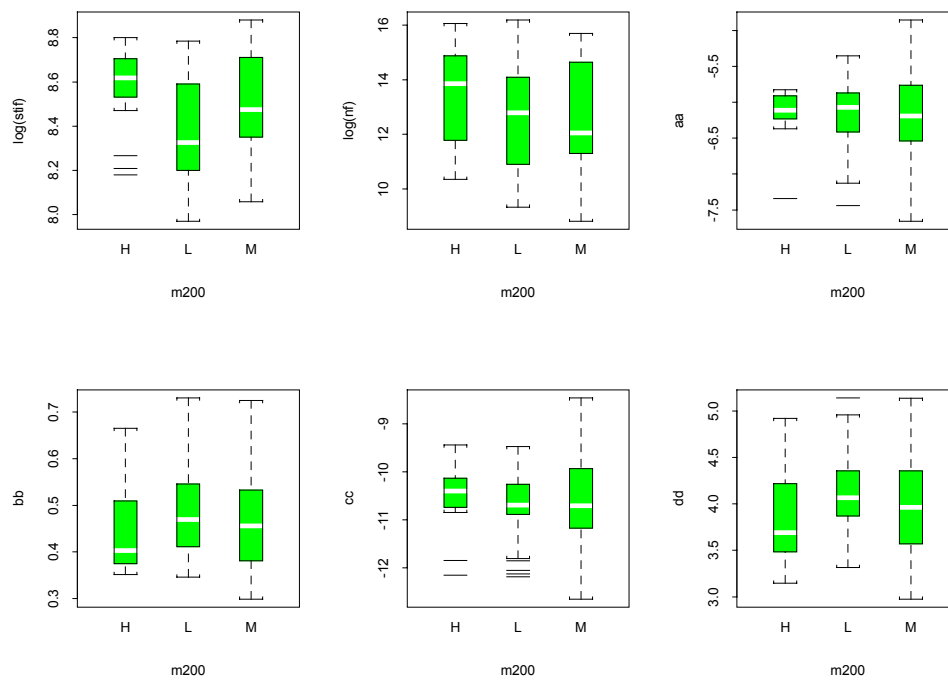

Figure 4.21. Boxplots for factor *m200* (fatigue tests at 20°C).

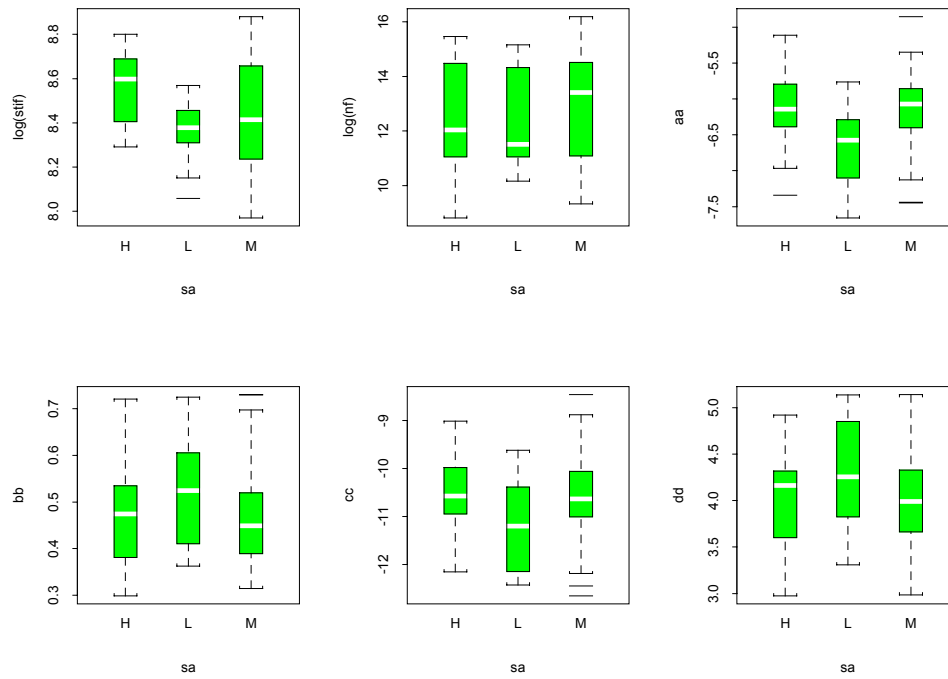

Figure 4.22. Boxplots for factor *sa* (fatigue tests at 20°C).

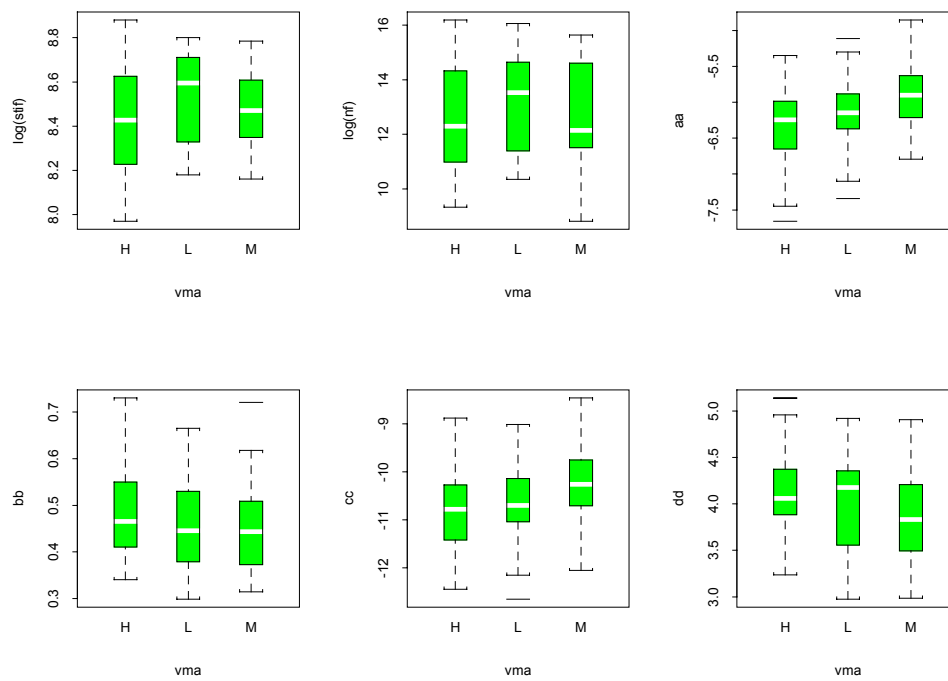

Figure 4.23. Boxplots for factor *vma* (fatigue tests at 20°C).

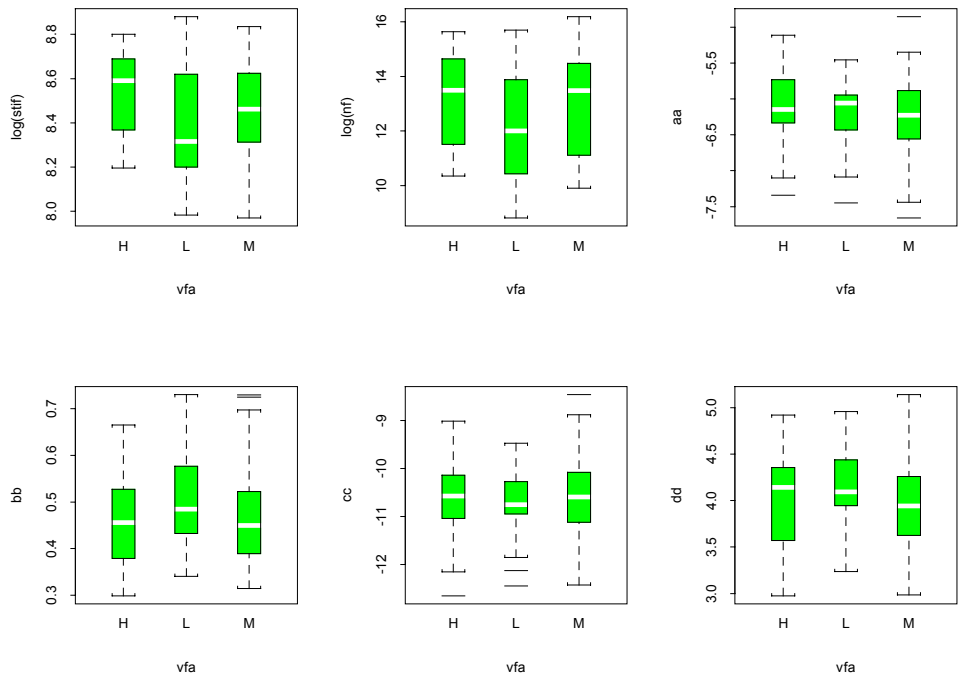

Figure 4.24. Boxplots for factor *vfa* (fatigue tests at 20°C).

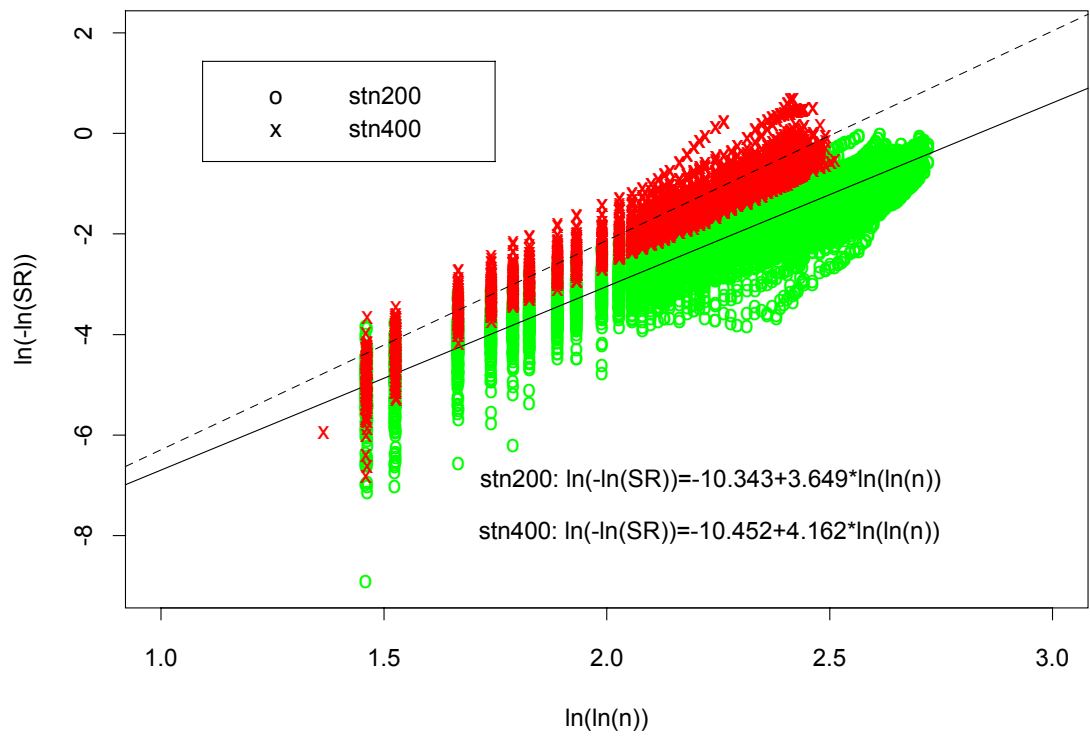

Figure 4.25. Weibull curves in two strain groups (fatigue tests at 20°C).

- *stif*: *grad*, *av*, *ac*, *stn*, *sa*, *vma*, and *vfa*.
- *nf*: *grad*, *av*, *stn*, and *rs4s50*.
- coefficient *aa*: *av*, *stn*, *sa*, and *vma*.
- coefficient *bb*: *av*, *stn*, and *sa*.
- coefficient *cc*: *av* and *sa*.
- coefficient *dd*: *grad*, *av*, *stn*, and *sa*.

Test for Parallelism for groups of 200 and 400 microstrain

From the previous discussion, it has been noted that the test strain level has a significant effect on the slopes of the Weibull curves. Thus, the data can be separated by test strain level and conduct an F-test to test the null hypothesis that the slopes of two groups are equal. The F-statistic is 25896 on 1 and 15944 degrees of freedom, resulting in a p-value of 0, that is to say, the hypothesis of parallelism is strongly rejected. In other words, the tensile strain level affects the fatigue damage process in a significant way. In Figure 4.25, the test results of 151 beams are separated into 200 and 400 microstrain groups and are presented as Weibull curves. The solid regression line is for the 200 microstrain group, the dotted line for the 400 microstrain group. The slopes fitted are 3.649 for the 200 microstrain group and 4.162 for the 400 microstrain group.

In Chapter 4.3 through Chapter 4.7, similar procedures of analysis will be followed, including figures and tables; however, only the topics of interest will be presented and summarized. The associated tables and figures will be included in Appendix A and Appendix B respectively. The factor plots for the other fatigue test types are not included.

In accordance with the identification procedure discussed above, a summary table (Table 4.2) was prepared for various types of fatigue tests. The criteria to mark the significant factors consist of two qualitative methods, design plots and factor plots, and two quantitative ways, a correlation matrix and ANOVA results. The threshold of identifying a significant factor from correlation coefficients is 0.4. A 5 percent significance level is set for the ANOVA results. If all these four criteria are check-marked in one independent variable, then this independent variable is considered a “very important” factor. If three criteria are check-marked, the factor is considered as being “important.” And lastly, if only one or two criteria are matched, it is deemed as being “less important.”

Using the above mentioned criteria, for this data set of fatigue tests at 20°C, several findings can be addressed in the following:

1. The *av* is a very important factor to the *Instif* and is also important to the other independent variables: *lnnf*, *aa*, *bb*, *cc*, and *dd*.
2. The *grad* is important to both *Instif* and *lnnf*. The *grad* shows no effect on the coefficients *aa*, *bb*, *cc*, and *dd*.
3. The *stn* is very important to *lnnf*, *bb*, and *dd*.
4. The *sa* is important to *Instif*, *aa*, *cc*, and *dd*, but less important to *bb*.

4.3 Temperature Susceptibility Fatigue Test (Field)

This data set includes the results of 35 fatigue beam tests on specimens cut from the top lifts of 10 WesTrack sections. The specimens are therefore field-mixed and field-compacted. Table A.4.2 summarizes the mix information, testing conditions, and the test results as well. The covariates and response variables considered are the same as those for the fatigue tests at 20°C but with the addition of a temperature variable, *temp*. The air-void contents were measured

Table 4.2 Summary Statistics of WesTrack Fatigue Tests

Type of Test	Response Variables	Covariates																																											
		<i>grad</i>				<i>ac</i>				<i>av</i>				<i>temp</i>				<i>stn</i>				<i>rs4s50</i>				<i>m200</i>				<i>sa</i>				<i>vma</i>				<i>yfa</i>							
		C	D	F	A	C	D	F	A	C	D	F	A	C	D	F	A	C	D	F	A	C	D	F	A	C	D	F	A	C	D	F	A	C	D	F	A								
Fatigue Test at 20 C	<i>Instif</i>		√	√	√			√	√	■	■	■	■																															√	√
	<i>lnmf</i>		√	√	√		√	√			√	√	√					■	■	■	■																								√
	<i>aa</i>										√	√	√																							√	√		√	√					
	<i>bb</i>						√	√			√	√	√					■	■	■	■															√	√								
	<i>cc</i>										√	√	√					■	■	■	■															√	√		√	√					
Temp. Susceptibility Fatigue Test (Field-mixed and Field-compacted)	<i>Instif</i>				√						√	√	√	■	■	■	■																								√				
	<i>lnmf</i>						√		√		√	√	√			√	√	■	■	■	■																√		√		√				
	<i>aa</i>										√	√		√		√	√																												
	<i>bb</i>						√	√						■	■	■	■					√		√	√																√				
	<i>cc</i>										√	√	√	■	■	■	■																												
Temp. Susceptibility Fatigue Test (Lab-mixed and Lab-compacted)	<i>Instif</i>				√									■	■	■	■																												
	<i>lnmf</i>			√	√								√	■	■	■	■					√														√			√	√					
	<i>aa</i>													■	■	■	■																												
	<i>bb</i>													■	■	■	■					√		√	√																				
	<i>cc</i>													■	■	■	■																												
High Temperature Fatigue Test	<i>Instif</i>										√	√	√	■	■	■	■																												
	<i>lnmf</i>		√	√											√	√	√	■	■	■	■						√													√	√				
	<i>aa</i>										√	√			√	√																				√	√								
	<i>bb</i>										√	√		√		√	√																												
	<i>cc</i>		√	√							√	√		√		√	√					√		√	√											√	√								
Fatigue Test with Various Gradations at 20 C	<i>Instif</i>		√	√	√						√	√			√	√		■	■	■	■					√		√	√		√					√	√								
	<i>lnmf</i>		√	√	√									■	■	■	■										√																		
	<i>aa</i>		√	√	√								√					■	■	■	■					√	√	√		√	√	√													
	<i>bb</i>		√	√	√									■	■	■	■					√		√	√					√	√	√													
	<i>cc</i>		√	√										■	■	■	■					√		√	√					√	√	√													
Pooled Fatigue Test	<i>Instif</i>				√			√		√		√		■	■	■	■																												
	<i>lnmf</i>				√			√		√		√		■	■	■	■																								√				
	<i>aa</i>													■	■	■	■																												
	<i>bb</i>							√						■	■	■	■																												
	<i>cc</i>													■	■	■	■																												

Note: 1. C: correlation matrix; D: Design plot; F: Factor plot; A: ANOVA result.
 2. The four-in-a-row diagonal shaded area means the covariate is “very important” to the corresponding response variable.

using the UCB air-voiding method. The variables *rs4s50*, *m200*, *sa*, *vma*, and *yfa* are according to the tables listed in Hand's dissertation (1998) as mentioned earlier. The ranges of covariates and six response variables (*Instif*, *lnnf*, *aa*, *bb*, *cc*, and *dd*) were listed in Table A.4.16. Figures B.4.1 through B.4.6 illustrate the associated design plots.

Fatigue test data were collected utilizing the conventional fatigue setup with a loading frequency of 10 Hz, various testing temperatures (5°C, 20°C, and 30°C), and strain levels including 200, 300, 400, and 800 microstrain. Through the identification procedure, the findings can be addressed from the summary Table 4.2 are:

1. The *temp* factor meets the criteria deeming it very important to most of the response variables, but only qualifies as important to *aa* and less important to *lnnf*.
2. The *stn* factor, as usual, is deemed very important to fatigue life *lnnf* but has no effect on the stiffness term *Instif*. The coefficients *aa*, *bb*, *cc*, and *dd* are affected by *stn* factor in a less important or important degree.
3. The *av* factor is less important to *Instif*, *lnnf*, and *cc*.
4. The variables associated with the gradation type have little or no effect on the response variables.

4.4 Temperature Susceptibility Fatigue Test (Laboratory)

The purpose of this test was to add to the database of the temperature susceptibility fatigue behavior of WesTrack mixes. The data set for this fatigue test consisted of 24 beams with two gradation types (CM and FM), two asphalt contents (5.7 percent and 5.4 percent), three temperatures (5°C, 20°C, and 30°C), and two strain levels (200 and 400 microstrain). The “M” in the designations of CM and FM stands for the target gradation compared with the high “H” (slightly finer than target) and “L” (slightly coarser than target) types of gradations mentioned in

Chapter 3. The CM is the coarse medium gradation of the WesTrack test sections. The FM is the fine medium gradation and is equivalent to the fine gradation of the WesTrack test sections. It should be noted that the covariates associated with the gradation type, such as *rs4s50*, *m200*, *sa*, *vma*, and *vfa*, for this specific experiment design, are completely dependent on the gradation variable, which is why the means of the factor levels of these covariates are the same. The associated design plots are listed in Figures B.4.7 through B.4.12. The detailed test results are summarized in Table A.4.3.

From Table 4.2, several findings can be summarized as follows,

1. The *temp* variable is very important to all the response variables and important to the *lnnf* term.
2. It has been widely recognized that the fatigue life *lnnf* is totally influenced by the *stn* term.
3. The effect of *av* term does not show its importance in this fatigue test, because the air-void contents of the beams are very close to each other. Therefore, conclusions related to the *av* term should not be drawn from this data set.
4. The *grad* term has no effect on any of the response variables except that the *grad* is a less important factor of the *lnnf*.

4.5 High Temperature Flexural Controlled-Strain Fatigue Test

In contrast to the literature of studies of high temperature fatigue for mechanical components, little data are available for the high temperature fatigue behavior of asphalt concrete.

The high temperature fatigue test is designed as a full factorial experiment with four factors, with each factor having two levels. The four factors are air-void content with two levels,

high (11 ± 1 percent) and low (6.6 ± 1 percent); aggregate gradation with coarse medium (CM) and fine medium (FM) levels; tensile strain containing the two levels of 200 and 400 microstrain; and test temperature with a 30°C and a 40°C level. Hence, the experiment design will contain $2^4 = 16$ runs. The percent asphalt content is fixed at 5.7 percent. For this specific experiment design, the variables $rs4s50$, $m200$, sa , vma , and vfa , all of which are associated with gradation type ($grad$), are statistically redundant in that they provide no more information than does $grad$.

According to previous experience in analyzing the WesTrack fatigue data, it was found that the obtained traditional fatigue equations of fine and fine-plus gradations exhibit no obvious difference. Thus, for the high temperature fatigue, only the CM and FM gradations were selected. The selection of the air-void contents was based on the statistical summary from previous tests of the mean air-void content. The temperature of 30°C was chosen to provide a replication of fatigue results for the two fatigue setups (conventional test setup versus modified test setup). Instead of choosing 45°C , which is reached in field pavements on a hot summer day, or 35°C , or including more temperatures, the main concern was the limited amount of available WesTrack material. As for the choosing of the two test strain levels, the main reasons lie in the compatibility to simulation results from a layered-elastic program and the completeness of the existing database.

Instead of using conventional measurements of deflection for a flexural beam test, i.e., LVDT readings, this test utilizes strain gages, which are attached on the top and bottom of both the asphalt concrete and the aluminum support, to conduct a real “controlled-strain” fatigue test. The main advantages of utilizing strain gages are to (1) verify the feasibility of applying linear elastic theory to an asphalt concrete beam, especially while subjected to high temperatures, (2) validate if asphalt concrete exhibits a nonlinear or bilinear stress-strain relationship at high

temperatures, and (3) perform a genuine controlled-strain flexural beam test. However, the LVDT was monitored during the test.

Figures 4.26 and 4.27 illustrate the test results for high temperature fatigue tests for the CM and FM mixes respectively. The Weibull curves for tests conducted at 40°C resemble a falling letter C in shape, especially for the FM mixes. The falling C shape implies that the fatigue damage rate is slowed down and flattens out and thus causes no further fatigue damage after a certain number of repetitions. It is conjectured that the FM mix is flexible at high temperature, thus making it hard to initiate and propagate cracks.

The test results are listed in Table A.4.4. The allied design plots are displayed in Figures B.4.13 through B.4.18. Table A.4.9 shows the correlation matrix. The ANOVA results are not shown here. According to these figures and tables, the appropriate check marks were put in the cell of significance in Table 4.2. Several observations from this table can be abstracted in the following:

1. The *lnstif* term is clearly affected by *temp* term. Temperature has no effect on the *lnnf* term. The *temp* term is less important to the coefficients *aa*, *bb*, *cc*, and *dd*.
2. The *stn* effect on the *lnnf* term is important in this high temperature fatigue test.
3. The *av* term is also important to the response variables *lnstif*, *aa*, *cc*, and *dd*.
4. The *grad* variable is less important to the response variables *lnnf*, *cc*, and *dd*.

The only clear fact emerging from this high temperature fatigue test is that the stiffness is definitely affected by temperature. However, for the WesTrack mixes, the fatigue life is insensitive to the temperature change. It should also be noted that at high temperatures the fatigue life of the FM is greater than that of the CM, whereas in previous experiments (fatigue

WesTrack Coarse Medium Mixes (CM)

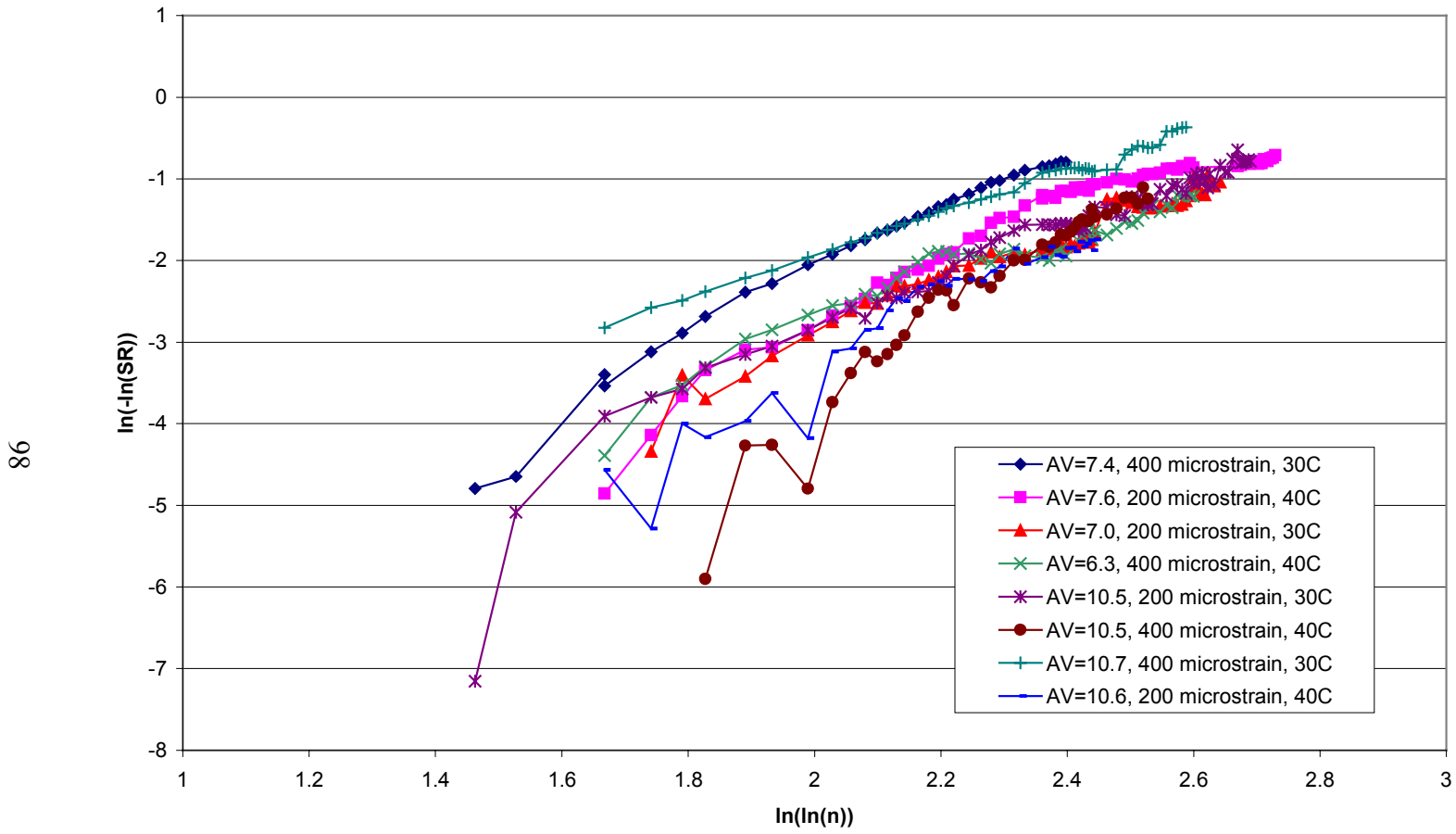

Figure 4.26. Test results of high temperature fatigue test for CM mixes.

WesTrack Fine Medium Mixes (FM)

66

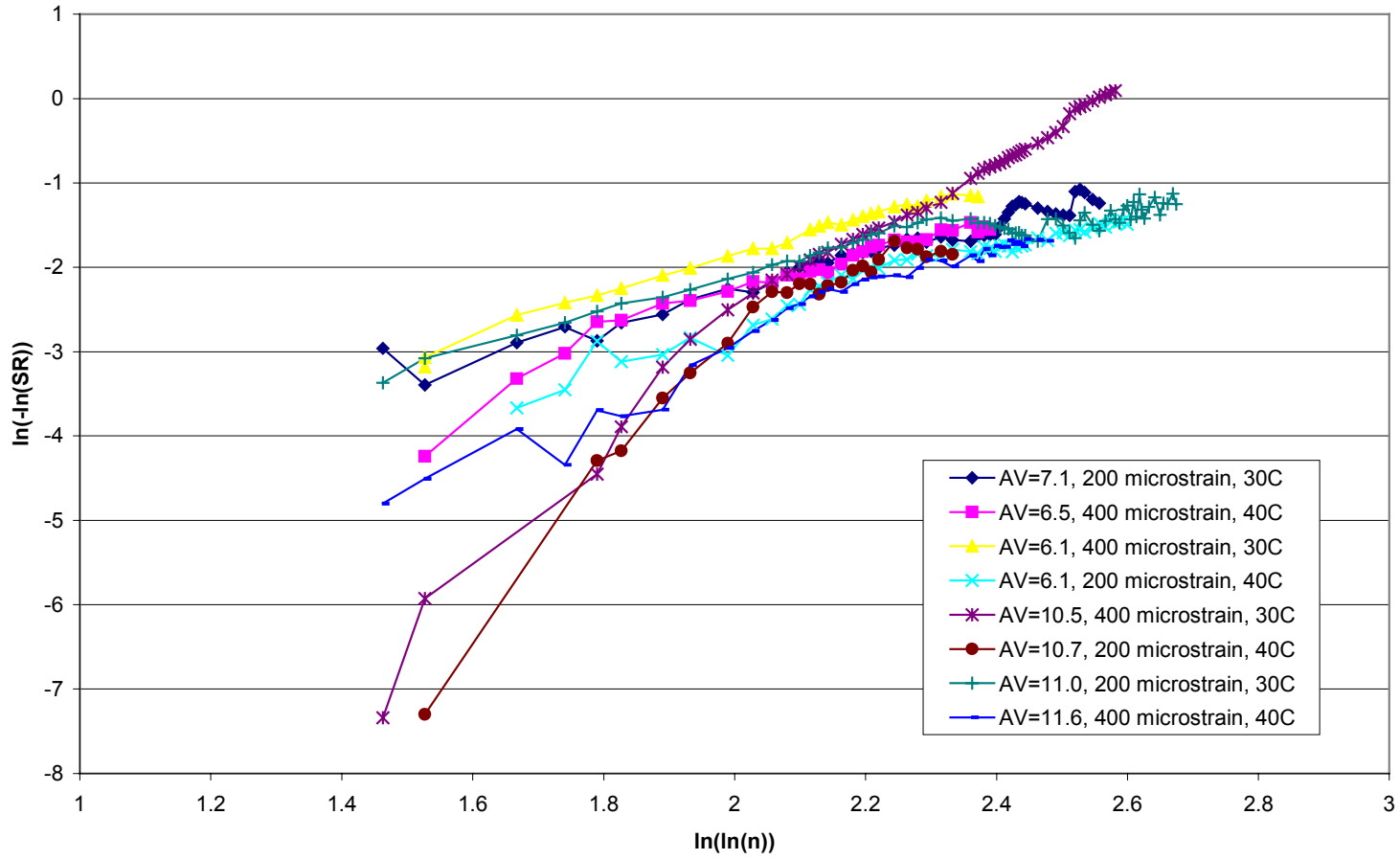

Figure 4.27. Test results of high temperature fatigue test for FM mixes.

tests at 20°C) the fatigue life of the FM was less than that of the CM. Reasons for these contradictory results at different temperatures are unclear at this time. Further experiments are recommended.

4.6 Fatigue Test with Various Gradation Types

The purpose of this test was to verify the effect of construction type variability of gradation (as occurs in the asphalt mix plant) on the fatigue performance. The gradation types utilized in this test were three types of coarse gradations: coarse medium (CM), coarse high (CH), and coarse low (CL), and three types of fine gradation: fine medium (FM), fine high (FH), and fine low (FL). The variables $rs4s50$, $m200$, sa , and vma , associated with gradation type ($grad$), are statistically redundant in that they provide no more information than does $grad$ for this experimental design. For the corresponding gradation curve information, please refer to Figures 3.10 to 3.13 and to Table 3.1. The test results are listed in Table A.4.5. The associated designs are displayed in Figures B.4.19 through B.4.24. Table A.4.10 presents the correlation matrix. The ANOVA results are not shown here. According to these figures and tables, the appropriate check marks were put in the cell of significance in Table 4.2. Several observations from this table can be abstracted in the following:

1. The $grad$ term is important to the terms $lnstif$, $lnnf aa$, and bb , but is less important to the coefficients cc and dd .
2. The stn term is very important to the terms $lnnf$ and bb .
3. There is no ac effect on any of the response variables because the asphalt contents are 5.7 percent for CL, CM, and CH and 5.4 % for FL, FM, and FH.
4. The av term is less important to the response variables $lnstif$, $lnnf$, aa , and dd .

5. Most of the gradation-associated variables, *rs4s50*, *m200*, *sa*, and *vma*, are important to the coefficients of *aa*, *bb*, *cc*, and *dd*. This indicates that the gradation is significant to the fatigue damage process.
6. The stiffness of the coarse gradation is more sensitive to gradation variation. Fatigue life has a similar sensitivity to change for both gradations.

4.7 Pooled Fatigue Tests

The pooled fatigue test results include the data sets of the fatigue tests at 20°C, the field-mixed and field-compacted temperature susceptibility fatigue tests, the laboratory-mixed and laboratory-compacted temperature susceptibility fatigue tests, and the high temperature fatigue tests. The fatigue tests with various gradation types were excluded. The associated design plots and factor plots are displayed in Figures B.4.25 through B.4.30. Table A.4.11 presents the correlation matrix. The ANOVA results are not shown here. The data range of this pooled fatigue test is listed in Table A.4.16.

Through the same identification procedure as before, the conclusions are summarized in the following:

1. The *temp* term is very important to the terms *lnstif*, *aa*, *bb*, *cc*, and *dd* and important to the *lnnf* term.
2. The *stn* term is very important to the *lnnf* and *bb* terms and is less important to the other response variables.
3. Compared with the effects of *stn* and *temp* terms, the effects caused by the other covariates seem to be negligible. It can be concluded that the effect of environmental factors on the pavement performance is more significant than the effect of material variables.

4.8 Conventional Fatigue Analysis for WesTrack Project

4.8.1 Model Selection

The conventional fatigue analysis is mainly the model selection of the initial stiffness and the fatigue life. The term “conventional” is applied here to stress the subtle differences that result from using the Weibull proportional hazards model. The purpose in conducting the conventional fatigue analysis is that the stiffness equation plays an important role in calculating the tensile strain in the Weibull dynamic approach. The model selection of fatigue life and stiffness is a trade-off procedure between engineering judgment and theoretical considerations. Therefore, the following sections use the same procedure to choose the most appropriate model to reflect the WesTrack data. Instead of utilizing the backward/forward selection procedure, the model selection discussed here will include the following steps:

- pairs plot to inspect the possible relationship amongst various variables,
- design plot and factor plot,
- correlation matrix of the covariates and response variables,
- ANOVA table to identify the significant terms,
- Mallow’s C_p (Seber 1977) to choose the best subset of the covariates,
- regression analysis,
- residual plot, and
- engineering judgment.

Because the model selection involved mountains of figure communications and judgments, only the final results and anything deemed important are presented in the associated sections.

4.8.2 Mallows' C_p Statistic

For the detailed derivation of Mallows' C_p statistic of model selection, please refer to the Seber's book (1977): *Linear Regression Analysis*. For comparing models, the mean square error criterion is used. Denote $X_{q \times 1} = (x_1, \dots, x_q)$, $X^{(p)} = (x_1, \dots, x_p)$, then for the regression

analysis, $\hat{Y}_p = X^{(p)'} \hat{\beta}_{sub}$ and $E[Y(X)] = X\beta$. Therefore, a meaningful quantity to minimize

could be $E\left[\left(\hat{Y}_p(X^{(p)}) - E[Y(X)]\right)^2\right]$. That is to say, search for the best sub-model such that the

above quantity is a minimum; however, this depends on X and might produce for every different X a different optimal p-parameter sub-model. Mallows suggested to minimize a scaled averaged

mean square errors, $\Delta_p = \frac{1}{\sigma^2} \sum_{i=1}^n E\left[(\hat{y}_{p,i} - E[y_i])^2\right]$. Through statistical manipulation, the estimate

of Δ_p , namely C_p , can be expressed as $C_p = \frac{SS_{res,p}}{\hat{\sigma}^2} + 2p - n$, where $SS_{res,p}$ is the residual sum

of the squares of the p-parameter sub-model, $\hat{\sigma}^2$ is the estimate of σ^2 , and n is the sample size.

How to interpret and apply this equation is of great importance to model selection. The

following presents some guidelines to interpreting the Mallows' C_p statistic:

- if no large systematic error exists, then $C_p \approx p$.
- if $C_p \gg p$, then it indicates a sub-model with large bias (usually $C_p > p$ or $C_p \approx p$); $C_p < p$ can happen due to variability.

- Consider a sub-model with small C_p and $C_p \approx p$.

Based on these guidelines and the `leaps()` command in S-PLUS, which computes the C_p values for all possible subsets of independent variables, the C_p plot, which is a plot of C_p statistic versus p , can be utilized to decide on the best sub-model.

4.8.3 Data Description

It is important to note that the conventional initial stiffness regression analysis will be utilized as one of the inputs to the Weibull dynamic approach when simulating the fatigue performance prediction for the WesTrack project mixes. Thus, the data include all the fatigue test data except the data from the fatigue tests with variations within a gradation (i.e., FH, FL, CL, and CH described in Chapter 4.6). All the data will be categorized by gradation type to comply with the mix characteristics of the 26 original constructed sections of WesTrack. The sample size, as well as the data range of the covariates and response variables of each category is listed in Table A.4.16. It is important to emphasize that examination should be limited by the parameters of the data range, as extrapolation can be misleading.

4.8.4 A Regression Example: Coarse Gradation

The conventional fatigue analysis using the laboratory fatigue data for WesTrack mixes categorizes the data into four groups based on the gradation types. It includes coarse, fine, fine-plus, and the combination of fine and fine-plus. Previous experience found no obvious difference between the fatigue performance of the fine and fine-plus gradations, therefore, the combined gradations group of fine and fine-plus is discussed as well. A detailed discussion of

how to use regression analysis on the coarse gradation is given as an example in the following paragraphs.

Initial Stiffness

From the correlation matrix of Table A.4.12, the *lnstif* has a strong negative correlation with the *temp* term and marginally negatively-correlated with the *av* term. In other words, a higher temperature or air-void content will result in a decrease in initial stiffness. The design plot (Figure B.4.31) shows that the *temp* and *stn* terms have a significant effect on the stiffness. However, based on engineering judgment, the *stn* term was not included. As can be seen in the factor plot of *stn* in Figure B.4.40, it shows that the sample sizes of the 300 and 800 microstrain level tests are too small, and that no evident difference exists between 200 and 400 microstrain levels. In other words, the visible difference in the design plot is due to data variation. Hence, the strain term will not be included in the formula.

The Mallows' C_p method picks *ac*, *av*, *temp*, *lnstn*, and *vma* as being the best set of covariates. As shown in Figure B.4.46, the selected set with size 6 (including the intercept term) has $C_p = 6.058$, which fits the best. The ANOVA inspection shows that the significant terms include *ac*, *av*, *temp*, *stn*, *rs4s50*, *sa*, and *vma*. No interaction terms are regarded as being important.

Through the previous discussion and investigation of regression fitting, the final model chosen for initial stiffness is,

$$E(\ln stif) = 10.6586 - \underset{(0.7081)}{0.2211} ac - \underset{(0.0927)}{0.0607} av - \underset{(0.0095)}{0.0633} temp + \underset{(0.0029)}{0.0703} vma$$

$$R^2 = 0.88$$

where the *stif* has the unit MPa and the remainder of the covariates have the same units as listed in Table 4.1.

Notice that the $E(\ln stif)$ term is the expected value of $\ln stif$ and the number in parentheses is the standard error of the parameter estimate. The residual standard error is 0.1824 on 73 degrees of freedom, $R^2 = 0.88$ and the F-statistic pertaining to the test of the hypothesis that all parameters equal zeros is 129.7 on 4 and 73 degrees of freedom, resulting in a p-value of 0. Accordingly, that hypothesis can be rejected.

A graphical representation of the residual analysis of the fit is summarized in Figure B.4.47. Figure B.4.47a shows a plot of estimated residuals versus fitted values. No evident pattern is observed in this figure indicating that the model is adequately specified for this data set. Figure B.4.47b plots the squared residuals against the fitted responses and exhibits a slightly upward positive dependence of estimated squared residuals on fitted responses, as shown by the lowess²-smoothed line. The assumption of homoskedasticity appears reasonable. Figures B.4.47c and B.4.47d show a normal probability plot and a histogram of the estimated residuals. The figures exhibit nominal skewness and short tails of the distribution. Roughly speaking, the distribution of estimated residuals is close to a normal distribution; in other words, the Gauss-Markov assumption of a normal distribution of the estimated residuals is borne out.

Fatigue Life

The correlation coefficients shown in the Table A.4.12 indicate the *lnnf* is negatively correlated with the *lnstn* term; however, the *temp* term is slightly positively-correlated with an indistinct correlation coefficient of 0.177. It is suspected that the fatigue life of the coarse

gradation is temperature-insensitive. As expected, the higher the strain level the lower the fatigue life. The design plot in Figure B.4.32 indicates that the *stn* term has the most significant effect on fatigue life, while the factors *av*, *temp*, *m200*, *vma*, and *vfa* have only a marginal effect on fatigue life. The factor plot in Figure B.4.39 shows the upward trend of *lnnf* as the temperature increases.

As shown in Figure B.4.48, the best subset chosen based on the Mallows' C_p criterion was the set of *av*, *temp*, *lnstn*, *sa*, and *vfa*, along with a C_p value of 6.220, which is close to the size 6. The ANOVA results identify *av*, *temp*, *stn*, and *m200* as terms having significant effect, as well as the interaction terms *av*temp* and *temp*stn*.

A compromise based on the previous discussions and regression fitting, the final model determined of fatigue life is:

$$E(\ln nf) = -25.0198 - 0.3716 av + 0.4661 temp - 6.1467 \ln stn - 0.7010 sa - 0.4623 vma \\ + 0.0123 av \cdot temp + 0.0646 temp \cdot \ln stn$$

(5.4150) (0.1372) (0.2110) (0.6148) (0.1771) (0.1168)
(0.0065) (0.0262)

$$R^2 = 0.92$$

where the covariates have the same definitions and units as described in Table 4.1.

The residual standard error of the fit is 0.5729 on 69 degrees of freedom, $R^2 = 0.92$ and the F-statistic associated with the test of the hypothesis that all the parameters equal zeros is 114.4 on 7 and 69 degrees of freedom, resulting in a p-value of 0, which refutes that hypothesis.

Figure B.4.49 plots the residual analysis of the fatigue life fit. No strong pattern is perceived in Figure B.4.49a indicating the model specification is correct. In Figure B.4.49b, the

² lowess is a S-PLUS command that gives a robust, local smooth of scatterplot data.

squared residuals seems to maintain a constant trend as seen by the lowess-smoothed line. Both the quantile-quantile (Q-Q) plot in Figure 4.49c and the histogram in Figure 4.49d comply with the Gauss-Markov assumptions.

Coefficients of Weibull Curves

The coefficients of Weibull curves shown in both design and factor plots (Figures B.4.33 through B.4.36 and Figures B.4.37 through B.4.45, respectively) indicate the significant effect of temperature on this coarse gradation mix. The intercepts, aa and cc , show a convex downward parabolic relation as the temperature increases and seem to have their maximum value around 30°C. The slopes, bb and dd , seem to display an upward parabolic relation as the temperature increase and have their minimum values occurring around 30°C.

When discussing the effect of strain levels on the coefficients of Weibull curves, the 300 and 800 microstrain tests will not be included as their sample size was limited. From the design plots and factor plots (Figures B.4.33 through B.4.36 and Figures B.4.37 through B.4.45, respectively), it seems that no difference is discernible in the effect of tensile strain to the intercept coefficients aa and cc when not considering the 300 and 800 microstrains. However, a slightly upward trend can be perceived, meaning the higher the strain level the larger the fatigue damage.

This same analysis procedure was applied to the fine, fine-plus, and the combination of the fine and the fine-plus gradations. The details of the regression analysis are not presented. Instead, only relevant observations and topics of interest are discussed.

Table 4.3 summarizes the model selection results for each gradation type. The final models of initial stiffness and fatigue life for each gradation are summarized in Table 4.4. In

Table 4.3 Model Selection of Stiffness and Fatigue Life of the WesTrack Project

Type of Gradation		Coarse					Fine					Fine-plus					Fine + Fine-plus						
model	covariate	C	D	F	A	M	C	D	F	A	M	C	D	F	A	M	C	D	F	A	M		
<i>Instif</i>	<i>grad</i>																				√	√	
	<i>ac</i>				√	√				√	√				√	√					√	√	
	<i>av</i>				√	√				√	√	√	√		√	√	√	√			√	√	
	<i>temp</i>																						
	<i>stn</i>				√	√				√	√				√	√					√	√	
	<i>rs4s50</i>				√						√					√						√	
	<i>m200</i>									√					√						√	√	
	<i>sa</i>				√						√												
	<i>vma</i>				√	√					√												
	<i>vfa</i>																√				√	√	
	Interaction term from ANOVA		none					none					none					<i>ac*av</i>					
<i>lnnf</i>	<i>grad</i>																						
	<i>ac</i>										√		√		√	√		√		√			
	<i>av</i>				√	√					√		√		√	√		√		√	√		
	<i>temp</i>		√	√	√	√		√	√	√	√					√		√	√	√	√	√	
	<i>stn</i>																						
	<i>rs4s50</i>														√								
	<i>m200</i>		√		√										√	√						√	
	<i>sa</i>					√					√										√		
	<i>vma</i>		√			√					√					√							
	<i>vfa</i>		√					√			√		√			√		√		√	√	√	
	Interaction term from ANOVA		<i>av*temp, temp*stn</i>					none					<i>av*stn, av*rs4s50, av*m200</i>					<i>av*temp, temp*m200</i>					

Note: 1. C: correlation matrix; D: design plot; F: factor plot; A: ANOVA result; M: Mallows' Cp.

2. The five-in-a-row diagonal shaded area means the covariate is "very important" to the corresponding response variable.

Table 4.4 Final Regression Models of Stiffness and Fatigue Life of the WesTrack Project

Regression Model for Stiffness		
Type of Gradation	Model Specification	R^2
Coarse	$E(\ln stif) = 10.6586 - 0.2211ac - 0.0607av - 0.0633temp + 0.0703vma$ (0.7081) (0.0927) (0.0095) (0.0029) (0.0306)	0.88
Fine	$E(\ln stif) = 9.9468 - 0.1752ac - 0.0846av - 0.0570temp + 0.3898rs4s50$ (0.5593) (0.0480) (0.0092) (0.0026) (0.1238)	0.89
Fine plus	$E(\ln stif) = 12.1807 - 0.3409ac - 0.0980av - 0.0595temp$ (0.3075) (0.0455) (0.0087) (0.0036)	0.86
Fine + Fine plus	$E(\ln stif) = 11.3220 - 0.2133ac - 0.0808av - 0.0548temp$ (0.1941) (0.0304) (0.0055) (0.0021)	0.87
Regression Model for Fatigue Life		
Type of Gradation	Model Specification	R^2
Coarse	$E(\ln nf) = -25.0198 - 0.3716av + 0.4661temp - 6.1467 \ln stn - 0.7010sa - 0.4623vma$ (5.4150) (0.1372) (0.2110) (0.6148) (0.1771) (0.1168) $+ 0.0123av \cdot temp + 0.0646temp \cdot \ln stn$ (0.0065) (0.0262)	0.92
Fine	$E(\ln nf) = -22.9544 - 0.2030av - 0.1805temp + 0.0071temp^2 - 4.6276 \ln stn$ (2.3022) (0.0394) (0.0422) (0.0010) (0.2708)	0.85
Fine plus	$E(\ln nf) = -25.1391 + 0.3354av - 0.2175av - 4.7373 \ln stn - 0.2484m200$ (1.9349) (0.1747) (0.0338) (0.1771) (0.1391)	0.93
Fine + Fine plus	$E(\ln nf) = -33.4822 - 0.1206av + 0.4443temp - 4.6667 \ln stn + 1.0204m200 + 0.0342vfa$ (2.1271) (0.0319) (0.0655) (0.1823) (0.3033) (0.0074) $- 0.0779m200 \cdot temp$ (0.0136)	0.86

Note: 1. The “E” in model specification stands for “Expected”.
2. The number inside the parentheses is the standard error of regression coefficient.

Table 4.3 five statistical measures are utilized as tools to identify the significant factors in model selection. The five statistical measures consist of a correlation matrix designated as C, a design plot (D), a factor plot (F), ANOVA results (A), and Mallow's C_p method (M). If a covariate is identified as significant by one of the statistical analysis, a check is marked in the box that applies. If five checks are marked for a covariate, then the covariate will be identified as "very important". If three to four boxes are checked, then the covariate will be regarded as "important". If only one or two boxes are checked, it is considered as being a "less important" covariate. The criterion of correlation coefficient to identify the significant factor is set at 0.4. Rather than a quantitative measurement, the criteria for using design and factor plots is subjective and qualitative. Table 4.5 lists the summary statistics of the Weibull coefficients based on gradation types. It uses the same identification procedure as in Table 4.2 to verify the important factors that affect the fatigue damage process.

4.8.5 Regression Analysis Results

Using the same procedure of model selection and regression analysis as shown in Chapter 4.8.4, the identification of significant factors for model selection and the final regression models of initial stiffness and fatigue life are listed in Tables 4.2 and Table 4.4, respectively. The identification of significant factors relating to the fatigue damage process (Weibull equation) is shown in Table 4.5. Table 4.6 presents the associated figures and tables used in the factor identification, model selection, and regression analysis. Notice that the factor plots are listed only for coarse gradation.

From the model selection procedure, as tabulated in Table 4.4, several findings may be addressed as follows:

Table 4.5 Summary Statistics of Weibull Coefficients

Type of Gradation	Response Variables	Covariates																																															
		<i>grad</i>				<i>ac</i>				<i>av</i>				<i>temp</i>				<i>stn</i>				<i>rs4s50</i>				<i>m200</i>				<i>sa</i>				<i>vma</i>				<i>vfa</i>											
		C	D	F	A	C	D	F	A	C	D	F	A	C	D	F	A	C	D	F	A	C	D	F	A	C	D	F	A	C	D	F	A	C	D	F	A	C	D	F	A								
Coarse	<i>aa</i>																																																
	<i>bb</i>																	√				√																											
	<i>cc</i>																																																
	<i>dd</i>																																																
Fine	<i>aa</i>																																																
	<i>bb</i>																																																
	<i>cc</i>																																																
	<i>dd</i>																																																
Fine-plus	<i>aa</i>																																																
	<i>bb</i>																																																
	<i>cc</i>																																																
	<i>dd</i>																																																
Fine + Fine-plus	<i>aa</i>																																																
	<i>bb</i>																																																
	<i>cc</i>																																																
	<i>dd</i>																																																

Note: 1. C: correlation matrix; D: Design plot; F: Factor plot; A: ANOVA result.

2. The four-in-a-row diagonal shaded area means the covariate is “very important” to the corresponding response variable.

Table 4.6 Associated Figures and Tables for Regression Analysis

Gradation Type	Figures				Tables
	Design Plot	Factor Plot	Mallow's Cp Plot	Residual Plot	Correlation Matrix
Coarse	B.4.31-B.4.36	B.4.37-B.4.45	B.4.46, B.4.48	B.4.47, B.4.49	A.4.12
Fine	B.4.50-B.4.55	NA	B.4.56, B.4.58	B.4.57, B.4.59	A.4.13
Fine-Plus	B.4.60-B.4.65	NA	B.4.66, B.4.68	B.4.67, B.4.69	A.4.14
Fine and Fine-Plus	B.4.70-B.4.75	NA	B.4.76, B.4.78	B.4.77, B.4.79	A.4.15

1. It is obvious that the significance of the effect of temperature on initial stiffness is similar to that of the effect of strain on fatigue life. Both factors are very important.
2. The av is an important factor when considering the initial stiffness of fine-plus and the combination of fine and fine-plus gradations.
3. No interaction terms are required when conducting the model selection of initial stiffness, except that the interaction term of ac and av ($ac*av$) is needed for the combination of fine and fine-plus.
4. The temperature factor is important to the gradations of coarse, fine, and the combination of fine and fine-plus, when considering the model of fatigue life.
5. The ac and av are two important factors of the fine-plus gradation in considering the model of fatigue life.
6. The model selection of fatigue life involves various interaction terms, except the fine gradation, for which no interaction term is needed as it is insignificant to the results.

The final regression models of initial stiffness and fatigue life are shown in Table 4.4.

Several findings can be summarized as follows:

1. In the stiffness models, *ac*, *av*, and *temp* are the basic covariates constructing the model, in addition, all the coefficients for these three covariates are negative, i.e., the higher the amount of these covariates the lower the stiffness.
2. As for the models of fatigue life, notice that a squared term of temperature is added in the model of the fine gradation whereas no temperature term is presented in the model of the fine-plus gradation; that is to say, statistically, the fine-plus mixes are temperature-insensitive.

The regression models of initial stiffness in the coarse and in the combination of fine and fine-plus are going to be used in the Weibull simulation in Chapter 7.

Table 4.5 lists the results of identifying the significant factors of fatigue damage process.

Several findings can be addressed here:

1. Even for various gradation types, the temperature term profoundly affects not only the slopes of the Weibull curves but also the intercepts of the Weibull curves.
2. The strain effect mostly affects the slopes of the Weibull curves for all gradation types.
3. The *ac* effect is much more important to the fine-plus gradation than to any other gradation.

4.9 Flexural Frequency Sweep Test

4.9.1 Test Results

There are two objectives for the flexural frequency sweep test as put forth in the test plan in Chapter 3: (1) determining the compatibility between a modified and a conventional flexural beam setup, and (2) obtaining the flexural stiffness response of asphalt concrete at high

temperatures with various loading frequencies. Only four beams were tested, two were coarse medium (CM) mixes and two were fine medium (FM) mixes. The frequency sweep test with the 40°C-30°C-20°C sequence was conducted with a modified fatigue setup and the results were analyzed using the measurements obtained from the strain gage. A piece of S-PLUS code shown in Appendix C was written to complete the analysis. The frequency sweep test with the 30°C-20°C-5°C sequence was conducted with the conventional fatigue setup and analyzed using LVDT measurements. Table A.4.18 summarizes the test results. Figures 4.28 and 4.29 present the test results for the FM and CM mixes, respectively.

Analysis of the frequency test data suggests the following:

1. In general, the FM mix has a higher value of complex modulus than that of the CM mix with respect to the temperature and loading frequency.
2. For the CM mix, the results of the modified and conventional fatigue setups are highly compatible above a 1 Hz loading frequency at 20°C and 30°C.
3. For the FM mix, the results of the two fatigue setups present a consistent trend but with a tolerable vertical shift above a 0.5 Hz loading frequency at 20°C and 30°C. It is the modified fatigue setup, however, that has a higher estimation.
4. For both mixes, the discrepancies at low loading frequencies, namely from 0.01 Hz to 0.1 Hz, are considerable. Fortunately, the loading frequencies located in this range are outside the area of interest in terms of the vehicle speeds associated with highways.
5. The test method and the algorithm utilized in calculating the complex modulus of asphalt concrete in the modified fatigue setup are acceptable.

Frequency Sweep Test for FM mixes (300 microstrain)

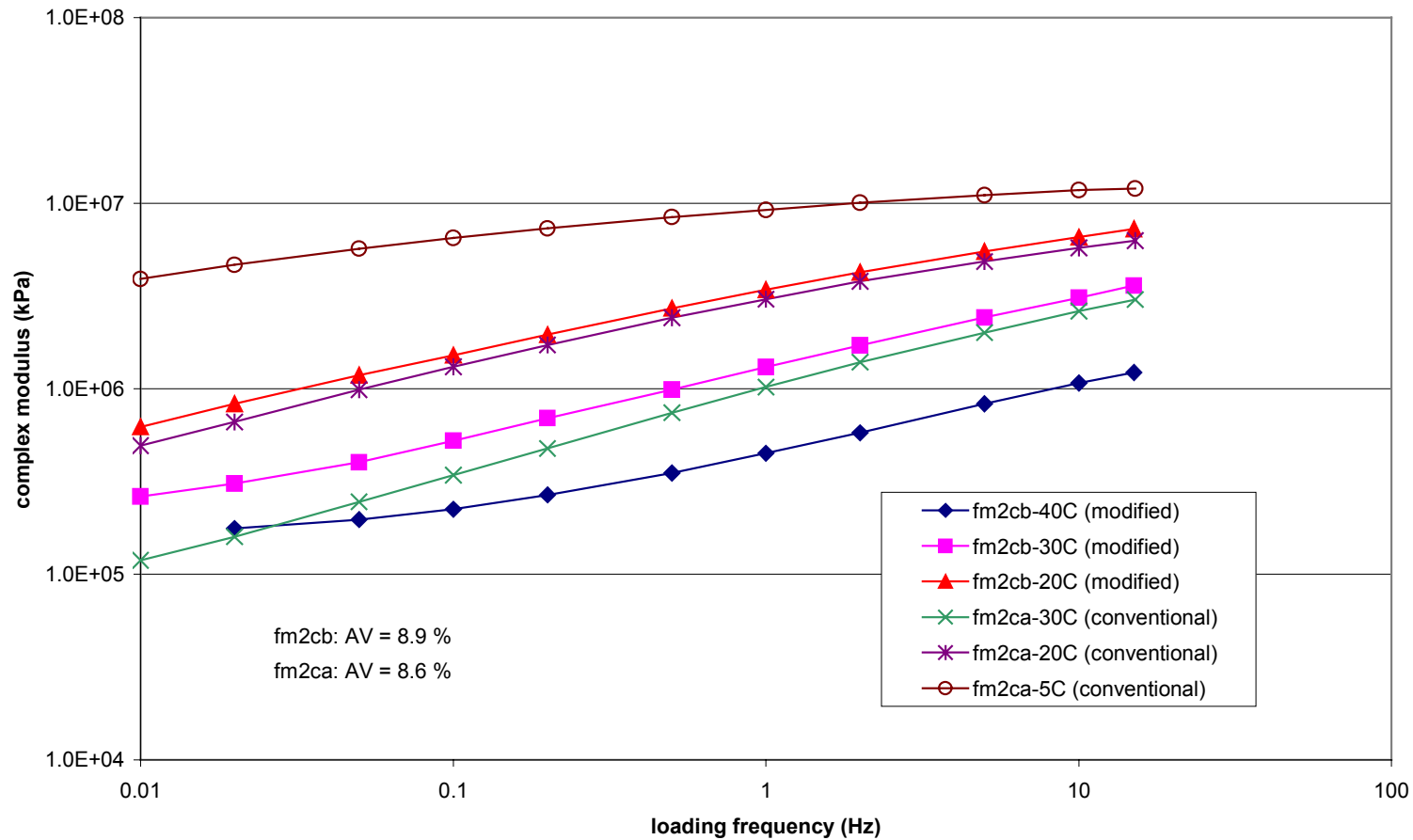

Figure 4.28. Flexural frequency sweep test results for FM mixes at 300 microstrain.

Frequency Sweep Test for CM mixes (300 microstrain)

117

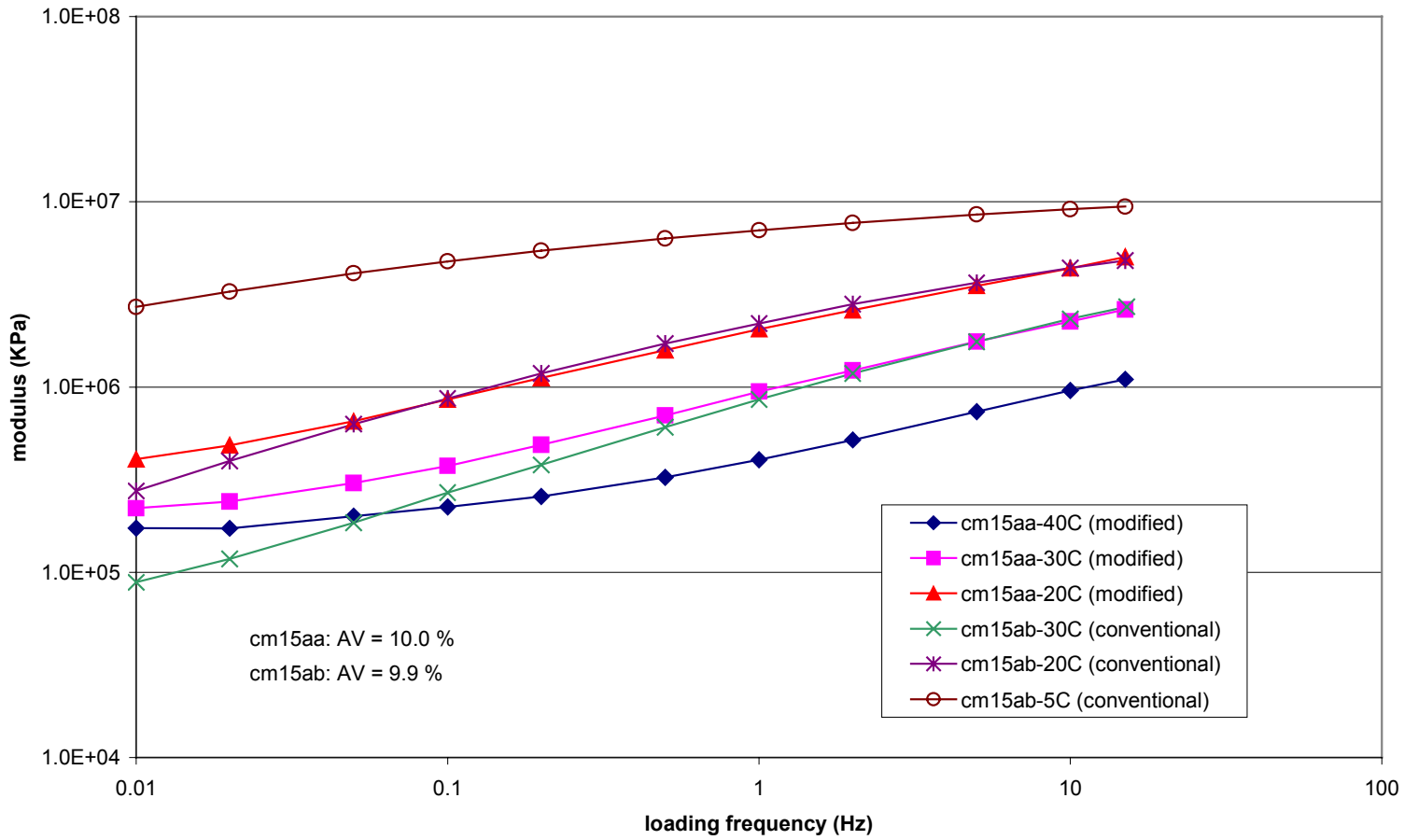

Figure 4.29. Flexural frequency sweep test results for CM mixes at 300 microstrain.

The frequency sweep test results provide information about the complex moduli at various temperatures and various loading frequencies. More importantly, according to the results, a mathematical function can be used to describe the phenomenon, thus making it possible to include the function into the recursive pavement analysis program for the interaction effect of different vehicle speeds and temperatures on the complex moduli of asphalt concrete. The following paragraphs will illustrate one of the possible mathematical functions that can fit the frequency sweep test results.

4.9.2 Fitting with Gamma Distribution Function

The WLF function (Ferry 1980) is widely utilized to find the Master Curve for some reference temperatures. Since the frequencies of interest for a normal highway loading conditions are not found in the extreme values, defining the master curve becomes unnecessary in practice. The main purpose in conducting the nonlinear fitting of the data of frequency sweep tests is to find a suitable mathematical function that can systematically represent the relationship of the complex modulus and loading frequency at various temperatures. The following is a discussion of one of the alternatives. The ability to define a mathematical form for this relationship carries with it the advantage that it can be easily coded for fatigue performance simulations. However, this relationship will not be included in the Weibull dynamic approach at this moment. It is only a conceptual presentation of the possibility of numerically expressing this relationship so that it can be programmed in the simulation approach.

The distribution function of the gamma distribution with shape parameter n (a positive number) and scale parameter β is expressed in the following form (Stone 1996):

$$F(y) = \begin{cases} 1 - e^{-y/\beta} \cdot \sum_{m=0}^{n-1} \frac{y^m}{\beta^m m!} & , y \geq 0 \\ 0 & , y < 0 \end{cases}$$

Figures 4.30 and 4.31 display how the shape and scale parameters interpret the family curves of gamma distribution function. As the same scale parameters are extended from 0.1 to 2 for the shape parameters $n = 2$ and $n = 5$, the difference between these two sets of family curves is readily perceived. It should be noted that the characteristics of the distribution function are (1) the values of y ranged from 0 to 1, (2) the x value starts from zero, and (3) the y value is asymptotic to one as x increases. These aspects of a distribution function are employed in constructing the nonlinear fitting.

The procedure for nonlinear fitting of frequency sweep test data is as follows:

1. Take the natural logarithm for both frequency and complex modulus, i.e., $\ln(\omega)$ and $\ln(S)$.
2. Shift the frequency sweep curve in both x and y directions based on the lowest frequency and the complex modulus at the lowest frequency so that the frequency and complex modulus will start the value from zero, i.e., $\ln(\omega)^* = \ln(\omega) - \ln(\omega_0)$ and $\ln(S)^* = \ln(S) - \ln(S_0)$.
3. Conduct nonlinear fitting on the following formula:

$$\ln(S)^* \sim A \cdot \left(1 - e^{-\ln(\omega)^*/\beta} \cdot \sum_{m=0}^{n-1} \frac{(\ln(\omega)^*)^m}{\beta^m m!}\right)$$

(It is better to fix the n value and estimate the amplitude A and scale parameter β only.)

4. Once satisfactory fitting results are obtained, shift back to the original coordinate system, i.e., the fitting pairs of points are of the form:

$$\left(\ln(\omega), \ln(S_0) + \hat{A} \cdot \left(1 - e^{-\ln(\omega)^* / \hat{\beta}} \cdot \sum_{m=0}^{\hat{n}-1} \frac{(\ln(\omega)^*)^m}{\hat{\beta}^m m!} \right) \right).$$

shape parameter: n=2; scale parameter: beta=varied

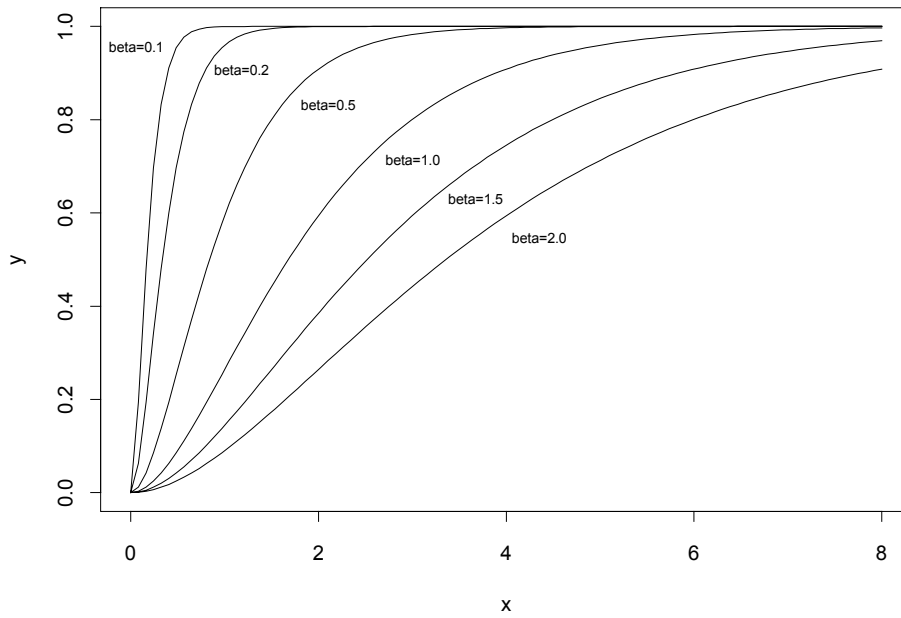

Figure 4.30. Gamma distribution curves with shape parameter $n = 2$ and scale parameters $\beta = 0.1, 0.2, 0.5, 1, 1.5,$ and 2 .

shape parameter: $n=5$; scale parameter: β =varied

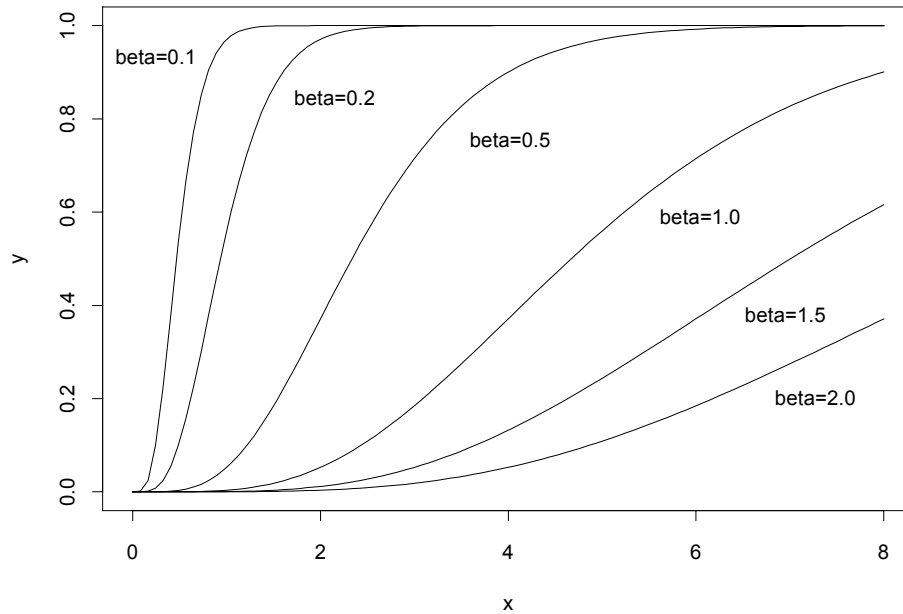

Figure 4.31. Gamma distribution curves with shape parameter $n = 5$ and scale parameters $\beta = 0.1, 0.2, 0.5, 1, 1.5,$ and 2 .

Figures 4.32 and 4.33 demonstrate the appropriate nonlinear fit utilizing the Gamma distribution function for tests conducted with the modified and conventional fatigue test setups respectively. The shape parameter $n = 2$ was used for the modified test setup; $n = 3$ was used for the conventional test setup. It was found that the $\hat{A}s$ and $\hat{\beta}s$ are increased as the temperature increases.

4.10 Varied-Strain Fatigue Test

4.10.1 The Strain Effect on Weibull Curves

In the summary Table 4.2, it was found that the strain effect of the fatigue test at 20°C is significant for coefficients bb and dd , which are the slopes of the Weibull curves. Notice that there are only two strain levels of 200 and 400 microstrains. In the hypothesis testing of

parallelism (Weibull curves of the same slopes) for these two strain groups (as discussed in Chapter 4.2), it was indicated that different strains cause various fatigue damage rates. At the same test temperature (20°C), no significant strain effect was perceived for the coefficients of aa and cc , which are the intercepts of Weibull curves.

From the temperature susceptibility fatigue test, three fine-plus fatigue test results, designated as WT12FT, WT12DT, and WT21BT, are plotted together in terms of $\ln(-\ln(SR))$ versus $\ln(\ln(n))$, as illustrated in Figure 4.34. The detailed mix information of these three beams is listed in Table A.4.2. They were conducted at 20°C and at three strain levels of 200, 300, and 400 microstrains. The three Weibull curves are straight and mutually parallel, indicating that the Weibull assumption is tenable. As visualized in Figure 4.34, it displays a contradictory result as compared with the strain effect summarized in Table 4.2, i.e., the strain effect should reflect on the change of slopes of the Weibull curves. The distance between the 200 and 300 microstrain curves is distinctly greater than the distance between the 300 and 400 microstrain curves. It would seem that, for fine-plus mixes, the strain effect affects the intercept of the Weibull curves rather than the slopes. It is suspected that this phenomenon is mix-dependent. The plot of stiffness ratio versus repetition and the plot of stiffness versus repetition are shown in Figures 4.35 and 4.36, respectively.

4.10.2 A Hypothesis of Strain-Caused Fatigue Damage

Whether the strain's effect is upon the slopes or the intercepts of the Weibull curves, it is acknowledged that when the strain level changes the fatigue damage process must be changed accordingly. The question then is how to model or describe the fatigue damage process.

Gamma Distribution Function-Nonlinear Fitting

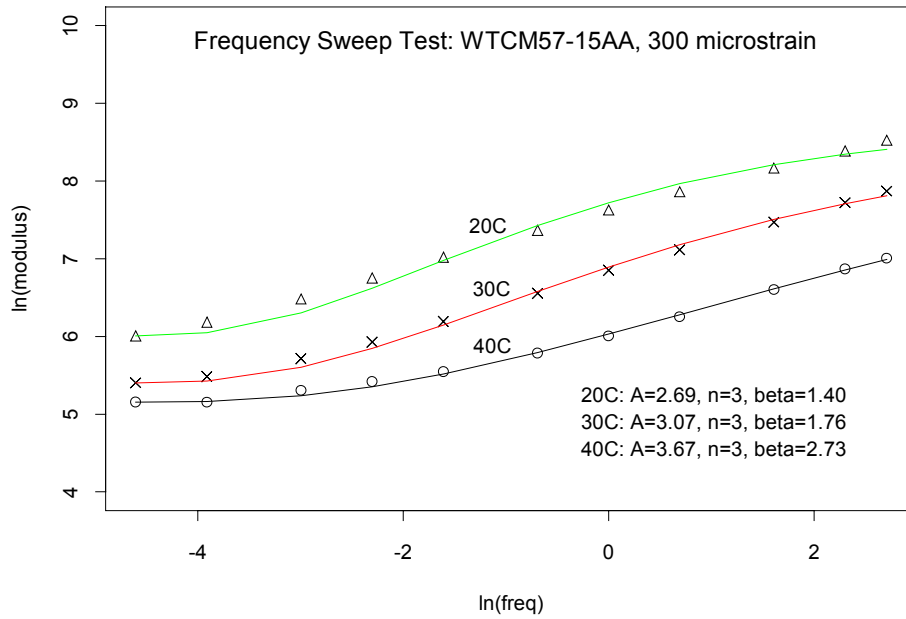

Figure 4.32. Nonlinear fitting of flexural frequency sweep test using Gamma distribution function (modified fatigue test setup).

Gamma Distribution Function-Nonlinear Fitting

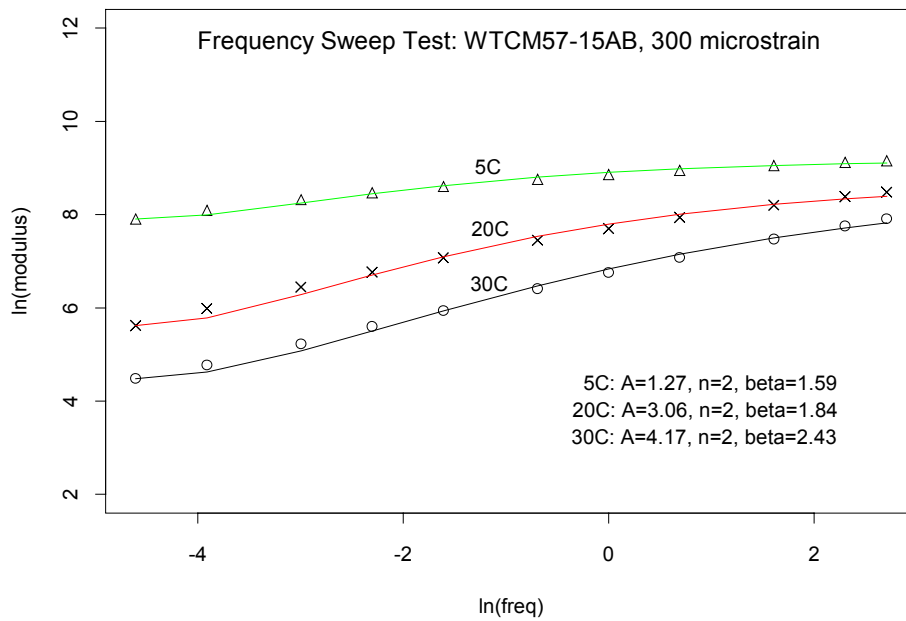

Figure 4.33. Nonlinear fitting of flexural frequency sweep test using Gamma distribution function (conventional fatigue test setup).

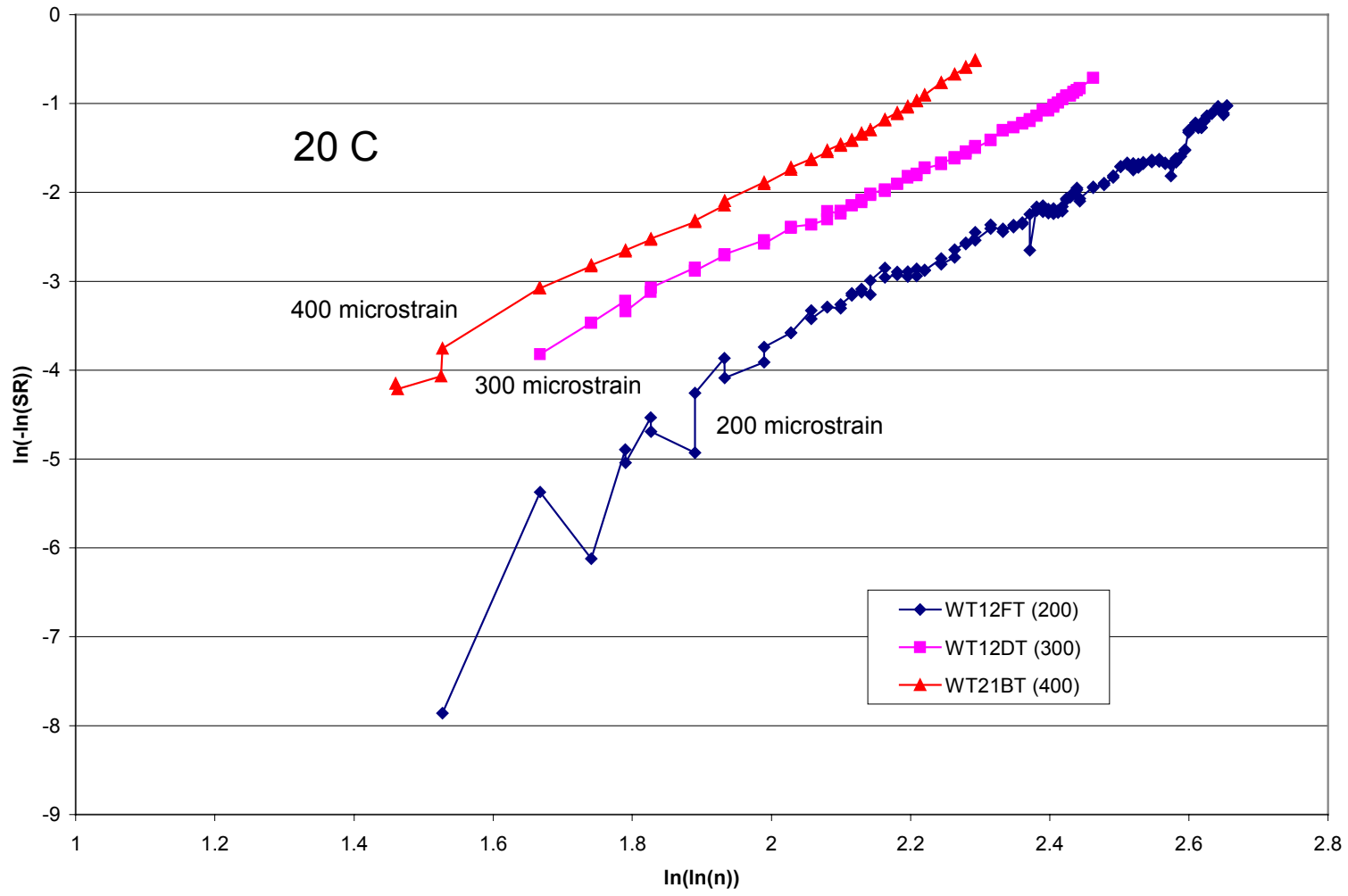

Figure 4.34. Weibull curves at various strain levels.

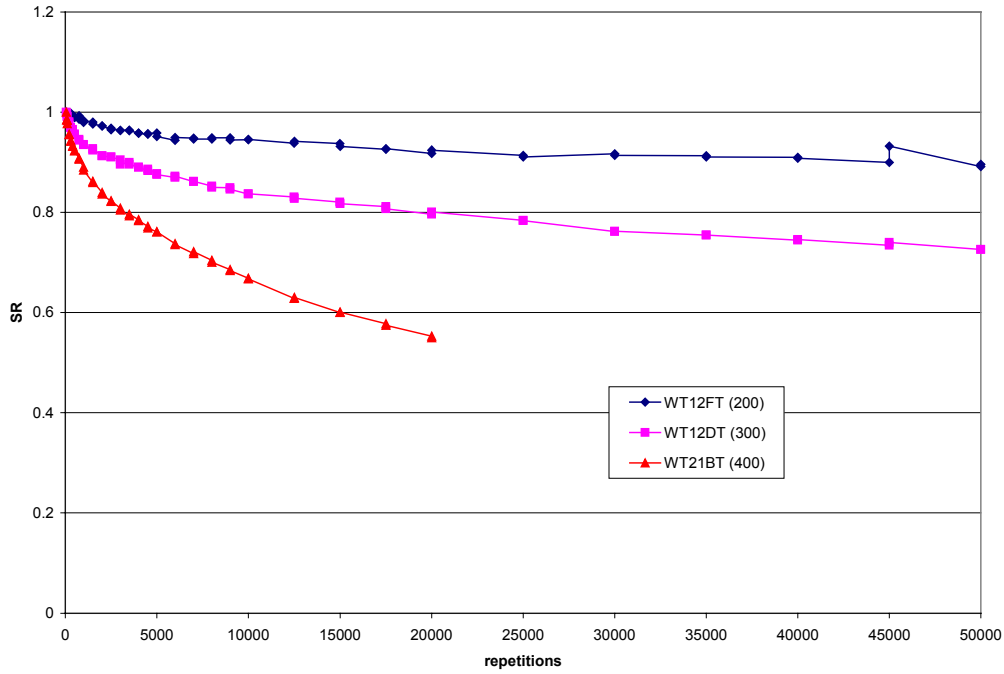

Figure 4.35. Stiffness deterioration curves at various strains in terms of SR versus repetition.

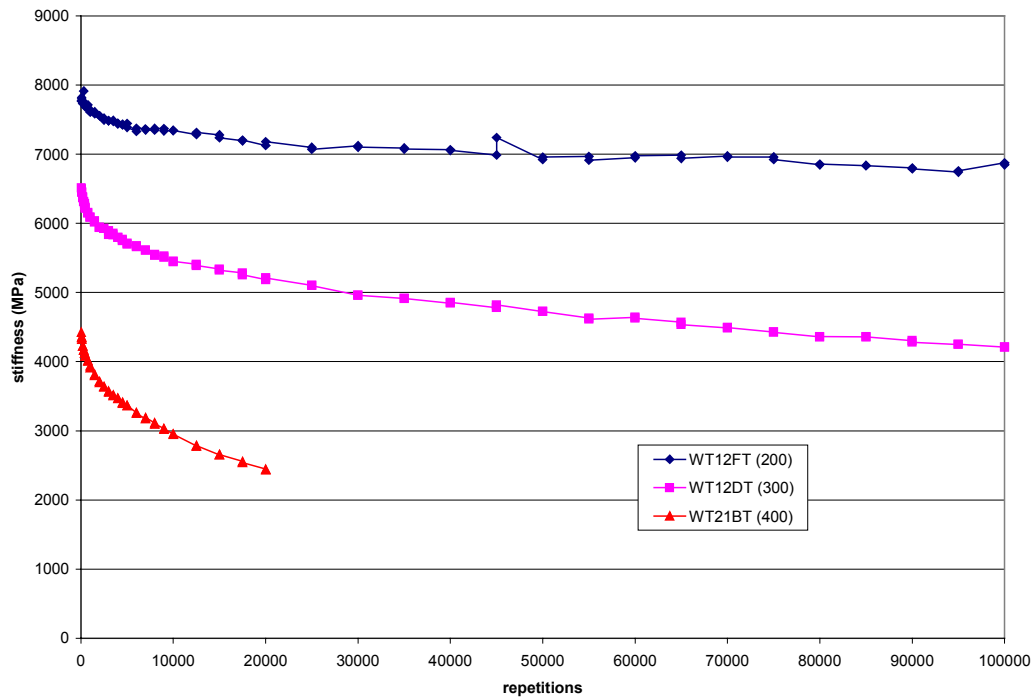

Figure 4.36. Stiffness deterioration curves at various strains in terms of stiffness versus repetition.

Also, it should be noted that, for a simple fatigue test, the test beam is subjected to a constant strain level throughout the test. If the material experiences various strain levels rather than a constant strain level during its service life, how then will the fatigue damage process behave? To answer this question, a hypothesis is postulated and several sequential fatigue tests are performed to confirm the hypothesis. The hypothesis put forth is:

Hypothesis 1: *If the tensile strain level changes from one level to the other at a given instant (repetition), whereas all other variables remain unchanged, the stiffness deterioration rate will follow the rate of the new level, starting immediately at that specific instant (repetition).*

4.10.3 Test Results and Analysis

According to the test plan of Chapter 3, two 200-400-200 tests, two 400-200-400 tests, one 400-200 test, and one 200-400 test were conducted at a temperature of 20°C, with a loading frequency of 10 Hz, and with a conventional fatigue test setup. Two pre-existing fatigue tests with similar mix properties are utilized as comparison tests. The change (in strain) points for the sequential fatigue tests were carefully selected so as to avoid the following dilemma: the lower strain level will introduce more variance but will have a longer time span; whereas the higher strain level will have less variance but a shorter time span. Accordingly, the change points chosen were at 20,000 and 100,000 repetitions for the 200-400-200 and 400-200-400 tests. For the 400-200 and 200-400 tests, the change point was set at 20,000 repetitions. The air-void content and the asphalt content were about the same for all mixes with coarse gradation in this test series (as shown in Table 4.7).

Table 4.7 Mix Properties for the Varied-strain Fatigue Test

Specimen	Strain sequence	Gradation	AC	AV
WTCM57-2CA	200-400-200	CM	5.7	7.1
WTCM57-20CB	200-400-200	CM	5.7	7.6
WTCM57-26CA	400-200-400	CM	5.7	7.3
WTCM57-18CA	400-200-400	CM	5.7	7.3
WTCM57-28CA	400-200	CM	5.7	5.6
WTCM57-28CB	200-400	CM	5.7	5.6
WT23AT	400	CM	5.78	5.5
WT23DT	200	CM	5.78	7.1

Recognizing that common engineering sense dictates that the strain level should not affect the initial stiffness, the stiffness ratios calculated for the sequential varied-strain fatigue test were directly divided by the initial stiffness. Figure 4.37 plots the 200-400-200 test results in terms of SR versus repetition (in logarithmic scale). As seen from the figure, several observations can be made:

1. At the beginning, i.e., the 200 microstrain phase, the stiffness deterioration rate is close to the simple 200 microstrain fatigue test.
2. In the second phase, i.e., the 400 microstrain phase, the stiffness deterioration rate sharply drops down and then gradually comes into compliance with the rate of the simple 400 microstrain fatigue test.
3. In the last phase, i.e., back to the 200 microstrain, the stiffness ratio immediately jumps up to approximately 10 percent more than, and then slowly deteriorates until matching up with, the deterioration rate of the simple 200 microstrain fatigue curve.

As seen in Figure 4.38, which plots the test results of a 400-200-400 sequential fatigue test, the following observations can be made:

1. In the first phase, that of 400 microstrain, the stiffness deterioration rates are following the same rate as that of a simple 400 microstrain fatigue test.

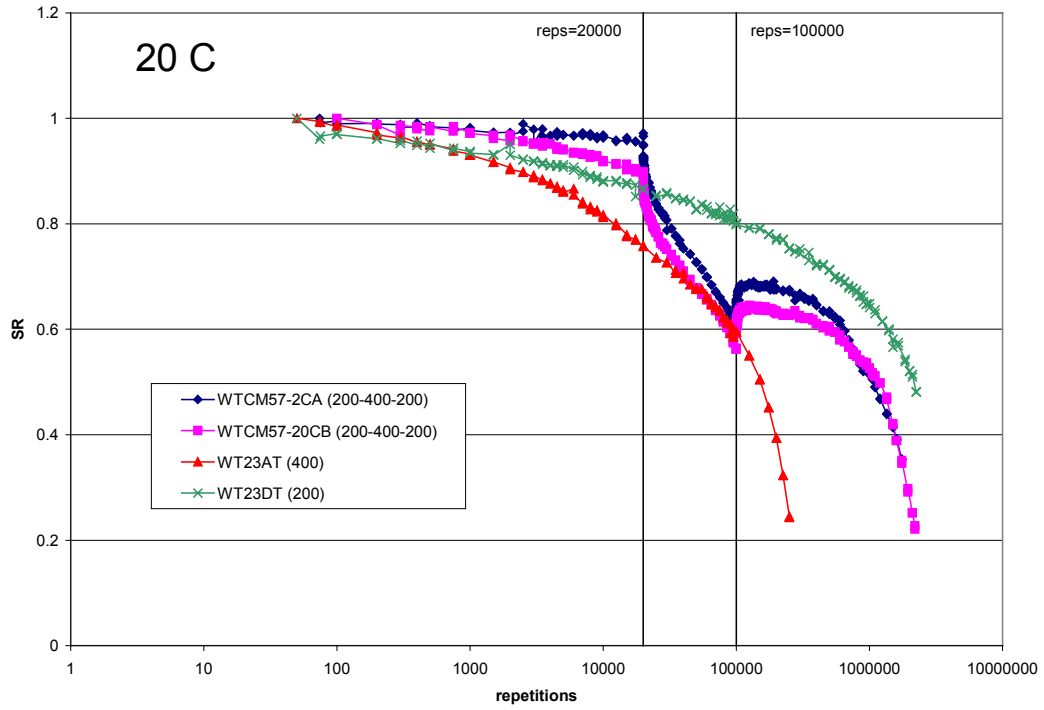

Figure 4.37. A 200-400-200 sequential fatigue test.

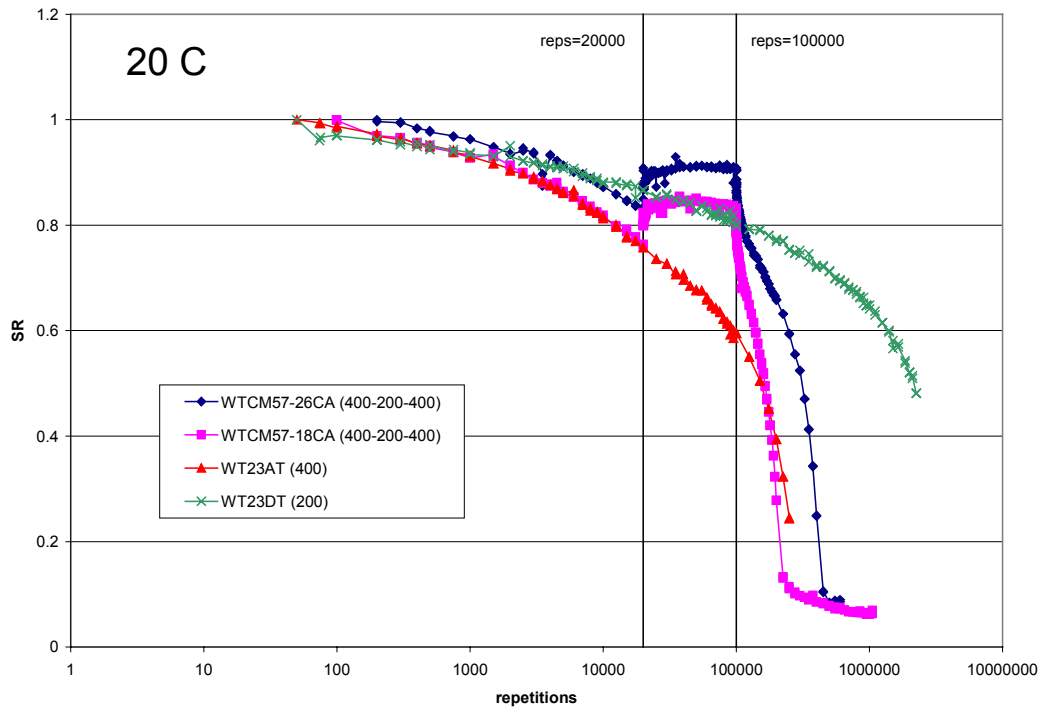

Figure 4.38. A 400-200-400 sequential fatigue test.

2. In the second phase, that of 200 microstrain, the SRs have been raised up about 5 percent and display no obvious stiffness deterioration, in fact, one even shows a slightly upward trend.
3. In the final phase of 400 microstrain, the deterioration rate accelerated and finally complied with the curve of the simple 400 microstrain fatigue test.

For the 400-200 test, shown in Figure 4.39, the stiffness deterioration rate agrees with the simple 400 microstrain fatigue test at the beginning; thereafter, the stiffness ratio raises up about 5-10 percent and then gradually comes to match the deterioration rate of a simple 200 microstrain fatigue test when the strain level switches to 200 microstrains.

In the 200-400 test (Figure 4.40), which switches from a situation of less damage to one of higher damage, the trend of the deterioration curve is in harmony with the simple 200 microstrain test at the beginning, then the stiffness ratio drops down and finally comes to match that of a simple 400 microstrain test.

One thing common to these fatigue tests is that the deterioration rate eventually follows the simple fatigue test curve of the final stage. Initially, the stiffness deterioration rate of each fatigue test complies consistently with the rate of its related simple fatigue test. However, the transition period, here defined as the time needed for the asphalt concrete to adjust itself to a change of strain level, is different for the case of less damage to higher damage (e.g., 200 to 400 microstrains) and in the case of higher damage to less damage (e.g., 400 to 200 microstrains). It shows that the transition period of the case from a higher to a lesser damage level is shorter than that of less to higher. It also illustrates that the stiffness ratio always increases when the strain level switches from a case of high damage to one of less damage.

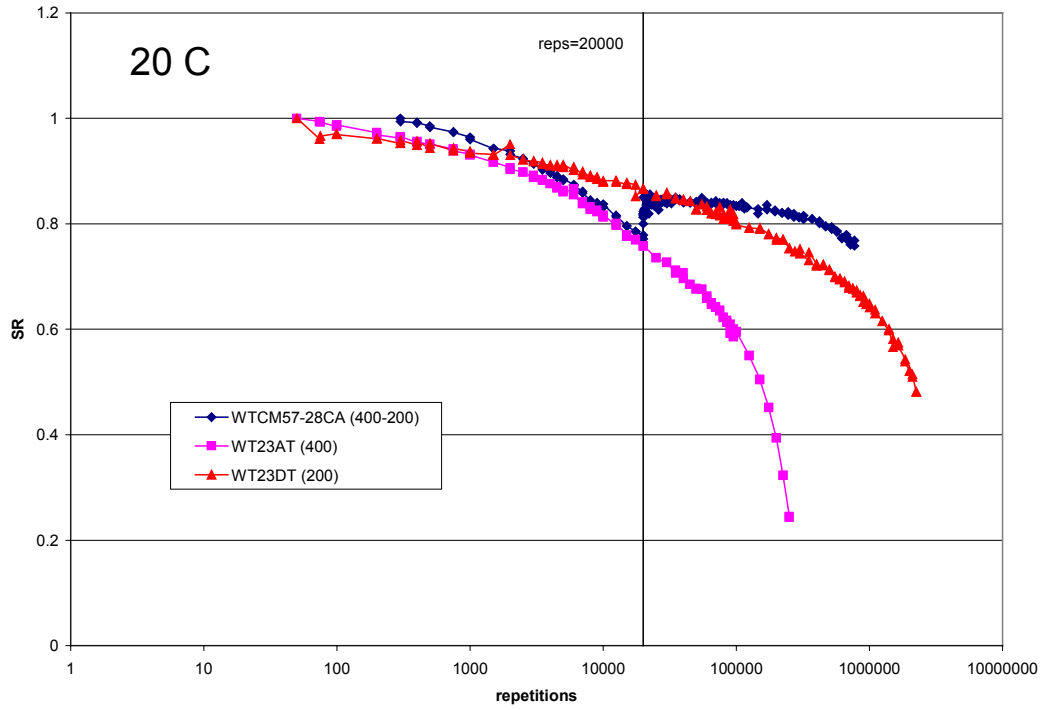

Figure 4.39. A 400-200 sequential fatigue test.

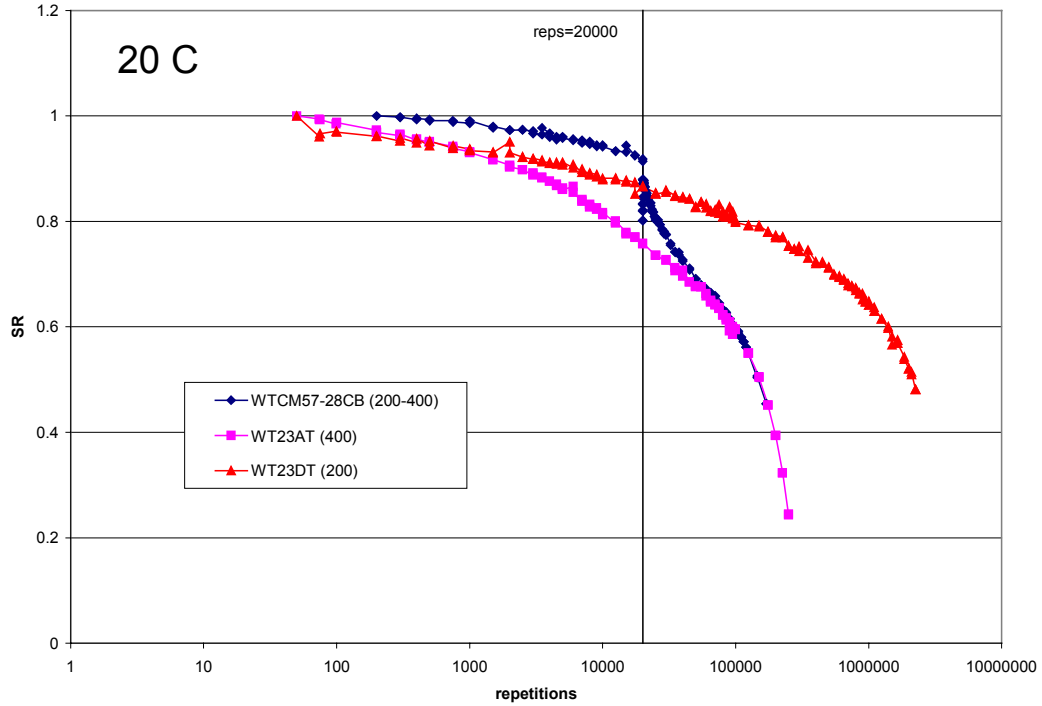

Figure 4.40. A 200-400 sequential fatigue test.

It is this transition period that makes the test results seemingly incompatible with the hypothesis, especially the part that states, “the stiffness deterioration rate will follow the rate of the new level, starting immediately at that specific instant (repetition).” Although the test results are “real”, consider an “ideal” material, i.e., a material that can adjust itself in no time when the environmental factor are changed. With this “ideal” material, then, no transition period is called for, and the hypothesis then fits perfectly. Therefore, it is concluded that the hypothesis will hold true if, and only if, the material is an “ideal” material.

Figure 4.41 present the test results of all the fatigue tests. The same information is also illustrated in Figure 4.42 but in terms of stiffness versus repetition. In Figure 4.42, the values of initial stiffness of the fatigue tests are scattered from 6,000 MPa to 9,000 MPa. One of the advantages to utilizing the stiffness ratio instead of stiffness is to eliminate the variation of the data as seen in this figure.

An alternative way to verify the fatigue damage process caused by the strain effect among various sequential fatigue tests is to plot the cumulative dissipated energy versus repetitions as demonstrated in Figure 4.43. Several findings utilizing the dissipated energy to identify the strain pattern can be summarized as follows:

1. The rates of change of cumulative dissipated energy are the same for both the 200 and 400 microstrain levels, as shown by two parallel straight lines on the logarithmic scale of repetition. At a given repetition, the 400 microstrain fatigue test possesses higher cumulative dissipated energy than that of a 200 microstrain fatigue test.
2. The rate of change of cumulative dissipated energy initially follows a straight line (on a logarithmic scale of repetition) and eventually becomes flat. It is believed that observed macrocracks start to propagate when the rate flattens.

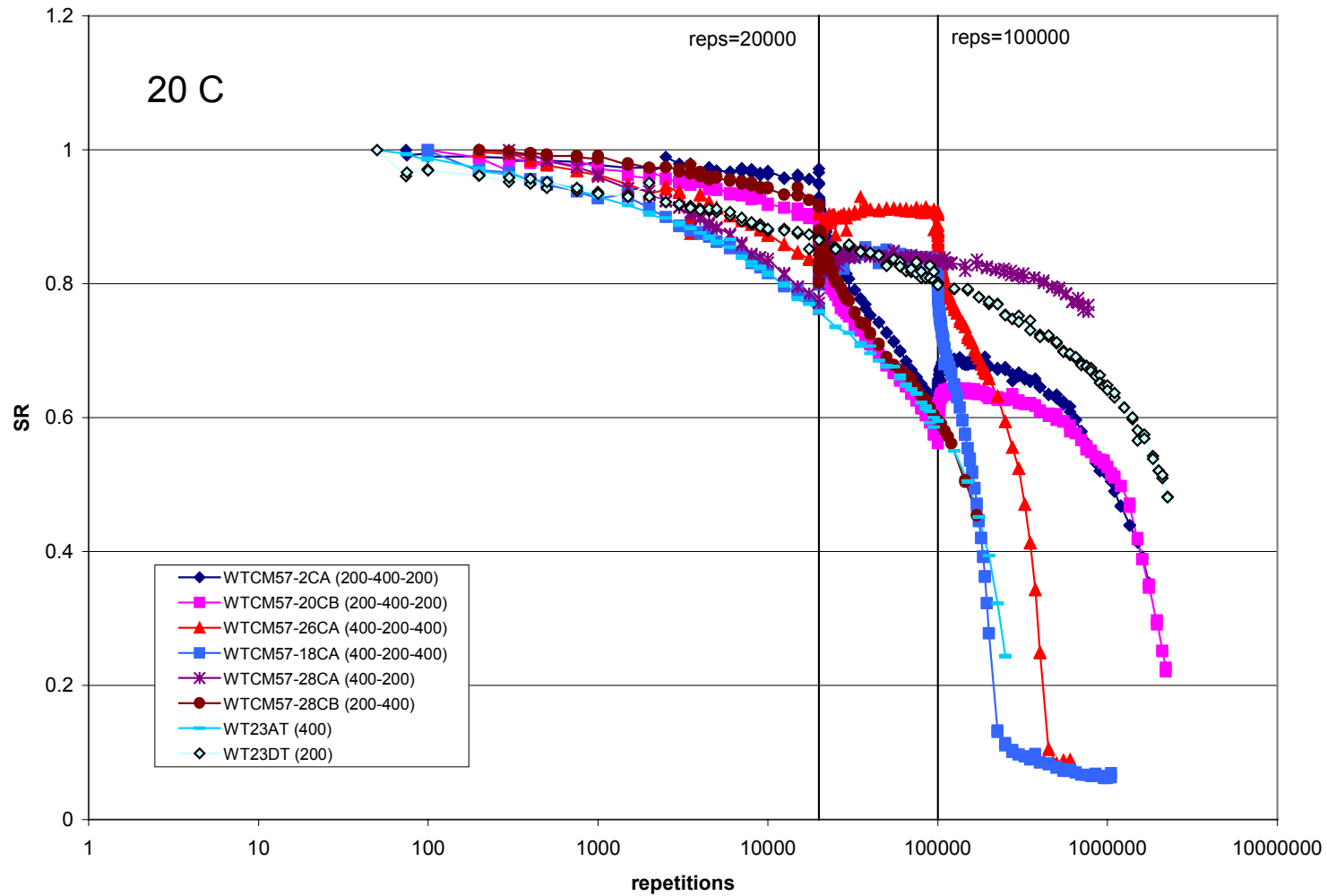

Figure 4.41. A summary of varied-strain fatigue tests in terms of SR versus repetition.

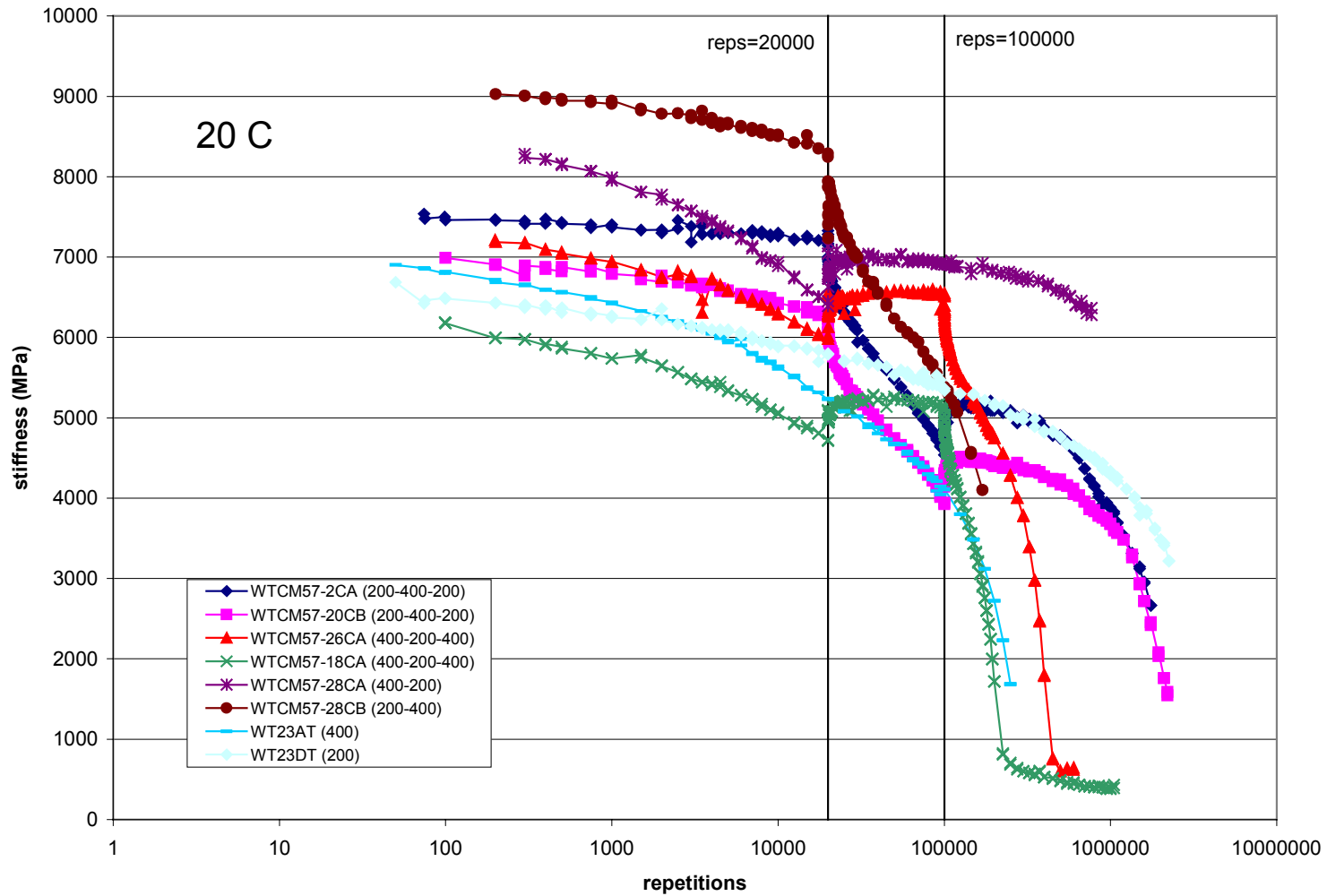

Figure 4.42. A summary of varied-strain fatigue tests in terms of stiffness versus repetition.

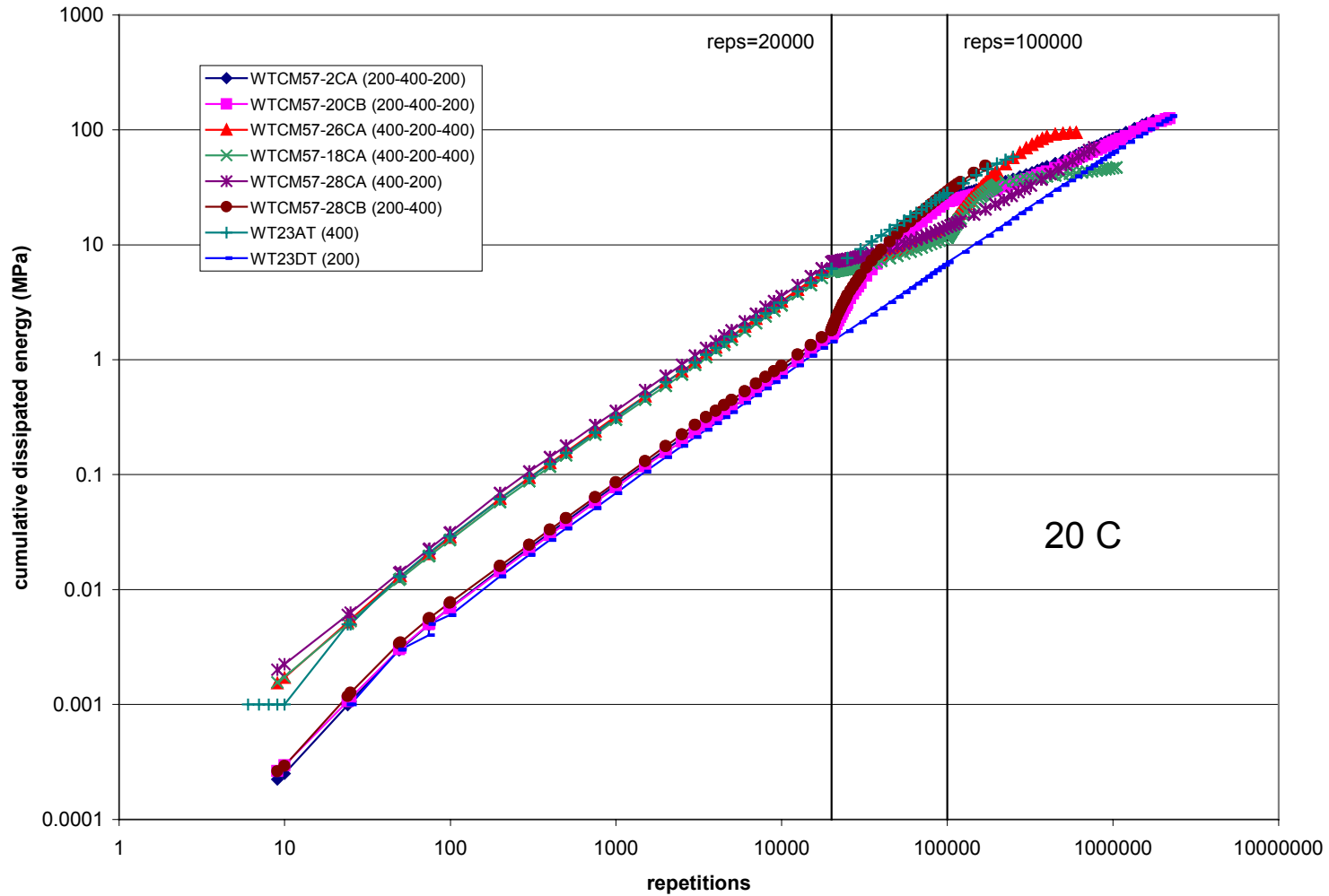

Figure 4.43. Cumulative dissipated energy plot for varied-strain fatigue tests.

3. When the strain level switches from low to high, the rate starts to increase and then slow down until it matches the rate of the higher level; conversely, when switching from high to low the rate starts to decrease until slowly complying with the rate of the lower level.
4. The variation of the cumulative dissipated energy curve is relatively negligible as compared to that of the stiffness ratio plot. Although the energy approach demonstrates its advantages over the stiffness ratio approach, it is still hard to replace the stiffness ratio with the cumulative dissipated energy because it is hard to measure and define the magnitude of energy in real pavement.

4.11 Varied-Temperature Fatigue Test

4.11.1 The Temperature Effect on Weibull Curves

In the temperature susceptibility fatigue tests shown in Table 4.2, it is clear that the temperature effect significantly affects not only the initial stiffness but also the slopes and intercepts of the Weibull curves. Several fatigue tests of coarse mixes were extracted from the temperature susceptibility fatigue tests and the high temperature fatigue tests and were plotted together in terms of $\ln(-\ln(SR))$ versus $\ln(\ln(n))$ as shown in Figure 4.44. Figures 4.45 and 4.46 also present the same information but with different axes. The slopes of the Weibull curves are obviously affected by the temperature. The 5°C curve has a sharper inclination than do other temperatures, the 40°C curve has the flattest slope, and the test at 40°C seems to introduce much temperature variation. The pattern of gradually changed slopes is quite clear among the 5°C, 20°C, and 30°C tests; the curve of 40°C, however, does not fit with this pattern. This figure also

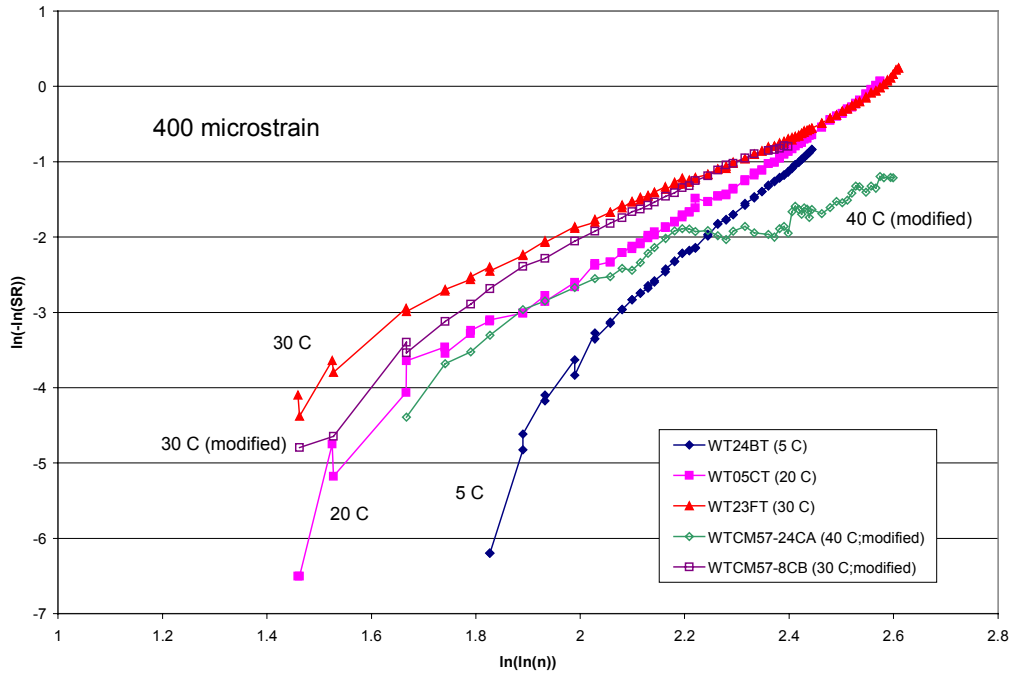

Figure 4.44. Weibull curves at various temperatures.

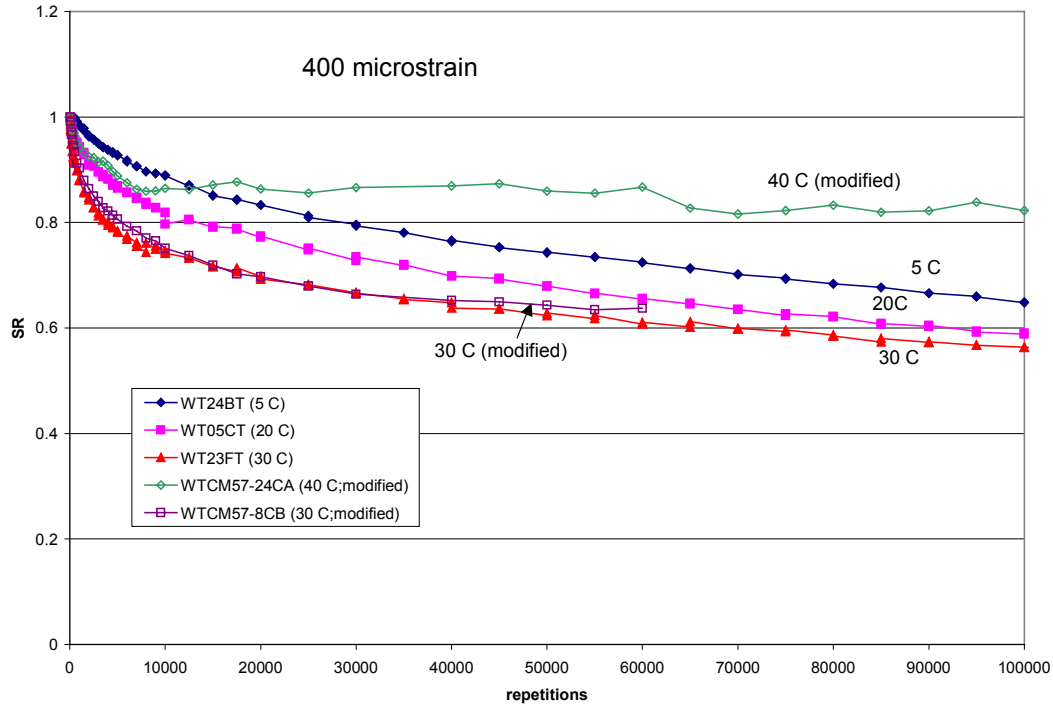

Figure 4.45. Stiffness deterioration curves at various temperatures in terms of SR versus repetition.

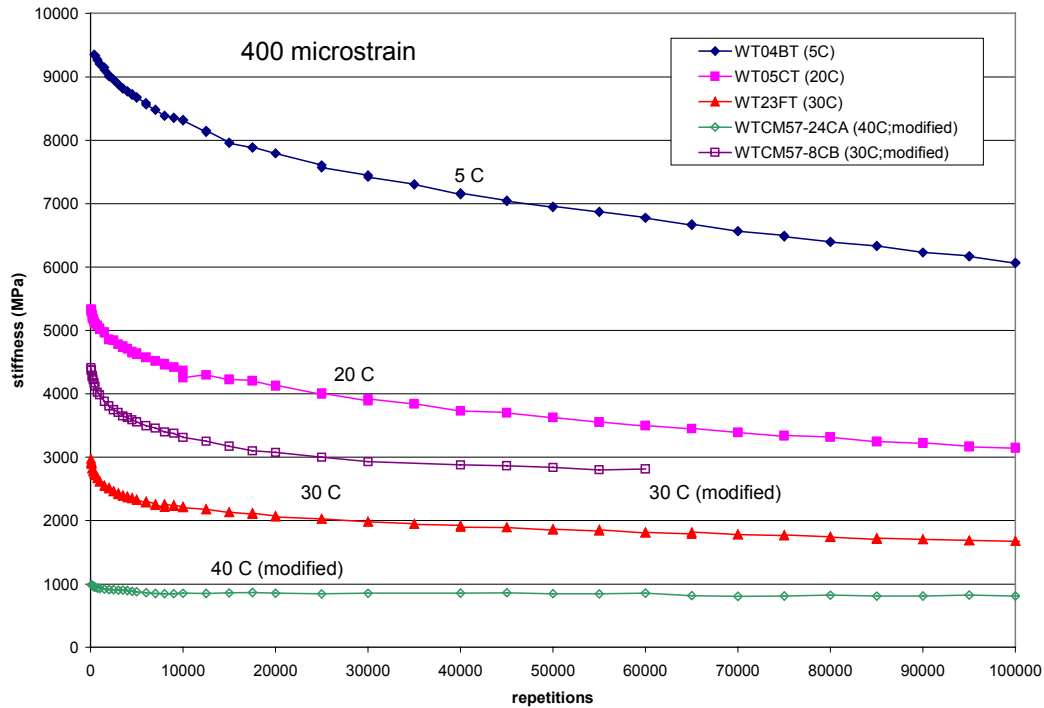

Figure 4.46. Stiffness deterioration curves at various temperatures in terms of stiffness versus repetition.

shows that the fatigue test results from the modified fatigue test setup are very consistent with the fatigue test results obtained from the conventional fatigue test setup at 30°C.

4.11.2 A Hypothesis of Temperature-Caused Fatigue Damage

The effect of temperature on the fatigue damage process is evident provided that the asphalt concrete encounters the same temperature throughout its life. This is definitely too simple to reflect the real world; asphalt pavement in the field is subjected to daily and seasonal variations of temperature, a far cry from a lifetime exposure to a constant temperature.

Subsequently, the question raised is how the fatigue damage process behaves when subjected to temperature variation. A hypothesis similar to the hypothesis of strain-caused fatigue damage is

proposed and several varied-temperature sequential fatigue tests will be conducted to verify this hypothesis. The hypothesis put forth here is:

Hypothesis 2: *If the temperature changes from one level to the other at a given instant (repetition), whereas all other variables remain unchanged, the stiffness deterioration rate will follow the rate of the new level, starting immediately at that specific instant (repetition).*

In other words, when the temperature varies from one level to a higher level, the stiffness deterioration will continue as though it has been deteriorating at the higher temperature level; conversely, when the temperature changes from one level to a lower level, the stiffness deterioration will continue as though it has been deteriorating at the lower temperature level.

4.11.3 Test Results and Analysis

According to the test plan of Chapter 3, this hypothesis will be confirmed using four varied-temperature fatigue tests, consisting of two 30-20-30 tests, two 20-30-20 tests, one 30-20 test, and one 20-30 test. All tests were conducted at the 400 microstrain level with a loading frequency of 10 Hz and a conventional fatigue test setup. Two pre-existing fatigue tests with similar mix properties were utilized as comparison tests. The change points for the sequential varied-temperature fatigue tests were carefully selected so as to allow enough time for the temperature inside the asphalt concrete beam to stabilize when the temperature has been changed from one level to another level. In addition, another concern was that the fatigue life should cover the phase change of temperature. Figure 4.47 demonstrates the time needed for an asphalt concrete beam to stabilize its temperature from 30°C to 20°C and vice versa. As seen in the

figure, the time needed to stabilize the temperature is about one and half hours either from 30°C to 20°C or from 20°C to 30°C. To obtain the data shown in Figure 4.47, a hole, roughly the same diameter as the temperature sensor, was drilled in one end of the beam to a depth of about 10 cm, the sensor plug was inserted, the temperature switched, and the temperature change inside the beam was recorded. Accordingly, the change (in temperature) points chosen were at 3,000 and 57,000 repetitions for the 30-20-30 and 20-30-20 tests. For the 30-20 and 20-30 tests, the change point was set at 3,000 repetitions. The major mix properties of these specimens are listed in Table 4.8.

As stated previously, the initial stiffness is profoundly affected by temperature variation. The stiffness at 30°C is less than the stiffness at 20°C. Henceforth, if presented in terms of SR, the stiffness needs to be divided by appropriate initial stiffness at various temperatures. In doing so, a regression equation of initial stiffness and a temperature variation curve of the beam are necessary to interpolate the initial stiffness in between 20°C and 30°C. No two beams are given the same initial stiffness, even those with the same mix. Thus, for a 20-30-20 and a 30-20-30, or a 30-20 and a 20-30 tests, the awkward situation encountered is that the initial stiffness might easily be obtained at the first temperature of each test but the initial stiffness will be unobtainable at the second temperature. Therefore, utilizing the original stiffness to characterize the property of the fatigue damage process due to the temperature variation is recommended.

Figure 4.48 shows the test results of a 20-30-20 test and two simple fatigue tests at 20°C and 30°C respectively. The two 20-30-20 test curves agree exactly, except in the tail part. Before repetition 3,000, the deterioration rates of the two 20-30-20 tests and a simple fatigue test

at 20°C test are almost identical. Notice that, after repetition 111,000, the stiffness deterioration

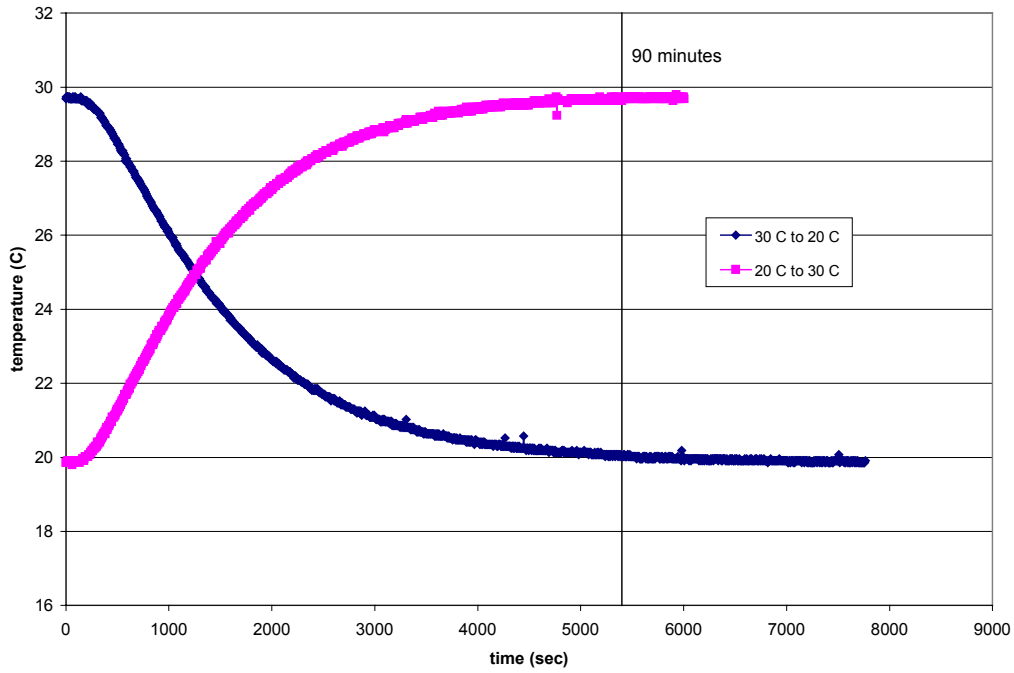

Figure 4.47. Time needed for internal temperature stabilization of a beam.

Table 4.8 Mix Properties for the Varied-temperature Fatigue Test

Specimen	Strain sequence	Gradation	AC	AV
WTCM57-4CB	20-30-20	CM	5.7	7.3
WTCM57-6CB	20-30-20	CM	5.7	7.0
WTCM57-6CA	30-20-30	CM	5.7	7.5
WTCM57-16CB	30-20-30	CM	5.7	7.6
WTCM57-24CB	30-20	CM	5.7	6.8
WTCM57-10CA	20-30	CM	5.7	7.6
WT23FT	30	CM	5.78	6.0
WT23AT	20	CM	5.78	5.5

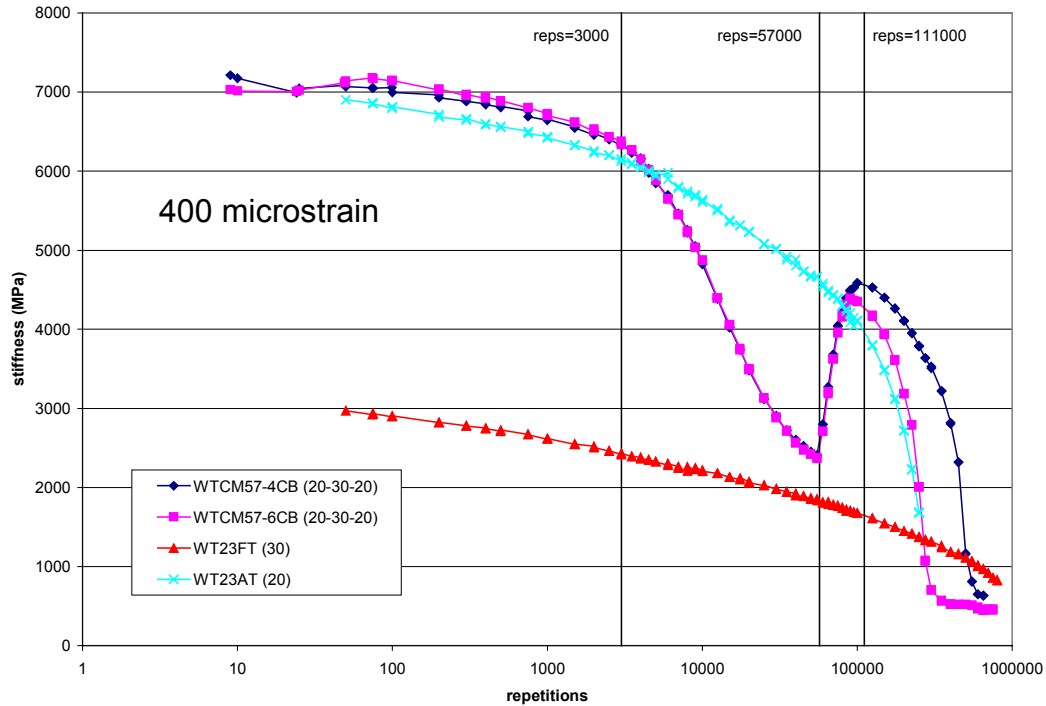

Figure 4.48. A 20-30-20 sequential fatigue test.

rates of the two 20-30-20 tests are again in compliance with the rate of a simple fatigue test at 20°C.

Two 30-20-30 tests as well as one simple fatigue test at 20°C and one at 30°C are presented in Figure 4.49. The two 30-20-30 test curves resemble the dorsal fin of a killer whale in shape. The stiffness varies proportionally with the temperature. The stiffness stabilizes and then starts to deteriorate once a steady temperature is reached. As seen in the figure, when the temperature raises back up to 30°C, the deterioration rates of these two tests are again compatible with that of the simple fatigue test at 30°C.

Figures 4.50 and 4.51 give an even clearer picture of how the stiffness deteriorates while the temperature changes. As seen in these two figures, the deterioration rate immediately

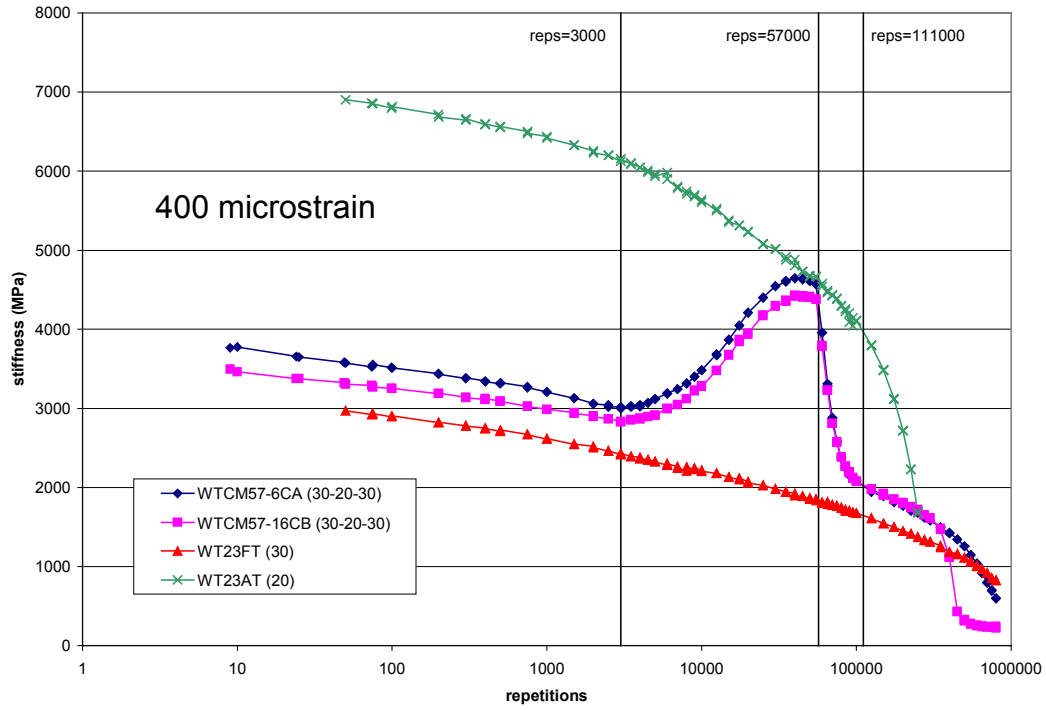

Figure 4.49. A 30-20-30 sequential fatigue test.

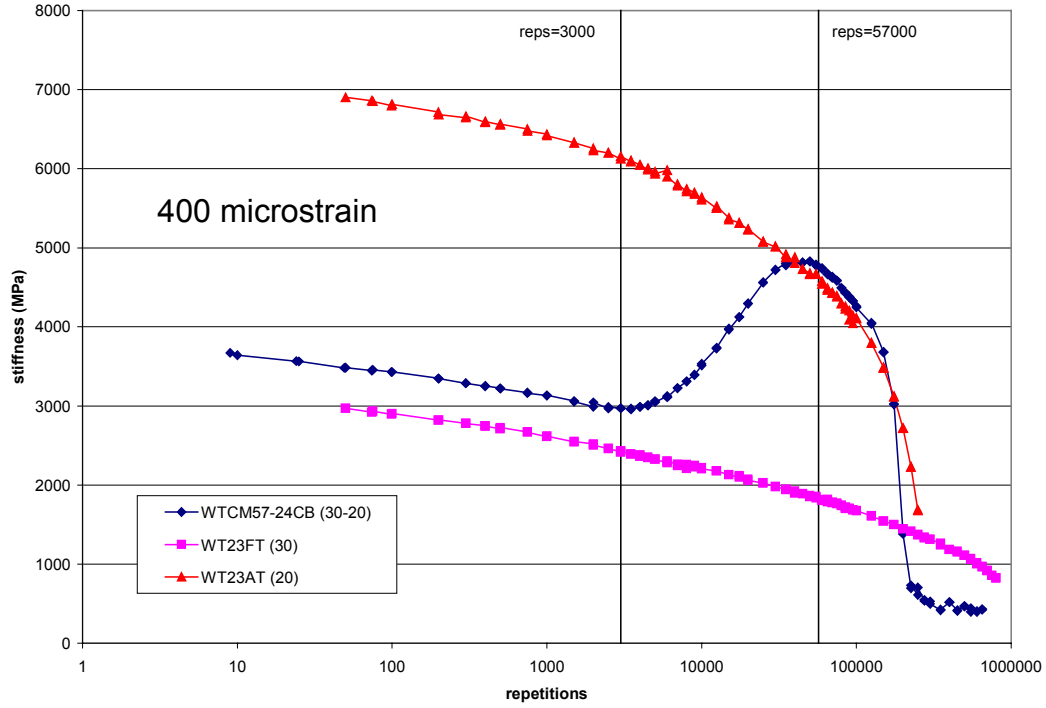

Figure 4.50. A 30-20 sequential fatigue test.

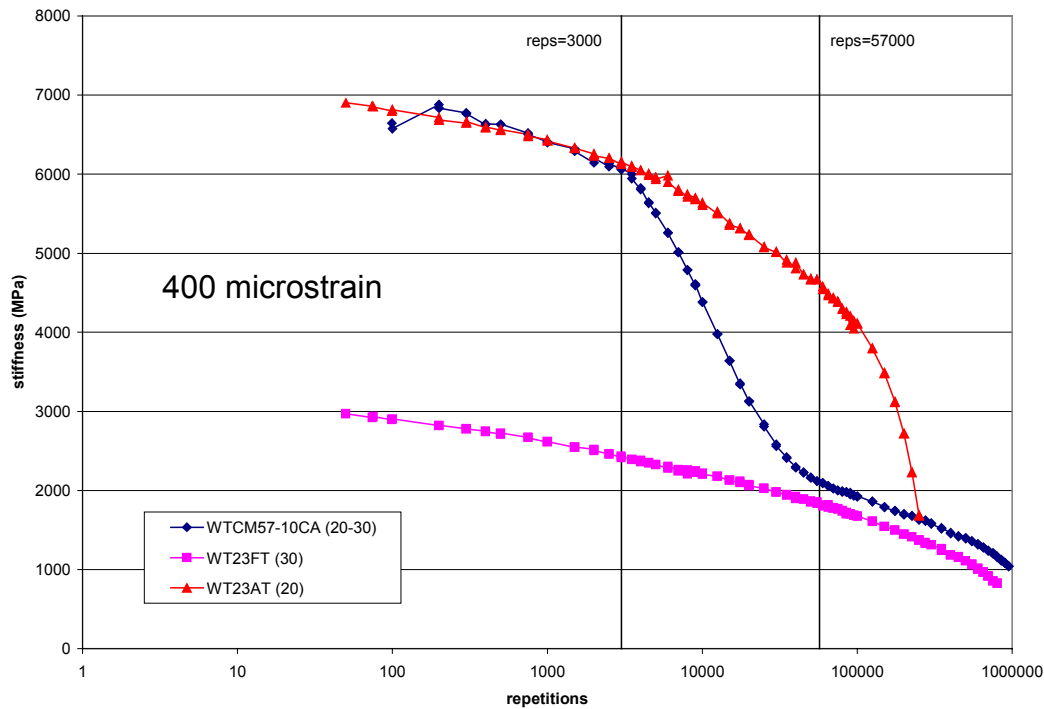

Figure 4.51. A 20-30 sequential fatigue test.

follows the single temperature rate at the time when the temperature of the beam stabilizes at a new level.

Figure 4.52 summarizes all the temperature-varied fatigue tests to show the corresponding relationships among various tests.

For the controlled-strain fatigue tests with the same test strain, the temperature effect on the cumulative dissipated energy is difficult to perceive, as is illustrated in Figure 4.53. Hence, it is not possible to identify the temperature effect on the fatigue damage process utilizing only the cumulative dissipated energy as a tool. Practically, either the stiffness or the SR is a more accessible and useful tool in identifying not only the strain effect but also the temperature effect.

As in the discussion of the varied-strain fatigue test, refer again to an “ideal” material, a material that can adjust itself in no time when the environmental factors are changed. Therefore,

the transition period will approach zero if the material is an ideal material. It is also concluded that the hypothesis holds true if, and only if, the material is an “ideal” material. The hypothesis of temperature change as contributing to the fatigue damage process is hereby verified without any further proof.

Given that the tests conducted in this study are not enough to include all the possible covariates, the test results simply reveal possible trends that provide clues as to what asphalt concrete encounters during a temperature change.

4.12 Findings and Discussions

4.12.1 Findings in Fatigue Test Results and Regression Analysis

In summarizing the fatigue test results, it was found that the temperature effect on the stiffness and the strain effect on the fatigue life are two effects that are more prominent than those caused by the other material variables. The test results also show that the effect of various gradation types on either the stiffness or the fatigue life is evident. In general, the coarse gradation has better fatigue performance than the fine gradation. However, this finding is at odds with the condition survey data of WesTrack. It might be conjectured that the conventional fatigue analysis, which is based on the assumption of crack initiation at 50 percent stiffness reduction, cannot describe the crack propagation phenomenon as it occurs in cold weather.

Upon inspection of the regression results of this study, it was also found that determining the effect of temperature on stiffness and the strain effect on fatigue life provides two primary means of assessing the stiffness and fatigue performance, respectively, of an asphalt concrete material. In this study, no matter what types of fatigue tests were conducted, or gradation types tested, it is clear that this is true.

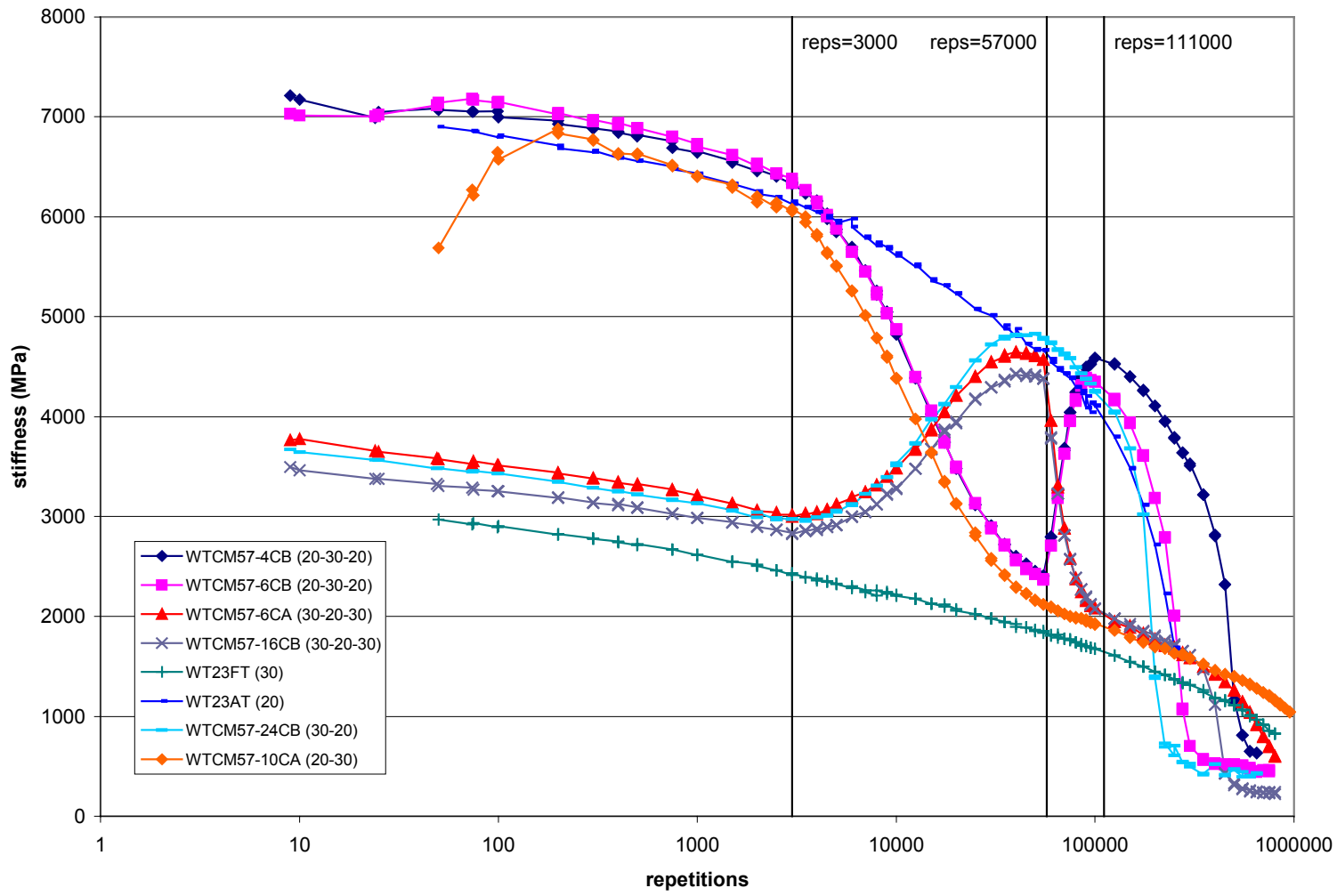

Figure 4.52. A summary of varied-temperature fatigue tests in terms of stiffness versus repetition.

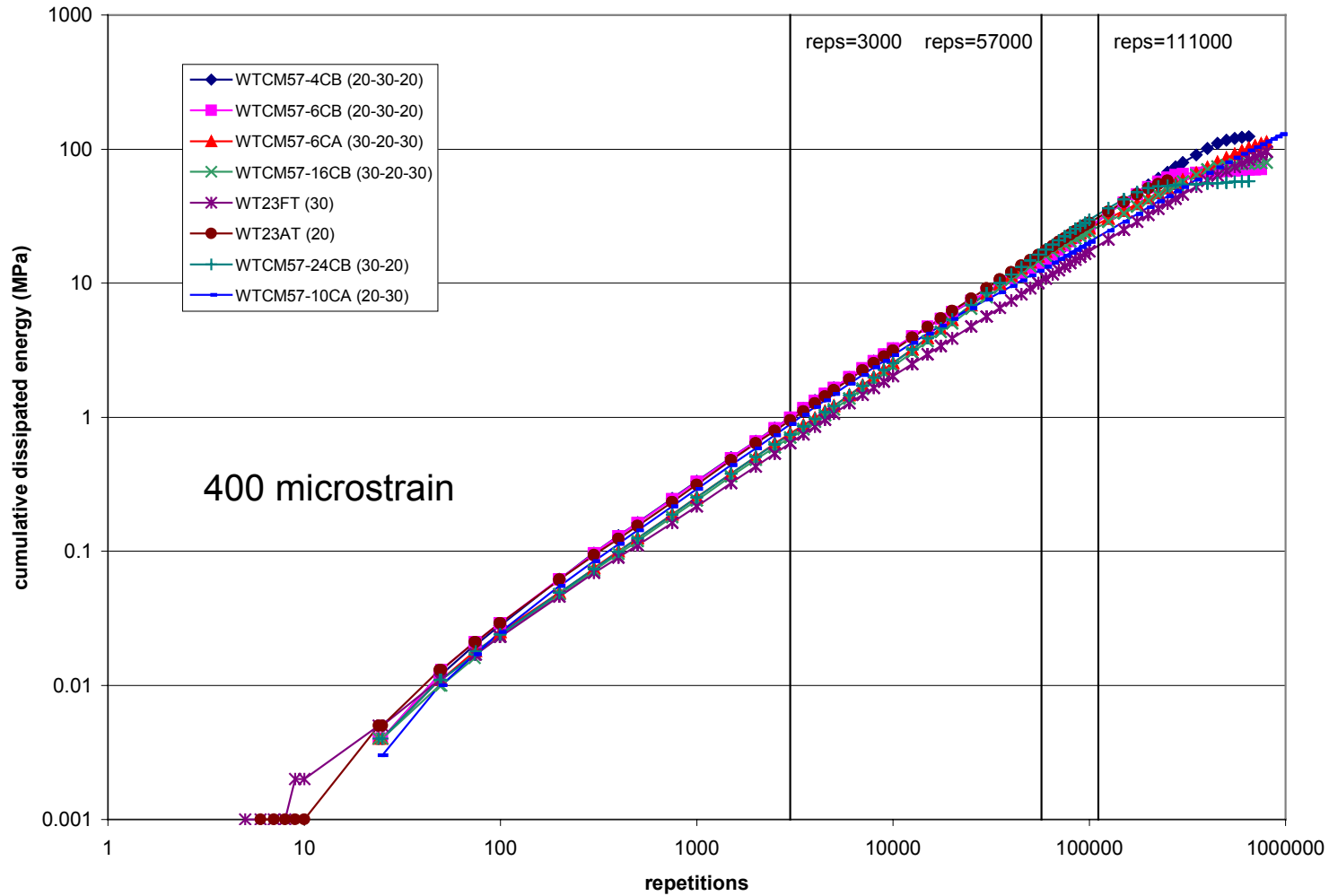

Figure 4.53. Cumulative dissipated energy plot for varied-temperature fatigue tests.

The conventional regression analysis for fatigue life cannot fully describe the fatigue damage process because instead of taking into account all the points that in combination make up the fatigue damage process, it only considers the fatigue life at a prescribed failure level, such as a 50 percent stiffness reduction. Thus, a conventional fatigue curve, which is plotted in terms of fatigue life versus strain level, contains the fatigue lives as tested at various strain levels with the same mix. A large body of information pertaining to the fatigue damage process is not collected, thus making it ineffective to apply such an analysis to the prediction of fatigue performance.

4.12.2 Fatigue Life versus Temperature versus Strain Level

Two environmental factors, temperature and strain, greatly affect the magnitude of fatigue life, as seen in Figures 4.54 and 4.55, respectively. The boxplots of Figure 4.54 show a relatively flat and then slightly upward curving relationship of fatigue life versus temperature as the temperature increases. Notice that in Figure 4.54 the data variation for each test temperature was contributed to by all other variables including those of mix properties: *grad*, *ac*, *av*, *rs4s50*, *m200*, *sa*, *vma*, *vfa*, as well as an environmental factor, *stn*. Regardless, these contributors do not obscure the apparent effect of temperature. Likewise, the boxplots of Figure 4.55 demonstrate an even stronger deleterious relationship of fatigue life versus strain level despite the data variation introduced to them by all other variables except the strain level. This signifies not only that temperature and strain level are important factors in determining the magnitude of fatigue life, but also that the strain level is a stronger determinant in regards to fatigue life than is temperature.

In actuality, the strain level and the temperature are two factors that are interrelated in a real pavement. It is known that temperature change causes the stiffness to change and thus

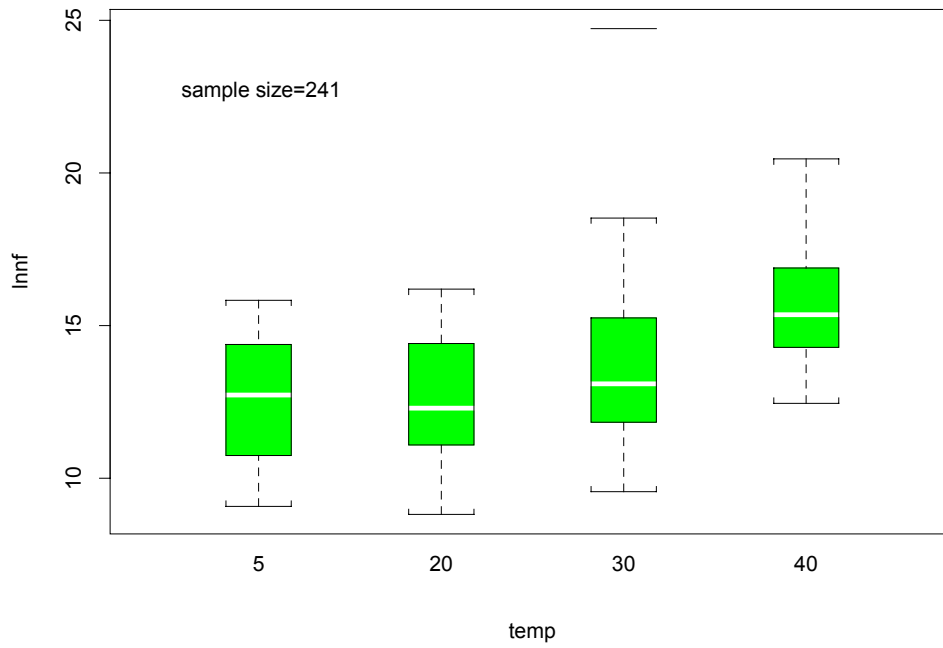

Figure 4.54. Boxplot of fatigue life versus temperature (°C).

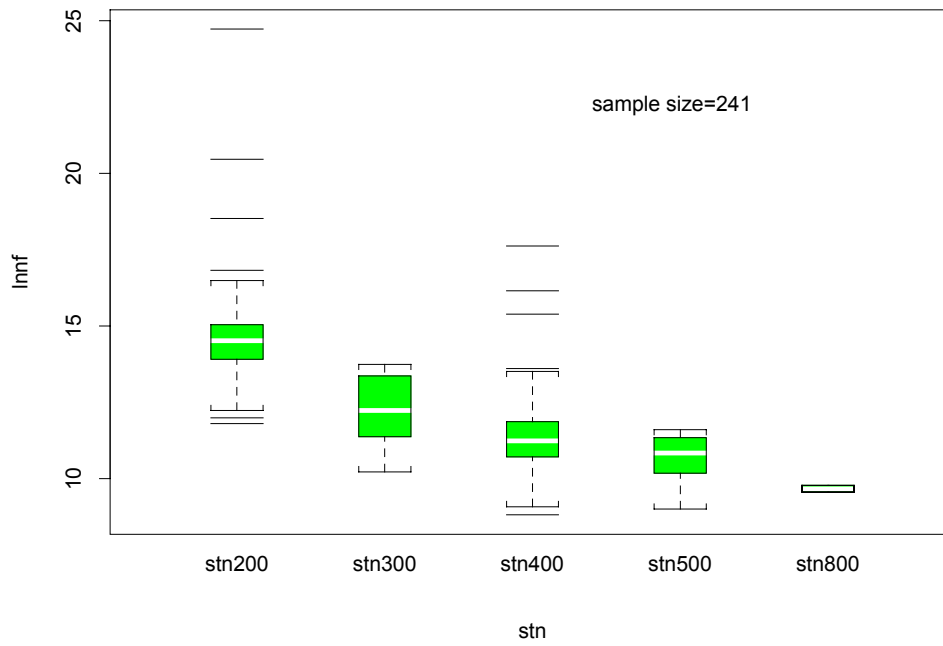

Figure 4.55. Boxplot of fatigue life versus strain.

results in a change of strain levels in a pavement while still subjected to the same traffic load. Insofar as determining what the magnitude of this interaction effect is, further study is warranted.

4.12.3 Crack Initiation and Crack Propagation

It has come to be widely thought that the crack development within an asphalt concrete material should consist of two obvious stages, namely crack initiation and crack propagation. Although a phenomenological-and-statistical definition has been proposed in this study as illustrated in Figure 4.6, a greater understanding of crack initiation and propagation from the mechanistic point of view could be achieved by further exploration with a more refined test setup and a more strict definition.

4.12.4 Weibull Curves at Extreme Test Temperatures

Normally, there are three types of Weibull curves encountered when analyzing fatigue tests: the “reversed-S”, the “falling-C”, and the straight-line type. The reversed-S type of Weibull curves always occurs at low to intermediate temperatures, whereas the falling-C type of Weibull curves occur at high temperatures, as seen in Figure 4.56. The reversed-S shape of a Weibull curve implies that the fatigue failure (or macrocrack) after the initiation and early development stages starts to accelerate and results in a quick drop-down of stiffness ratio, likely as a result of the asphalt-aggregate mix’s tendency to be brittle at low to intermediate temperatures.

As for the falling-C shaped curves, these indicate that the stiffness deterioration is slowing down after passing the crack initiation phase. It is conjectured that the asphalt-aggregate mixes at high temperatures tend to be soft and flexible, possibly relieving some tension on micro-cracks developed in the crack initiation phase, thus slowing the propagation of the crack.

Another observation, discernible in Figure 4.5, is that the conventional failure criterion of fatigue life of a 50 percent stiffness reduction seems to be an appropriate criterion in defining the end of the crack initiation stage.

4.12.5 Coefficients of Weibull Curves

Recall that the coefficients aa , bb , cc , and dd of the Weibull curves were obtained in such a way that, for each fatigue test, only the data located inside the crack initiation stage were chosen. As listed in Tables A.4.1 through A.4.5 for various types of fatigue tests, it shows that the R-squared values of the fitting of a Weibull survivor function are consistently high. Therefore, it is concluded that a Weibull survivor function is well-suited to describe the fatigue damage process in crack initiation. Generally, the fitting in terms of $\ln(-\ln(SR))$ against $\ln(\ln(n))$ has a better fit in the warm-up stage (phase I) as compared with the fitting in terms of $\ln(-\ln(SR))$ against $\ln(n)$.

4.12.6 Problems of the High Temperature Fatigue Test

Two main problems were encountered with the high temperature fatigue testing as conducted in this study. First, by inspecting the data variations of the stiffness deterioration curves, the temperature seems to have not been fully controlled. Secondly, prior to testing it was unclear whether to utilize strain gage control or to adopt LVDT control. It was found that under strain gage control, the asphalt-aggregate mix might relax itself under the repetitive loading. As a result, in order to maintain the desired strain level, the vertical actuator gradually moves up and eventually hits the limit. However, if run under LVDT control, the strain recorded from the strain gage shows that the strain will be gradually decreased as time goes on.

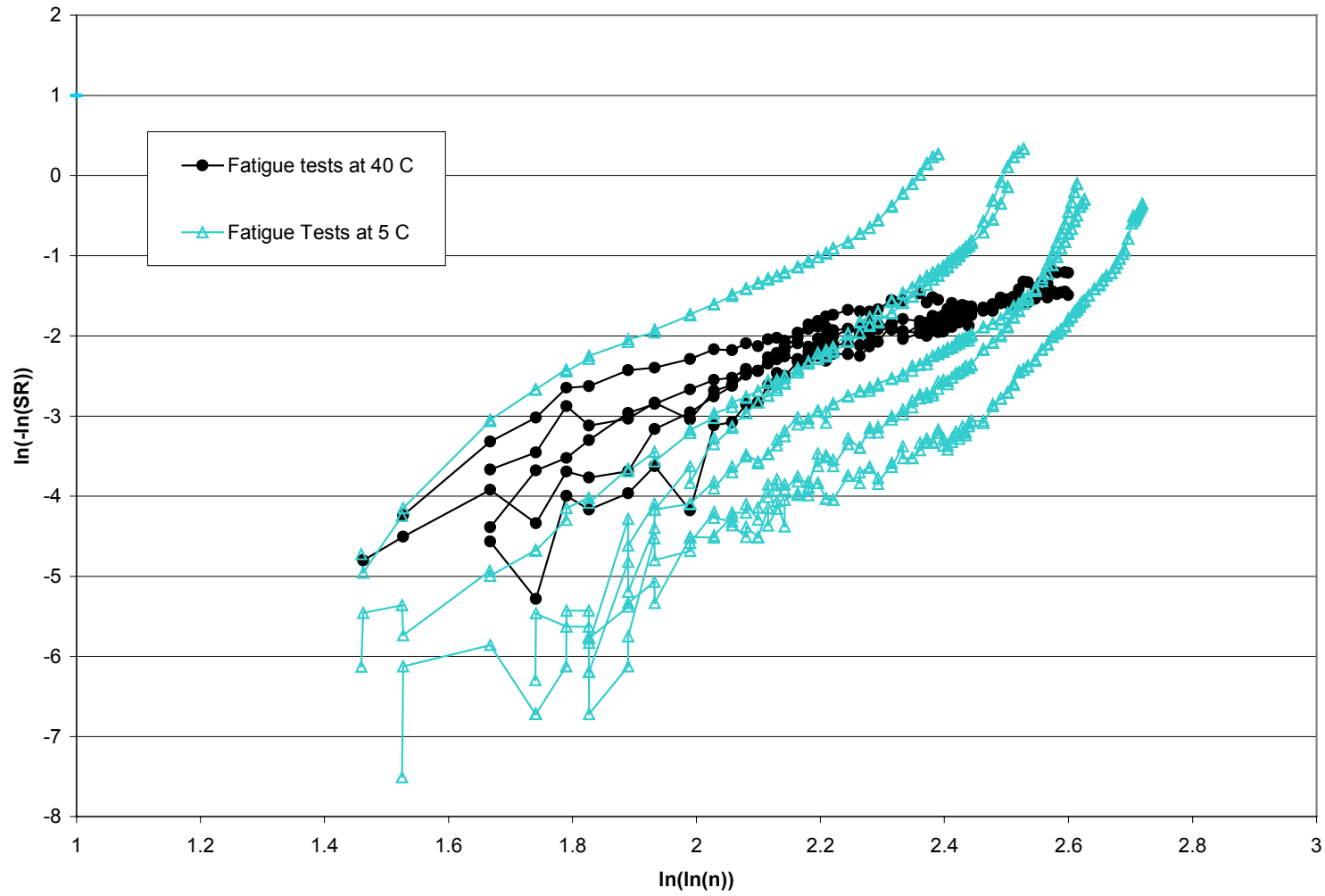

Figure 4.56. Weibull curves at extreme temperatures.

Therefore, test results obtained with either control method are contaminated by a certain degree of error. Further refinement of the test setup and data acquisition system is necessary so as to obtain fully controlled and accurate test results. Additionally, the flexural fatigue beam machine should be equipped with a better environmental control unit for improved control over testing temperatures.

4.12.7 A General Hypothesis of Fatigue Damage

It has been recognized in this data analysis that the tensile strain level and temperature are two extremely important factors affecting the fatigue damage process. However, the interaction effect of temperature and strain level has not been earmarked for inspection in this study. In the verification procedure of Hypotheses 1 and 2, the beams are assumed to have the same (or similar) mix properties and vary only one factor, either temperature or strain level, each time. However, variations of the design material variables or testing conditions makes a noticeable difference on the stiffness deterioration curves even with the same mix and at the same temperature. Thus, it is concluded that another important feature observed in these tests is that each stiffness deterioration curve is unique among its peers within the corresponding testing condition. Accordingly, a hypothesis can be stated as follows:

Hypothesis 3: *For every testing situation containing many variables, there exists one and only one associated stiffness deterioration curve in the SR-N space. If the testing situation changes from one state to the other at a given instant (repetition), the stiffness deterioration rate will follow the rate of the new state, starting immediately at that specific instant (repetition).*

It is expensive in terms of both time and cost to conduct such hypothesis testing, not to mention that there was only a limited amount of material available from the WesTrack project. In the next chapter, it is taken for granted that Hypothesis 3 holds true without any further validation.

4.12.8 Time Hardening and Strain Hardening

Monismith et. al. (1975), utilized “Time Hardening” and “Strain Hardening” procedures to obtain the cumulative permanent strain from the results of simple loading tests. Unfortunately, neither method was very successful in quantitatively describing the experiment data. These two methods are summarized in Figure 1.6.

Revisiting the ideas of the “Time Hardening” and the “Strain Hardening” procedures, Figures 4.57 through Figure 4.60 schematically illustrate the application of these procedures to the fatigue damage process as expressed by stiffness ratio versus time (or repetition). The plot applying the time hardening procedure from low damage level to high damage level is shown in Figure 4.57a. The trajectory of the final stiffness deterioration curve combined from the simple fatigue tests presents an unconventional curve, as seen in Figure 4.57b, one that is not very smooth. As for the damage level being switched from high to low, as viewed in Figure 4.58a, a problem arises in that there is no available curve that can be intersected to continue the procedure. The compound stiffness deterioration curve is shown in Figure 4.58b.

Figures 4.59 and 4.60, respectively, display the application of the strain hardening procedure to the fatigue damage process from low damage level to a high damage level and vice versa.

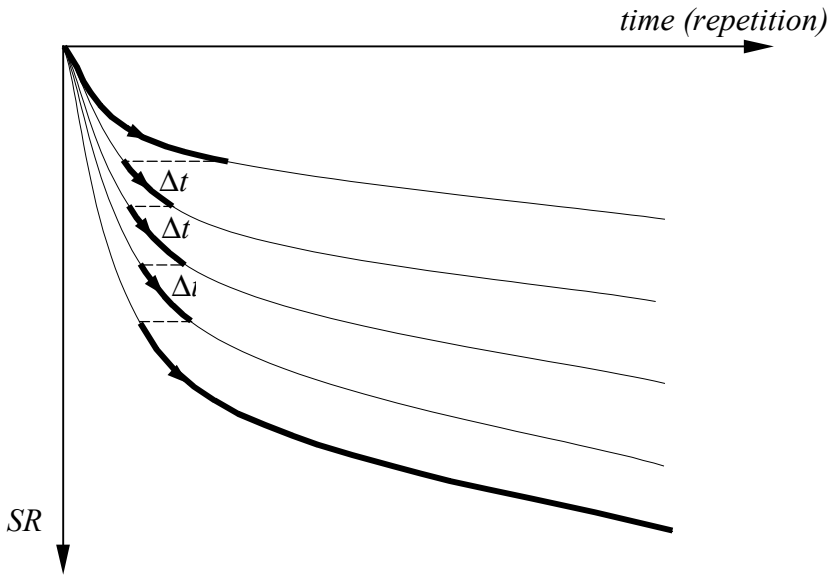

(a) construction procedure

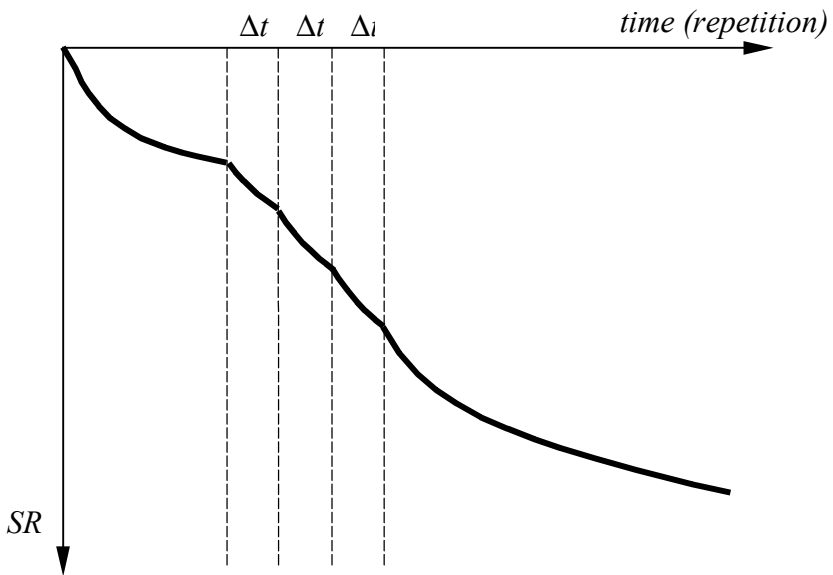

(b) compound stiffness deterioration curve

Figure 4.57. Application of time hardening procedure from a low damage state to a high damage state in terms of SR.

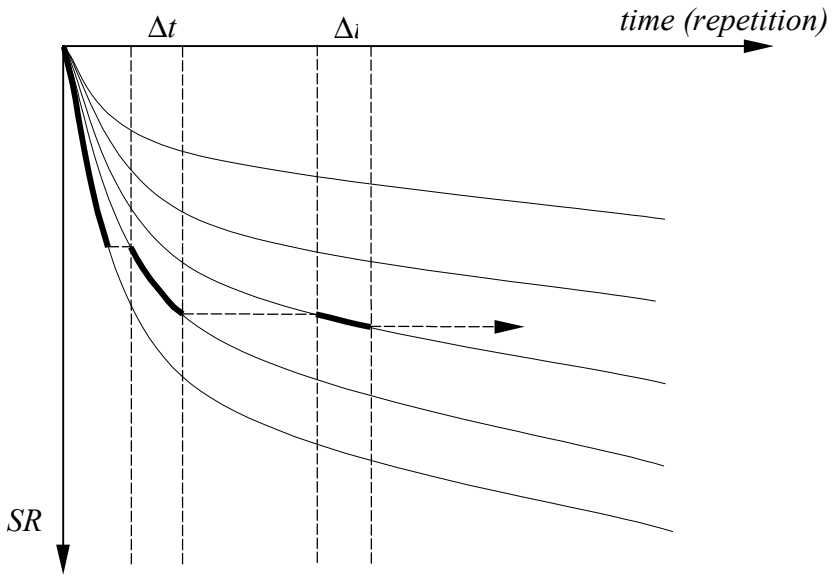

(a) construction procedure

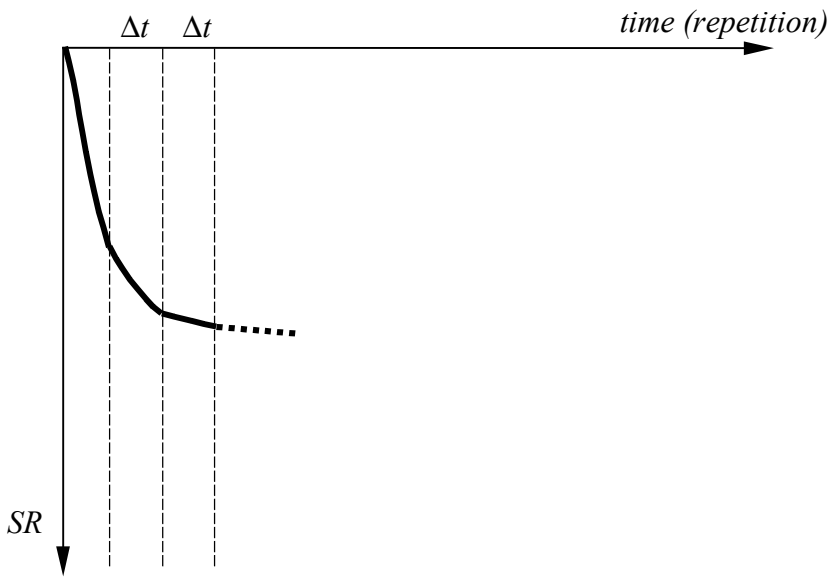

(b) compound stiffness deterioration curve

Figure 4.58. Application of time hardening procedure from a high damage state to a low damage state in terms of SR.

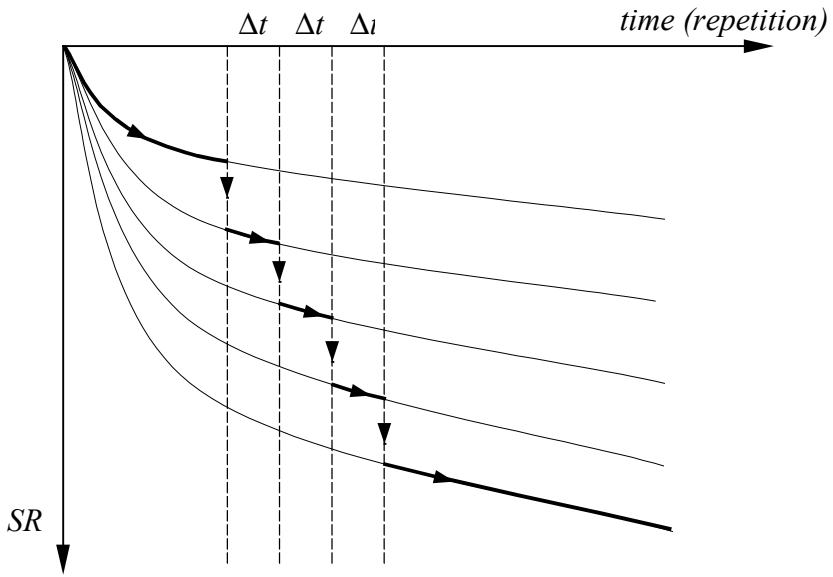

(a) construction procedure

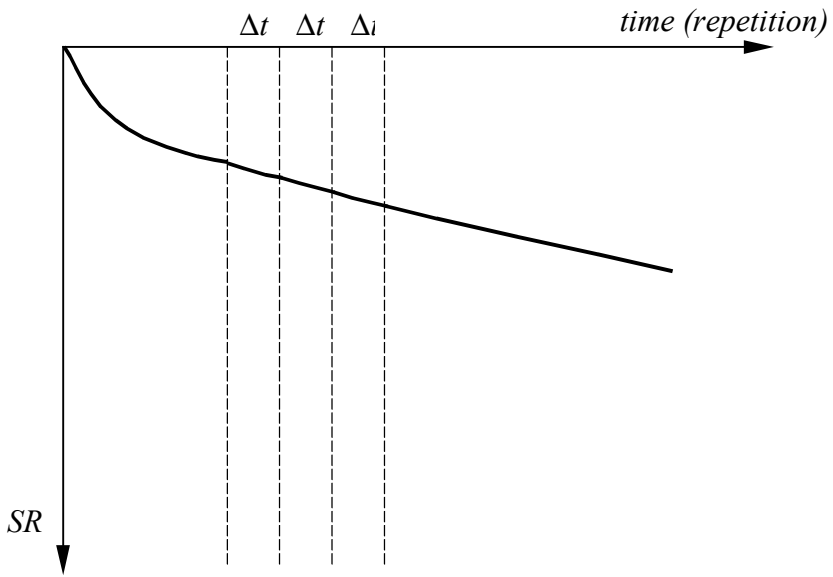

(b) compound stiffness deterioration curve

Figure 4.59. Application of strain hardening procedure from a low damage state to a high damage state in terms of SR.

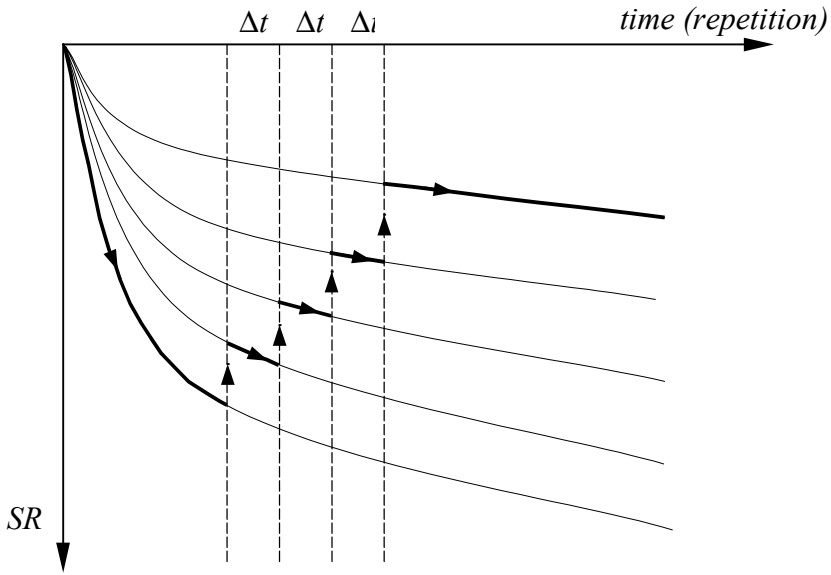

(a) construction procedure

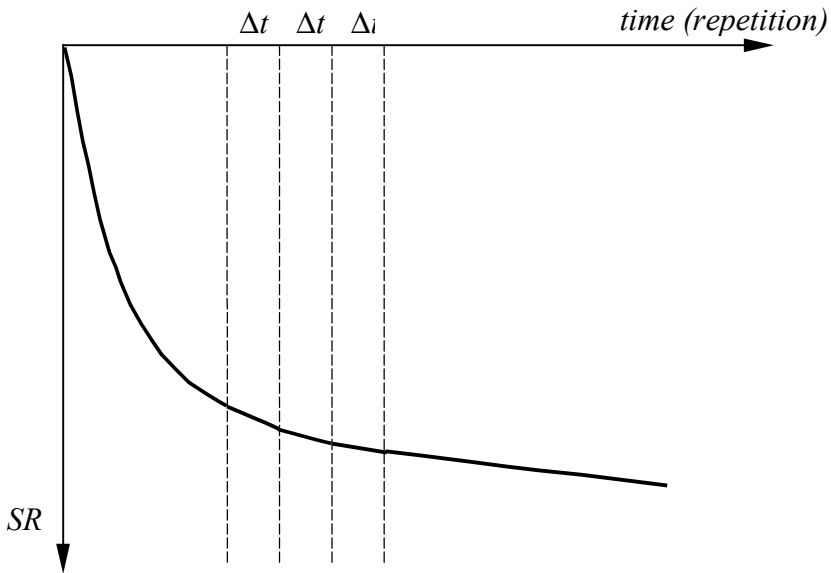

(b) compound stiffness deterioration curve

Figure 4.60. Application of strain hardening procedure from a high damage state to a low damage state in terms of SR .

As verified by the varied-strain and varied-temperature fatigue tests conducted, the appropriately corresponding hypotheses are actually in favor of the strain hardening procedure. Based on the limited number of fatigue tests run, no strong evidence for rejection of the hypotheses was presented. By the same token, there was no proof evident that can strongly support the hypotheses either. Therefore, it is worthwhile to continue the study of the fatigue damage process especially as subjected to varied strains and temperatures.

5.0 WIEBULL THEORY

5.1 Introduction

The applicability of using the Weibull curves to describe the fatigue damage (crack initiation) of asphalt concrete has been successfully demonstrated from the statistical study in Chapter 4. The question that follows will be how to apply the Weibull curves obtained from the laboratory to predict in-situ pavement fatigue performance. Therefore, the goal of this chapter is to present an approach to simulate the in-situ pavement fatigue damage process using the Weibull proportional hazards model (Weibull PH model). The advantage of the Weibull PH model is that it can estimate the baseline function and thus make it possible to estimate the parameters of the model with linear regression.

The fatigue damage process is a stiffness deterioration process caused by the combined effects of material, traffic, and environmental variables. Some of the material variables include air-void content, asphalt content, fines content, aggregate type and gradation, and asphalt type; some traffic variables are traffic load composition, traffic wander, and vehicle speed; and finally, environmental variables mainly include temperature, moisture content, and precipitation. As a result, the fatigue damage process should be a function of all these variables. Stiffness ratios from laboratory fatigue tests is studied herein, to develop a function that reflects the effects of both material and environment variables on the fatigue damage process.

Following the definition given by Bogdanoff (1985), “a stochastic process is a mathematical model of any dynamic process whose evolution with time is governed by probabilistic laws,” it was found that the fatigue failure of a laboratory prepared asphalt concrete beam can be appropriately described by the survivor function with a Weibull density function.

In the following sections, the theoretical background of the Weibull PH model will be briefly described. A set of data from the laboratory temperature sensitivity tests of WesTrack samples is used as an example to illustrate the application of the Weibull PH model. A comparison of predicted regression results and real data is also included. The approach, namely the Weibull dynamic approach, to applying the Weibull PH model to real pavement is also discussed. The use of Miner's Law to explain stiffness ratio change and fatigue life is examined. To bridge the gap caused by the difference of boundary conditions between laboratory test results and in-situ performance, a model, the Weibull accelerated failure time model, is proposed in this chapter. Additionally, an example utilizing the MDD data of CAL/APT Goal 1 Section 503RF is given to verify the feasibility of this failure time model. It should be mentioned that the derivation process of the Weibull theory and the Weibull accelerated failure time model generally follows Collett's famous book on survival analysis (Collett 1994).

5.2 Survival Analysis

Collett offers the following definition of survival analysis: "Survival analysis is the phrase used to describe the analysis of data that correspond to the time from a well-defined time origin until the occurrence of some particular event or end-point." In brief, survival time is the time until an event occurs. In the category of asphalt concrete, the survival time could be defined as the load, stress or strain repetitions, which is the survival time, until the stiffness reaches its 50 percent reduction, which is the event. In the laboratory tests, time and repetition are interchangeable because the loading frequency in this study is fixed at 10 Hz. It should be noted that the survival time is heavily dependent on how the event is defined.

5.2.1 Survivor and Hazard Functions

Two important functions, namely the survivor and hazard functions, are crucial to the survival analysis. The actual survival time of an individual beam, t , can be regarded as the value of a variable T , which is the random variable of survival time. Thus, the different values that T can take have a probability distribution function, called $f(t)$. The distribution function of T is then given by

$$F(t) = P(T < t) = \int_0^t f(u)du$$

The survivor function $S(t)$ is defined as the probability that the survival time is greater than or equal to t , that is,

$$S(t) = P(T \geq t) = 1 - F(t)$$

In this study, the stiffness ratio as a function of repetition (or time) is regarded as the survivor function in survival analysis.

The hazard function is defined as the probability that, for example, the beam will reach its failure criteria, say a stiffness reduction of 50 percent, at time t , conditional on the beam having survived to that time. Thus, for an asphalt concrete beam, the hazard function is the instantaneous damage rate for a beam surviving to time t . Hence,

$$h(t) = \lim_{\delta t \rightarrow 0} \left\{ \frac{P(t \leq T < t + \delta t \mid T \geq t)}{\delta t} \right\}$$

According to the probability theory, for two events A and B with $P(B) \neq 0$, the conditional probability of A given B can be expressed as

$$P(A \mid B) = \frac{P(A \cap B)}{P(B)}$$

Therefore,

$$P(t \leq T < t + \delta t | T \geq t) = \frac{P(t \leq T < t + \delta t)}{P(T \geq t)} = \frac{F(t + \delta t) - F(t)}{S(t)}$$

Hence,

$$h(t) = \lim_{\delta t \rightarrow 0} \left\{ \frac{P(t \leq T < t + \delta t | T \geq t)}{\delta t} \right\} = \lim_{\delta t \rightarrow 0} \left\{ \frac{F(t + \delta t) - F(t)}{\delta t} \cdot \frac{1}{S(t)} \right\} = \frac{F'(t)}{S(t)}$$

The derivative of $F(t)$ with respect to t is $f(t)$. Hence, the hazard function $h(t)$ used in survival analysis is defined as

$$h(t) = \frac{f(t)}{S(t)} = -\frac{d}{dt}(\ln S(t))$$

5.2.2 Fatigue Damage Process and Survivor Function

The fatigue damage process is regarded as a process of stiffness deterioration caused by repetitive loading. Stiffness ratio is a normalized quantity that normalizes the stiffness value relative to its initial stiffness, which is defined as the stiffness at the 50th repetition, for a given testing condition. For incorporation with the survivor probability function, henceforth in this report the fatigue damage process is represented in terms of stiffness ratio, starting from 1.0 and decreasing along with time (repetitions) until, if possible, 0.0.

To begin with, the survival time is defined as the time until an event occurs. So it is important to recognize that the survival time is dependent on how the event is defined. To explain the fatigue damage process utilizing the concept of survival analysis, it is necessary to extend the definition of event.

For example, take a finite set of points from a uniform distribution ranging from 0 to 1 and designate this set as the S set. For the purposes of this example, the S set is the set of stiffness ratios. Then, it is declared that the survival time is the repetition when one of the

elements in S set is reached. The event will be the specified stiffness ratio in S set. If the elements in S set are sorted with a descending order, then the survival times found correspondingly will construct the fatigue damage process (survivor function).

Thus, the interpretation of an SR-N curve (fatigue damage curve or stiffness deterioration curve) is that, for a given SR and its corresponding N, a testing beam has a probability, SR times 100 percent, to survive after the Nth repetition. Alternatively, it can be stated that a testing beam will have SR times 100 percent fatigue life remaining after the Nth repetition.

5.3 Weibull Proportional Hazards Model

5.3.1 Weibull Density Function

The stiffness deterioration in terms of stiffness ratio is utilized as an index of fatigue damage in this Weibull dynamic approach. As presented in Chapter 4, the fit of the stiffness deterioration curve following a two-parameter Weibull function was clearly evident. Figure 5.1 illustrates an example of a fatigue damage process in terms of stiffness ratio versus repetition. As seen in this figure, the stiffness deterioration can be fit very well with the function $\exp(-\lambda t^\gamma)$ with $\lambda = 0.002$ and $\gamma = 0.412$. The corresponding Weibull density function with these two parameters was drawn in a semi-logarithmic plot as visualized in Figure 5.2. Henceforth, it is assumed that the probability density function of T will follow a two-parameter Weibull density function.

The Weibull density function has the following form

$$f(t) = \lambda \gamma t^{\gamma-1} \exp(-\lambda t^\gamma), \quad 0 \leq t \leq \infty$$

where λ is the scale parameter and γ is the shape parameter.

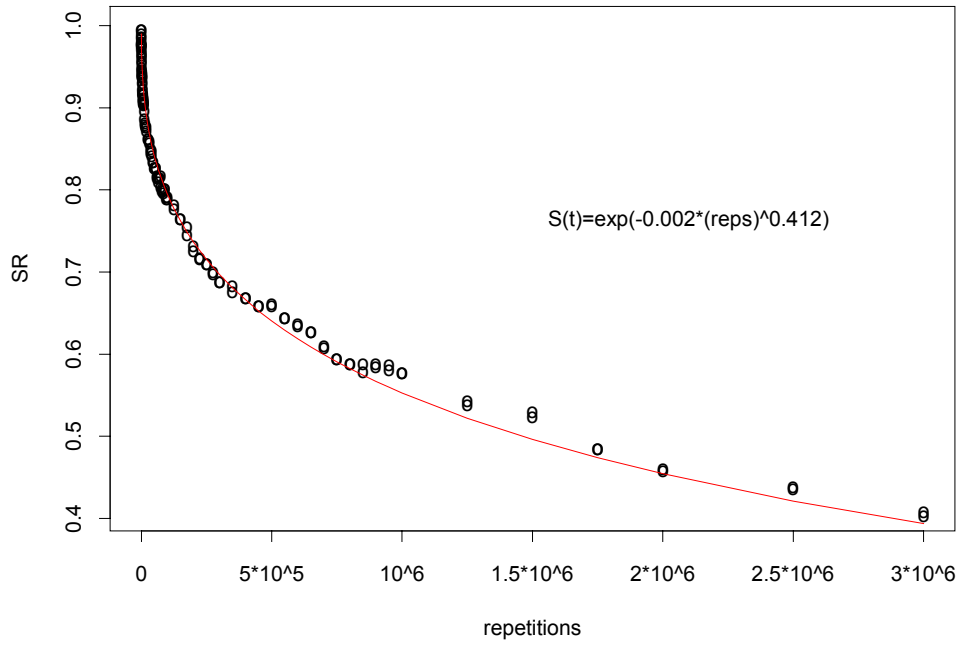

Figure 5.1. Stiffness deterioration curve fitted with a Weibull survivor function with $\lambda = 0.002$ and $\gamma = 0.412$.

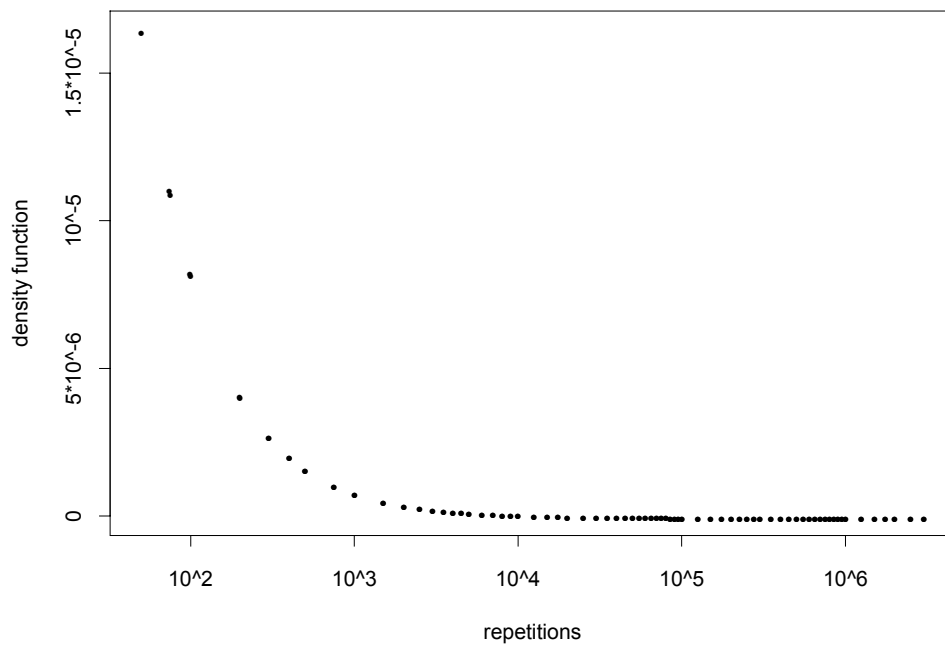

Figure 5.2. Weibull density function with $\lambda = 0.002$ and $\gamma = 0.412$.

Therefore, the survivor function can be expressed as

$$S(t) = 1 - \int_0^t f(u) du = 1 - \int_0^t \lambda \gamma u^{\gamma-1} \exp(-\lambda u^\gamma) du = 1 - \int_0^t \frac{d(\exp(-\lambda u^\gamma))}{du}$$

$$= \exp(-\lambda t^\gamma)$$

which results in

$$\ln(-\ln(S(t))) = \ln \lambda + \gamma \ln t$$

That is to say, if the Weibull assumption is tenable, where $\hat{S}(t)$ is the observed stiffness ratio, then a plot of $\ln(-\ln(\hat{S}(t)))$ against $\ln t$ should give an approximately straight line.

5.3.2 Weibull Proportional Hazards Model

To understand the Weibull proportional hazards model, it is necessary to comprehend the nature and significance of the Cox proportional hazards model (Cox 1972). The formula for the Cox PH model is:

$$h(t, X) = h_0(t) \exp\left(\sum_{i=1}^p \beta_i X_i\right)$$

where $h_0(t)$ = baseline hazard function, and $X = (X_1, X_2, \dots, X_p)$ = the covariates.

Another important definition pertinent to the derivation of the Weibull PH model is the hazard ratio (HR), which is defined as the hazard for one individual (or beam) divided by the hazard for a different individual (or beam). Two individuals can be distinguished by the set of different covariates, i.e., the X 's. The Cox PH model assumption requires that the HR stays constant over time.

$$HR = \frac{h(t, X^*)}{h(t, X)} = \text{constant}$$

It should be noted that in the Cox PH model, the baseline hazard ($h_0(t)$) is an unspecified function.

Recall that the survivor function and the hazard function with a Weibull density function can be expressed as follows:

$$S(t) = \exp(-\lambda t^\gamma),$$

and

$$h(t) = \frac{d(-\ln S(t))}{dt} = \lambda \gamma t^{\gamma-1}$$

For any laboratory fatigue test, imagine that there exists a baseline function such that

$$\frac{h_i(t)}{h_0(t)} = \frac{\lambda_i \gamma t^{\gamma-1}}{\lambda_0 \gamma t^{\gamma-1}} = \frac{\lambda_i}{\lambda_0} = \varphi$$

that is,

$$h_i(t) = \varphi h_0(t)$$

The Weibull PH model has the same formula as the Cox PH model, except that in the Weibull PH model the baseline function can be specified and expressed as

$$h_0(t) = \lambda \gamma t^{\gamma-1}$$

The φ cannot be negative as it is a function of test conditions and material variables.

One way to express and ensure the positiveness for any variable values is to use the exponential function.

Thus, if the survival time has a Weibull distribution, then the hazard function can be in the following form:

$$h(t, X) = \lambda \gamma t^{\gamma-1} \exp\left(\sum_{i=1}^p \beta_i X_i\right)$$

After performing substitution and integration, the general Weibull survivor function for various fatigue tests can be obtained as:

$$S(t, X) = \exp\left\{-\exp\left(\sum_{i=1}^p \beta_i X_i\right) \lambda t^\gamma\right\}$$

or

$$\ln(-\ln(S(t, X))) = \sum_{i=1}^p \beta_i X_i + \ln \lambda + \gamma \ln t \quad (5.1)$$

Thus, the Weibull PH model then transforms into a linear regression model. Hereafter, this linear regression model will be termed the Weibull equation. With the observations of the survivor function (stiffness ratio function in this case) and the relevant covariates (material variables, temperature and test strain level), the parameters, namely β_i , λ , and γ , can then be estimated.

5.4 Weibull Equations of WesTrack Project

5.4.1 An Example: Fitting the Weibull PH Model

The data to which the Weibull PH model is applied is the temperature sensitivity fatigue test data for WesTrack fine-plus gradation. Table 5.1 lists the material variables, testing strain levels, and the testing temperatures. Due to the large amount of stiffness ratio data from the duration of each test, they are not itemized here.

As seen from Figure 5.3 through Figure 5.5, the temperature and strain level have significant effects. In addition to this, three important observations can be made:

Table 5.1 Temperature Susceptibility Fatigue Test Results of WesTrack Fine-plus Gradation

Specimen	AV	AC	M200	r.s4s50	Temp.	Strain	Nf
WT12ET	5.0	5.35	6.0	2.92	5.1	0.000196	3872422
WT19ET	8.4	5.41	5.8	2.87	5.1	0.000178	923182
WT19FT	9.3	5.41	5.8	2.87	5.1	0.000296	144082
WT21AT	8.1	6.25	5.4	2.94	5.1	0.000400	25615
WT12FT	4.5	5.35	6.0	2.92	19.8	0.000198	3308278
WT11ET	8.8	5.50	5.5	3.10	19.7	0.000178	1191716
WT12DT	5.3	5.35	6.0	2.92	20.2	0.000298	194603
WT21BT	6.5	6.25	5.4	2.94	19.5	0.000401	25559
WT12AT	7.5	5.35	6.0	2.92	30.1	0.000199	925205
WT19CT	9.4	5.41	5.8	2.87	30.2	0.000181	820324
WT12CT	7.6	5.35	6.0	2.92	30.1	0.000300	174999
WT12BT	8.9	5.35	6.0	2.92	30.1	0.000404	49999

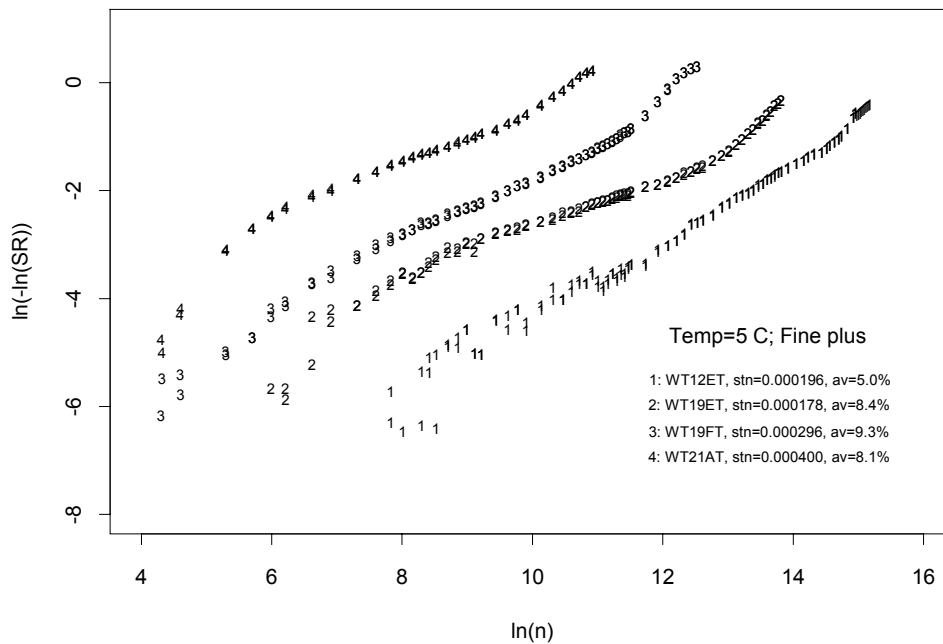

Figure 5.3. Weibull curves for fine-plus gradation at temperature 5°C.

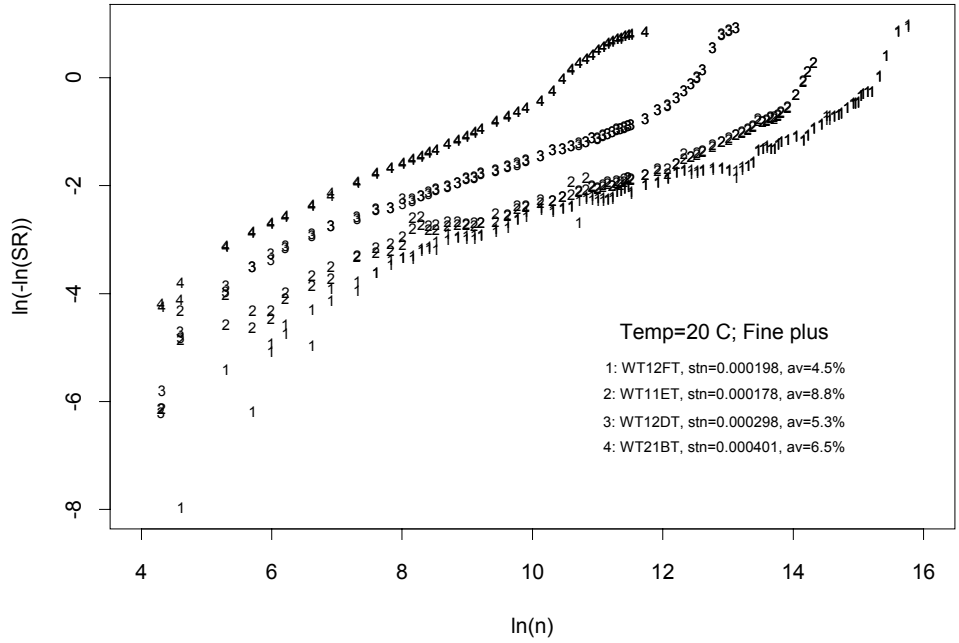

Figure 5.4. Weibull curves for fine-plus gradation at temperature 20°C.

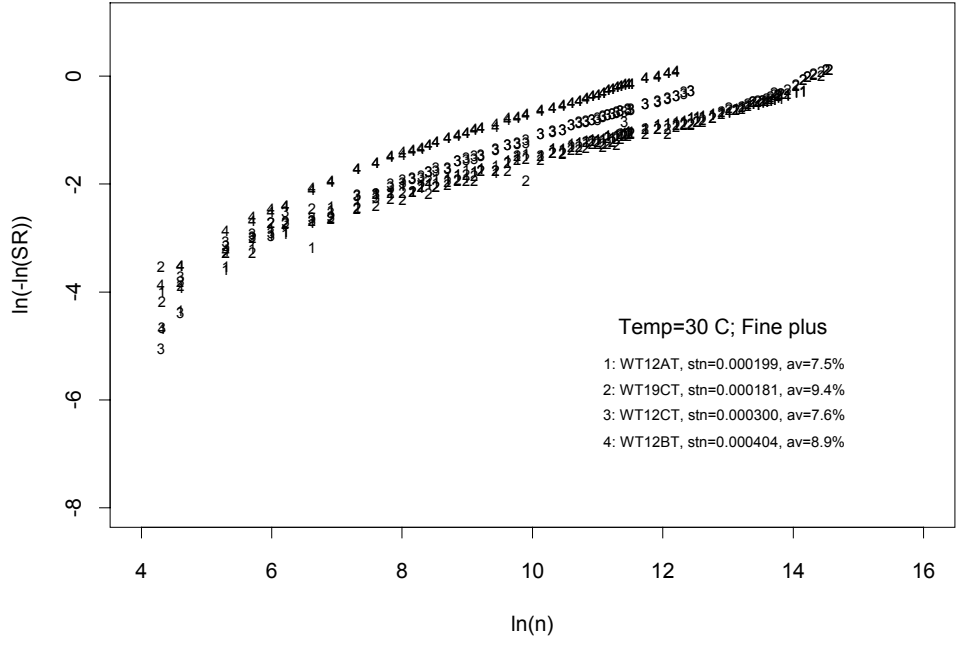

Figure 5.5. Weibull curves for fine-plus gradation at temperature 30°C.

All slopes are almost the same.

1. The intercept ($\ln \lambda + \sum_{i=1}^p \beta_i X_i$) of Equation 5.1 is definitely affected by the material variables and test conditions.
2. All the intercepts are negative.

The data lines in the plots of $\ln(-\ln(SR))$ against $\ln(n)$ of Figures 5.3 through 5.5 are reasonably straight, indicating that the Weibull assumption is adequate for dealing with the fatigue damage process of laboratory testing. It can be easily seen that in these figures, for the same test temperature, the lines are almost parallel in the order of test strain levels. The higher the test strain level, the bigger the numerical value of the intercept. Also, the effect of strain level on the space among the Weibull curves decreases as the test temperature increases. It indicates that there is interaction effect between the temperature and strain level.

The following shows the S-PLUS results of the regression equation.

```
Call: lm(formula = log( - log(sr)) ~ av + m200 + r.s4s50 + log(strain) + temp + t
emp *
      log(strain) + log(n))
Residuals:
    Min       1Q   Median       3Q      Max
-4.525 -0.2541  0.03081  0.3204  1.245

Coefficients:
              Value Std. Error  t value Pr(>|t|)
(Intercept)  31.1304   1.2732   24.4508  0.0000
          av    0.1027   0.0099   10.4026  0.0000
          m200 -1.3976   0.1131  -12.3546  0.0000
          rs4s50 -2.7272   0.3066   -8.8964  0.0000
    log(strain)  2.8252   0.1238   22.8140  0.0000
          temp  -0.2448   0.0451   -5.4254  0.0000
          log(n)  0.4935   0.0058   84.8145  0.0000
temp:log(strain) -0.0355   0.0054   -6.6206  0.0000

Residual standard error: 0.5183 on 1369 degrees of freedom
Multiple R-Squared: 0.8674
F-statistic: 1279 on 7 and 1369 degrees of freedom, the p-value is 0
```

Notice that each term in this application model is significant and the multiple R-squared is 0.8674. The *rs4s50* term appearing as a significant item in this equation could be due to the

data variation; otherwise, for the same mix the *rs4s50* should be the same. The final Weibull PH model then is

$$E(\ln(-\ln(SR))) = \underset{(1.2732)}{31.1304} + \underset{(0.0099)}{0.1027} av - \underset{(0.0451)}{0.2448} temp - \underset{(0.3066)}{2.7272} rs4s50 - \underset{(0.1131)}{1.3976} m200 \\ + \underset{(0.1238)}{2.8252} \ln(stn) + \underset{(0.0058)}{0.4935} \ln(n) - \underset{(0.0054)}{0.0355} temp \cdot \ln(stn)$$

where

SR = stiffness ratio,
av = percent air-void content,
m200 = percent passing #200 (0.075 mm) sieve,
rs4s50 = ratio of percent passing #4 (4.75 mm) and #50 (0.3 mm) sieves,
 ln = natural logarithm,
stn = microstrain,
temp = test temperature (°C), and
n = repetition.

The number embraced by the parentheses is the standard error of the regression coefficient. The “E” at beginning of the equation stands for the “expected” and the present style is really a strict statistical model specification, otherwise an error term should be specified in the equation. It should be noted that the *av*, *lnstn* and *lnn* have positive coefficients, whereas the *m200*, *rs4s50*, *temp*, and the interaction term *temp · ln(stn)* have negative coefficients. To interpret the physical meaning of these coefficients, make a simple example of the change of percent air-void content to the effect of stiffness ratio, based on the obtained regression equation.

Example: Two mixes, A and B, have the same material and environmental variables except one has 8 percent *av*, the other has 5 percent *av*, respectively. Thus, to reach the same stiffness ratio, say *sr_t*,

$$\text{For mix A: } \ln(-\ln(sr_t)) = C + 0.1027 \times 8 + 0.4935 \ln n_A$$

$$\text{For mix B: } \ln(-\ln(sr_t)) = C + 0.1027 \times 5 + 0.4935 \ln n_B$$

Subtracting formula B from formula A,

$$0.1027 \times (8 - 5) + 0.4935 \left(\ln \frac{n_A}{n_B} \right) = 0 \Rightarrow \ln \frac{n_A}{n_B} = -0.6243 \Rightarrow n_A = 0.536 n_B$$

That is to say that mix B (with 5 percent *av*) needs almost twice the repetitions to reach the same stiffness ratio as mix A does. In other words, mix A fails faster than mix B. Since the *av*, $\ln(stn)$ and $\ln(n)$ have the positive coefficients in the model, their effects to the stiffness reduction are negatively correlated: the higher the values, the quicker the failure.

The temperature has a negative coefficient in the model; therefore, the higher the temperature, the slower the failure. The temperature range of this application model is from 5°C to 30°C.

Figure 5.6 displays the comparison of the application model (solid line in plots) and real data in the plots of $\ln(-\ln(SR))$ against $\ln(n)$ for each specimen. In this experiment, the fitting is quite promising and satisfactory. The model replicates the main trend of each specimen. Of great importance for the Weibull dynamic approach is that a single equation derived from the Weibull PH model can reflect all of the individual tests performed in the laboratory.

5.4.2 Weibull Equation of Coarse Gradation

The intent of estimating the Weibull equation is to try to incorporate this equation, along with other inputs, to conduct a computer-based simulation of the Weibull dynamic approach for predicting fatigue performance of WesTrack project sections. Before discussing the algorithm of the Weibull dynamic approach, a more thorough evaluation of the corresponding Weibull equations for all of the WesTrack gradations is discussed.

The procedure for model selection is the same procedure described as in Chapter 4. Henceforth, the details will be hidden, and only the final model is listed and discussed. The data

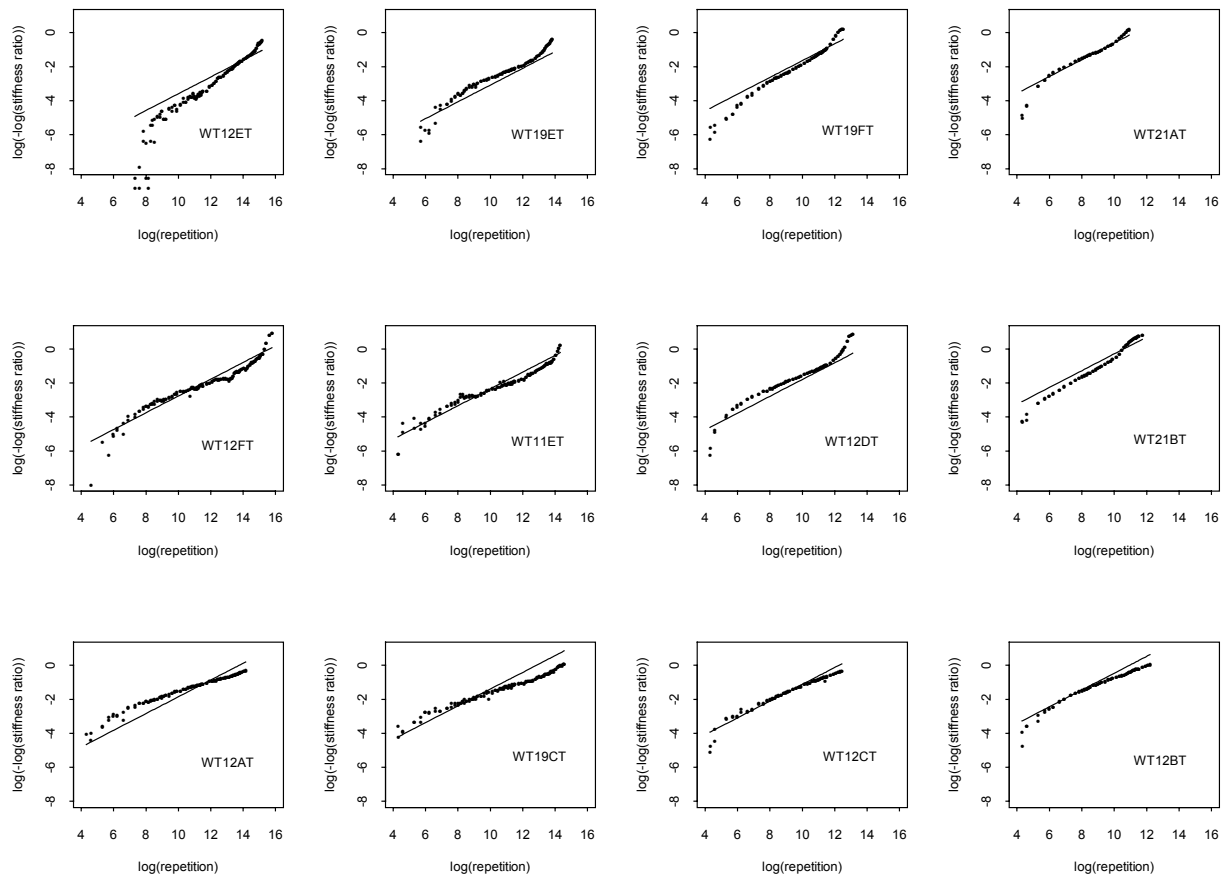

Figure 5.6. Weibull regression fitting and real data for fine-plus gradation.

utilized to estimate the Weibull equation is the same data set used to obtain the conventional coarse stiffness equation in Chapter 4. For the coarse gradation, the final model chosen is listed below.

$$\begin{aligned}
 E(\ln(-\ln(SR))) = & 105.8248 - 1.8679 av + 17.4844 \ln stn + 1.1902 temp - 10.3682 rs4s50 \\
 & \quad (8.6671) \quad (0.0793) \quad (0.8926) \quad (0.1702) \quad (1.2809) \\
 & - 8.8144 m200 + 4.8639 \ln(\ln(n)) - 0.1674 av \cdot \ln stn - 0.0110 av \cdot temp \\
 & \quad (0.6664) \quad (0.1027) \quad (0.0075) \quad (0.0009) \\
 & + 0.2041 av \cdot rs4s50 - 0.0237 av \cdot \ln(\ln(n)) - 0.0786 \ln stn \cdot temp \\
 & \quad (0.0097) \quad (0.0076) \quad (0.0030) \\
 & - 1.5698 \ln stn \cdot rs4s50 - 1.3200 \ln stn \cdot m200 - 0.2416 temp \cdot rs4s50 \\
 & \quad (0.1303) \quad (0.0701) \quad (0.0262) \\
 & - 0.1082 temp \cdot m200 - 0.0534 temp \cdot \ln(\ln(n)) \\
 & \quad (0.0129) \quad (0.0036)
 \end{aligned}$$

$$R^2 = 0.83$$

The covariates have the same definition and unit as described in Chapter 4. The corresponding S-PLUS output of the regression equation is as follows:

```
Call: lm(formula = llsr ~ av + lnstn + temp + rs4s50 + m200 + lln + av * lnstn +
av * temp + av * rs4s50 + av * lln + lnstn * temp + lnstn * rs4s50 + lnstn * m200 + temp * rs4s50
+ temp * m200 + temp * lln)
```

```
Residuals:
    Min       1Q   Median       3Q      Max
-3.506  -0.257  0.03644  0.3304  1.519
```

```
Coefficients:
                Value Std. Error  t value Pr(>|t|)
(Intercept)  105.8248    8.6671   12.2100  0.0000
          av     -1.8679    0.0793  -23.5662  0.0000
        lnstn    17.4844    0.8926   19.5877  0.0000
         temp     1.1902    0.1702    6.9910  0.0000
        rs4s50  -10.3682    1.2809   -8.0942  0.0000
         m200    -8.8144    0.6664  -13.2276  0.0000
          lln     4.8639    0.1027   47.3504  0.0000
    av:lnstn   -0.1674    0.0075  -22.2370  0.0000
    av:temp    -0.0110    0.0009  -12.8006  0.0000
  av:rs4s50    0.2041    0.0097   21.1038  0.0000
    av:lln    -0.0237    0.0076   -3.1378  0.0017
 lnstn:temp   -0.0786    0.0030  -26.0603  0.0000
lnstn:rs4s50  -1.5698    0.1303  -12.0453  0.0000
 lnstn:m200   -1.3200    0.0701  -18.8390  0.0000
temp:rs4s50   -0.2416    0.0262   -9.2205  0.0000
temp:m200     -0.1082    0.0129   -8.4121  0.0000
temp:lln     -0.0534    0.0036  -14.9808  0.0000
```

```
Residual standard error: 0.4827 on 8238 degrees of freedom
Multiple R-Squared: 0.8254
F-statistic: 2434 on 16 and 8238 degrees of freedom, the p-value is 0
```

Figure 5.7 displays the residual plots for this regression model. Figure 5.7a illustrates the residual versus the fitted values. Keep in mind that, for a given testing condition, the applied Weibull equation represents a stiffness deterioration curve; hence, in the residual plot it will be close to a line. Looking at the residual plot, the pattern is generally acceptable. Notice, however, that there is a group of points with fitted values greater than 0. It is conjectured that some tests included in this set proceeded to the crack propagation stage. Figure 5.7b indicates the assumption of constant variance (homoscedasticity) is valid, except for some potential outliers. Figures 5.7c and 5.7d show that the distribution of residual values is very close to normal; however, some outliers make it skew to the left.

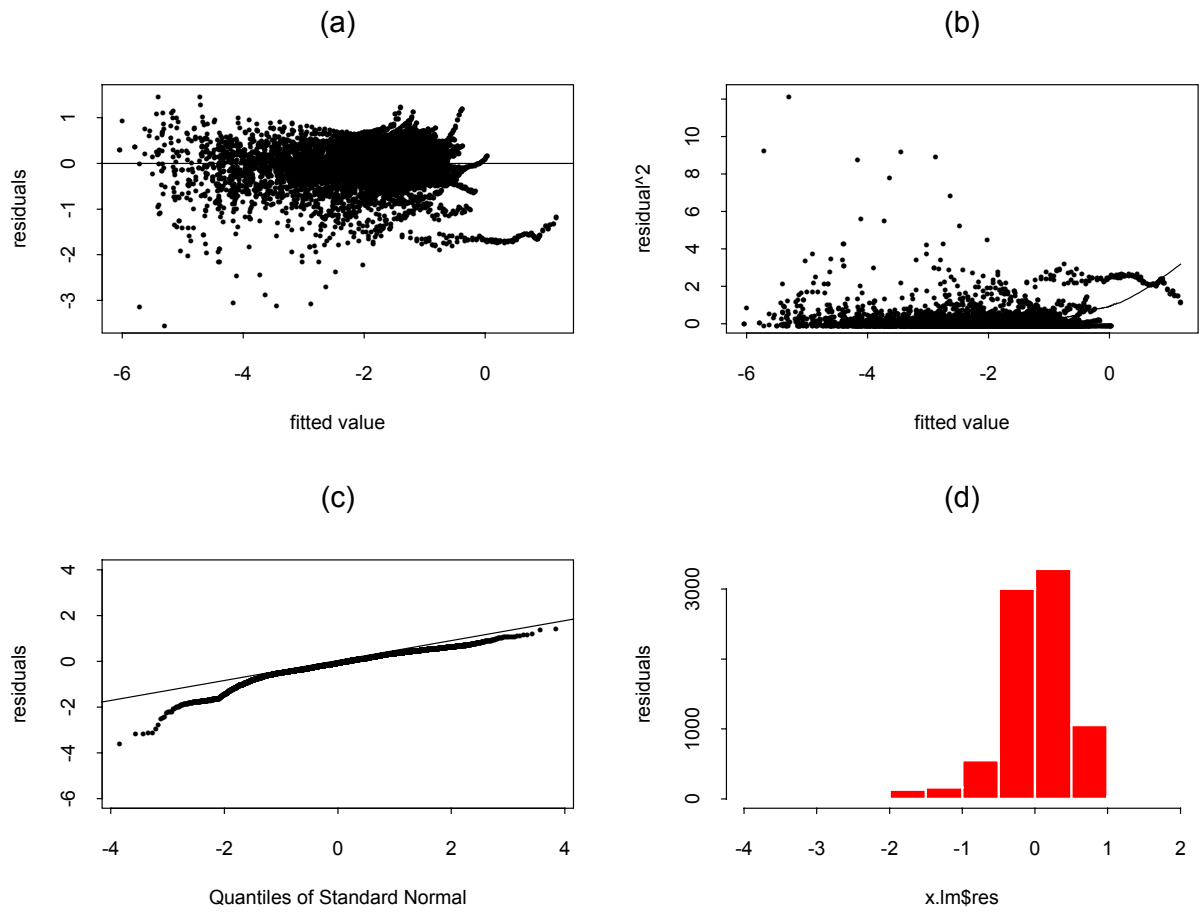

Figure 5.7. Residual plots of Weibull regression equation for coarse gradation.

5.4.3 Weibull Equation of Fine and Fine-Plus Gradations

The data utilized to estimate the Weibull equation is the same data set used to obtain the conventional fine and fine-plus stiffness equations in Chapter 4. For the fine and fine-plus gradations, the final model selected is presented here:

$$\begin{aligned}
 E(\ln(-\ln(SR))) = & -55.4911 + 7.0102 ac + 0.6083 av + 0.4755 temp - 1.3899 \ln stn \\
 & + 7.0609 rs4s50 + 0.9143 m200 + 8.0053 \ln(\ln(n)) - 0.0528 ac \cdot av \\
 & - 0.0753 ac \cdot temp + 0.1186 ac \cdot \ln stn - 1.0103 ac \cdot rs4s50 \\
 & - 0.2657 ac \cdot m200 + 0.0908 ac \cdot \ln(\ln(n)) - 0.0045 av \cdot temp \\
 & + 0.0177 av \cdot \ln stn - 0.0266 av \cdot rs4s50 - 0.0057 av \cdot m200 \\
 & + 0.0340 av \cdot \ln(\ln(n)) - 0.0776 temp \cdot \ln stn - 0.1069 temp \cdot rs4s50 \\
 & - 0.0296 temp \cdot m200 - 0.0661 temp \cdot \ln(\ln(n)) + 0.4191 \ln stn \cdot rs4s50 \\
 & + 0.1871 \ln stn \cdot m200 + 0.5835 \ln stn \cdot \ln(\ln(n)) + 0.8220 rs4s50 \cdot m200 \\
 & + 0.2449 rs4s50 \cdot \ln(\ln(n)) + 0.1018 m200 \cdot \ln(\ln(n))
 \end{aligned}$$

$$R^2 = 0.91$$

The following lists the relevant S-PLUS results of the regression equation.

```
Call: lm(formula = llsr ~ ac + av + temp + lnstn + rs4s50 + m200 + lln + ac * av
+ ac * temp + ac * lnstn + ac * rs4s50 + ac * m200 + ac * lln + av * temp + av * lnstn + av *
rs4s50 + av * m200 + av * lln + temp * lnstn + temp * rs4s50 + temp * m200 + temp * lln + lnstn *
rs4s50 + lnstn * m200 + lnstn * lln + rs4s50 * m200 + rs4s50 * lln + m200 * lln)
```

Residuals:

Min	1Q	Median	3Q	Max
-3.643	-0.1289	0.01508	0.1742	1.408

Coefficients:

	Value	Std. Error	t value	Pr(> t)
(Intercept)	-55.4911	4.2948	-12.9204	0.0000
ac	7.0102	0.5779	12.1298	0.0000
av	0.6083	0.0558	10.8974	0.0000
temp	0.4755	0.0922	5.1562	0.0000
lnstn	-1.3899	0.3329	-4.1744	0.0000
rs4s50	7.0609	1.0012	7.0526	0.0000
m200	0.9143	0.2540	3.5997	0.0003
lln	8.0053	0.4530	17.6705	0.0000
ac:av	-0.0528	0.0027	-19.6552	0.0000
ac:temp	-0.0753	0.0035	-21.7018	0.0000
ac:lnstn	0.1186	0.0214	5.5394	0.0000
ac:rs4s50	-1.0103	0.1395	-7.2427	0.0000
ac:m200	-0.2657	0.0292	-9.0998	0.0000
ac:lln	0.0908	0.0241	3.7746	0.0002
av:temp	-0.0045	0.0003	-14.8512	0.0000
av:lnstn	0.0177	0.0040	4.4628	0.0000
av:rs4s50	-0.0266	0.0111	-2.3969	0.0165

av:m200	-0.0057	0.0026	-2.2078	0.0273
av:lln	0.0340	0.0045	7.5070	0.0000
temp:lnstn	-0.0776	0.0017	-46.3067	0.0000
temp:rs4s50	-0.1069	0.0169	-6.3401	0.0000
temp:m200	-0.0296	0.0054	-5.5093	0.0000
temp:lln	-0.0661	0.0019	-34.0057	0.0000
lnstn:rs4s50	0.4191	0.0705	5.9465	0.0000
lnstn:m200	0.1871	0.0192	9.7235	0.0000
lnstn:lln	0.5835	0.0307	19.0056	0.0000
rs4s50:m200	0.8220	0.0329	24.9925	0.0000
rs4s50:lln	0.2449	0.0879	2.7857	0.0053
m200:lln	0.1018	0.0230	4.4289	0.0000

Residual standard error: 0.3304 on 14720 degrees of freedom
Multiple R-Squared: 0.9132
F-statistic: 5529 on 28 and 14720 degrees of freedom, the p-value is 0

Figure 5.8 presents the residual plots for this regression model. The same conclusions as for the coarse regression are pertinent to the residual plots of this fine and fine-plus regression, except that the R-squared of this regression is higher. These two obtained Weibull equations, coarse and fine and fine-plus, will be utilized as the input of the *Weibull* program in Chapter 7.

5.5 Prediction of Fatigue Performance Using Weibull Theory

Now it is time to explore how the Weibull theory can be applied to prediction of the in-situ fatigue performance. Recall that both the general hypothesis of fatigue damage postulated in Chapter 4, as well as the other significant assumption made to complete the procedure: that the fatigue damage is irrecoverable in whatever situation. The assumptions that center the algorithm of the fatigue performance prediction are summarized as follows,

1. *For every testing situation containing many variables, there exists one and only one associated stiffness deterioration curve in the SR-N space. If the testing situation changes from one state to the other at a given instant (repetition), the stiffness deterioration rate will follow the rate of the new state, starting immediately at that specific instant (repetition).*
2. *The SR cannot be increased.*

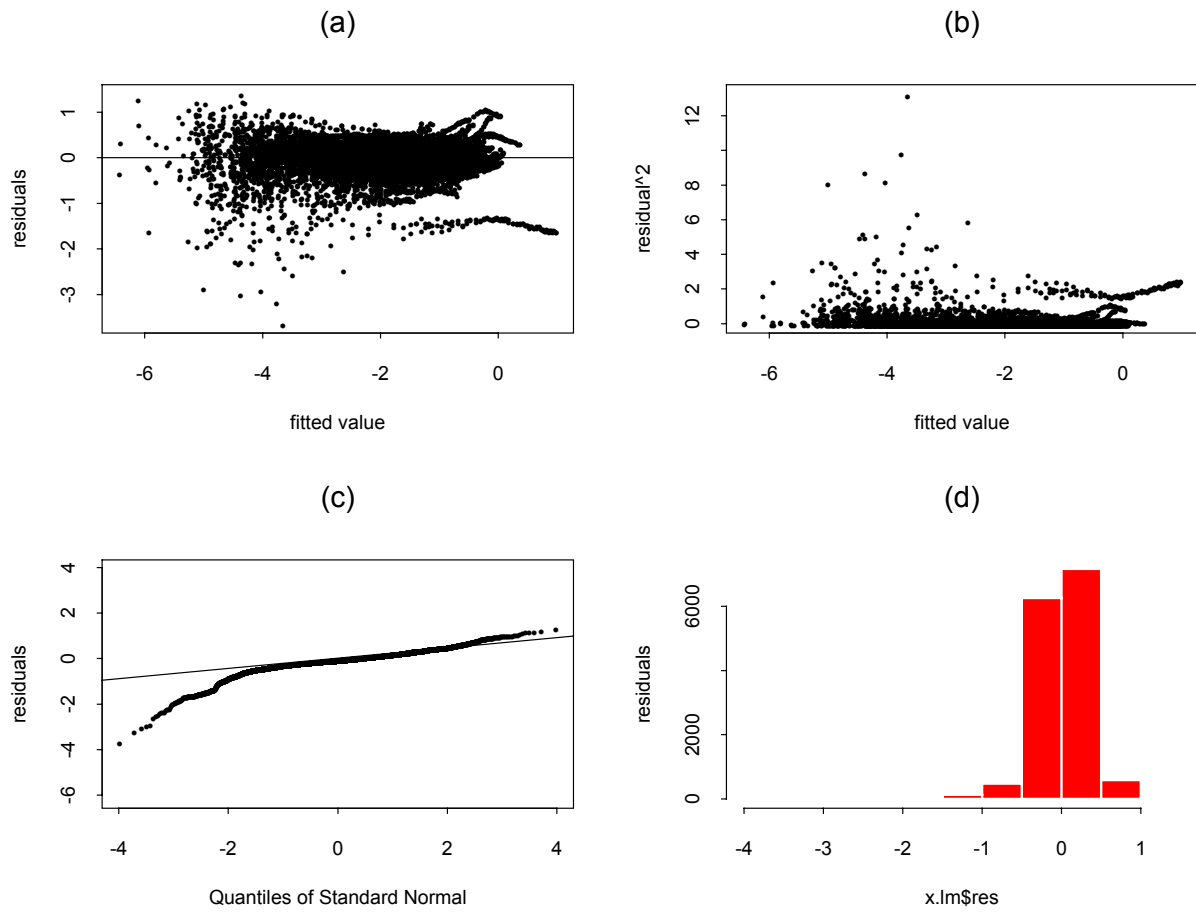

Figure 5.8. Residual plots of Weibull regression equation for fine and fine-plus gradations.

Figure 5.9 is a schematic illustration of the general hypothesis of fatigue damage. Two stiffness deterioration curves, representing situations 1 and 2, are shown on this figure. At time (or repetition) $t - \Delta t$, the material begins to deteriorate along the situation 1 curve for Δt time (or repetitions) of traffic loading. During this period, the stiffness of the material was reduced by the amount $\Delta SR_{t-\Delta t \rightarrow t}^{(1)}$, which is the difference of stiffness ratio from $t - \Delta t$ to t at situation 1. Suddenly, the situation changes from 1 to 2 at time t . According to the general hypothesis of fatigue damage, the stiffness deterioration rate will follow the rate of the situation 2, starting immediately at time t . After Δt passing, the total stiffness deterioration will be $\Delta SR_{t \rightarrow t+\Delta t}^{(2)}$, which means the difference of stiffness ratio from t to $t + \Delta t$ at situation 2.

Figure 5.10 demonstrates how the irrecoverable assumption of fatigue damage (assumption 2) can be applied to the Weibull dynamic approach to find the material's true stiffness deterioration curve. Assume the stiffness ratio at time $t - \Delta t$ is $SR_{t-\Delta t}^{(0)}$. Then, the stiffness ratio at time t is going to be $SR_t^{(1)} = SR_{t-\Delta t}^{(0)} + \Delta SR_{t-\Delta t \rightarrow t}^{(1)}$; likewise, the stiffness ratio at time $t + \Delta t$ will be $SR_{t+\Delta t}^{(2)} = SR_t^{(1)} + \Delta SR_{t \rightarrow t+\Delta t}^{(2)}$.

By repeating this procedure, the fatigue damage caused by the situation change is then clearly and dynamically described. This iteration procedure is the essence of the *Weibull* program included in Appendix E. The Weibull equation is an equation that can include all the situations, making it very easy to calculate the ΔSR after each time step Δt .

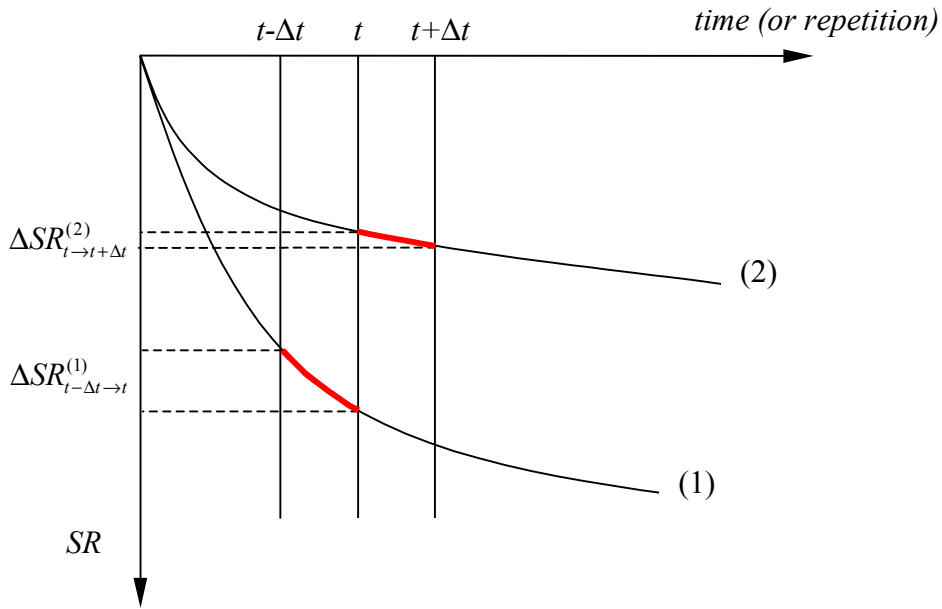

Figure 5.9. Change of stiffness ratios along various stiffness deterioration curves.

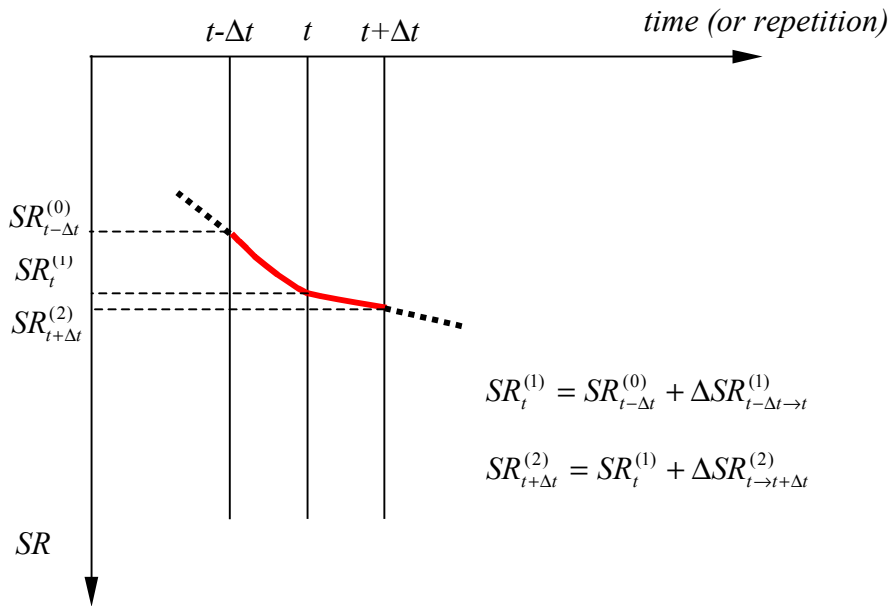

Figure 5.10. Construction of the compound stiffness deterioration curve with Weibull dynamic approach.

5.6 Miner's Law and Weibull Theory

In 1945, Miner proposed a hypothesis of cumulative damage to explain the fatigue life of aluminum alloys of aircraft. The hypothesis was simply expressed as,

$$\sum \frac{n_i}{N_i} = 1 \quad (5.2)$$

where

n_i = number of repetitions applied at i th stress, and

N_i = number of repetitions to failure at i th stress.

The equation states that the failure of a material subjected to a series of stresses, will, due to the cumulative damage, occur at a time when the $\sum \frac{n_i}{N_i}$ is equal to unity. It should be noted that the emphasis was on different stress levels and not on various strain levels. Not until 1960 did Saal and Pell suggest that, instead of stress, strain would seem to be the appropriate criterion when applying Miner's Law to asphalt concrete.

In 1961, Monismith et al. related Miner's Law to asphalt pavement design in such a way that a satisfactory design should fulfill the criterion $\sum \frac{n_i}{N_i} \leq 1$. Notice that during this stage Miner's Law was related to not only the strain but to the combination of fatigue life and various strain levels. This increases the applicability of the controlled-strain flexural fatigue test, for strain-versus-fatigue-life is the typical test result. As illustrated in Figure 5.11, if $\sum \frac{n_i}{N_i}$ equals unity, cracking will develop at the end of design life; if $\sum \frac{n_i}{N_i}$ is greater than unity, cracking will develop before the end of design life. In the latter case, the thickness of the pavement or the properties of mix should be modified to reduce the maximum tensile strain occurring at the

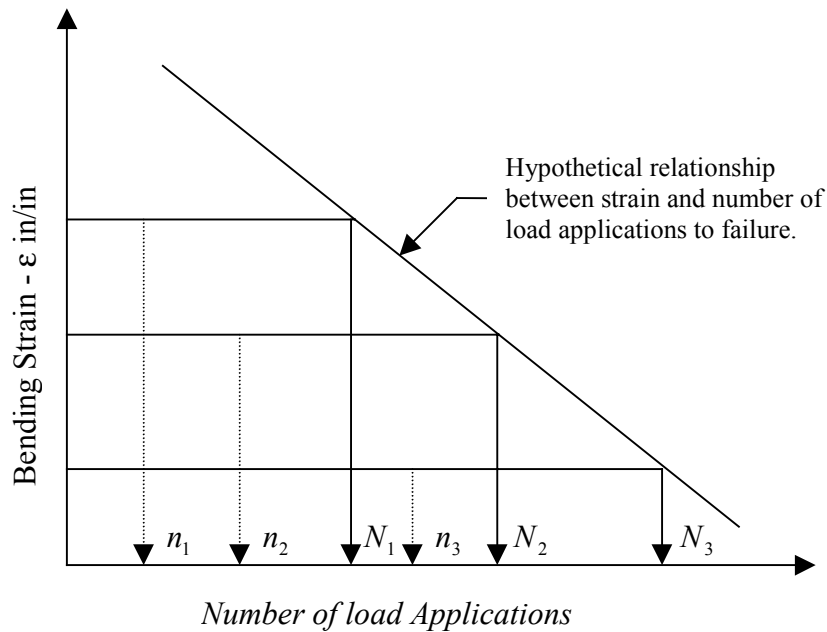

Figure 5.11. Prediction of fatigue life (adapted from Monismith, et al., 1961).

asphalt concrete layer so that Miner's Law result is kept below unity for the desired number of repetitions.

5.6.1 Miner's Law in Explanation with Stiffness Ratio

Conventionally, the fatigue life is defined as the fatigue-resistant capacity to withstand repetitive flexural bending without cracking; however, in a controlled-strain fatigue test, the fatigue life is defined as when the mix stiffness reaches a 50 percent reduction from the initial stiffness. From the standpoint of stiffness ratio, such a definition requires and predicts only two points in the plot of repetitions versus stiffness ratio, the first point being—repetition 0, stiffness ratio 1, and the second point—fatigue life, stiffness ratio 0.5. This will construct a straight line in the repetitions versus stiffness ratio plot.

Miner's Law is worth considering from the standpoint of stiffness deterioration. Before starting this argument, it's beneficial to explore Miner's Law in a little more depth. Take, for example, the Miner's Law $\sum_{i=1}^p \frac{n_i}{N_i} = 1$. It is assumed that there are p situations in conducting controlled-strain fatigue tests and each single test represents a specified situation. From the point of view of linear algebra, the reciprocal set of N_i , i.e., $\left\{ \frac{1}{N_1}, \frac{1}{N_2}, \dots, \frac{1}{N_p} \right\}$, will form a base for the equation $\sum_{i=1}^p \frac{n_i}{N_i} = 1$, which is also a linearly independent set. More important, this base will construct a linear space (or vector space) and thus inherit the properties of addition and scalar multiplication. These properties infer that the cumulative fatigue damage is additive and thus cannot be recovered. Notice that in the reciprocal set of N_i , i.e., $\left\{ \frac{1}{N_1}, \frac{1}{N_2}, \dots, \frac{1}{N_p} \right\}$, each element in this set represents the fatigue damage rate, that is, the $1/N_i$ portion of total available fatigue life lost when one loading repetition is applied on the i th situation. Figure 5.12 plots the linear relationship of repetitions versus stiffness ratio according to conventional controlled-strain fatigue test results. As illustrated in Figure 5.12,

$$\frac{n_i}{N_i} = \frac{\Delta SR_i}{SR_{0.5}} \quad (5.3)$$

where

- ΔSR_i = the loss of stiffness ratio due to apply n_i repetitions at i th situation,
- $SR_{0.5}$ = the stiffness ratio at which stiffness is 50 % reduction of its initial value.

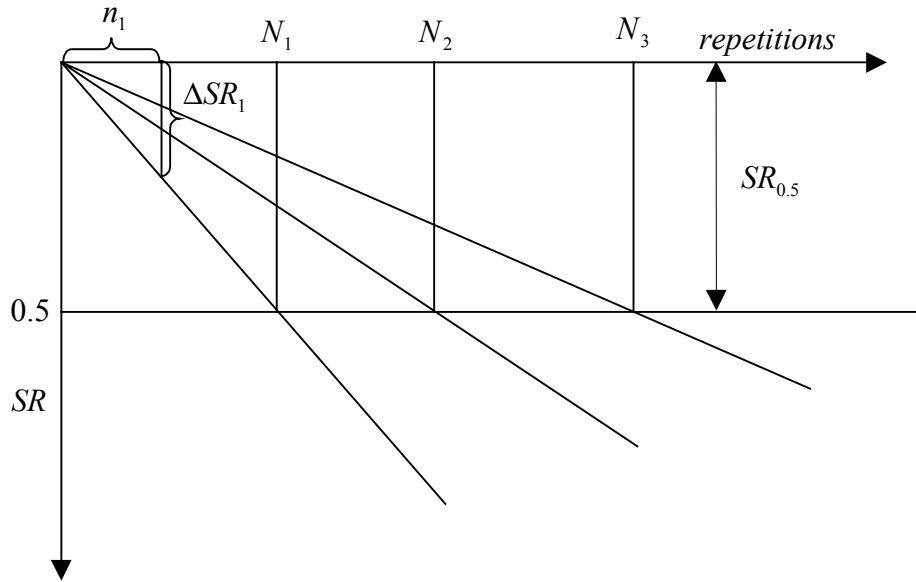

Figure 5.12. Miner's Law in explanation with stiffness ratio and fatigue life.

Therefore, Miner's Law can be expressed as

$$\sum \frac{n_i}{N_i} = \sum \frac{\Delta SR_i}{SR_{0.5}} = 1$$

and results in

$$\sum \Delta SR_i = SR_{0.5} \quad (5.4)$$

Notice that,

$$\Delta SR_i = \frac{1}{N_i} \times n_i \times SR_{0.5}$$

$\frac{1}{N_i}$ and $SR_{0.5}$ are constants. It shows that the ΔSR_i is linearly proportional to n_i ; in

other words, ΔSR_i is a linear function of n_i with a slope $\frac{SR_{0.5}}{N_i}$. If the stiffness deterioration is

regarded as an index of fatigue damage, then Miner's Law implicitly indicates that the fatigue

damage cannot be recovered. The cumulative fatigue damage is then the sum of stiffness loss contributed by each single application of loading.

5.6.2 Generalized Miner's Law

Generally speaking, Miner's Law does not explicitly indicate the linearity of the relationship n_i/N_i , if viewed in terms of stiffness ratio. Obviously, in Equation 5.3, the linearity of n_i/N_i depends on the linearity of ΔSR_i .

In Figure 5.12, based on the conventional fatigue life definition, ΔSR_i is in proportion to n_i during the whole stiffness deterioration process; however, this is not necessarily the case. If the stiffness deterioration process can be suitably described by a Weibull function, then

$\Delta SR_i = W_i(n_{i-1} + \Delta n_i) - W_i(n_{i-1})$, where W_i is the Weibull function at the i th situation, and n_{i-1} is the cumulative loading repetitions before applying Δn_i loading repetitions. Since the Weibull function is nonlinear, ΔSR_i is no longer in proportion to n_i and exhibits nonlinear aspects.

However, the Equation 5.4 will still hold for predicting cumulative fatigue damage. Remember that this equation is actually the same approach utilized in the Weibull fatigue damage prediction algorithm. Therefore, the Weibull theory extends the interpretation of Miner's Law into a nonlinear domain.

In sum, Miner's Law can be applied either to the linear domain or to a nonlinear domain. It should be noted that the Weibull theory is just an instance of the generalized Miner's Law, for it is probable that functions other than the Weibull function can efficiently describe the fatigue damage process.

Regarding the Weibull approach as a special instance of the generalized Miner's Law, several points can be addressed to further extend and interpret the hypothesis of Miner's Law.

1. The linearity of Miner's Law depends on how you choose and define the second dimension space, in this case, the stiffness ratio.
2. No matter what linear or nonlinear functions are used to describe the fatigue damage process, the loading sequence will decide the time to reach the fatigue failure and therefore the loading sequence cannot be exchanged in Equation 5.2.
3. The fatigue damage cannot be increased regardless of the linear or nonlinear functions utilized.
4. Once the failure criteria are determined, the linear function, conventional controlled-strain fatigue test result, or a nonlinear function such as the Weibull function, will have the same fatigue lives.
5. As shown in Figure 5.13, the time to reach pre-defined failure is eventually the same for both linear and nonlinear functions. The linear approach actually utilizes the average fatigue damage rate as opposed to the sharp to flat damage rate of the Weibull function. The fatigue damage process is thus path-independent; that is to say, either a linear approach or Weibull's nonlinear approach will reach the same failure time. However, the Weibull approach preserves the intermediate information of the fatigue damage process.

It seems that Miner's Law, using its linear methodology, will provide quite satisfactory prediction in fatigue life prediction for compound loading cases. As might be expected, the prediction results from both linear or nonlinear approaches should have a certain degree of consistency. Chapter 6 will present the results of simulation of the WesTrack experiment using

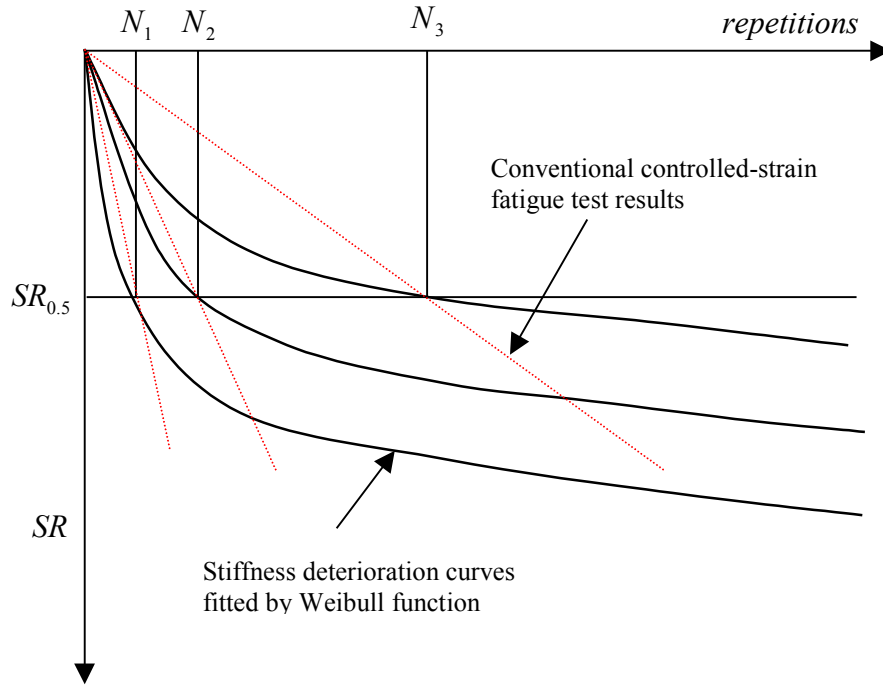

Figure 5.13. Comparison between Miner's Law and Weibull theory.

the linear Miner's Law. Chapter 7 will illustrate the simulation results using the Weibull approach.

5.7 Weibull Accelerated Failure Time Model

5.7.1 Introduction

Laboratory testing is extremely valuable and irreplaceable in pavement design, for it is the most economical and efficient way to evaluate the mix properties before the pavement is built. The information obtained from the laboratory must be applied to prediction of the performance of a proposed pavement. However, it is inefficient and very difficult to make the boundary conditions of laboratory tests exactly match those of field pavements. As a

consequence, a correction factor is needed to correct the gap caused by different boundary conditions. It has been recognized that the correction factor to translate laboratory fatigue test results into the real pavement performance should not be taken for granted. Instead, to predict the in-situ fatigue performance, it is important to understand every aspect of the correction factor. The following discussion will explain how the Weibull accelerated failure time model can be used to correct for the boundary condition effect.

The Weibull accelerated failure time model is discussed here to evaluate how the stiffness deterioration curve is deviated from the Weibull curve obtained in laboratory due to the difference of boundary conditions. It should be noted that the comparison between field curves and laboratory curves needs to be made under the same test conditions, i.e., temperature, loading frequency, etc. These conditions, if not the same, should be as similar as possible to eliminate a potential variance or bias.

The data source used in this discussion is from the test results of Section 503RF performed as part of Goal 1 of the CAL/APT Strategic Plan (California Department of Transportation 1995). Section 503RF was a full-scale pavement constructed at the Richmond Field Station that was designed and constructed according to Caltrans procedures and contains an asphalt concrete layer on untreated aggregate base and subbase. In addition to these field performance data, several laboratory fatigue tests with the same mixes (field-mixed and field-compacted) are utilized to verify the feasibility of the Weibull accelerated failure time model. One major reason for having chosen Section 503RF is its well-controlled test temperature, which was maintained at $20 \pm 3^{\circ}\text{C}$.

Without the aid of the back-calculated layer moduli, this discussion of the Weibull accelerated failure time model cannot be performed. The methodology of back-calculation

utilized here is based on a Microsoft EXCEL spreadsheet developed by Per Ullidtz (1999). The layer moduli were calculated using the collected multi-depth deflectometer (MDD) data and a five-layer pavement system.

A demonstration example combining the laboratory fatigue test results and the back-calculated moduli of asphalt concrete is presented so as to certify the feasibility of the Weibull accelerated failure time model. In addition to this, the mode factor, controlled-strain fatigue tests, and controlled-stress fatigue tests are discussed in a general way.

5.7.2 Accelerated Failure Time Model

The following paragraph will focus on a general discussion of the accelerated failure time model. The independent variable, stiffness, or stiffness ratio of asphalt concrete, as measured in the field is assumed to act multiplicatively on the time scale relative to the stiffness observed in the laboratory. Intuitively, the model can be utilized as a comparison measurement in terms of the speed of the stiffness deterioration process between the fatigue tests conducted in the laboratory and fatigue performance in the field. It is postulated that the stiffness deterioration process in the field pavement follows a Weibull function.

Under an accelerated failure time model, the survival time of a beam tested in the laboratory is taken to be a multiple of the survival time obtained from back-calculation in the field. Thus the effect owing to different boundary conditions is to increase or decrease the damage caused by each load application. Under this assumption, the probability that a beam tested in the laboratory survives beyond time t is the probability that a pavement in the field survives beyond time ϕt , where ϕ is an unknown, positive constant. The ϕ term is also identified as the shift factor, a correction factor to be multiplied by the laboratory fatigue life to

obtain the corresponding fatigue life in the field, and is for the most part caused by the differences of boundary conditions between laboratory and field. The ϕ term will be verified by comparing the back-calculation moduli from MDD data of Section 503RF to the fatigue test results from the laboratory.

Now let $S_{Lab}(t)$ and $S_{Field}(\phi t)$ be the survivor functions for laboratory and field respectively. Then, the accelerated failure time model specifies that

$$S_{Lab}(t) = S_{Field}(\phi t)$$

for any value of the survival time t .

Following the relationship between the survivor function $S(t)$, probability density function $f(t)$ and hazard function $h(t)$, the relationship between the density and hazard functions can be derived as follows.

Taking the derivative with respect to time of the equation above,

$$\frac{dS_{Lab}(t)}{dt} = \frac{dS_{Field}(\phi t)}{dt}$$

you have

$$f_{Lab}(t) = \phi f_{Field}(\phi t)$$

According to the definition of the hazard function

$$\frac{f_{Lab}(t)}{S_{Lab}(t)} = \frac{\phi f_{Field}(\phi t)}{S_{Field}(\phi t)}$$

you obtain

$$h_{Lab}(t) = \phi h_{Field}(\phi t)$$

that is,

$$h_{Field}(t) = \phi^{-1} h_{Lab}(\phi^{-1} t)$$

The parameter ϕ must be non-negative; therefore, it is convenient to set ϕ as an exponential function e^{β} , if the Weibull proportional hazards model is utilized. This Weibull function is not to be confused with a Weibull distribution, for the fatigue damage process is a consecutive process with time, which should not be considered as the survival time value arrived at by following a Weibull distribution. The stiffness deterioration process, namely the survivor function or the fatigue damage process, of laboratory fatigue tests is assumed to follow a Weibull function and its baseline hazard function is supposed to have the form

$$h_{Lab}(t) = \lambda\gamma t^{\gamma-1}$$

Under the assumption that the stiffness deterioration process of laboratory fatigue tests is a Weibull function with scale parameter λ and shape parameter γ , the hazard function of the accelerated failure time model for the field performance can be represented as the following:

$$h_{Field}(t) = \phi^{-1} h_{Lab}(\phi^{-1}t) = \phi^{-1} \lambda\gamma (\phi^{-1}t)^{\gamma-1} = \phi^{-\gamma} \lambda\gamma t^{\gamma-1}$$

and its survivor function can be represented as

$$S_{Field}(t) = \exp\left(-\int_0^t h_{Field}(u) du\right) = \exp\left(-\int_0^t \phi^{-\gamma} \lambda\gamma u^{\gamma-1} du\right) = \exp(-\lambda\phi^{-\gamma} t^{\gamma})$$

which is a Weibull function with scale parameter $\lambda\phi^{-\gamma}$ and shape parameter γ .

Therefore, if the stiffness deterioration processes of asphalt concrete both in the field and in the laboratory are following the Weibull function when subjected to the same test conditions (excluding test setup), then according to the Weibull accelerated failure time model, $\phi > 1$ will slow down the deterioration process while $0 < \phi < 1$ will accelerate it.

Figure 5.14 illustrates why $0 < \phi < 1$ speeds up the deterioration process and $\phi > 1$ slows it. If $\phi = 1$ is taken as a standard curve and termed “standard ϕ curve”, then for the $\phi = 2$

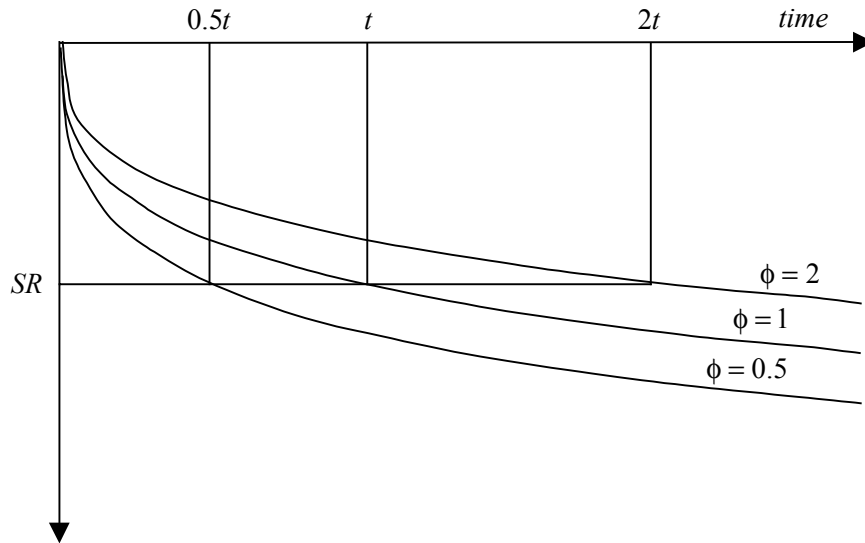

Figure 5.14. Weibull accelerated failure time model with different correction factors.

curve, at any given SR value, the survival time is twice that of the standard ϕ curve; namely, if $\phi = 2$, the fatigue life will be twice that of standard ϕ curve.

What the value of ϕ will be for one field section is going to be verified in the next paragraphs using the back-calculation moduli from MDD data of Section 503RF and the fatigue test results of 503RF (field-mixed and field-compacted).

5.7.3 Demonstration Example

Herein is an example to demonstrate how the ϕ is assessed and a discussion of the associated details will follow. The step-by-step procedures to assess ϕ are shown below:

1. Back-calculate moduli using MDD data,
2. Fit a Weibull function,
3. Find the laboratory Weibull function, and
4. Assess the ϕ value.

5.7.3.1 *Back-Calculation of Layer Moduli for Section 503RF*

This demonstration example will illustrate a procedure to find the shift factor ϕ caused by the different boundary conditions. Figure 5.15 represents the back-calculation results of Section 503RF of the CAL/APT project trafficked using a Heavy Vehicle Simulator (HVS). The section was subjected to a dual wheel load of 40 kN for the first 150,000 repetitions to prevent excessive deformation of the newly constructed asphalt concrete. The repetitions from 150,000 to 200,000 were applied with an 80-kN dual wheel load. After 200,000 repetitions, the trafficking load was increased to and maintained at 100 kN. It should be noted that the equivalent loading frequency obtained is about 0.075 Hz, which is far less than the loading frequency of 10 Hz utilized in laboratory testing. For more information about the test program of Section 503RF, please refer to the “CAL/APT Program: Test Results from Accelerated Pavement Testing on Pavement Structure Containing Aggregate Base-Section 503RF” (Harvey et al. 1997).

The first 200,000 repetitions yielded very little damage; thus, this demonstration example will consider the 200,000 repetition mark as its starting point. To know the stiffness deterioration in the field, the MDD data was collected and analyzed. The methodology of back-calculation used here is based on a Microsoft EXCEL spreadsheet developed by Per Ullidtz (1999). The essence of this spreadsheet is mainly based on Odemark’s method (Ullidtz 1987) and the minimization of the residual sum of squares, i.e., the sum of squares of the difference between observed deformation and calculated deformation.

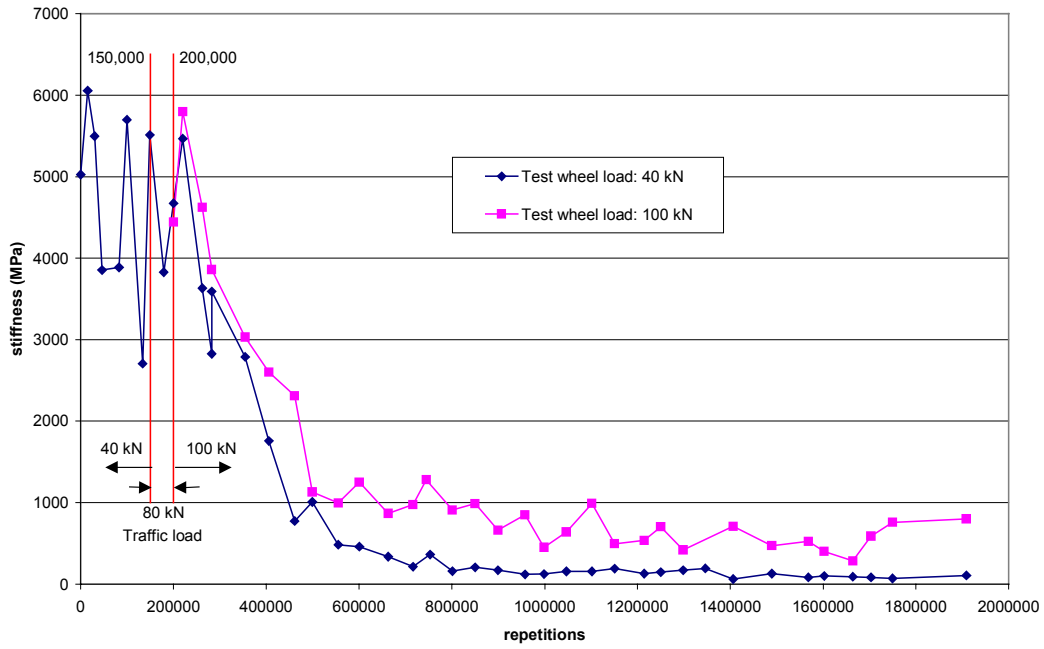

(a)

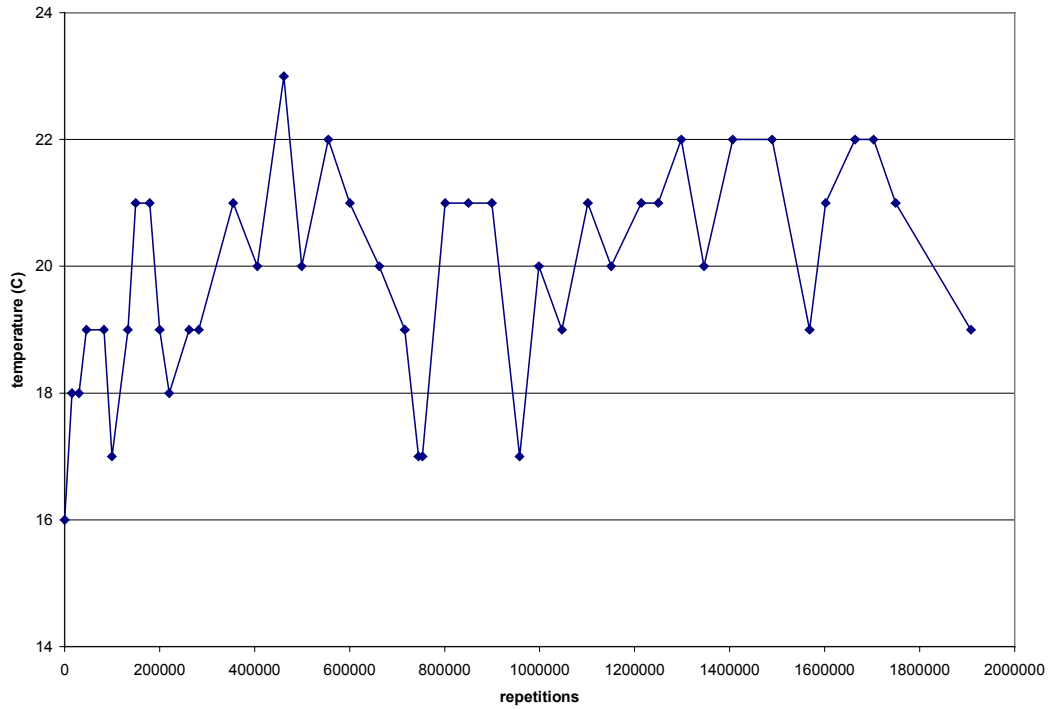

(b)

Figure 5.15. Back-calculated moduli of CAL/APT Goal 1 Section 503RF with test wheel loads of 40 kN and 100 kN subjected to a test temperature of $20 \pm 3^\circ\text{C}$.

It should be noted that though the trafficking load was maintained at 100 kN after 200,000 repetitions, a 40-kN and a 100-kN wheel load were used to measure deflections during data acquisition.

In Figure 5.15, two stiffness deterioration curves are calculated, one using deflections under the 40- kN wheel load, and the other using deflections under a 100-kN wheel load. Clearly, the 100-kN curve shows less stiffness deterioration than that of the 40-kN curve. It is conjectured that the 100-kN wheel load may have caused a higher confining pressure in the base and thus increased the stiffness of the asphalt concrete. However, as an example, the stiffness deterioration curve measured with 40-kN wheel load deflections will be adapted here for the following discussion.

It should be noted that the strain level occurring at the bottom of the asphalt concrete in Section 503RF varies during fatigue loading as stiffness decreases. In other words, according to the Weibull theory, the stiffness deterioration curve in Section 503RF is a fatigue damage curve consisting of several simple Weibull curves, resulting from laboratory controlled-strain tests at different strain levels but all at the same test temperature. Namely, it is not the laboratory controlled-strain fatigue test curve at 20°C. However, for simplicity, assume the stiffness deterioration curve in the field follows a Weibull function under constant strain. The fitted Weibull function thus obtained is illustrated in Figure 5.16 and has the equation:

$$\ln(-\ln(SR_{Field})) = -7.7391 + 0.6563 \ln(rep)$$

where rep = the repetitions of traffic loading.

5.7.3.2 Correction Factor and Laboratory Fatigue Test Results for Section 503RF

A field-mixed and field-compacted beam with a 3.4 percent air-void content tested at

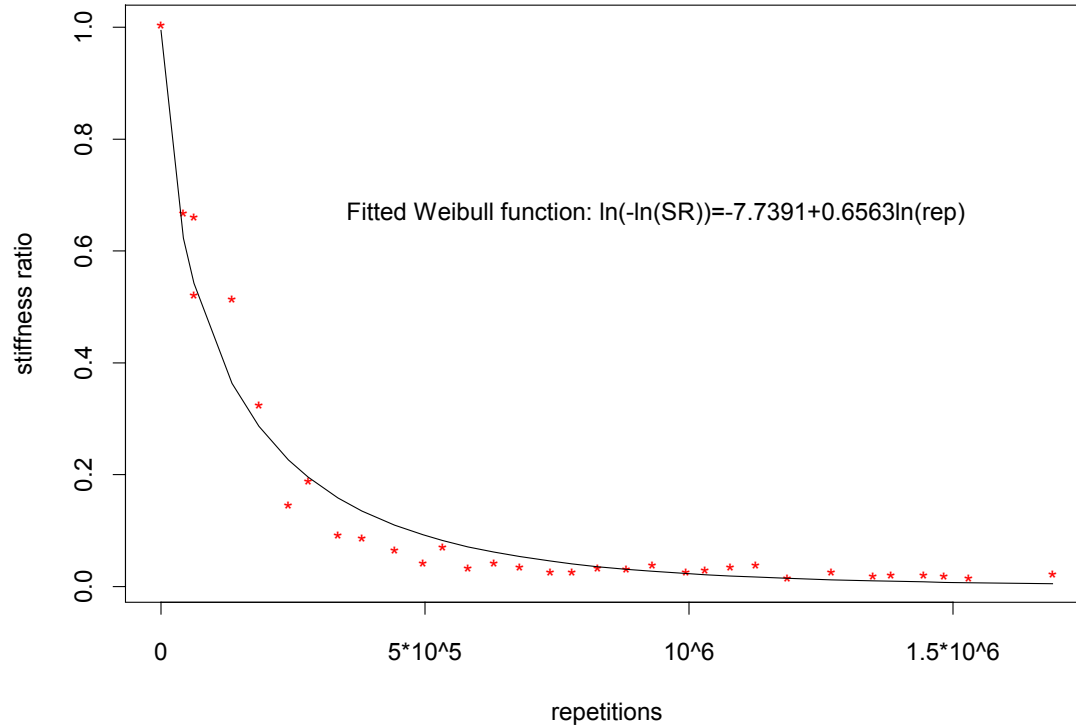

Figure 5.16. Fitted Weibull equation of back-calculated moduli of Section 503RF with a 40-kN test wheel load.

20°C at a 200 microstrain level with a loading frequency of 10 Hz will be utilized as the comparison laboratory Weibull curve. The laboratory Weibull function obtained is

$$\ln(-\ln(SR_{Lab})) = -8.3312 + 0.6178\ln(rep)$$

From the Weibull accelerated failure time model, it is known that

$$S_{Lab}(t) = \exp(-\lambda t^\gamma)$$

and

$$S_{Field}(t) = \exp(-\lambda \phi^{-\gamma} t^\gamma)$$

Taking the logarithm, multiplying by -1, and taking the logarithm again,

$$\ln(-\ln(SR_{Lab})) = \ln \lambda + \gamma \ln t$$

and

$$\ln(-\ln(SR_{Field})) = \ln \lambda - \gamma \ln \phi + \gamma \ln t$$

It should be noted that the shape parameter γ in this Weibull accelerated failure time model is kept the same for both laboratory and field Weibull functions.

Taking the average value of shape parameters, you then have $\gamma = 0.6371$. According to the Weibull accelerated failure time model,

$$-8.3312 - 0.6371 \ln \phi = -7.7391 \quad \Rightarrow \quad \phi = 0.395$$

The ϕ , which is less than one, indicates that the fatigue damage rate for the HVS site is far quicker than that of the laboratory fatigue test.

5.7.4 Mode Factor and Controlled-Strain Fatigue Test

Monismith and Deacon (1969) proposed a definition of mode of loading to describe the phenomenon. “Damaging fatigue loading has been found to gradually alter the strength and stiffness properties of asphalt paving mixes... in which stress and strain levels are permitted to vary during fatigue loading, that is, the mode of loading.” The form is defined as follows:

$$MF = \frac{|A| - |B|}{|A| + |B|} \quad (5.5)$$

where

- MF = mode factor,
- A = percentage change in stress due to a stiffness decrease of C ,
- B = percentage change in strain due to a stiffness decrease of C , and
- C = an arbitrary but fixed percentage reduction in mix stiffness.

Apparently, MF equals -1 for controlled-stress tests and 1 for controlled-strain tests. Any values lying between -1 and 1 represent the intermediate modes. And, most of the time, asphalt concrete pavements in the field will behave like the intermediate mode to different

degrees depending upon support conditions, thickness of the asphalt concrete, temperature, and other factors.

An alternative form of the definition of mode of loading can be represented in terms of MF as shown in the following:

$$\frac{|A|}{|B|} = \frac{1+MF}{1-MF}$$

The ratio of $|A|/|B|$ indicates the ratio of percentage change in stress to the percentage change in strain due to a fixed percentage reduction in stiffness. If the ratio is greater than 1, then, for a fixed percentage decrease in stiffness, the percentage change in stress is higher than the percentage change in strain. In other words, the mode of loading is close to the strain-controlled test. Figure 5.17 plots the $|A|/|B|$ ratios versus the values of MF. As illustrated,

$\frac{|A|}{|B|} > 1$, if $0 < MF \leq 1$; $0 < \frac{|A|}{|B|} < 1$, if $-1 \leq MF < 0$. The ratio is sharply increased when the

MF is greater than 0.5. This indicates that the percentage change in strain can be neglected as compared with the percentage change in stress.

To further explore the mode factor, the fitted Weibull function obtained from back-calculating the results of MDD data for Section 503RF was utilized to run the Circly program. In this simulation, the fixed percentage stiffness change was set to be 5 percent, which is the C in Equation 5.5. Thus, for every 5 percent change in stiffness, the stress and strain calculated from the Circly program will be utilized to compute the mode factor. The initial stiffness of asphalt concrete was set as 5,467 MPa. The pavement structure used in the simulation is listed in Table 5.2.

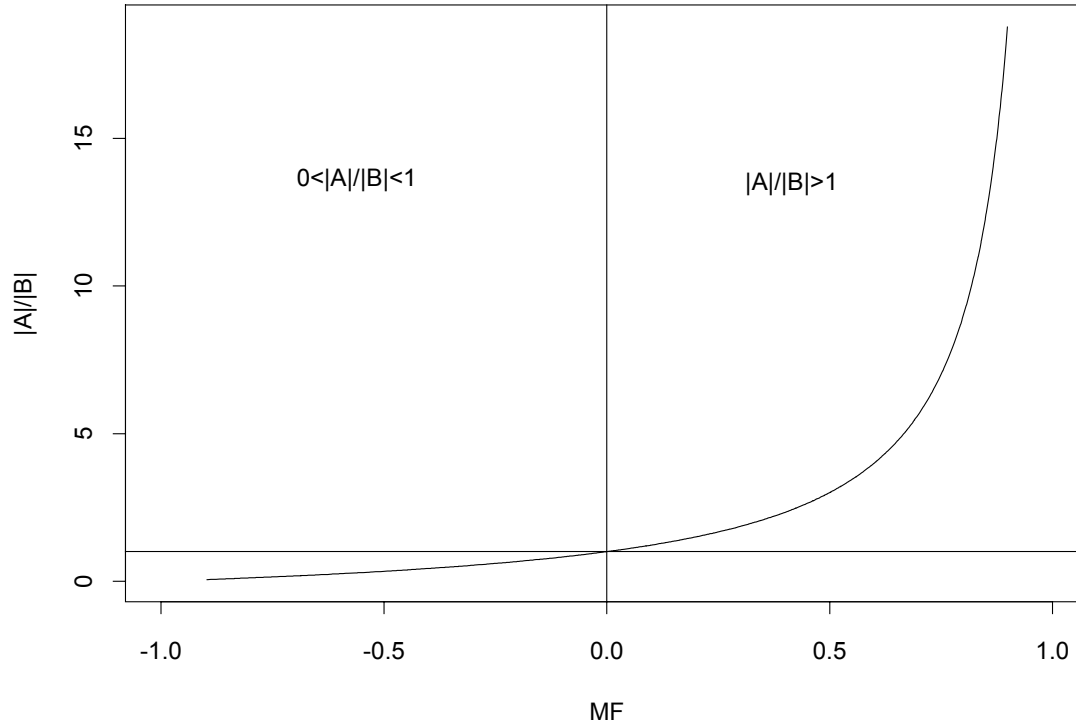

Figure 5.17. Relationship of $|A|/|B|$ ratio versus MF.

Table 5.2 Pavement Structure for Mode Factor Simulation

	Thickness (mm)	Stiffness (MPa)	Poisson ratio
Asphalt concrete	162	Variable	0.35
Aggregate base	274	300	0.35
Aggregate subbase	305	150	0.35
subgrade	Semi-infinite	70	0.45

The top and bottom lifts of one two-lift asphalt concrete layer in Section 503RF are treated as one integrated layer here. The stiffness values are based on the fitted Weibull function. Figure 5.18 shows the history of maximum tensile strains at the bottom of the asphalt concrete layer of Section 503RF utilizing the Circlly program; the tensile strain increases as the stiffness decreases and behaves like an exponential function. The tensile strains ranges from 100 to 300 microstrain. The average tensile strain is about 180 microstrain, which is close to the 200

microstrain laboratory fatigue test utilized in finding the correction factor for boundary condition effect as demonstrated in Chapter 5.7.3.2.

The mode factors calculated for this simulation are plotted in Figure 5.19. Note that the starting point of this figure is moved to the repetition at which the 100-kN test wheel load starts to traffic because the damage caused by loads less than 100 kN is fairly limited. It shows that the MF is a little less than zero at the beginning and grows linearly as the stiffness decreases. Hence, in the sense of mode of loading, at first it is between a controlled-strain and a controlled-stress type, but most of time it exhibits a gradual tendency towards the controlled-strain type.

Two observations can be made from Figure 5.19: (1) when stiffness reaches a 50 percent reduction, the MF is about 0.13 and the $|A|/|B|$ ratio is around 1.3; (2) when MF equals 0.5, the stiffness ratio is about 0.2 and $|A|/|B|$ ratio is about 3.0.

It seems that the Weibull proportional hazards model obtained from the controlled-strain fatigue test is quite reasonable and acceptable to apply in explaining real field performance in comparison to the back-calculation results of layer moduli of 503RF data.

5.7.5 Findings and Discussions

From the above Weibull accelerated failure time model and the demonstration example, it seems that the controlled-strain fatigue test is a fair test to explain the phenomenon of the fatigue damage process. However, several restrictions cannot be discounted in this discussion of the Weibull accelerated failure time model. These restrictions are:

1. Using the Circly program, which is a linear layered-elastic program, cannot completely describe the viscoelastic properties of asphalt concrete, especially at high temperatures.

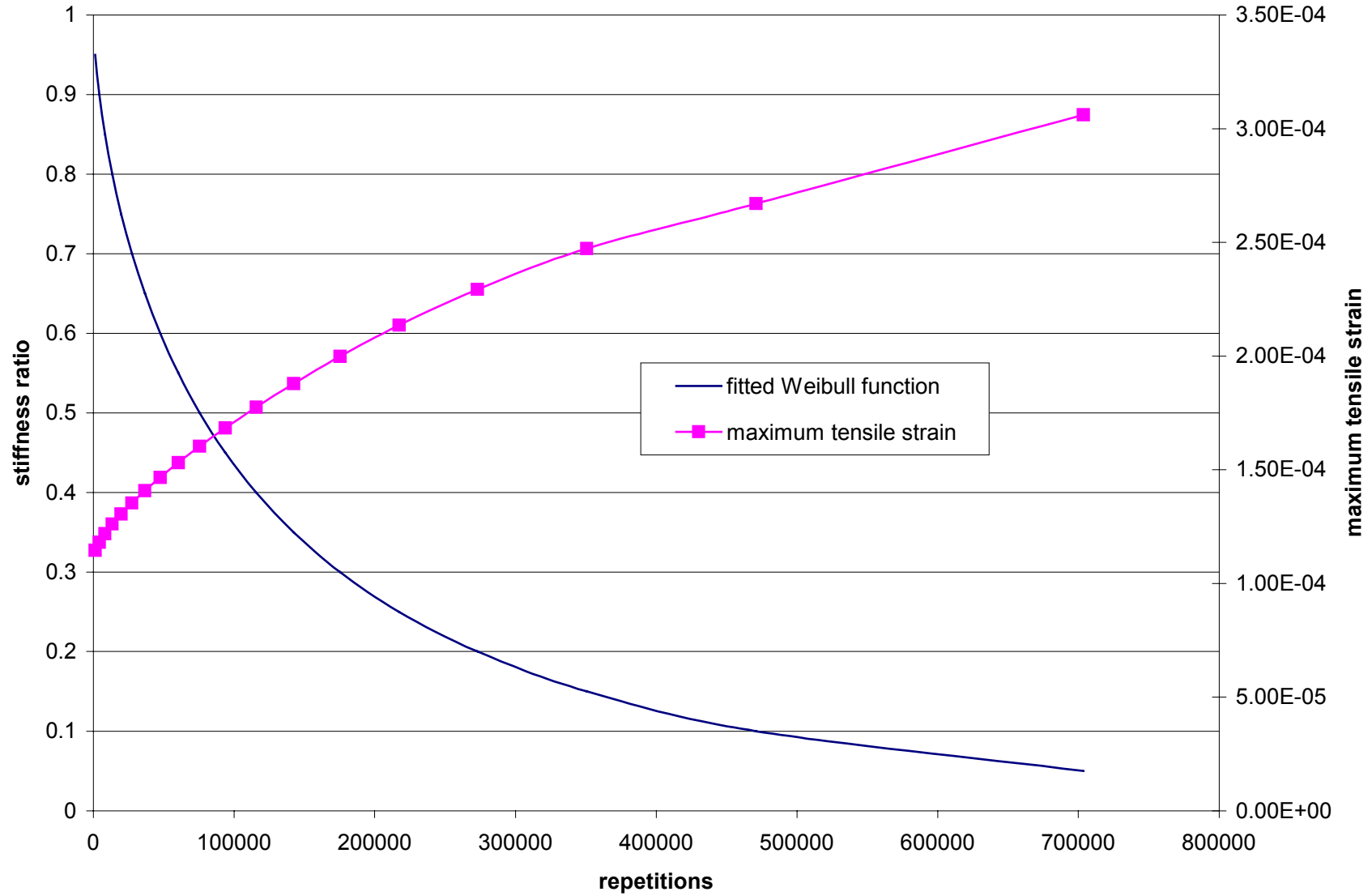

Figure 5.18. History of maximum tensile strain of Section 503RF.

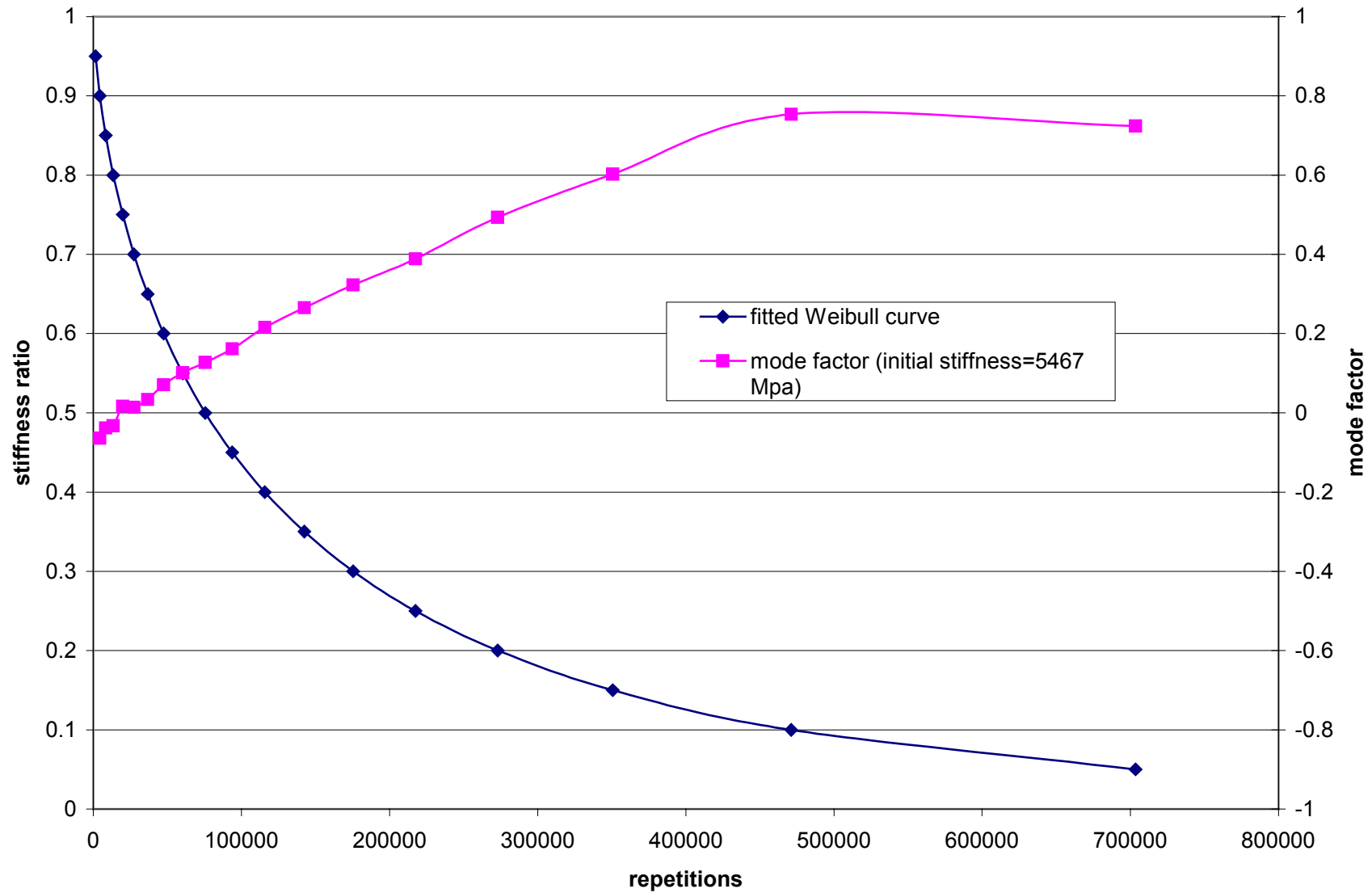

Figure 5.19. History of mode factor of Section 503RF.

2. Although Section 503RF is well controlled in both environmental and traffic test conditions, this still cannot overcome the intrinsic fact that stiffness deterioration due to fatigue loading will alter the strain levels, therefore making it problematic to compare laboratory fatigue test data and field performance data, even when both are subjected to the same test conditions.
3. The back-calculation methodology as it now stands is somewhat questionable. The current method seems to introduce considerable variance even if the accuracy of MDD instrumentation is ensured.
4. The wheel speed of the HVS is about 6 miles/hour (mph) and the travel distance of the test wheels is about 6 meters effective length. Thus, the loading frequency is about 0.075 Hz, far slower than that of the laboratory fatigue testing.

Although several unavoidable constraints on the accuracy are inherent in this type of analysis, numerous findings are still worthy of mention, notably

1. The results of the demonstration example indicate that the stiffness deterioration rate of the field ($\phi \cong 0.4$) is about two and a half times faster than that of laboratory tested samples ($\phi = 1.0$). The 200 microstrain level used in laboratory testing is roughly compatible with the 180 average microstrain calculated from the Circly simulation, which has been discussed in Chapter 5.7.4. The test temperature utilized both in the laboratory and at the HVS site is 20°C. The major deviance is in the loading frequency: 10 Hz in laboratory, whereas a very slow frequency 0.075 Hz was used in the field. It is conjectured that the slow loading frequency of the HVS could impart more energy per repetition and thus result in more damage.

2. Instead of maintaining constant tensile strain level, the maximum tensile strain, which occurred at the bottom of the asphalt concrete layer, increases as the load repetitions increase.
3. The deterioration process will increase the tensile strain level at the bottom of the asphalt concrete layer. According to the Weibull theory, the stiffness deterioration process is actually a combined Weibull curve that consists of several simple Weibull curves with different strain levels at the same test temperature. Therefore, it is hard to find out the exact value ϕ in this calculation; in other words, the ϕ should be time-dependent.
4. The inherent properties of the controlled-stress fatigue test will display an infinite strain level if there is no physical limit or constraint of material. This phenomenon contradicts the situation in the field where the asphalt concrete layer is supported by the structure underneath and its deformation is thus partly controlled by it, which restricts the possibility of developing infinite strain. According to the definition of mode factor and the results of simulations, it is certainly reasonable to utilize the results of controlled-strain flexural fatigue tests to predict performance in the field. And, it worked well for a pavement that had an asphalt concrete layer of 150 mm (relatively thick).
5. A better way of assessing the ϕ value is to conduct a trial-and-error iteration method. First, construct the Weibull proportional hazards model using laboratory fatigue tests with the same mix. Then, assume a ϕ value and use this value to modify the Weibull proportional hazards model. After this, follow the algorithm described previously to construct the stiffness deterioration curve and then compare the curve obtained from

back-calculation. If it does not match with the field performance, then change the ϕ value and redo it until they converge. With the aid of an effective modulus back-calculation methodology and the Weibull dynamic approach, the iteration procedure to find the ϕ will be useful for research purposes and provide understanding of shift factors for field real pavement design.

It should be conjectured that this analysis might have given better performance prediction if the finite element program was engaged, for the fatigue damage function is still needed to provide a specified input for finite element program. The accuracy of the finite element method (FEM) to calculate the stress and strain will be eliminated if an inadequate fatigue damage function is utilized. Actually, the change of combination status of the stress and strain is the major property and index to reflect fatigue damage in field pavement. The laboratory controlled-strain fatigue test is adapted for the explanation of fatigue damage because it is easy to control and perform in the laboratory; in other words, neither a controlled-stress nor a controlled-strain fatigue test can completely describe the fatigue damage behavior of asphalt concrete. As mentioned before, ideally, simple and economical tests are used to identify the fatigue damage behavior and thus bridge the result to fatigue performance in the field. Hence, utilizing the controlled-strain fatigue test to describe the fatigue damage in the field requires, as expected, some corrections in order to predict the real performance. The debut of the Weibull accelerated failure time model can serve the purpose of determining the correction factor caused by boundary condition effect. However, a more extensive database of real pavement performance should be created so as to supplement further studies and verify the feasibility of the Weibull accelerated failure time model.

6.0 WESTRACK SIMULATION USING MINER'S LAW

6.1 Introduction

The ultimate objective of laboratory tests of asphalt concrete is to economically predict and explain the performance of asphalt concrete in the field. This chapter explains the use of fatigue test results from a laboratory test program to construct a fatigue performance prediction approach using Miner's Law and compares the simulation results with the condition survey data defining fatigue performance in the WesTrack test pavements. The fatigue simulation methodology focuses on the occurrence of crack initiation at the bottom of the asphalt concrete layer, the location at which cracking was observed to start in the WesTrack pavements.

The laboratory fatigue test results to define fatigue failure are based on the 50 percent stiffness reduction that is assumed to be approximately representative of crack initiation. To develop a crack propagation model, a deliberate and advanced test method or algorithm is needed to clearly define the crack propagation phenomenon occurring in the asphalt concrete and is beyond the scope of this investigation. A different approach, based on the Weibull model and including the study of high temperature fatigue, is postulated in the Chapter 7.

The recording and analysis periods of WesTrack are summarized in Table 6.1. Temperature data were recorded from 3/3/96 to 10/2/98 on an hourly basis. Collection of traffic data started on 2/3/96, but to comply with the first available temperature data, the traffic data used in the simulation starts on 3/3/96. The last application of traffic loading concluded on 9/3/98. These data were also collected on an hourly basis. Accordingly, the simulation covers the period 3/3/96 to 9/3/98. During the period from 2/3/96 to 3/3/96, traffic loading was negligible as compared with the total applied traffic and thus it is not used in the performance

prediction. The temperature analysis period is extended one month past the traffic recording period to incorporate the total available temperature data.

Table 6.1 Recording and Analysis Periods of WesTrack Project

	from	To
Temperature Recording Period	3/3/96	10/2/98
Traffic Recording Period	2/3/96	9/3/98
Temperature Analysis Period	3/3/96	10/2/98
Simulation Period (both traffic and temperature)	3/3/96	9/3/98

Three basic assumptions are required to apply the procedure herein to the evaluation of pavement fatigue performance. First, it is assumed that the stresses and strains in the real pavement structure can be evaluated by layered-elastic theory. Second, the regression equations for fatigue life obtained from laboratory tests, including temperature as an independent variable, are considered to be valid when the extrapolated bottom temperatures of asphalt concrete are greater than 30°C, which is the upper limit for a conventional fatigue test. Third, when analyzing a dual-tire traffic load such as at WesTrack, the tensile strains calculated by the Circlly program can be regarded as a bi-normal function, that is, the addition of two overlapping normal density functions. More details of the bi-normal function are discussed herein.

A general procedure to predict fatigue performance using Miner’s Law is outlined below. Some terms will be explained in more detail later in this chapter. The simulation procedure can be summarized as follows:

1. Obtain laboratory mechanistic-empirical models for stiffness and fatigue life.
2. Categorize the observed WesTrack temperature data.
3. Run Circlly program to evaluate the maximum principal tensile strain at the underside of the asphalt concrete layer.

4. Conduct regression analysis to represent the tensile strain as a function of the covariates: wander offset, air-void content (av), asphalt content (ac), and the temperature-related group (T_b, g, sg), where T_b is the temperature at the bottom of asphalt layer; g is the temperature gradient; and sg is the subgrade modulus.
5. Run fatigue performance prediction simulation (crack initiation).
 - a. Construct input matrix and find four parameters of strain function
 - b. Compute the tensile strains with offsets
 - c. Determine the fatigue life with offsets
 - d. Construct the repetition matrix
 - e. Evaluate the fatigue damage matrix and apply Miner's Law

Figure 6.1 outlines a flow chart for the simulation procedure. It should be remembered that this simulation methodology is only for the prediction of crack initiation time and not for the prediction of crack propagation time. In sum, the purpose of this simulation procedure is to eliminate the computational effort of layered-elastic programs, especially for calculations on an hourly basis, and replace the determinate solution of tensile strain with one found by a set of statistically analyzed equations. It should be noted that the simulation procedure was conducted using S-PLUS. The simulation program and its corresponding functions written by S-PLUS are listed in Appendix D.

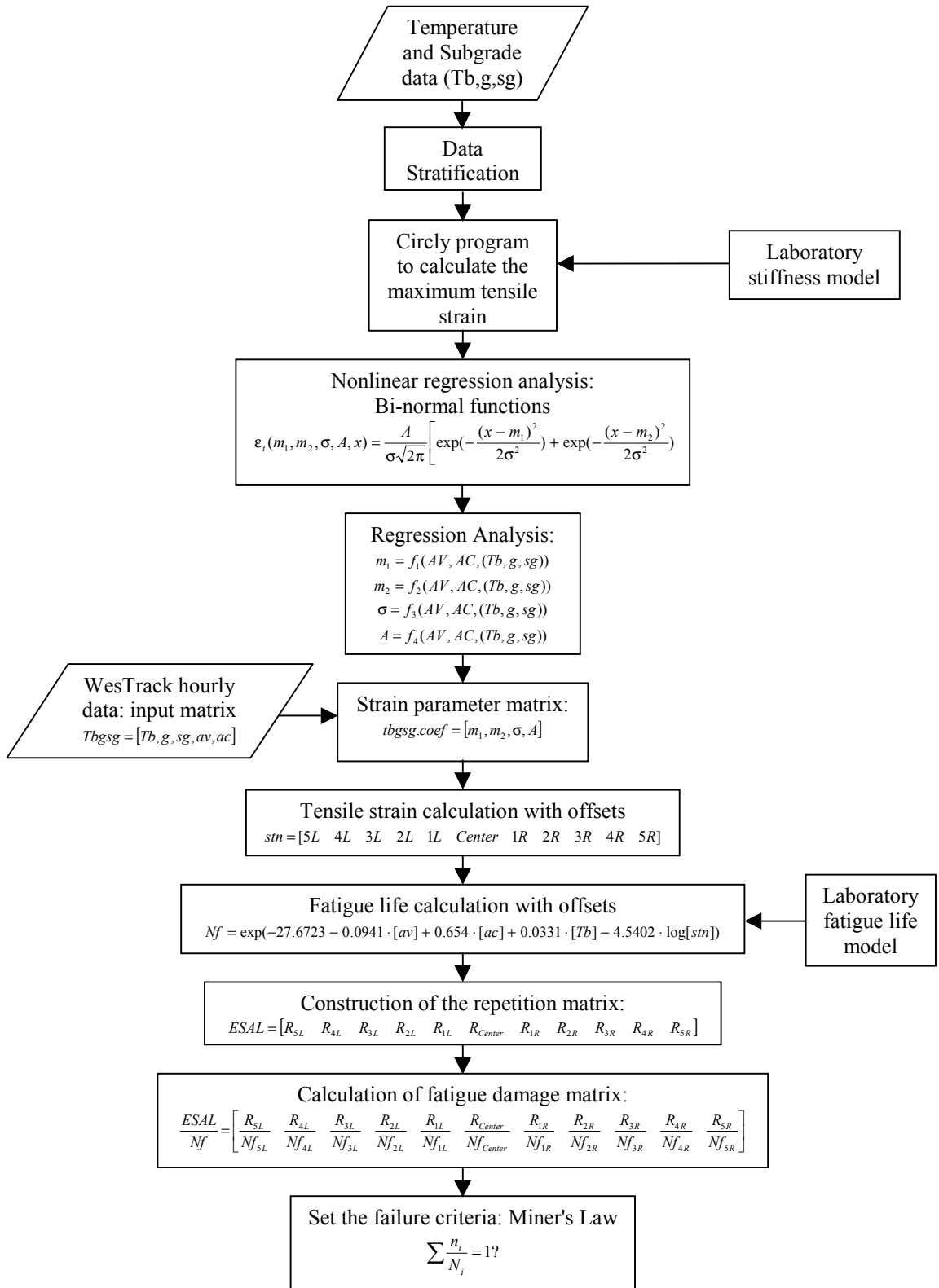

Figure 6.1. Flow chart of the simulation procedure for fatigue performance prediction (crack initiation time).

6.2 WesTrack Data Summary

6.2.1 Temperature Distribution

Figure 6.2 is a time series plot of the WesTrack representative temperatures, at a depth of 50 mm in the asphalt concrete layer, from 3/3/96 to 10/2/98, and exhibits the obvious seasonal and daily variations. The daily bandwidths vary as much as 30°C. The histogram in Figure 6.3 plots the temperature density function, also at a depth of 50 mm. It should be noted that since the histogram is scaled as a probability density, the sum of the bar height and bar width equals one. Shown in this figure are two modes located at temperatures 5°C and 30°C. The resulting shape of the density function looks like two overlapping normal distributions.

Figure 6.4 illustrates the temperature distribution function at a depth of 50 mm in the asphalt concrete layer of WesTrack from 3/3/96 to 10/2/98. Note that this figure shows that the probability of the temperature being greater than 30°C is about 0.25.

The time series plot in Figure 6.5 shows a narrower bandwidth of daily temperature variation at a depth of 150 mm than measured at 50 mm. In the histogram shown in Figure 6.6, the temperature density function at a depth of 150 mm, the two modes are even more pronounced and the temperature spread is narrower than the variance of the density function at a depth of 50 mm, shown in Figure 6.3. In Figure 6.7, the portion of temperatures at this depth greater than 30°C and less than 40°C is about 20 percent of the total recorded time. Therefore, the temperature range of 30°C to 40°C was selected as the key range to study the effect of high temperatures on fatigue in this project.

Figure 6.8 is a time series plot of temperature gradient. Figure 6.9 and Figure 6.10 present the density function and distribution function of temperature gradient of WesTrack from

Secs 12+25: Depth @ 50 mm

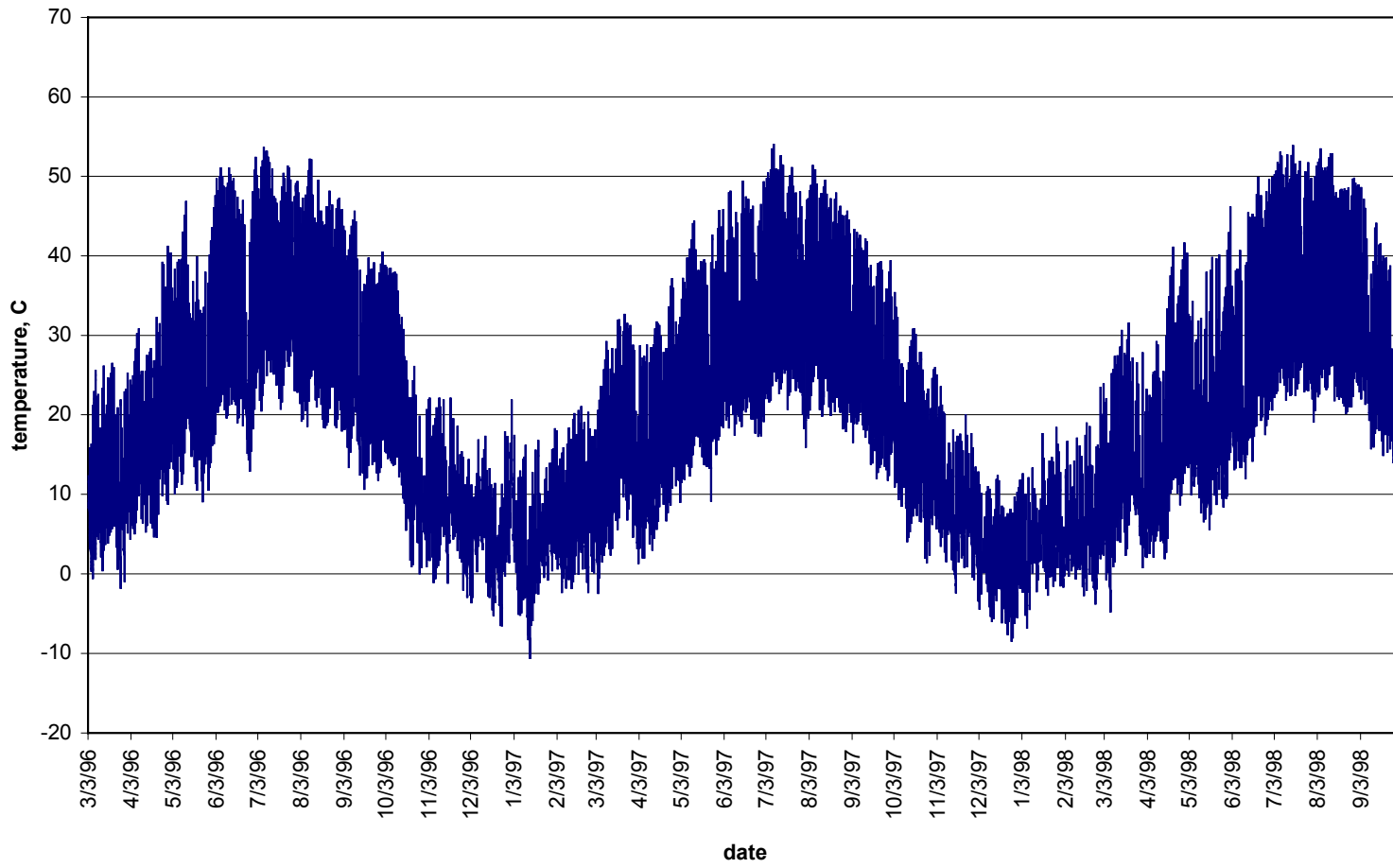

Figure 6.2. Temperature spectrum of WesTrack at a depth of 50 mm from 3/3/96 to 10/2/98.

Temperature Density Function: 50 mm, 3/3/96-10/2/98

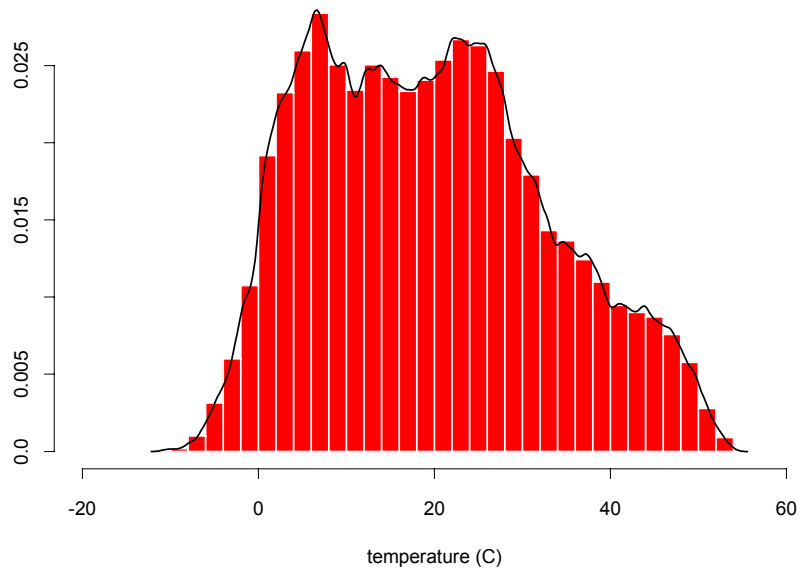

Figure 6.3. Temperature density function of WesTrack at a depth of 50 mm from 3/3/96 to 10/2/98.

Temperature Distribution Function: 50 mm, 3/3/96-10/2/98

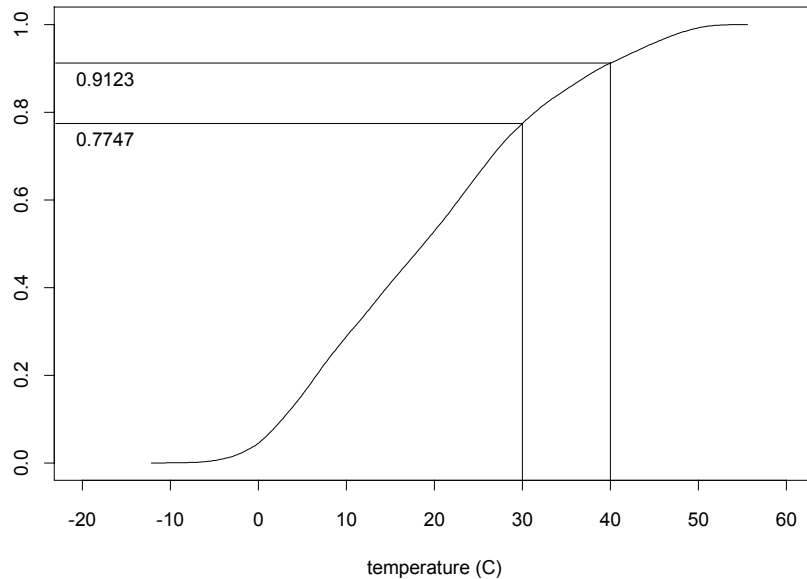

Figure 6.4. Temperature distribution function of WesTrack at a depth of 50 mm from 3/3/96 to 10/2/98.

Secs 12+25: Depth @ 150 mm

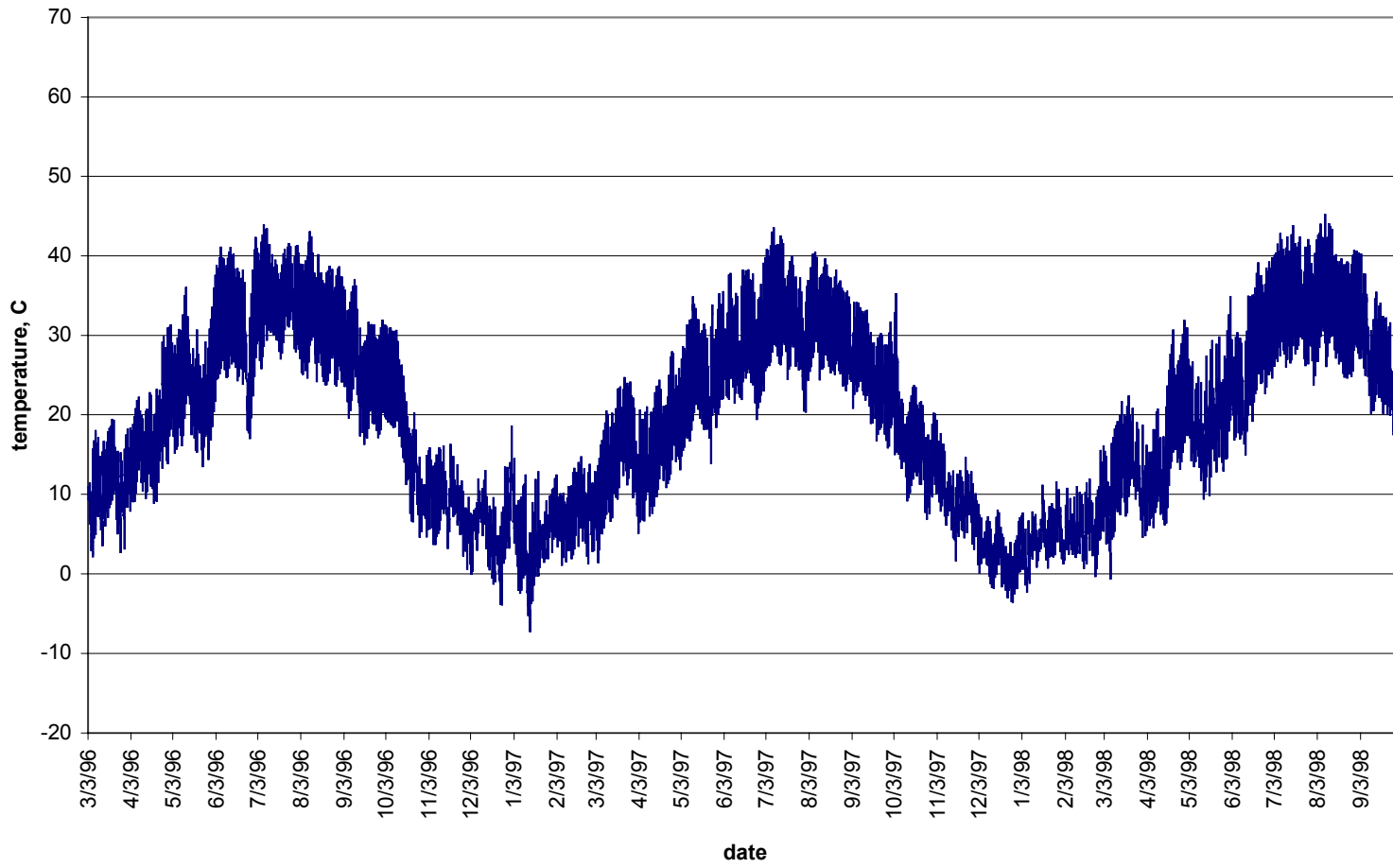

Figure 6.5. Temperature spectrum of WesTrack at a depth of 150 mm from 3/3/96 to 10/2/98.

Temperature Density Function: 150 mm, 3/3/96-10/2/98

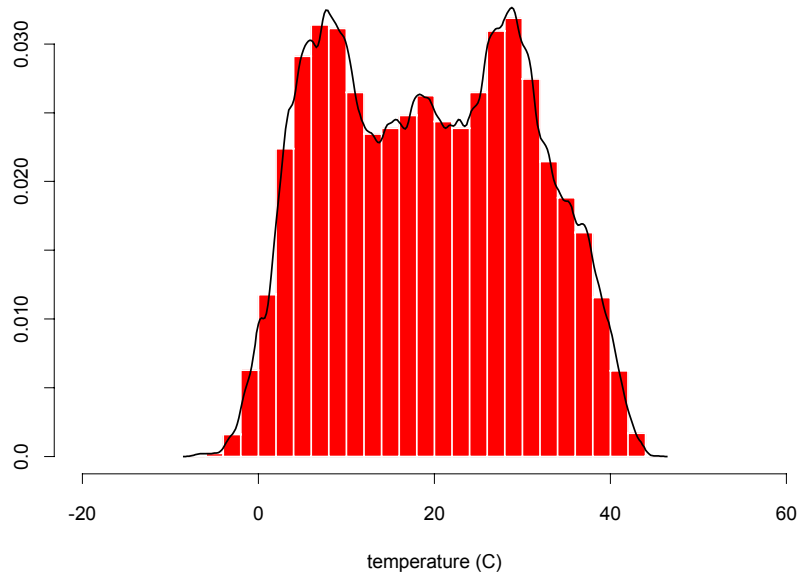

Figure 6.6. Temperature density function of WesTrack at a depth of 150 mm from 3/3/96 to 10/2/98.

Temperature Distribution Function: 150 mm, 3/3/96-10/2/98

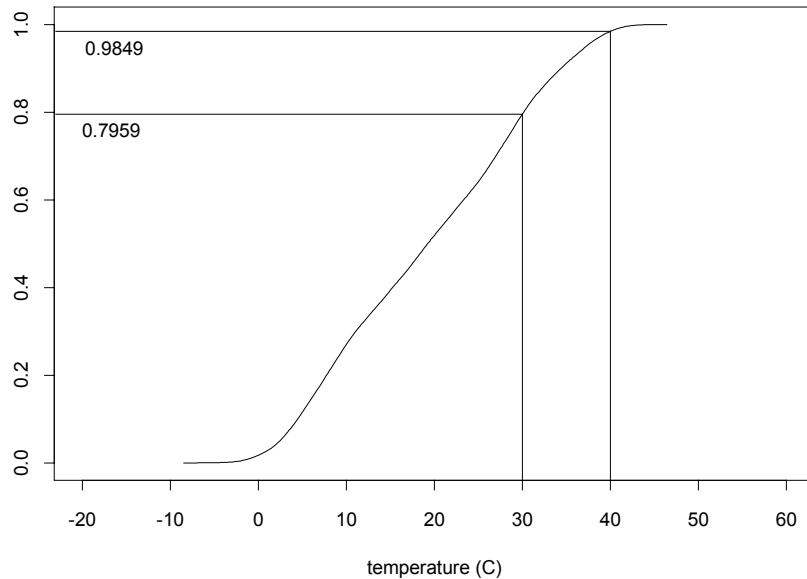

Figure 6.7. Temperature distribution function of WesTrack at a depth of 150 mm from 3/3/96 to 10/2/98.

Secs 12+25: temperature gradient

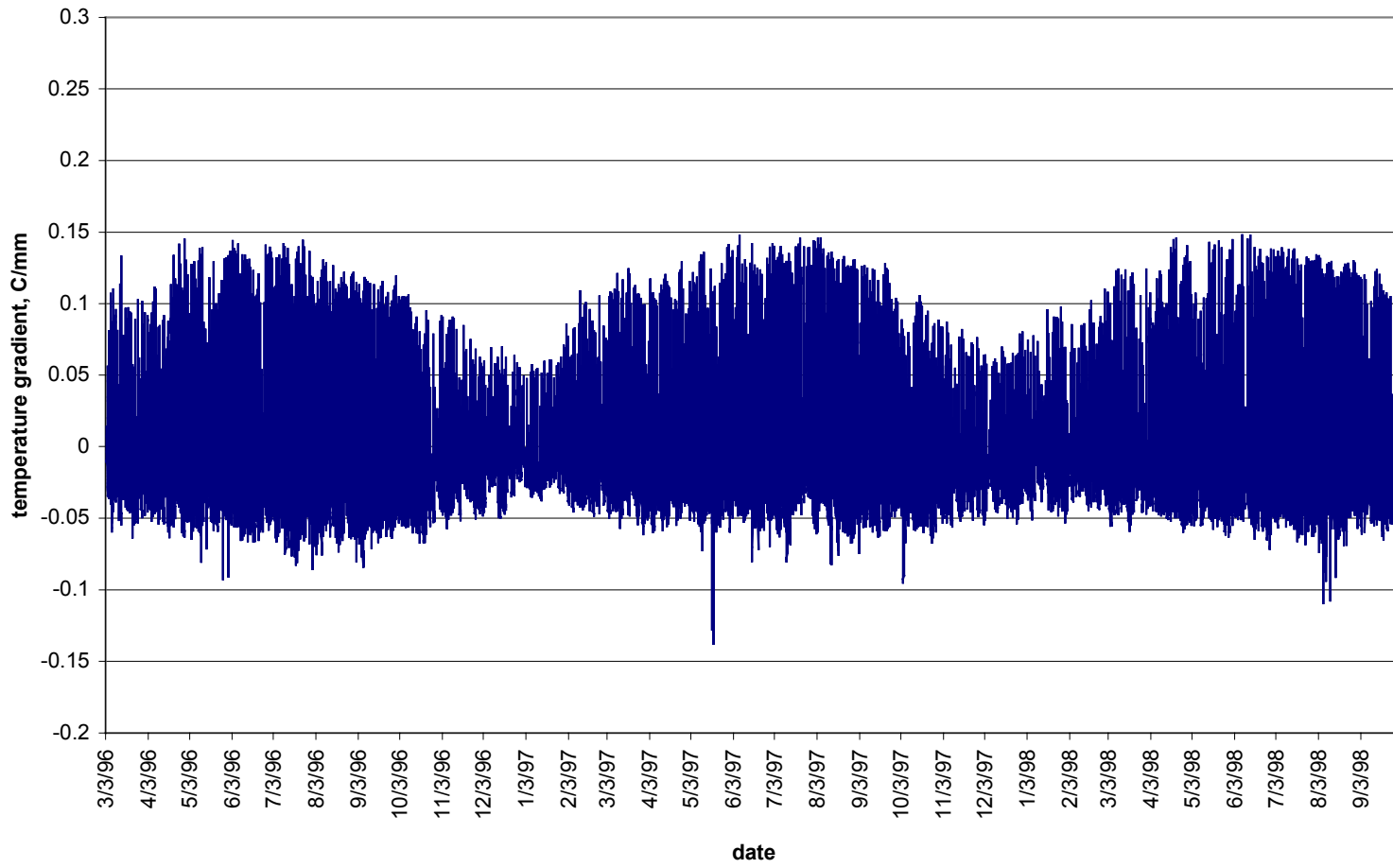

Figure 6.8. Spectrum of temperature gradient at WesTrack from 3/3/96 to 10/2/98.

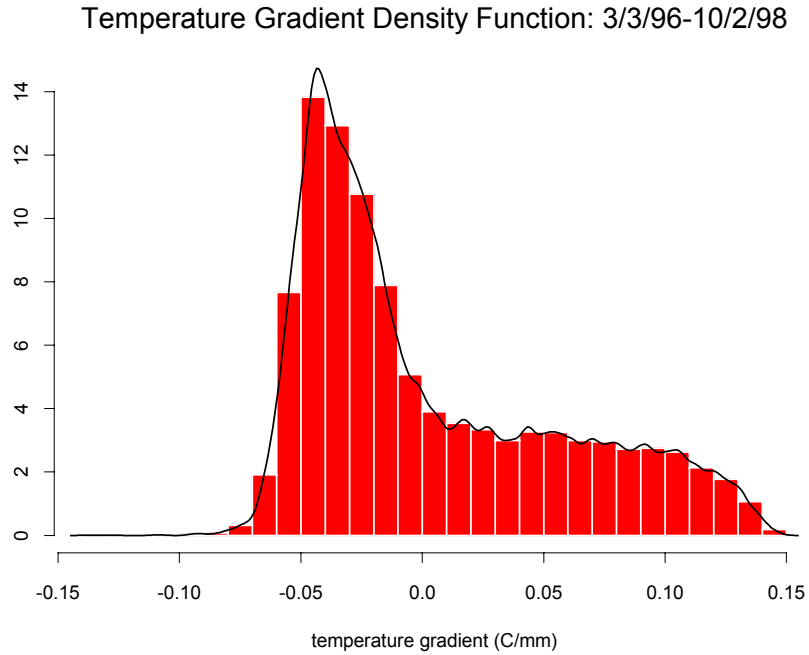

Figure 6.9. Temperature gradient's density function at WesTrack from 3/3/96 to 10/2/98.

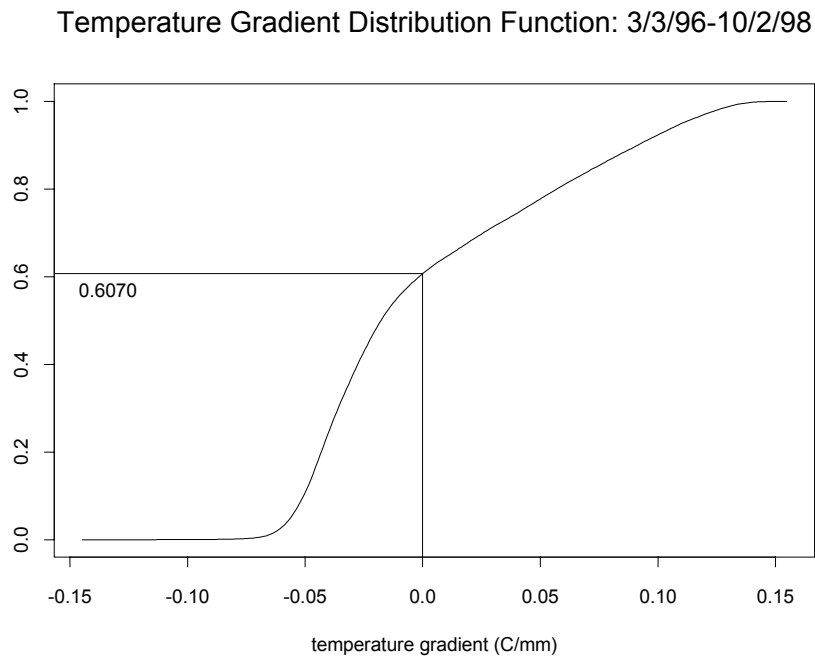

Figure 6.10. Temperature gradient's distribution function at WesTrack from 3/3/96 to 10/2/98.

3/3/96 to 10/2/98. Recall that the temperature gradient is defined as $(T_{50} - T_{150})/100$, where T_{50} is the temperature at 50 mm and T_{150} is that at 150 mm. Hence, the negative gradient means the temperature at the top of asphalt concrete layer is less than the temperature at the bottom of the asphalt concrete layer. In Figure 6.10, most of the negative gradients range from -0.05 to 0 whereas the positive gradients spread from 0 to 0.15 . Those temperature gradients ranging from -0.05 to 0 represent about 60 percent of the total recorded time. Thus the temperature differences of top and bottom range from 0°C to -5°C for 60 percent of time.

6.2.2 Traffic Pattern

A time series plot of cumulative ESALs for various wander locations is shown in Figure 6.11. Because the WesTrack traffic pattern was planned, it does not have a randomly distributed wander pattern as in Figure 6.12, which is an example of typical wheel distribution pattern (Allen 1979). For this reason, four periods were identified to reflect the specific different traffic patterns of WesTrack. The bar charts of Figure 6.13 list these four periods in a time sequence, (a) 3/3/96 to 7/15/96, a period of no wander or human driver, (b) 7/16/96 to 12/14/96, a period of being trafficked at 5R and 5L wander locations only, (c) 12/15/96 to 2/18/97, a period of being trafficked only 135,249 ESALs (about 2.7 percent of total applied ESALs), and (d) 2/19/97 to 9/3/98, a period of varied wander pattern.

Figure 6.14 illustrates a bar chart of the wander distributions throughout the whole simulation period. It is apparent that this bar chart does not match the wander distribution shown in Figure 6.12 which means that traffic wander at WesTrack did not match that of typical field highway pavements. The wander locations at 5R and 5L represent 32 percent of the total applied ESALs.

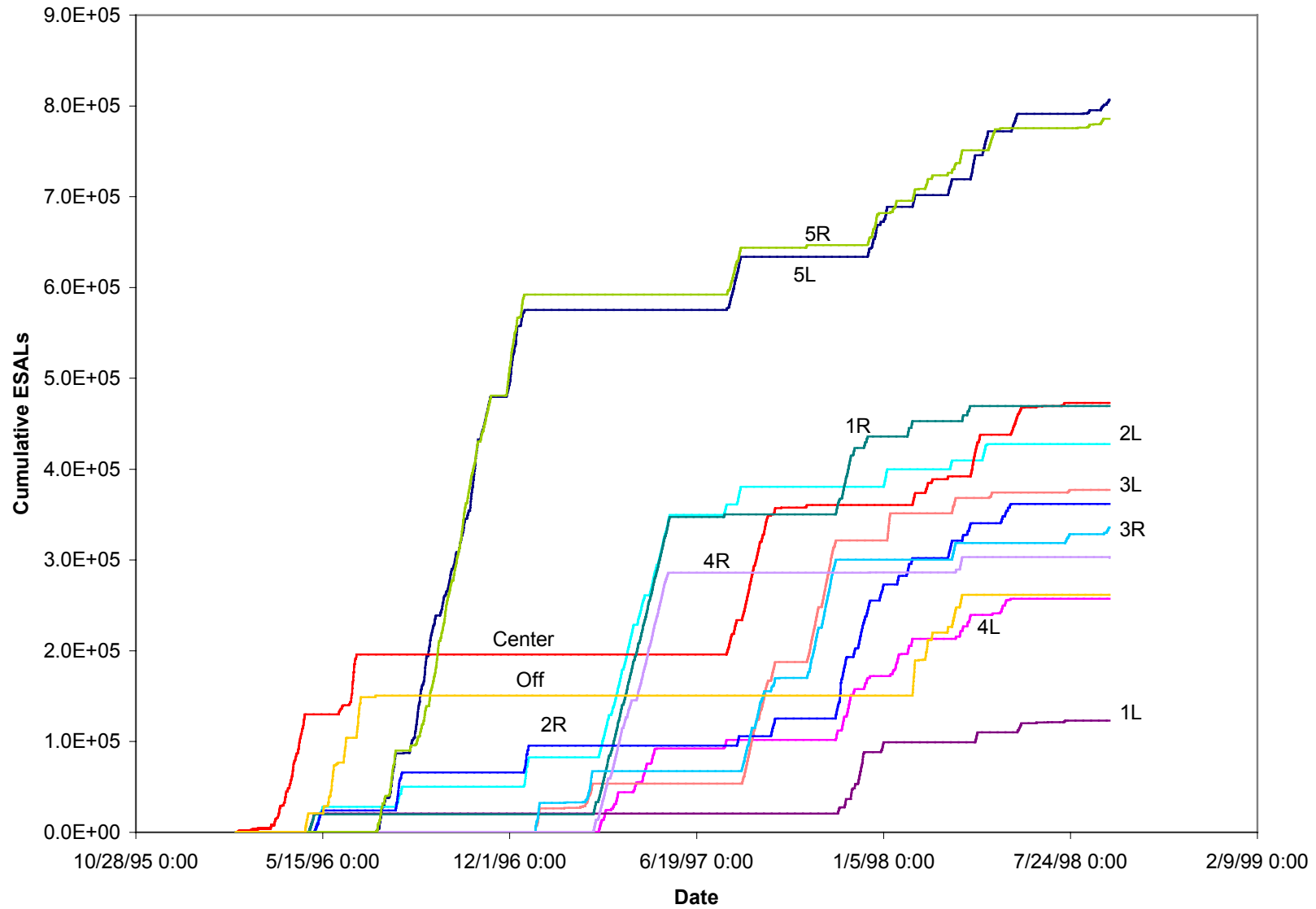

Figure 6.11. Applied traffic at various wander locations of WesTrack.

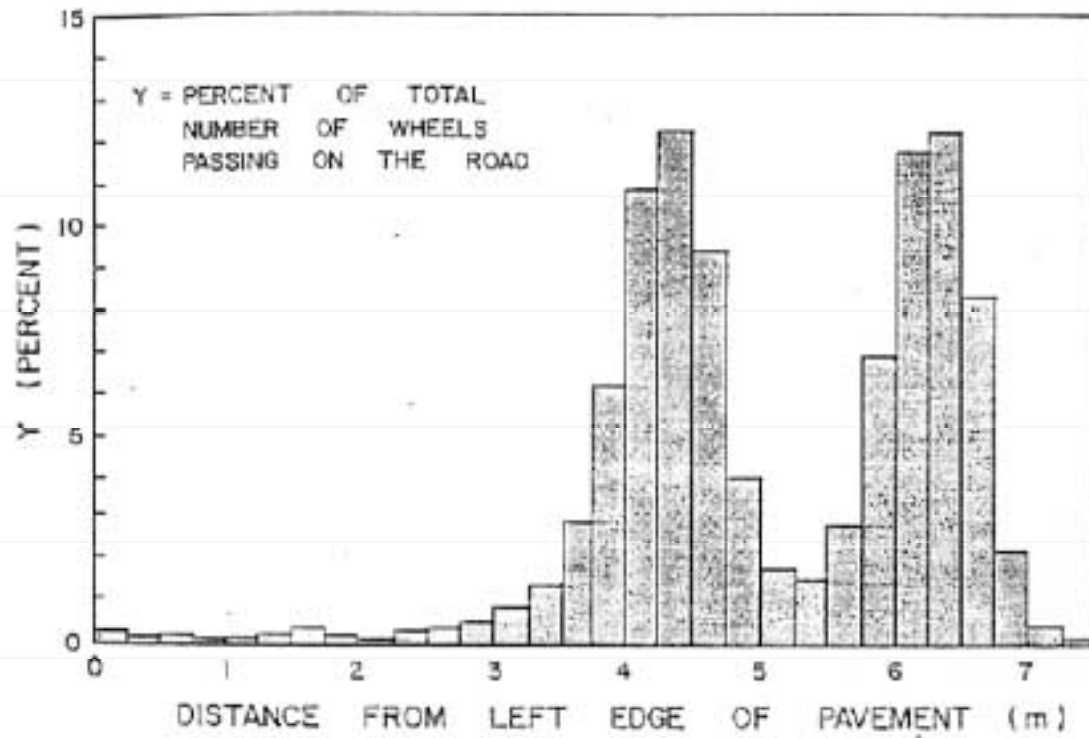

Figure 6.12. Typical highway wander pattern (after Allen).

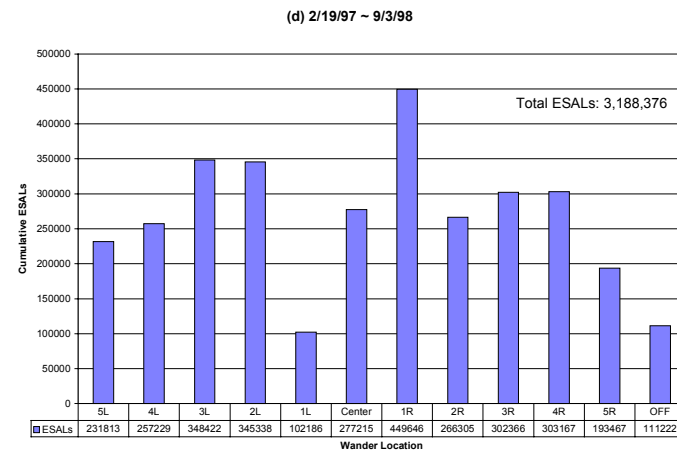
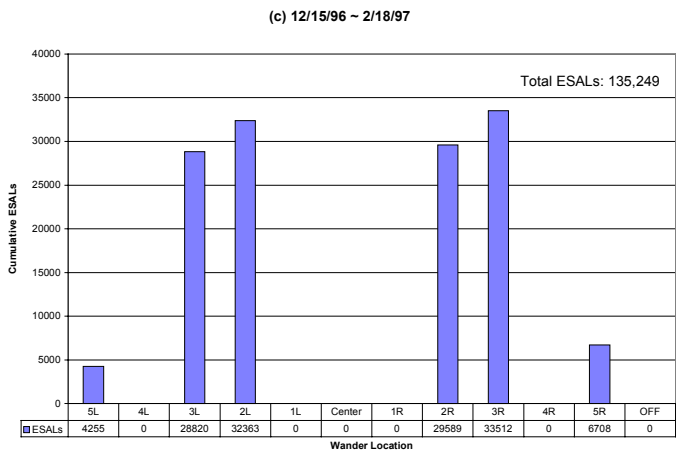
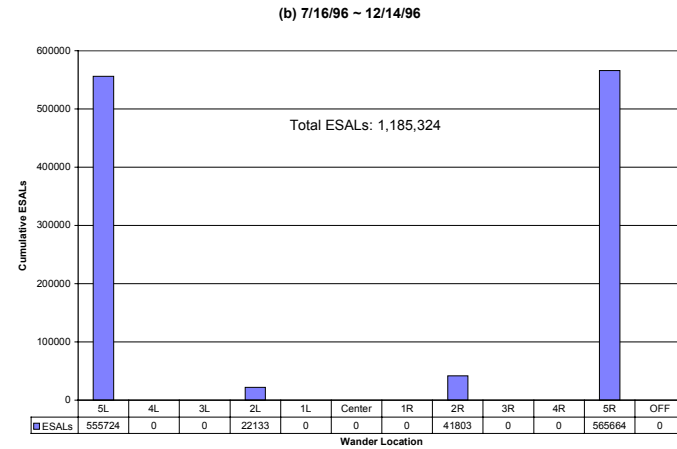
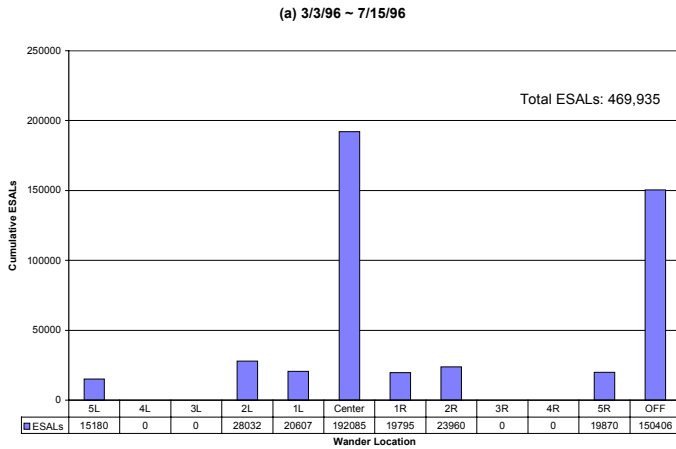

Figure 6.13. Bar charts of applied traffic at various wander locations at different periods of WesTrack: (a) 3/3/96-7/15/96: no wander or antenna off, (b) 7/16/96-12/14/96: traffic only at 5R and 5L, (c) 12/15/96-2/18/97: only 135,249 ESALs applied, and (d) 2/19/97-9/3/98: varied wander pattern.

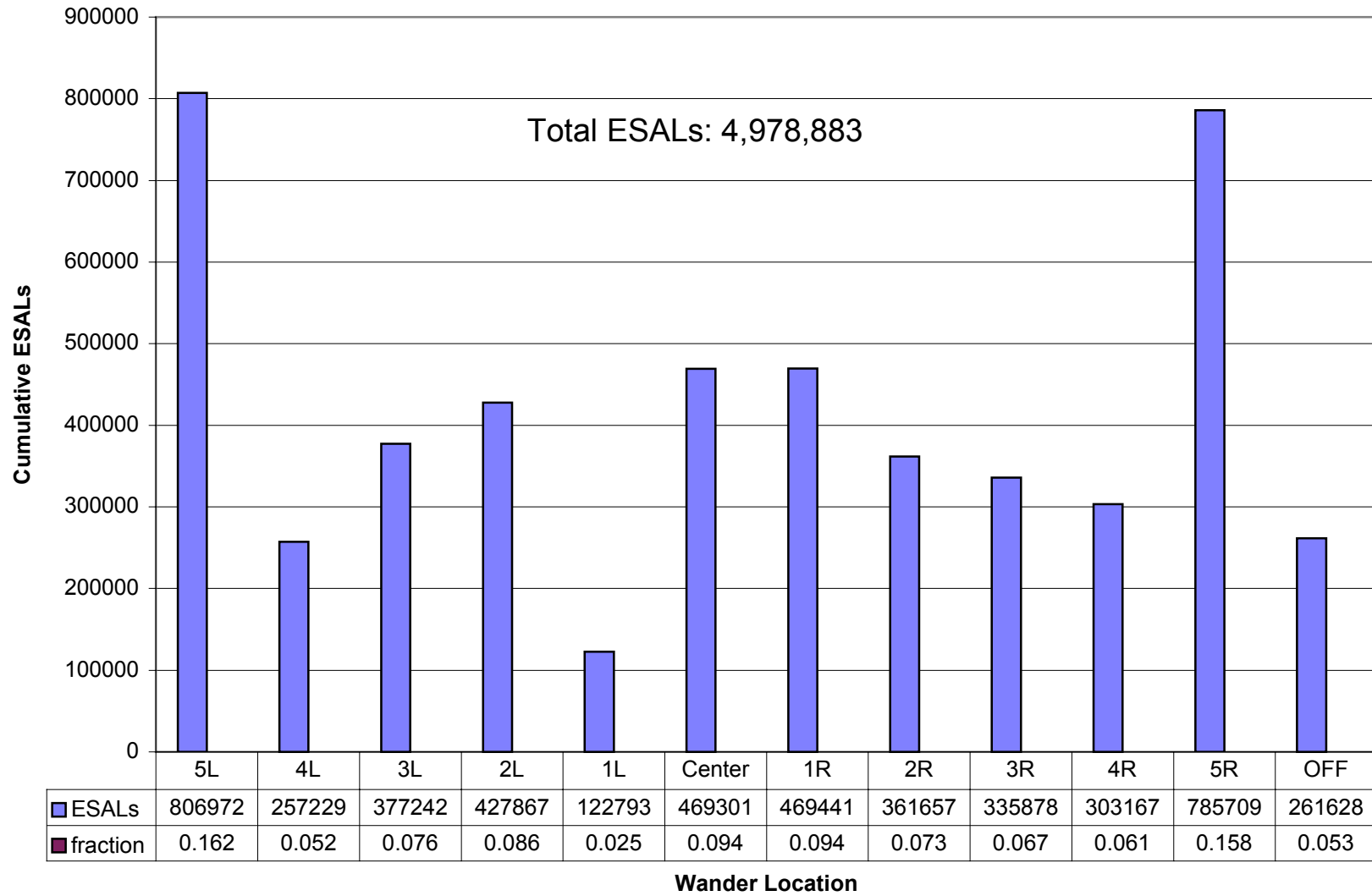

Figure 6.14. Bar chart of applied traffic at various wander locations from 3/3/96-9/3/98.

Figure 6.15 overlaps the temperature spectrum at depth 150 mm and the total cumulative ESALs. The horizontal part of the cumulative ESAL curve represents a period of no applied traffic; the slope of the curve reflects the cumulative rate of applied ESALs—a sharp slope results from intensive applied trafficking load.

6.3 Mechanistic-Empirical Models for Stiffness and Fatigue Life

Recall that the main purpose of this chapter is to present an alternative method for estimating the cumulative fatigue damage of wander and no-wander traffic loading using Miner’s Law. However, Miner’s approach has some inherent drawbacks that cannot be mended by any improvements of the statistical regression models. Therefore, instead of using the regression models of initial stiffness and fatigue life obtained in Chapter 4, the mechanistic-empirical models of stiffness and fatigue life originally developed during the WesTrack project were utilized in the simulation. These models were obtained based on the results of two groups of tests, namely, WesTrack temperature sensitivity fatigue tests and WesTrack fatigue tests at 20°C.

The WesTrack temperature sensitivity fatigue tests were conducted at three temperatures, 5°C, 20°C, and 30°C, and subjected to various strain levels, 200, 400, and 800 microstrain. Table A.4.2 summarizes the test results. The WesTrack fatigue tests at 20°C were conducted at 200 and 400 microstrain levels for each section and the results and associated testing conditions are tabulated in Table A.4.1. A summary of the sample sizes tested in these two groups with three gradations is listed in Table 6.2.

Table 6.2 Sample Sizes of Fatigue Tests for Various Gradations

Gradation	WesTrack fatigue tests at 20°C	WesTrack temperature sensitivity fatigue tests	Total
Fine	48	11	59
Fine-plus	50	12	62
Coarse	53	12	65
Sum	151	35	186

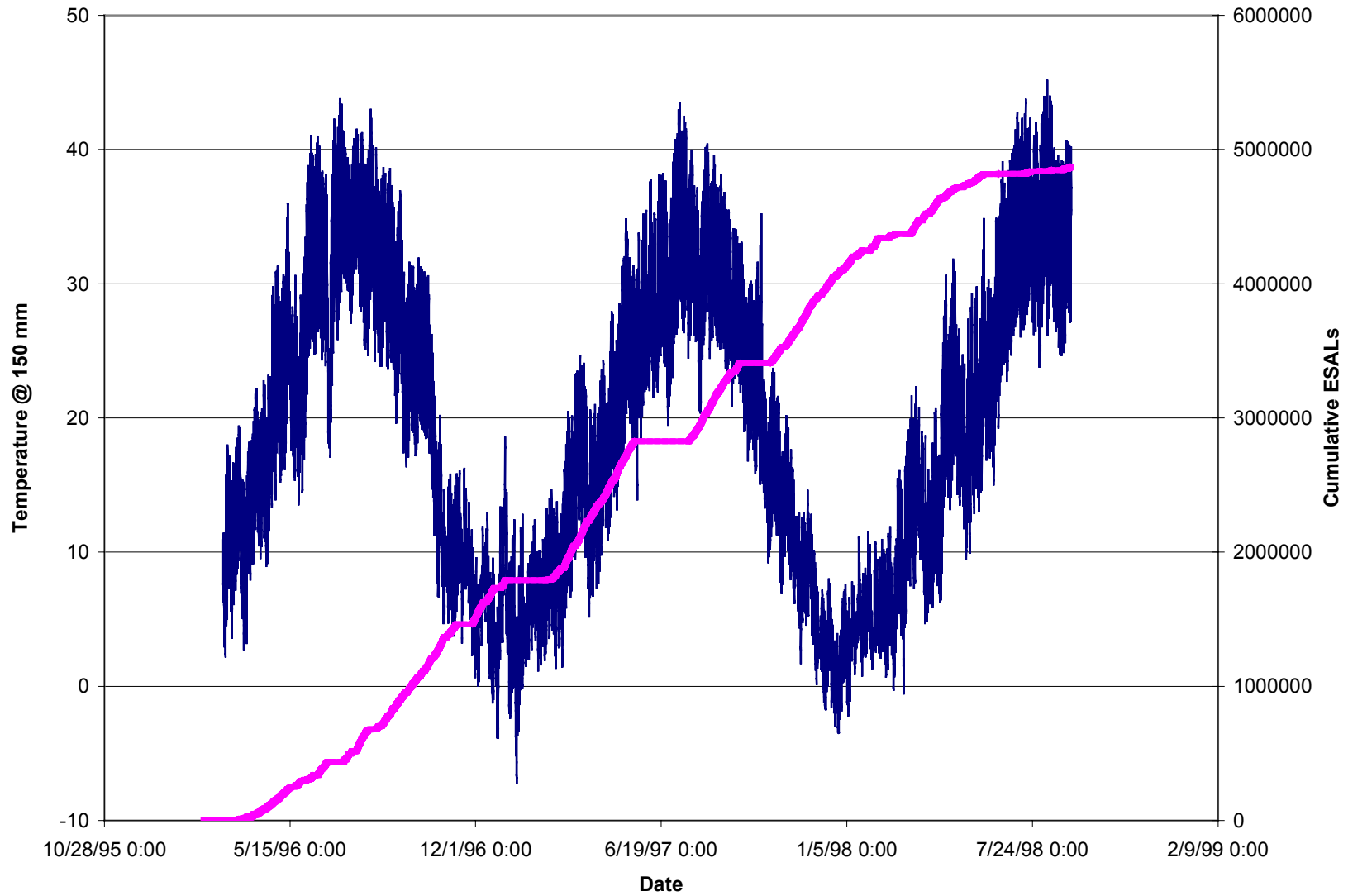

Figure 6.15. Plot of cumulative ESALs and temperature spectrum at a depth of 150 mm.

Space does not permit the presentation of the regression analyses that resulted in the following stiffness and fatigue life models. Hence, whether linear or nonlinear, all the regression analyses, including model selection, residual plots, or parameter estimations, are not illustrated here.

6.3.1 Stiffness Models

The initial stiffness of asphalt concrete is defined as the ratio of maximum stress and maximum tensile strain at the 50th repetition of the fatigue test. It was found that no significant difference in stiffness models exists between the fine and fine-plus gradations. Hence, the fine and fine-plus data were pooled together to increase the sample size to 121. The sample size for coarse gradation was 65. The regression results are listed below.

Stiffness models:

Fine and Fine-Plus

$$\ln Stif = 11.4677 - 0.0827 av - 0.2285 ac - 0.0579 temp \quad R^2 = 0.85 \quad (6.1)$$

(0.1854) (0.0051) (0.0274) (0.0028)

Coarse

$$\ln Stif = 11.4707 - 0.0576 av - 0.2142 ac - 0.0606 temp \quad R^2 = 0.79 \quad (6.2)$$

(0.5362) (0.0086) (0.0833) (0.0049)

where

- Stif* = stiffness (MPa),
- av* = percent air-void content,
- ac* = percent asphalt content,
- temp* = temperature at 150 mm (°C),
- ln = natural logarithm.

The value inside the parentheses is the standard error of the estimated coefficient. Also, notice that the signs of the regression coefficients of covariates *av*, *ac*, and *temp* are all negative. This means that increases in these covariates will decrease the magnitude of stiffness.

6.3.2 Fatigue Life Models

The fatigue life models utilized the pooled data from the WesTrack temperature sensitivity tests and WesTrack fatigue tests at 20°C. Sample size for the fine gradation was 59, fine-plus was 62, and coarse was 65. Following are the results of linear regression for each gradation.

Fatigue life models:

Fine

$$\ln Nf = -27.0265 - 0.1439 av + 0.4148 ac - 4.6894 \ln stn \quad R^2 = 0.88 \quad (6.3)$$

(1.5343) (0.0230) (0.1245) (0.1632)

Fine-plus

$$\ln Nf = -27.3409 - 0.1431 av + 0.4219 ac + 0.0127 temp - 4.6918 \ln stn \quad (6.4)$$

(1.5658) (0.0231) (0.1247) (0.0126) (0.1632)

$$R^2 = 0.88$$

Coarse

$$\ln Nf = -27.6723 - 0.0941 av + 0.6540 ac + 0.0331 temp - 4.5402 \ln stn \quad (6.5)$$

(2.3308) (0.0299) (0.2853) (0.0174) (0.1878)

$$R^2 = 0.92$$

where

- Nf = fatigue life,
- av = percent air-void content,
- ac = percent asphalt content,
- $temp$ = temperature at 150 mm (°C),
- stn = maximum tensile strain, and
- \ln = natural logarithm.

Inspecting the signs of regression coefficients of above fatigue life equations, several conclusions can be drawn as follows:

1. The $temp$ term is not included in the fatigue life equation of the fine gradation; that is, fine gradation is not temperature sensitive with respect to fatigue life.

The effects of covariates av , ac , $temp$, and stn to fatigue life are the same for all three gradations. Hence, the fatigue life will increase as ac and $temp$ increase; on the contrary, the fatigue life will decrease as av and stn increase.

The absolute magnitude of the regression coefficient for av for the coarse gradation is about 35 percent less than that for the fine and fine-plus gradation

The negative sign of the regression coefficient of strain level shows that the smaller the strain, the greater the fatigue life.

Note that the effective temperature range to which the fatigue life equations can be applied is from 5°C to 30°C. For temperatures outside of this range, extrapolation is needed.

6.4 Stratification of the WesTrack Temperature Data

As mentioned previously, the simulation period started on 3/3/96 and ended on 9/3/98. This period contains a total of 21,943 hours. The environmental and traffic variables, including T_b , g , sg , wander, and trafficking repetitions, are varied hour by hour; that is to say, the stress and strain status at the asphalt concrete layer are varied with time. It can thus be inferred that the fatigue damage is time dependent.

Generally, to assess fatigue damage, one needs to know the maximum tensile strain occurring at the bottom of asphalt concrete layer as well as the trafficking load configuration so as to calculate how much fatigue life will remain after traffic loading at a specified tensile strain level. However, to calculate the maximum tensile strain, most programs, either linear or nonlinear, require input of the layer moduli and loading configuration. The layer moduli are a function of material variables and environmental variables—temperature being the significant variable for asphalt bound layers. Since the (T_b, g, sg) embeds the inherent property of seasonal

variation, it should be regarded as an integrated unit when conducting any further analysis. Also, note that this (T_b, g, sg) group, in this case, will serve as the layer moduli variable. In sum, the objective is to stratify the observed WesTrack data into (T_b, g, sg) groups to utilize a statistical approach and reduce computational time to an acceptable level. It would be extremely burdensome to run the Circly program 21,943 times, for each simulation hour.

The idea is to subdivide T_b , g , and sg into some manageable subintervals so as to reduce the 21,943 cases. T_b ($^{\circ}\text{C}$), the temperature at the bottom of the asphalt concrete layer, will be subdivided into the following separated points, -10, 0, 10, 20, 30, 40, and 50. G ($^{\circ}\text{C}/\text{mm}$), the temperature gradient defined as $g = \frac{T_{50} - T_{150}}{100}$, starts at -0.15 and ends at 0.15 with an increase interval of 0.05, i.e., -0.15, -0.1, -0.05, 0, 0.05, 0.1, and 0.15. Sg (MPa), the subgrade modulus, based on Deacon's equation (Deacon 1998),

$$E_{sg} = \exp(9.597089 + 0.118063 \cdot \sin((day - 250.3937)/365 \cdot 2\pi)) \quad (6.6)$$

will be subdivided into subintervals starting at 90 MPa and ending at 120 MPa with an increase of 5 MPa.

It should be noted that the ranges of these three variables are defined according to the field data. Based on these subintervals of (T_b, g, sg) , a total of 216 ($6 \times 6 \times 6$) combination cases will be formed. In a sense of three-dimensional space, these subintervals will form 216 cubic cells; the 21,943 (T_b, g, sg) cases will fall into cubic cells according to their magnitudes. An S-PLUS code was written to categorize the field data into suitable cubic cells and the stratification result is listed in Appendix D. The mean values of each cell were estimated and will be utilized in the following Circly run and regression analysis. It should be noted that not every cell

contains observed field data and it turns out that only 110 (T_b, g, sg) cubic cells are found in the observed field data.

6.5 Tensile Strain Function Using Circly Program

6.5.1 WesTrack Pavement Structure and Loading Configuration

As illustrated in Figure 1.2, the pavement structure consists of a 0.15-m asphalt concrete layer, following by 0.305-m base, and the assumed infinite thickness of subgrade. The corresponding Poisson ratios are 0.35 for the asphalt concrete layer, 0.40 for the base, and 0.45 for the subgrade. The asphalt concrete layer was divided into three sublayers. The thickness of each sublayer is 0.05 m, so as to reflect the change in stiffness due to the temperature gradient. In this simulation, the moduli of the asphalt concrete and the subgrade are varied with the daily and seasonal temperature variation respectively, but the modulus of base remains the same with a value of 172.4 MPa. The moduli of asphalt concrete are based on equations 6.1 and 6.2; the moduli of the subgrade follow Equation 6.6.

6.5.2 Circly Program with 110×3×3 Cases

The possible combination cases of (T_b, g, sg) that were occupied by observed WesTrack data are 110. The values of the air-void content were decided by choosing the low, mean, and high values from the result of a UCB air-void method (Del Valle 1985) applied to the WesTrack field sample. Thus, the three air-void contents chosen for this simulation were two extremes 1.9 percent and 13.7 percent, and the mean value of 8.0 percent. Three asphalt contents that are identified in Hand's dissertation (Hand 1998) were selected—the two extremes 4.3 percent and

6.2 percent and the mean of 5.5 percent. Hence a total of 110×3×3 cases were conducted using Circly program. For each single case, the principal tensile strains at 51 locations at the bottom of asphalt concrete layer were calculated. It should be noted that there are 990 cases for the coarse mix and another 990 cases for the fine and fine-plus mixes. As compared with the 21,943 Circly runs, the 990 runs is a substantial reduction in the computation effort, not to mention the extra input and output time required while running the Circly program.

6.5.3 Bi-Normal Density Function

After inspecting the results of Circly output, it appears reasonable to represent the tensile strain profile as two overlapping normal density functions. This is hereafter referred as the bi-normal density function and has the following form:

$$\varepsilon(m_1, m_2, \sigma, A, x) = \frac{A}{\sigma\sqrt{2\pi}} \left[\exp\left(-\frac{(x - m_1)^2}{2\sigma^2}\right) + \exp\left(-\frac{(x - m_2)^2}{2\sigma^2}\right) \right] \quad (6.7)$$

where

ε is the desired tensile strain,

x is the offset,

m_1 is the mean position of the left-handed normal density function,

m_2 is the mean position of the right-handed normal density function,

σ is the standard deviation for both normal density functions, and

A is the multiplication factor.

The four parameters in the equation above are to be determined by nonlinear regression fit and will be represented as a function of (T_b, g, sg) , av , and ac .

Figure 6.16 plots the nonlinear regression fit and the Circly output results in hot weather conditions. The fitted regression curve is superposed by two normal density functions—one with mean position $m_1 = 0.0010$, the other with mean position $m_2 = 0.3551$, and the common $\sigma = 0.1361$ —with a multiplication factor $A = 0.0001435$. The corresponding simulation case is

subjected to $T_b = 41.10^\circ\text{C}$, $g = 0.1091^\circ\text{C}/\text{mm}$, $sg = 95.79\text{ MPa}$, $AV = 14.7\%$, and $AC = 6.2\%$ (coarse gradation).

Figure 6.17 is a typical output of tensile strain in cold weather. The fitted nonlinear regression curve is made by two normal density functions—one with mean position $m_1 = -0.0188$, the other with mean position $m_2 = 0.3751$, and the common $\sigma = 0.1806$ —with a multiplication factor $A = 0.0000286$. The corresponding simulation case is subjected to $T_b = -2.24^\circ\text{C}$, $g = -0.0518^\circ\text{C}/\text{mm}$, $sg = 113.30\text{ MPa}$, $AV = 14.7\%$, and $AC = 6.2\%$ (coarse gradation).

From Figures 6.16 and 6.17, several findings can be summarized:

1. The nonlinear regression fit utilizing bi-normal density functions appears to be satisfactory. Although the tail of the bi-normal density function is deviated from the calculated result, it does not affect the wander application, since fitting to the peaks is more important.

It is adequate to represent the tensile strain profile obtained by the Circly program with m_1 , m_2 , σ , and A four parameters.

The tensile strain profile is symmetrical to the position of $(m_1 + m_2)/2$.

Weather conditions cause the difference in pavement performance. In hot weather the tensile profile exhibits two peaks, in cold weather one. The magnitude of tensile strain is small in cold weather as compared to that in hot weather. In other words, fatigue damage will accumulate less in cold weather.

With the recognition that a tensile strain profile can be represented with these four parameters, the next step is to run the nonlinear regression fits based on bi-normal density functions for each single case.

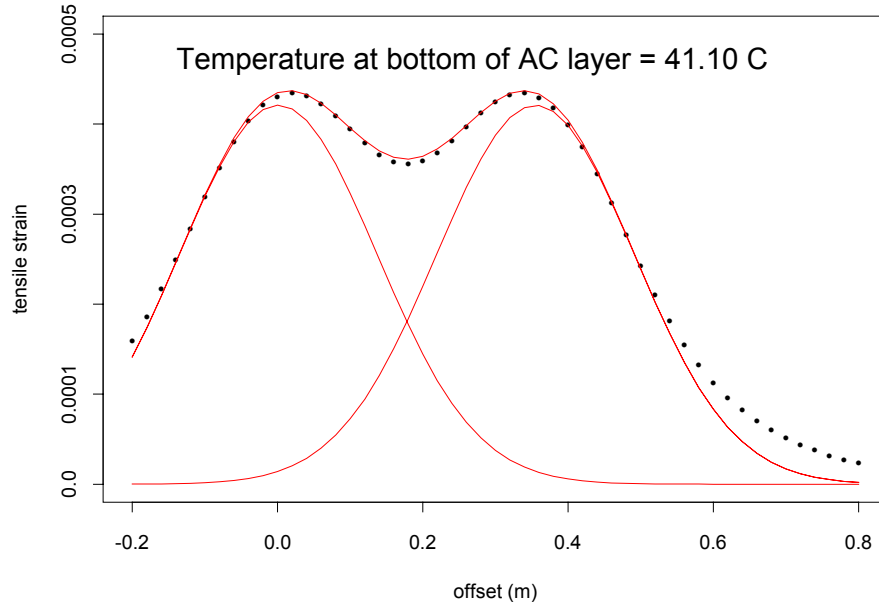

Figure 6.16. Maximum tensile strains fitted with a bi-normal distribution functions, $N(0.0010, 0.1361)$ and $N(0.3551, 0.1361)$, with a multiplication factor of $A = 0.0001435$, subjected to the following simulation case: $T_b = 41.10^\circ\text{C}$, $g = 0.1091$, $sg = 95.79\text{ MPa}$, $av = 13.7\%$, and $ac = 6.22\%$. (Note: the dots represent the tensile strains obtained from the Circly program).

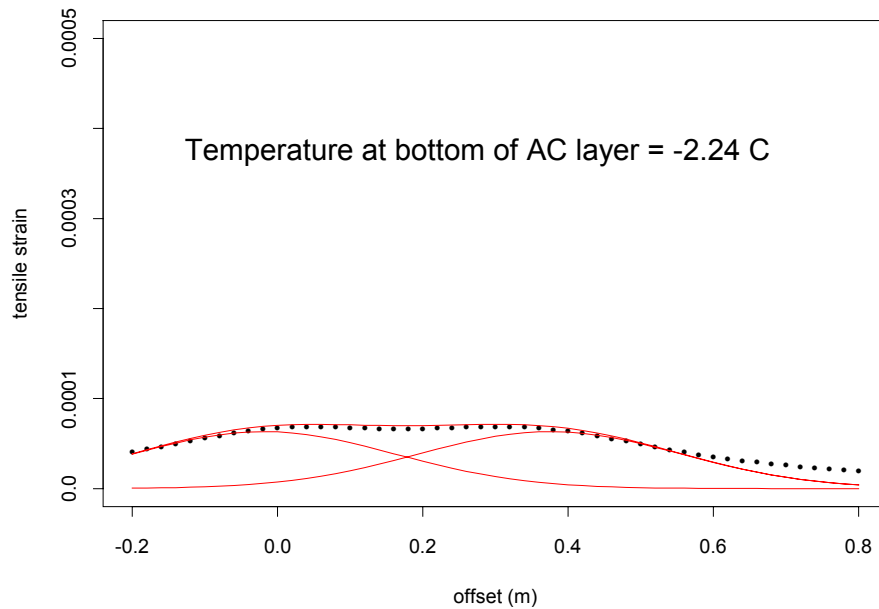

Figure 6.17. Maximum Tensile strains fitted with a bi-normal distribution functions, $N(-0.0188, 0.1806)$ and $N(0.3751, 0.1806)$, with a multiplication factor of $A = 0.0001435$, subjected to the following simulation case: $T_b = -2.24^\circ\text{C}$, $g = -0.0518$, $sg = 113.30\text{ MPa}$, $av = 13.7\%$, and $ac = 6.22\%$. (Note: the dots represent the tensile strains obtained from the Circly program).

6.5.4 Regression Analysis for Strain Function

Recall that the tensile strain profile can be represented by four parameters m_1 , m_2 , σ , and A (refer to Equation 6.7). After running the Circly program for 990×2 cases (including coarse, and fine and fine-plus gradations), the maximum principal tensile strains were extracted from the output and were piped in as the input of the nonlinear linear regression. An S-PLUS command `nls()`, which is a command that conducts the nonlinear regression fit, was utilized to determine the four parameters $\{m_1, m_2, \sigma, A\}$.

It is necessary to provide the layer moduli while running the Circly program to obtain the tensile strain profile at the bottom of the asphalt concrete layer. To calculate the layer moduli of the asphalt concrete layer, Equations 6.1 and 6.2 were utilized. Notice that these two equations contain the covariates of air-void content, asphalt content, and temperature. With 110 (T_b, g, sg) cases, three air-void levels, and three asphalt contents, each combination provides a set of $\{m_1, m_2, \sigma, A\}$ to represent the tensile strain profile at that specified $\{(T_b, g, sg), av, ac\}$ combination. Therefore, for a specific gradation type, a total of 990 sets of $\{m_1, m_2, \sigma, A\}$ were assessed through nonlinear regression analysis. However, these four parameters function as intermediate parameters because they are not of as much interest for interpreting the results as are $\{(T_b, g, sg), av, ac\}$, the five material and environment covariates. Hence, a further regression analysis was conducted to substitute $\{m_1, m_2, \sigma, A\}$ with $\{(T_b, g, sg), av, ac\}$. In other words, the strain function can be transformed into the following equation:

$$\varepsilon(\underline{X}, x) = \frac{A(\underline{X})}{\sigma(\underline{X})\sqrt{2\pi}} \left[\exp\left(-\frac{(x - m_1(\underline{X}))^2}{2\sigma(\underline{X})^2}\right) + \exp\left(-\frac{(x - m_2(\underline{X}))^2}{2\sigma(\underline{X})^2}\right) \right]$$

where the \underline{X} vector stands for the $\{(T_b, g, sg), av, ac\}$ vector.

It was found that the results of regression analyses are improved if the temperature gradients are treated separately in subintervals. That is, in each temperature gradient subinterval, the $\{m_1, m_2, \sigma, A\}$ parameters have their own regression equations.

The general specifications of regression equations for the four parameters $\{m_1, m_2, \sigma, A\}$ are listed below:

$$m_1 = C_0 + C_1 T_b g + C_2 T_b sg + C_3 T_b g^2 + C_4 T_b sg^2 + C_5 G + C_6 Sg + C_7 av + C_8 ac + C_9 T_b g \cdot av + C_{10} T_b sg \cdot av + C_{11} T_b g \cdot ac + C_{12} T_b sg \cdot ac + C_{13} av \cdot ac + \varepsilon$$

$$m_2 = C_0 + C_1 m_1 + \varepsilon$$

$$\sigma = C_0 + C_1 m_1 + C_2 m_1^2 + C_3 m_1^3 + C_4 m_1^4 + C_5 m_1^5 + \varepsilon$$

and

$$A = C_0 + C_1 T_b g + C_2 T_b sg + C_3 T_b g^2 + C_4 T_b sg^2 + C_5 G + C_6 Sg + C_7 av + C_8 ac + C_9 T_b g \cdot av + C_{10} T_b sg \cdot av + C_{11} T_b g \cdot ac + C_{12} T_b sg \cdot ac + C_{13} av \cdot ac + \varepsilon$$

where

C_i is the regression coefficients,

$T_b g$ is a term generated by multiplying T_b and g ,

$T_b sg$ is a term generated by multiplying T_b and sg ,

$T_b g^2$ is the square of $T_b g$,

$T_b sg^2$ is the square of $T_b sg$,

$T_b g \cdot av$ is the interaction term of $T_b g$ and av ,

$T_b g \cdot ac$ is the interaction term of $T_b g$ and ac ,

$T_b sg \cdot av$ is the interaction term of $T_b sg$ and av ,

$T_b sg \cdot ac$ is the interaction term of $T_b sg$ and ac , and

ε is the error term.

The sample size of each temperature gradient subinterval is listed in the following: 36 for $[-0.15, -0.10]$, 189 for $[-0.10, -0.05]$, 207 for $[-0.05, 0.0]$, 207 for $[0.0, 0.05]$, 207 for $[0.05, 0.10]$, and 144 for $[0.10, 0.15]$.

The details of the regression analysis are not presented here. Tables 6.3a through 6.3d and 6.4a through 6.4d tabulate the regression results for both coarse mix and fine and fine-plus mixes respectively.

6.6 Fatigue Performance Prediction Simulation (Crack Initiation)

6.6.1 Simulation Procedures

For simplicity, Section 8 at WesTrack will serve as a demonstration to explain how the fatigue performance prediction simulation is completed and evaluated. The simulation procedure is manipulated using the S-PLUS software. The simulation tasks included the following:

- Construct input matrix and find four parameters of strain function,
- Compute the tensile strains with offsets,
- Determine the fatigue life with offsets,
- Construct the repetition matrix, and
- Evaluate the fatigue damage matrix and apply Miner's Law.

6.6.1.1 Input Matrix and Four Parameters Strain Function

A basic input matrix, named $tbgs_g$ (the subscript 8 representing test section 8), including five columns for T_b , g , sg , av , and ac was constructed on an hourly basis. That is,

$$tbgs_g = \begin{bmatrix} T_b & g & sg & av & ac \\ \vdots & \vdots & \vdots & \vdots & \vdots \\ \vdots & \vdots & \vdots & \vdots & \vdots \end{bmatrix}_{21943 \times 5}$$

As stated earlier, 21,943 is the total number of recorded hours of WesTrack from 3/3/96 to 9/3/98. Next, according to the regression coefficients of Tables 6.3a to 6.3d for coarse mix

Table 6.3a Results of Regression Coefficients m_1 of Coarse Mixes at Different Temperature Gradient Intervals

gradient	[-0.15,-0.10]	[-0.10,-0.05]	[-0.05,0.0]	[0.0,0.05]	[0.05,0.10]	[0.10,0.15]
Intercept	-0.08175863	-0.03479309	-0.03411011	-0.0431191	-0.03614109	-0.03233883
Tbg	0.01950062			0.03462285		
Tbsg		6.717861e-6	6.793519e-6		6.942432e-6	7.675834e-6
Tbg^2	0.002959697			-0.009660887		
Tbsg^2		-3.21376e-11	-1.247114e-10		-2.164686e-10	-3.704025e-10
G		0.0845437	0.03453812		0.05250905	0.04367304
Sg	0.0009615674		-0.00002152473	0.00002656082		-0.00003846102
Av	0.001093299	0.0006746544	0.0006666258	0.0006601759	0.0006720647	0.0006863074
Ac	0.003705114	0.00226696	0.002230678	0.002233238	0.002180534	0.002211977
Tbg*av	0.0001268999			-0.0002971607		
Tbsg*av		-5.584353e-8	-6.137919e-8		-7.738638e-8	-8.894092e-8
Tbg*ac	0.0004663344			-0.001021566		
Tbsg*ac		-2.0672e-7	-2.257651e-7		-2.846534e-7	-3.27908e-7
Av*ac	-0.00002792679	-0.00001991557	-0.00002062941	-0.00001568069	-0.00002628364	-0.00002838366
R^2	0.9959	0.9972	0.9971	0.9875	0.9965	0.999

Table 6.3b Results of Regression Coefficients m_2 of Coarse Mixes at Different Temperature Gradient Intervals

gradient	[-0.15,-0.10]	[-0.10,-0.05]	[-0.05,0.0]	[0.0,0.05]	[0.05,0.10]	[0.10,0.15]
Intercept	0.3562	0.3562	0.3562	0.3561	0.3562	0.3562
M1	-1.0066	-1.0053	-1.0062	-1.0071	-1.0085	-1.0095
R^2	0.9999	1.0000	1.0000	1.0000	1.0000	1.0000

Table 6.3c Results of Regression Coefficients σ of Coarse Mixes at Different Temperature Gradient Intervals

gradient	[-0.15,-0.10]	[-0.10,-0.05]	[-0.05,0.0]	[0.0,0.15]	[0.15,0.10]	[0.10,0.15]
Intercept	0.1431	0.1423	0.1426	0.1445	0.1412	0.1409
M1	-5.5021	-3.5916	-4.9619	-8.6655	-4.0365	-21.2729
M1^2	-125.6612	-182.4311	-126.0442	-224.8148	-308.7180	-283.9384
M1^3		-8698.2050	-668.5057		-22427.9359	15039.9723
M1^4		-226481.9409			-873964.3969	
M1^5		-2393516.9861			-13472803.3775	
Sin(m1/0.01)	0.0216		0.0166	0.0453		0.172
R^2	0.9999	0.9998	0.9999	0.9958	0.9999	0.9998

Table 6.3d Results of Regression Coefficients A of Coarse Mixes at Different Temperature Gradient Intervals

gradient	[-0.15,-0.10]	[-0.10,-0.05]	[-0.05,0.0]	[0.0,0.05]	[0.05,0.10]	[0.10,0.15]
Intercept	-13.39914	-11.58667	-11.12271	-11.49544	-12.01581	-11.10854
Tbg	1.53532			2.294153		
Tbsg		0.0005025015	0.0004804504		0.0004590989	0.0005093146
Tbg^2	0.2220458			-0.5428994		
Tbsg^2		-1.161947e-9	-5.566515e-9		-1.683449e-9	-1.405131e-8
G		6.384203	0.6557571		5.63907	2.487178
Sg	0.05892822		-0.006828288	-0.002321114		-0.007310587
v	0.06316996	0.04783163	0.04758049	0.04731206	0.04742552	0.04794235
Ac	0.2173902	0.1641741	0.163119	0.1601871	0.1608133	0.1615919
Tbg*av	0.005865289			-0.01427007		
Tbsg*av		-3.361553e-6	-3.468244e-6		-3.921476e-6	-4.321448e-6
Tbg*ac	0.02175577			-0.0527957		
Tbsg*ac		-0.0000124667	-0.00001285962		-0.00001453973	-0.00001601667
Av*ac	-0.00146397	-0.001153217	-0.001164524	-0.001324928	-0.001308766	-0.001402494
R^2	0.9987	0.9923	0.9985	0.9962	0.9917	0.9974

Table 6.4a Results of Regression Coefficients m_1 of Fine and Fine-plus Mixes at Different Temperature Gradient Intervals

Gradient	[-0.15,-0.10]	[-0.10,-0.05]	[-0.05,0.0]	[0.0,0.05]	[0.05,0.10]	[0.10,0.15]
Intercept	-0.07988474	-0.03634856	-0.03691352	-0.04270346	-0.03327317	-0.03607125
Tbg	0.0159674			0.03393941		0.006677723
Tbsg		7.199499e-6	6.842651e-6		7.529676e-6	
Tbg^2	0.002579341			-8.99276e-3		-0.0003165719
Tbsg^2		-1.351548e-10	-1.361373e-10		-3.466108e-10	
G		0.07178455	0.02041707			
Sg	0.0008506537			2.267549e-5		0.00004793386
Av	0.001564374	0.00100384	0.0009612834	0.001012483	0.0009535552	0.0009445551
Ac	0.003935108	0.002520002	0.002413306	0.002475931	0.002344938	0.002294424
Tbg*av	0.0001833901			-0.0004657914		-0.000101136
Tbsg*av		-9.289788e-8	-9.387046e-8		-1.124367e-7	
Tbg*ac	0.0004900334			-0.001215362		-0.0002752519
Tbsg*ac		-2.543658e-7	-2.57598e-7		-3.074625e-7	
Av*ac	-0.000046345	-0.0000360965	-3.451985e-5	-0.0000428518	-0.0000418012	-0.00004531004
R^2	0.9929	0.9971	0.9967	0.9898	0.9943	0.9976

Table 6.4b Results of Regression Coefficients m_2 of Fine and Fine-plus Mixes at Different Temperature Gradient Intervals

gradient	[-0.15,-0.10]	[-0.10,-0.05]	[-0.05,0.0]	[0.0,0.05]	[0.05,0.10]	[0.10,0.15]
Intercept	0.3562	0.3562	0.3562	0.3560	0.3562	0.3561
M1	-1.0073	-1.0062	-1.0069	-1.0086	-1.0096	-1.0103
R^2	0.9999	1.0000	1.0000	1.0000	1.0000	0.9999

Table 6.4c Results of Regression Coefficients σ of Fine and Fine-plus Mixes at Different Temperature Gradient Intervals

gradient	[-0.15,-0.10]	[-0.10,-0.05]	[-0.05,0.0]	[0.0,0.15]	[0.15,0.10]	[0.10,0.15]
Intercept	0.1425	0.1423	0.1422	0.1485	0.1411	0.1409
M1	-6.7044	-6.4943	-6.5630	-3.3726	-4.2418	-4.4155
M1 ²	-162.0980	-157.8808	-160.1644	-57.7235	-379.9716	-503.7375
M1 ³					-31839.2312	-58146.4542
M1 ⁴					-1396525.8838	-3559716.1828
M1 ⁵					-23722319.7929	-84038344.7616
Sin(m1/0.01)	0.0310	0.0294	0.0304	0.0073		
R ²	0.9999	0.9998	0.9998	0.9968	0.9998	0.9998

Table 6.4d Results of Regression Coefficients A of Fine and Fine-plus Mixes at Different Temperature Gradient Intervals

gradient	[-0.15,-0.10]	[-0.10,-0.05]	[-0.05,0.0]	[0.0,0.05]	[0.05,0.10]	[0.10,0.15]
Intercept	-13.41943	-11.60635	-11.93162	-11.52406	-11.99708	-11.81081
Tbg	1.319236			2.235742		0.4622427
Tbgs		0.0004821816	0.0004740113		0.0004566367	
Tbg ²	0.1982441			-0.5164648		-0.01628367
Tbgs ²		1.14947e-9	-2.061125e-9		-3.015393e-9	
G		5.958508	-2.517388		5.119211	
Sg	0.05352491			-0.002119558		0.002269168
Av	0.09092601	0.06912625	0.06805976	0.06760431	0.06782119	0.06745517
Ac	0.2349178	0.1777141	0.1748931	0.1720754	0.1727083	0.1707851
Tbg*av	0.008588157			-0.02108253		-0.005128277
Tbgs*av		-5.169588e-6	-5.12326e-6		-5.737562e-6	
Tbg*ac	0.02376517			-0.05790203		-0.01413554
Tbgs*ac		-0.00001428444	-0.00001414514		-0.00001582453	
Av*ac	-0.002397742	-0.001936588	-0.001916482	-0.002129637	-0.002135857	-0.002265763
R ²	0.9975	0.9919	0.9933	0.9967	0.9926	0.9975

and Tables 6.4a to 6.4d for fine and fine-plus mixes, a matrix, named $tbgs\text{g.coef}_8$, with four parameters m_1 , m_2 , σ , and A , of the strain function can thus be calculated

$$tbgs\text{g.coef}_8 = \begin{bmatrix} m_1 & m_2 & \sigma & A \\ \vdots & \vdots & \vdots & \vdots \\ \vdots & \vdots & \vdots & \vdots \end{bmatrix}_{21943 \times 4}$$

In sum, for each hour, there exists a unique set of $\{m_1, m_2, \sigma, A\}$ that forms a specific strain function for that specified set of T_b , g , sg , av , and ac .

6.6.1.2 Tensile Strains with Offsets

Because the four parameters m_1 , m_2 , σ , and A can define a continuous function of maximum tensile strain, it is possible to identify the magnitude of tensile strain caused by wander. While the applied traffic loading is in a no-wander position, the location that incurs most fatigue damage is set at the point of maximum tensile strain. The Newton-Raphson algorithm was utilized to resolve the position of maximum tensile strain. An S-PLUS program called `findsolnr()` (Appendix D) was utilized for this step. Figure 6.18 illustrates the method used to estimate the strain with wander. As can be seen, the maximum tensile strain occurs at position x_m for the no-wander condition. If there is wander loading at a distance L on the right side of the no-wander position, then the tensile strain occurring at x_m is going to be $\epsilon(x_m - L)$. Conversely, if the wander loading is at a distance L on the left side, then the tensile strain occurring at x_m is going to be $\epsilon(x_m + L)$. Therefore, for each hour, the tensile strains at different wander locations can thus be calculated and represented in matrix form as follows:

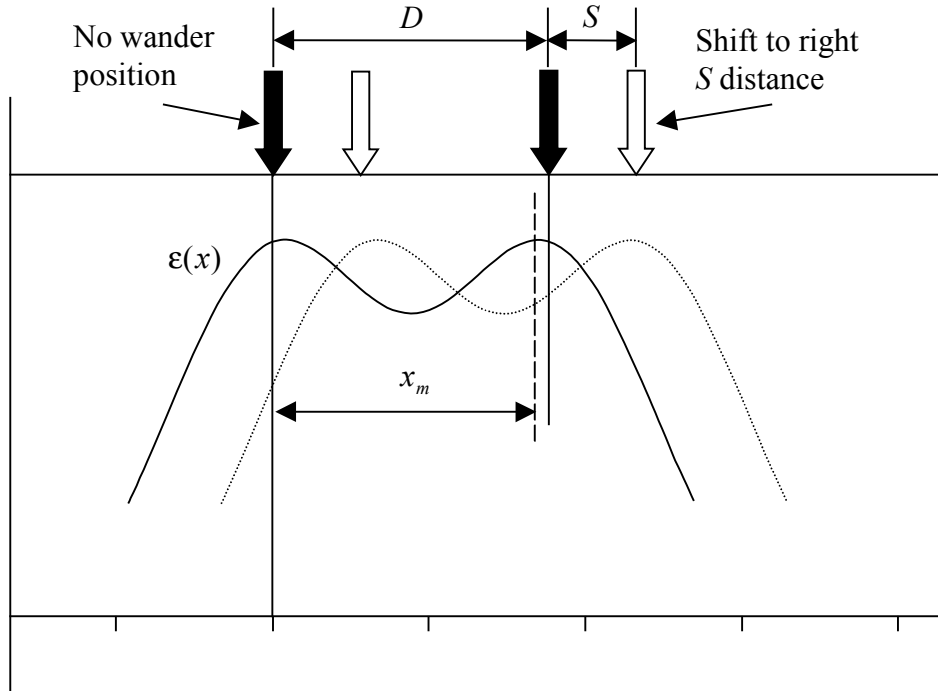

Note: $\epsilon(x_m) = \epsilon(x_m - S)$, if shift to right S distance.
 $\epsilon(x_m) = \epsilon(x_m + S)$, if shift to left S distance.

Figure 6.18. Illustration of tensile strain calculation with wander.

$$stn_8 = \begin{bmatrix} 5L & 4L & 3L & 2L & 1L & Center & 1R & 2R & 3R & 4R & 5R \\ \vdots & \vdots & \vdots & \vdots & \vdots & \vdots & \vdots & \vdots & \vdots & \vdots & \vdots \\ \vdots & \vdots & \vdots & \vdots & \vdots & \vdots & \vdots & \vdots & \vdots & \vdots & \vdots \end{bmatrix}_{21943 \times 11}$$

The calculations of tensile strains at various wander locations are based on the location of the maximum tensile strain, x_m , obtained from the no-wander situation. It should be noted that the location of maximum tensile strain varies with temperature and therefore changes each hour.

6.6.1.3 Fatigue Life with Offsets

Once the strains have been calculated for each wander position and each hour, the fatigue-resistant capacity at each entry of matrix stn_g can be computed based on the laboratory-obtained fatigue life equations. For instance, the fatigue life matrix of the coarse mix has the following form:

$$Nf_g = \exp \left(-27.6723 - 0.0941 \cdot \begin{bmatrix} av \\ \vdots \\ \vdots \end{bmatrix} + 0.654 \cdot \begin{bmatrix} ac \\ \vdots \\ \vdots \end{bmatrix} + 0.0331 \cdot \begin{bmatrix} T_b \\ \vdots \\ \vdots \end{bmatrix} - 4.5402 \cdot \log[stn_g] \right)$$

The dimensions of matrices $[av]$, $[ac]$, $[T_b]$, stn_g , and Nf_g are all 21943×11 . Note that $[av]$ and $[ac]$ are constant matrices because av and ac were maintained the same during this simulation. The $[T_b]$ matrix is a temperature matrix, which is prepared by a column vector of 21,943 temperatures and then duplicated 11 times. The fatigue life equations utilized in this simulation are varied by gradation types: Equation 6.3 for fine gradation, Equation 6.4 for fine-plus gradation, and Equation 6.5 for coarse gradation.

6.6.1.4 Repetition Matrix

In the Circlay layered-elastic theory simulations the actual loads and their repetitions were used rather than the 40-kN (9,000-lb.) wheel load associated with the ESALs. Also, as mentioned in Chapter 2, a multiplication factor of 0.7633 needs to be applied to convert the ESALs (original traffic data format) into repetitions for the specific loading configuration of WesTrack. For the traffic and wander data, a matrix named $REPS_g$, with the same dimension as the stn_g matrix, can be constructed as follows:

$$REPS_8 = \begin{bmatrix} R_{5L} & R_{4L} & R_{3L} & R_{2L} & R_{1L} & R_{Center} & R_{1R} & R_{2R} & R_{3R} & R_{4R} & R_{5R} \\ \vdots & \vdots & \vdots & \vdots & \vdots & \vdots & \vdots & \vdots & \vdots & \vdots & \vdots \\ \vdots & \vdots & \vdots & \vdots & \vdots & \vdots & \vdots & \vdots & \vdots & \vdots & \vdots \end{bmatrix}_{21943 \times 11}$$

It should be noted that the repetitions applied to the “OFF” position in the original data set, meaning that the truck was maneuvered by a driver, were evenly distributed to the other 11 positions.

6.6.1.5 Fatigue Damage Matrix and Miner’s Law

Accordingly, the failure criterion is set as $\sum \frac{n_i}{N_i} = 1$, where n_i represents the applied repetitions at entries of the matrix $REPS_8$. N_i is the fatigue-resistant capacity as expressed in the entries of matrix Nf_8 . If the cumulative ratio reaches one, then it is said that the crack initiation is triggered at the bottom of the asphalt concrete layer. The fatigue damage matrix is thus defined as

$$\frac{REPS_8}{Nf_8} = \begin{bmatrix} \frac{R_{5L}}{Nf_{5L}} & \frac{R_{4L}}{Nf_{4L}} & \frac{R_{3L}}{Nf_{3L}} & \frac{R_{2L}}{Nf_{2L}} & \frac{R_{1L}}{Nf_{1L}} & \frac{R_{Center}}{Nf_{Center}} & \frac{R_{1R}}{Nf_{1R}} & \frac{R_{2R}}{Nf_{2R}} & \frac{R_{3R}}{Nf_{3R}} & \frac{R_{4R}}{Nf_{4R}} & \frac{R_{5R}}{Nf_{5R}} \\ \vdots & \vdots & \vdots & \vdots & \vdots & \vdots & \vdots & \vdots & \vdots & \vdots & \vdots \\ \vdots & \vdots & \vdots & \vdots & \vdots & \vdots & \vdots & \vdots & \vdots & \vdots & \vdots \end{bmatrix}_{21943 \times 11}$$

The summation of ratios in each row in the above matrix indicates the cumulative fatigue damage caused by the trafficking load at that hour. Accordingly, a plot of hourly cumulative fatigue damage versus hourly cumulative repetitions can be drawn, as shown in Figure 6.19. The plot represents the “with wander” cumulative fatigue damage curve. To construct the “without wander” damage curve, it is assumed that the total hourly repetitions are applied only at the central position (the black arrow position in Figure 6.18). In the laboratory, the controlled-strain flexural fatigue tests are conducted with a constant strain level. Since, it is recognized that

Section 8:coarse,AV=8.5,AC=5.47.(3/3/96~9/3/98)

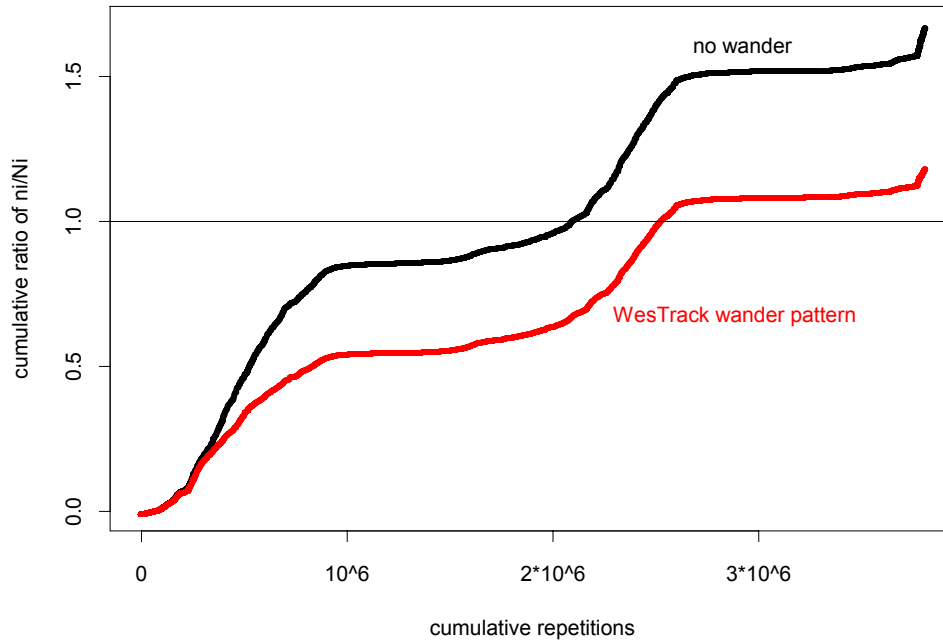

Figure 6.19. Fatigue performance prediction of crack initiation with and without wander for Section 8.

compounding strain history is found in a specific location in the asphalt concrete layer, it is necessary to further evaluate the wander effect if the laboratory fatigue tests are to be applied in the field.

The following is a sample S-PLUS log to exemplify the methodology used to predict crack initiation.

```
> # section 8:coarse,AV=8.5,AC=5.47
> tbgsg.coef<-stnregfunc(tbgsg[,1],tbgsg[,2],tbgsg[,3],8.5,5.47)
> range(tbgsg.coef[,3])
[1] 0.1356376 0.1938631
> tbgsg.coef8<-tbgsg.coef
> rm(tbgsg.coef)
> dim(tbgsg.coef8)
[1] 22627 4
> stn8<-findmatstns(tbgsg.coef8)
> dim(stn8)
[1] 22627 11
> nf8<-exp(-27.6723-0.0941*8.5+0.654*5.47+0.0331*tbgsg[1:21943,1]-4.5402*log(stn8[1:21943,]))
> dim(nf8)
[1] 21943 11
> ratio8center<-esalcenter/nf8[,6]
> ratio8<-ratiomat(nf8,esal)
```

```

> plot(cumsum(esalcenter),cumsum(ratio8center),xlab="cumulative ESALs",ylab="cumulative ratio of
ni/Ni",main="Section 8:coarse,AV=8.5,AC=5.47. 3/3/96~9/3/98")
> points(cumsum(esalcenter),ratio8,col=2)
> abline(h=1)
> text(locator(1),"with no wander")
> text(locator(1),"with WesTrack Wander Pattern",col=2)
> dev.copy(win.printer,file="clipboard",format="metafile")
> dev.off()
>

```

Figure 6.19 shows the output of this methodology. It should be kept in mind that the crack initiation is defined as when the summation of ratios, $\sum \frac{n_i}{N_i}$, reaches one.

6.6.2 Simulation Results

Following the procedure discussed above, the crack initiation time and its corresponding cumulative repetitions for both wander and no-wander cases, can be evaluated in an efficient way. Figures B.6.1 to B.6.8 present the simulation results for coarse gradation, Figures B.6.9 to B.6.17 for fine gradation, and Figures B.6.18 to B.6.26 for fine-plus gradation. Table 6.5 summarizes the simulation results and the condition surveys for fatigue performance of the 26 original test sections of WesTrack project. Figure 6.20 illustrates the contents of Table 6.5. The results categorized by gradation type are shown in Figures 6.21 through 6.23. Note that in Figures 6.20 to 6.23 the first diamond (◆) in the time axis represents the crack initiation time without wander and the second diamond the crack initiation time with wander. For the condition survey results, the first cross (×) stands for the 10 percent surface fatigue cracking and the second cross the 50 percent surface fatigue cracking.

As a general observation, in spite of the difference in percent air-void content, percent asphalt content, and gradation, the 26 original test sections display the same type of fatigue damage curves not only in the “with wander” case but also in the “without wander” case. It can be conjectured that this is because all 26 sections were subjected to the same simulation

Table 6.5 Summary Table of Fatigue Performance Prediction and Condition Survey Data of WesTrack

Section No.	Mix Type	AV (%)	AC (%)	Reps @Center		Reps @Wander		10% fatigue cracking		50% fatigue cracking	
				Reps	Date	Reps	Date	ESAL	Date	ESAL	Date
5	Coarse (Non-Critical)	8.1	5.63	2,255,114	10/24/96	3,698,621	08/11/97	1,757,238	12/30/96	2,311,472	04/08/97
6		10.8	5.71	606,774	08/03/96	1,888,032	09/22/96	1,668,205	12/16/96	1,794,207	02/19/97
7		6.9	6.49	3,786,621	08/11/97	DNO	09/03/98	DNO	09/03/98	DNO	09/03/98
8		8.5	5.47	2,076,977	09/26/96	2,507,188	07/31/97	1,515,380	12/01/96	1,789,150	01/01/97
23		4.9	5.79	DNO	03/09/98	DNO	09/03/98	DNO	09/03/98	DNO	09/03/98
24		7.2	5.94	2,525,817	07/26/97	DNO	04/06/98	DNO	09/03/98	DNO	09/03/98
25		3.7	6.55	DNO	09/03/98	DNO	09/03/98	DNO	09/03/98	DNO	09/03/98
26		11	5.31	550,317	07/30/96	1,358,144	09/02/96	1,487,207	11/29/96	1,626,490	12/10/96
1	Fine (Critical)	8.8	5.55	341,549	06/17/96	387,558	06/21/96	DNO	09/03/98	DNO	09/03/98
2		10.4	4.92	266,730	06/08/96	277,101	06/14/96	2,899,176	07/26/97	DNO	09/03/98
3		12.4	4.97	219,394	05/12/96	231,000	05/14/96	3,585,531	11/05/97	4,340,103	02/18/98
4		6.6	5.12	513,676	07/28/96	833,323	08/23/96	DNO	09/03/98	DNO	09/03/98
14		9	6.05	318,975	06/16/96	354,101	06/18/96	DNO	09/03/98	DNO	09/03/98
15		8.7	5.42	347,832	06/20/96	395,017	06/22/96	DNO	09/03/98	DNO	09/03/98
16		12.2	4.75	229,994	05/14/96	236,768	05/21/96	3,720,800	11/17/97	DNO	09/03/98
17		11	5.74	244,454	06/06/96	259,553	06/07/96	4,227,572	01/18/98	DNO	09/03/98
18		4.3	6.04	2,091,353	09/14/96	2,489,843	08/02/97	DNO	09/03/98	DNO	09/03/98
9	Fine Plus (Super-Critical)	7.2	5.89	473,673	07/26/96	719,415	08/07/96	DNO	09/03/98	DNO	09/03/98
10		10.9	5.88	255,845	06/06/96	267,610	06/08/96	DNO	09/03/98	DNO	09/03/98
11		4.2	6.75	2,195,380	10/07/96	3,432,750	08/10/97	DNO	09/03/98	DNO	09/03/98
12		8.1	5.23	406,488	07/16/96	521,132	07/28/96	DNO	09/03/98	DNO	09/03/98
13		3.9	6.56	2,322,881	04/23/97	DNO	08/21/97	DNO	09/03/98	DNO	09/03/98
19		11.8	5.28	238,956	05/25/96	247,211	06/03/96	1,750,322	12/29/96	4,215,885	01/17/98
20		7.9	5.99	405,359	07/16/96	528,188	07/28/96	DNO	09/03/98	DNO	09/03/98
21		4.6	5.84	2,205,678	10/07/96	2,662,463	08/08/97	DNO	09/03/98	DNO	09/03/98
22		5.9	6.51	628,477	08/04/96	2,108,536	10/03/96	DNO	09/03/98	DNO	09/03/98

Note: DNO stands for "did not occur."

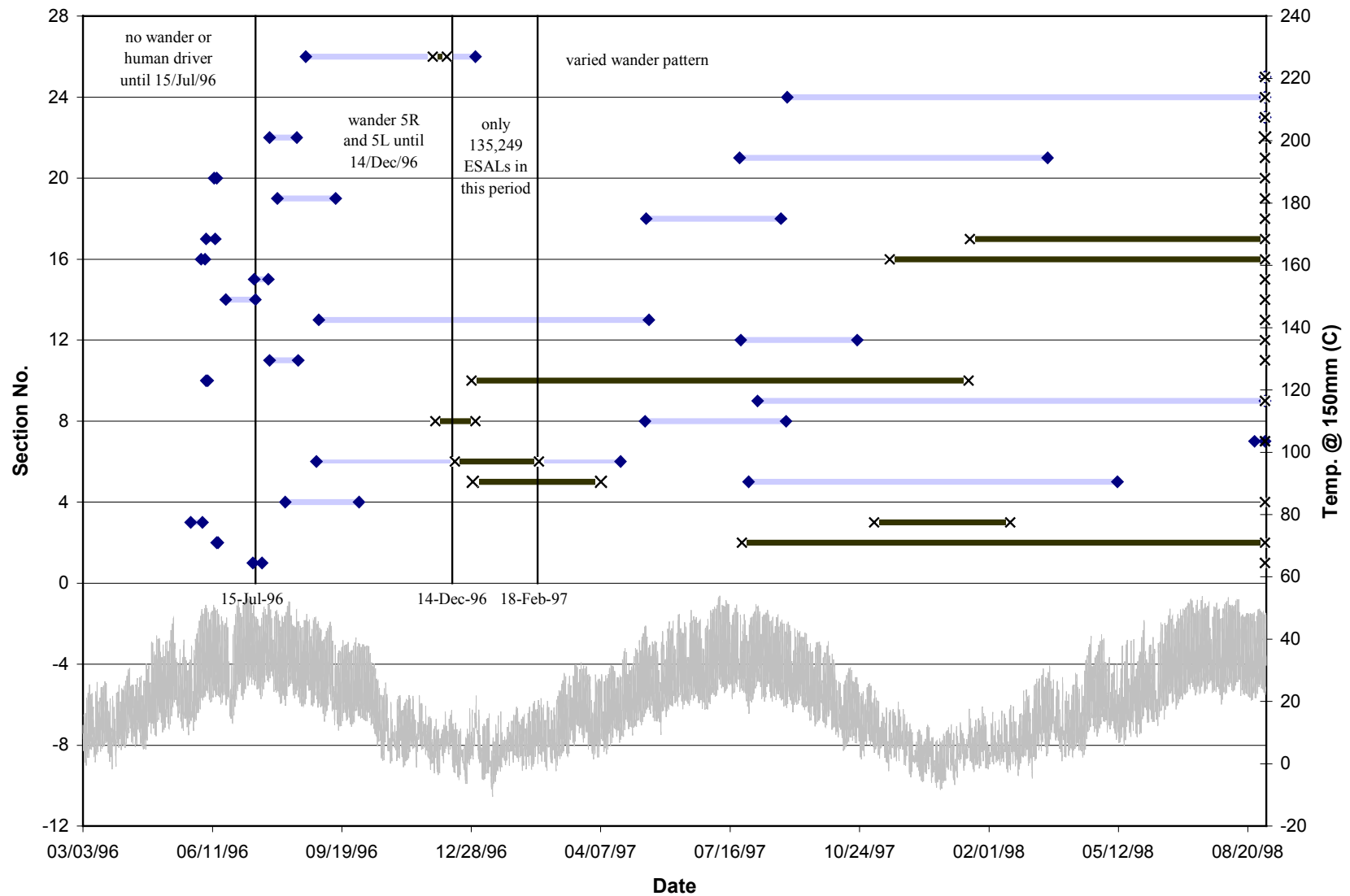

Figure 6.20. Simulation results of fatigue performance prediction and condition survey of 26 original test sections of the WesTrack project. (Note: the left \blacklozenge means the result of no wander; the right \blacklozenge is the result of no wander; the left \times means the result of 10 % fatigue cracking and the right \times is the 50 % fatigue cracking.)

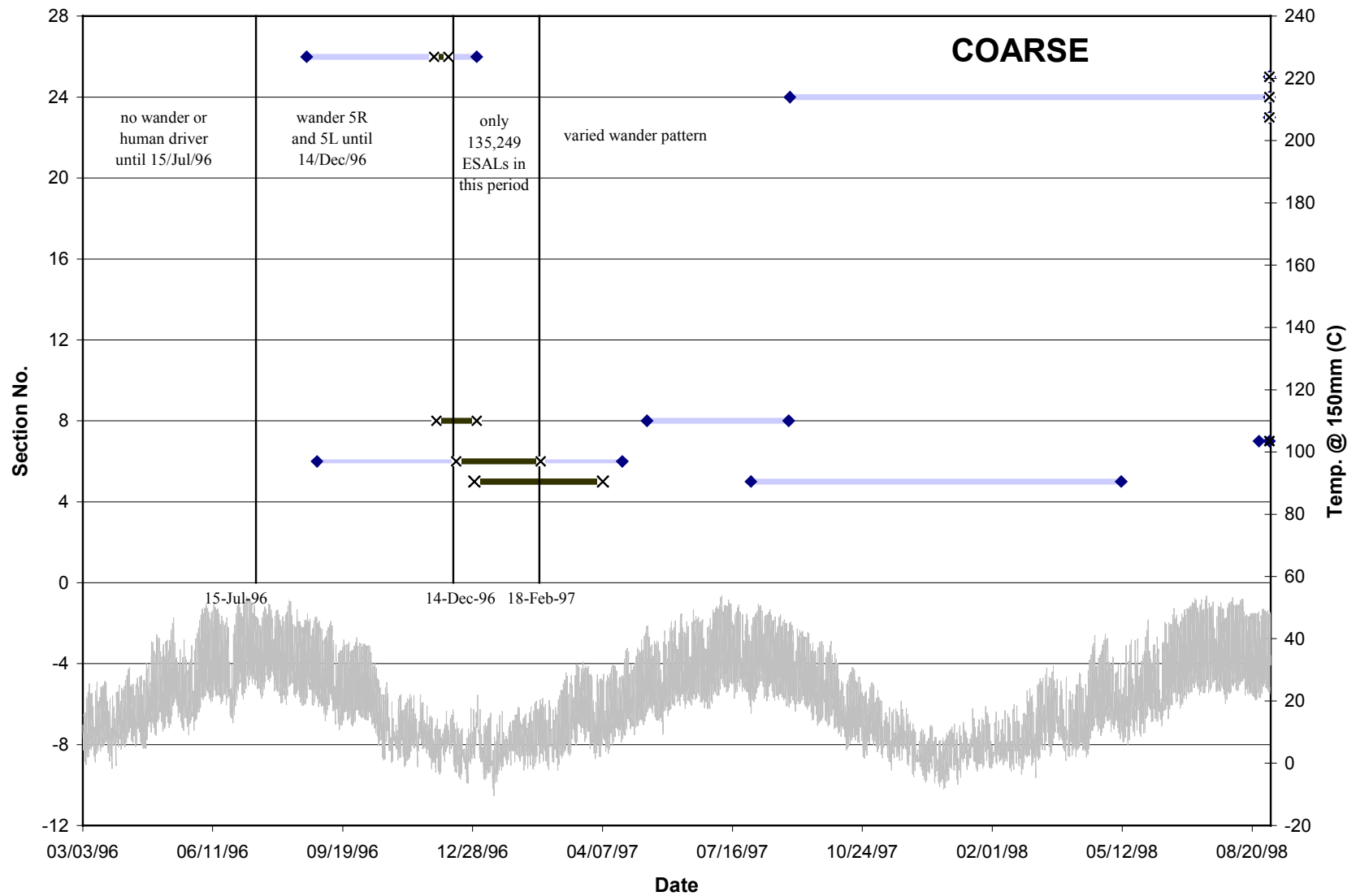

Figure 6.21. Simulation results of fatigue performance prediction and condition survey of coarse mixes of the WesTrack project. (Note: the left ♦ means the result of no wander; the right ♦ is the result of no wander; the left x means the result of 10 % fatigue cracking and the right x is the 50 % fatigue cracking.)

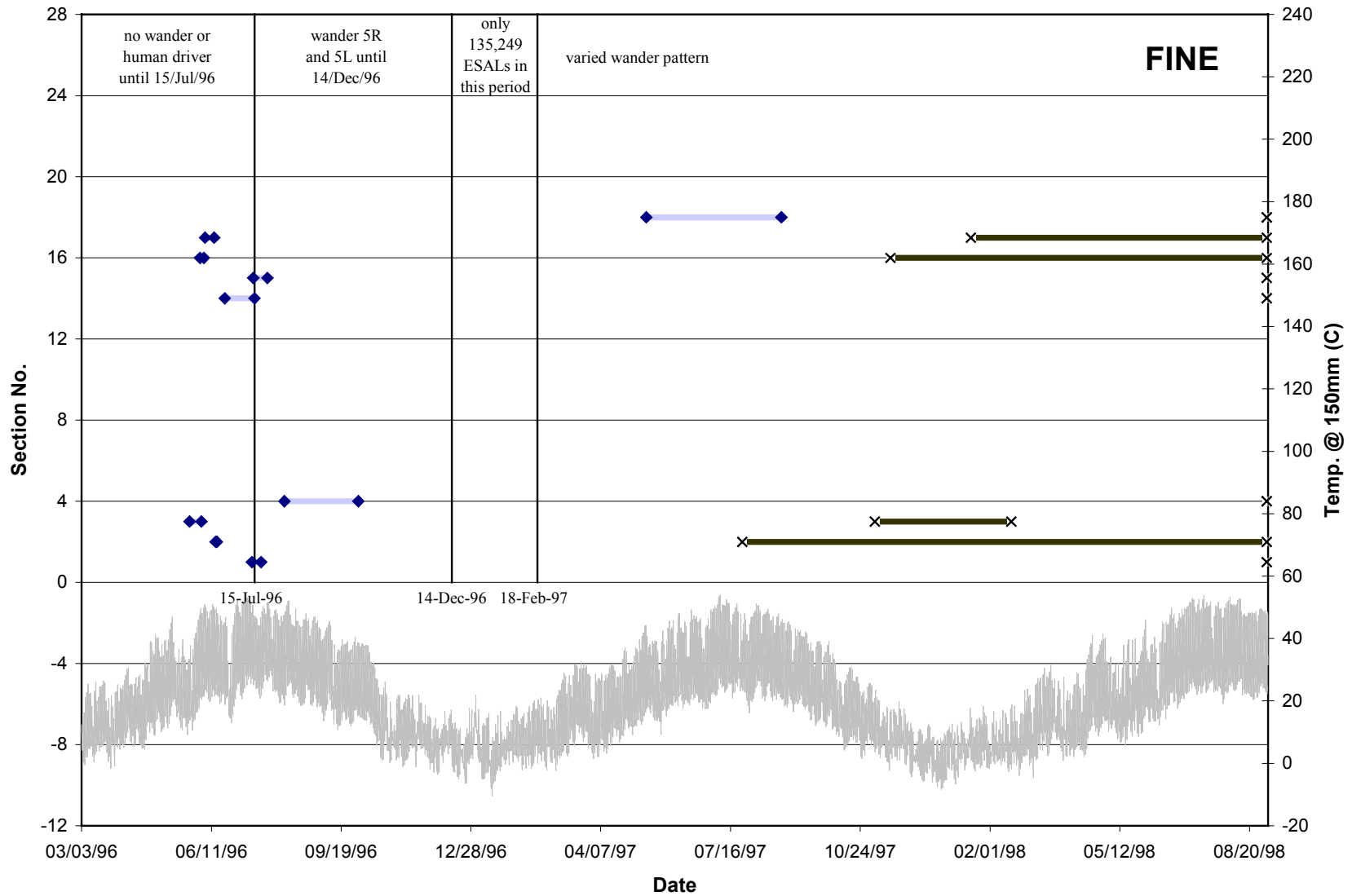

Figure 6.22. Simulation results of fatigue performance prediction and condition survey of fine mixes of the WesTrack project. (Note: the left \blacklozenge means the result of no wander; the right \blacklozenge is the result of no wander; the left \times means the result of 10 % fatigue cracking and the right \times is the 50 % fatigue cracking.)

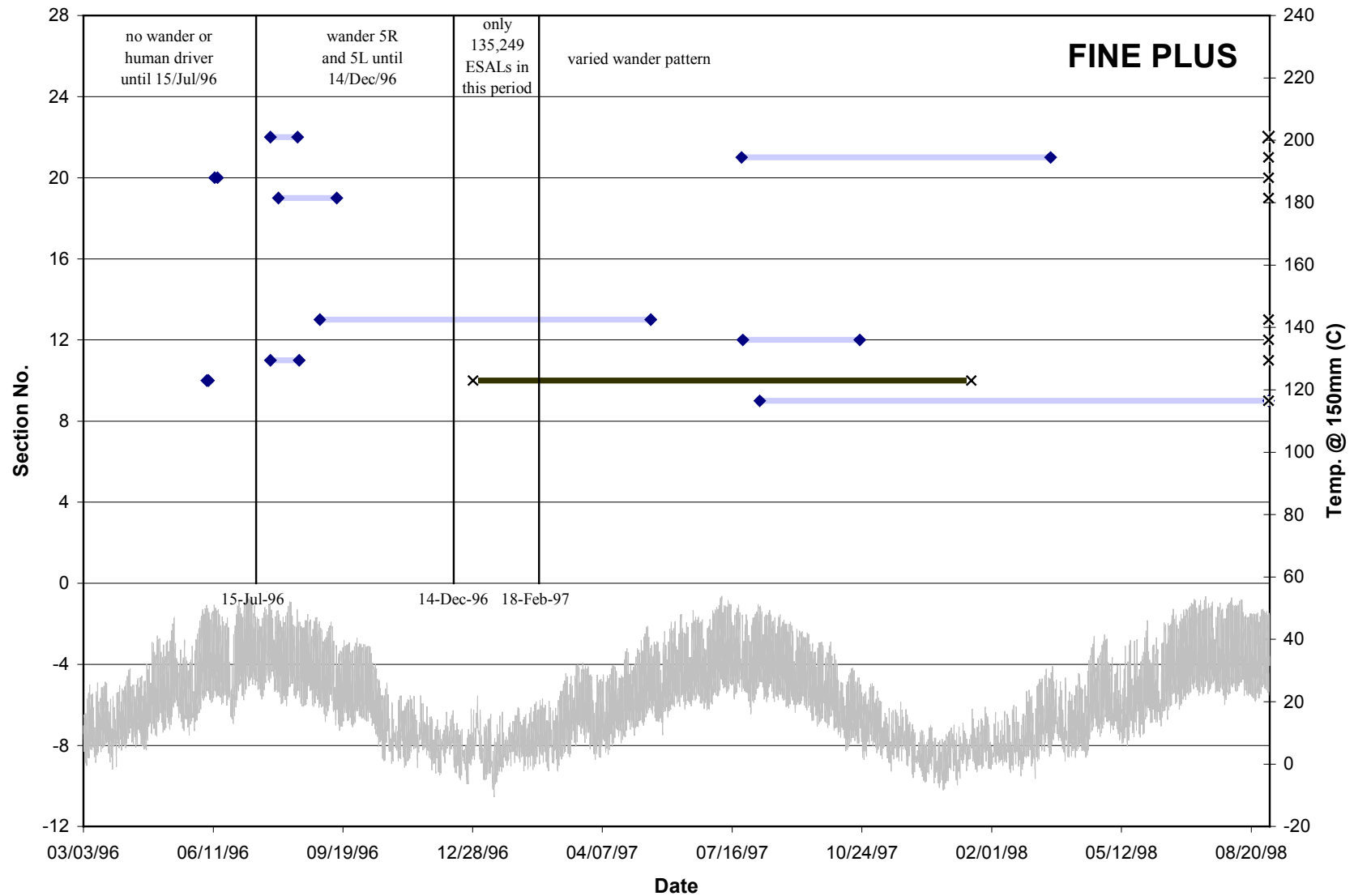

Figure 6.23. Simulation results of fatigue performance prediction and condition survey of fine-plus mixes of the WesTrack project. (Note: the left \blacklozenge means the result of no wander; the right \blacklozenge is the result of no wander; the left \times means the result of 10% fatigue cracking and the right \times is the 50% fatigue cracking.)

conditions, i.e., the same temperature spectrum, the same pavement structure, and the same traffic pattern. However, the cumulative rate of ratio n_i/N_i is different for the different mixes. Since n_i represents applied traffic and is the same for all 26 sections, the differences in the cumulative rates are due to differences in mix stiffness and fatigue response, which are expressed in the mechanistic-empirical stiffness and fatigue life equations.

In the simulation results shown in Figures B.6.1 to B.6.26, two “plateaus” (horizontal part of the fatigue damage curve representing a slow rate of damage accumulation) occur during two repetition periods, 9.2×10^5 through 2.1×10^6 repetitions and 2.7×10^6 through 3.5×10^6 repetitions. These two periods correspond to the time periods, 10/13/96 ~ 5/18/97 and 10/24/97 ~ 4/11/98, which are over the winter and spring seasons. This suggests that in cold seasons the cumulative fatigue damage rate is comparably less than that in hot seasons.

6.7 Findings and Discussions

Whether viewed by mechanistic analysis, statistical modeling, or understanding of the fatigue damage process, the simulation methodology introduced herein is not a perfect approach that can predict exact fatigue performance. Rather, it is an approach that, like a myopic eye, can identify distant objects but with a blurred image. Although the methodology is not complete at this moment, several disadvantages can be pinpointed.

1. Apparently, this simulation methodology does not take into account the fact that the stiffness of the asphalt concrete layer deteriorates as the fatigue damage gradually accumulates. However, the effect of stiffness deterioration on the fatigue performance can be assessed by using the Weibull theory to conduct a dynamic analysis, as will be seen in Chapter 7.

In this simulation methodology, the fatigue resistant capacity of field asphalt concrete pavement was directly substituted by the laboratory obtained fatigue life equations.

However, this neglects the fact that the boundary conditions of a laboratory test setup are different than those of field pavement. A correction factor (or a shift factor) should be introduced to compensate for this difference.

In the stratification process, the total number of cases was reduced from 21,943 to 110. Each cubic cell, formed by T_b , g , and sg , contains a different number of observations, and is “weighted” differently. However, in this chapter, the mean values of each cubic cell were utilized to conduct the regression analysis.

Several findings and conclusions from the simulation results of the WesTrack project are addressed below.

1. Both the simulation results and the condition survey data reinforce the important role of air-void content in fatigue performance. However, the change of air-void content due to trafficking compaction was not included in this simulation methodology; instead, the air-void content was maintained the same during the whole simulation process. It has been found in current laboratory investigations that the air-void contents of WesTrack samples decreased after trafficking and exhibited a trend similar to that of a soil consolidation curve. Thus changes in air-void contents occurring in asphalt concrete pavement cannot be neglected and must be included in the simulation methodology, once the behavior of the change of air-void content is truly understood.
2. For coarse mixes containing air-void contents greater than 10 percent, such as that used in test sections 6 and 26, the predicted crack initiation times were ahead of the

actual surface cracking that occurred in the first winter. Sections with medium to low air-void contents had predicted crack initiation times in the second winter, but surface cracks never appeared during the life of the project. It is worthwhile to pay attention to the test sections 5 and 8 where surface cracks developed in the first winter before the predicted crack initiation time. Implicitly, it might indicate that utilizing the fatigue theory alone will not truly explain the cumulative fatigue damage caused by the combined effects of cold weather and traffic load. In addition, an adequate crack propagation model applied for cold temperatures should be superimposed with the fatigue theory to obtain reasonable estimates.

3. For fine mixes, the test sections containing air-void contents greater than 10 percent had predicted crack initiation times in the very early trafficking stage. The corresponding surface cracks developed in the second winter but the 50 percent surface cracking was never observed. For the sections with low to medium air-void contents, the 10 percent surface cracks never occurred. Also, though the sections were trafficked in no-wander or human driver situations during the period 3/3/96 to 7/15/96, no obvious difference exists in the predicted crack initiation times between the “with wander” and “without wander” cases.
4. For fine-plus mixes, the sections with medium to high air-void contents presented early predicted crack initiation times of around the first summer. The predicted crack initiation times of sections with low air-void contents were during the first winter and the second summer. However, for all these sections; no actual surface cracking has been perceived. On the whole, from the simulation results and condition survey data

it seems that the fine-plus mixes have better resistance to fatigue damage than do the fine mixes when both mixes have equal air-void contents.

5. Finally, a summary of experience gained applying this simulation methodology of fatigue performance prediction of crack initiation time to pavement design as follows:

With regard to Correction Factor (CF):

- a. *Coarse mix:*

Major cracks (10–50 percent cracking) will occur at next winter after the predicted crack initiation time.

- b. *Fine mix:*

Major cracks will happen at the second winter after the predicted crack initiation time.

- c. *Fine-plus mix:*

Major cracks will develop more than two winters later unless the air-void content is greater than 10 percent. If this is the case, then subtract one winter.

7.0 WEIBULL SIMULATION

7.1 General Considerations

A *Weibull* program that is coded and entitled according to the Weibull theory, as discussed in Chapter 5, was used to conduct the Weibull simulation to predict the fatigue performance (crack initiation, at present) of an in-situ pavement. The following paragraphs give a brief introduction to the Weibull program and the related factors affecting fatigue performance that are incorporated into the program.

7.1.1 Algorithm of Weibull Program

Before describing the algorithm of the Weibull program, the assumptions postulated in Chapters 4 and 5 will be restated:

1. *For every testing situation containing many variables, there exists one and only one associated stiffness deterioration curve in the SR-N space. If the testing situation changes from one state to the other at a given instant (repetition), the stiffness deterioration rate will follow the rate of the new state, starting immediately at that specific instant (repetition).*
2. *The SR cannot be increased.*

In addition, two additional assumptions will be postulated to complete the basis for the algorithm of the *Weibull* program:

3. *If there is no traffic, even though daily or seasonal temperature variations exist, the SR remains unchanged (i.e., aging and thermal effects have no effect on fatigue performance).*

4. *During each hour (WesTrack specific), the fatigue damage caused by traffic application at random wander positions is equivalent to the fatigue damage accumulated by applying traffic in a sequential and sorted order of wander positions.*

It has already been stated in Chapter 5 how to construct the compound stiffness deterioration curve in terms of a stiffness ratio and changes in material or environment variables using assumptions 1 and 2 above. Assumptions 3 and 4 will now be incorporated to complete the Weibull dynamic algorithm to include traffic wander and environment factors in compliance with specific WesTrack data. This algorithm can be termed “hour-by-hour” or “node-by-node.”

Each node in Figure 7.1 represents a wander position that has been subjected to traffic loading. Each hour consists of several or no nodes. For the specific wander pattern at WesTrack, each hour will consist of at most 11 nodes (each node representing a specific wander location of WesTrack). Each hour will be characterized by a set of environmental variables. The execution flow is wander-oriented, i.e., in a sequential and sorted order as shown by the direction of the arrow in Figure 7.1, i.e., “node-by-node” and “hour-by-hour” complying with assumptions 3 and 4. Notice that the stiffness will be changed node by node due to the stiffness deterioration calculated from the Weibull regression equation (assumptions 1 and 2). The ELSYM5 layered-elastic theory program will be called up to analyze strain at each node. The environmental situation is assumed to remain the same during each hour.

7.1.2 Program Elements and Flow Charts

The central parts of the *Weibull* program are the “ELSYM5 strain engine” and the Weibull algorithm that has been discussed in previous sections. The strain engine is a modification of the original ELSYM5 program (Ahlborn 1972) to create an independent subroutine that can be called by the *Weibull* program to return the values of tensile strain

Wander Pattern

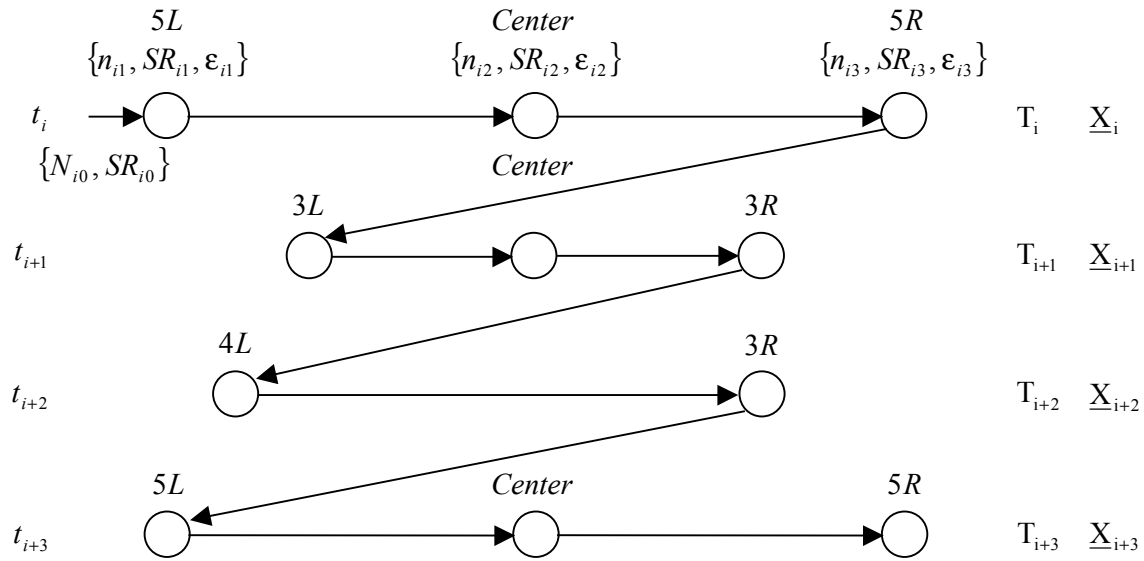

Where,

- t_i = ith time period,
- n_{ij} = trafficking ESALs at time period i and loading location j,
- N_{i0} = cumulative ESALs at time period i and loading location 0,
- SR_{ij} = stiffness ratio at time period i and loading location j,
- ϵ_{ij} = maximum tensile strain at time period i and loading location j,
- T_i = bottom temperature of AC layer at time period i,
- \underline{X}_i = a vector of material variables at time period i,
- NR = the wander (loading center) is N inch to the right of Center,
- NL = the wander is N inch to the left of Center, and
- Center = no wander occurred.

Figure 7.1. “Node-by-node” and “hour-by-hour” algorithm of *Weibull* program.

whenever the layer stiffness is varied due to a change of the pavement temperature and stiffness deterioration. The *Weibull* program was written in FORTRAN 90 and compiled by the Microsoft FORTRAN Power Station 4.0. The following briefly describes the modules and their corresponding major subroutines. Figure 7.2 illustrates the relationship between the modules and subroutines.

7.1.2.1 Module *Strain_Engine*

Module *Strain_Engine*

```

use ELSYM5_Program
use Link_List

subroutine strain_calculation(infile_unit, infile, center, wander, nnz, &
                             stn, avgstn)
subroutine make_image(center, old_x, old_stn, new_x, new_stn, d)
subroutine mirror_array(center, n, old_array, new_array)
function interpolation(point1, point2, xpos)
subroutine reduce_matrix(nnz, nnxy, pe_array, new_array)
subroutine find_array_strain(n, list, x, stn)
subroutine find_array_maxpos(n, list, maxpos)
subroutine find_array_avgstn(nz, nxy, list, avgstn)

```

This module calls up the other two modules, namely *ELSYM5_Program* and *Link_List*.

This module provides a main subroutine, *strain_calculation()*, to calculate the intended maximum principal tensile strains.

7.1.2.2 Module *ELSYM5_Program*

Module *ELSYM5_Program*

```

subroutine tensile_strain(infile_unit, infile, nnz, nnxy, pe_array)

```

The main subroutine of this module is *tensile_strain()*. This subroutine is obtained by modifying the original *ELSYM5* program to take the same *ELSYM5* input file and return an array consisting of the principal tensile strains (including ϵ_1 , ϵ_2 , and ϵ_3) at the locations specified in the input file.

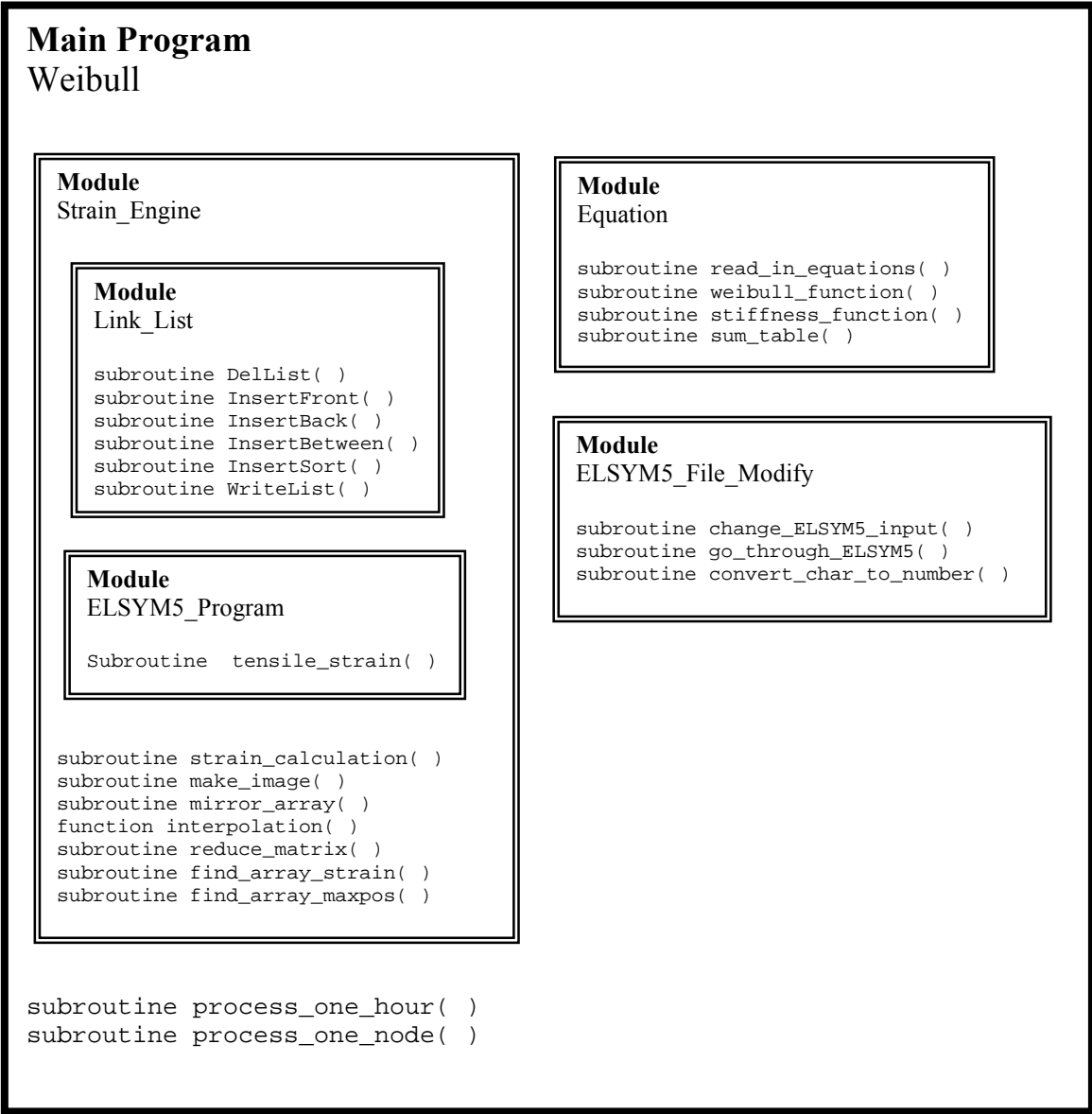

Figure 7.2. Module relationship of *Weibull* program.

7.1.2.3 Module Link_List

Module Link_List

```
subroutine DelList(list)
subroutine InsertFront(head,a,b)
subroutine InsertBack(head,a,b)
subroutine InsertBetween(head,PredPtr,CurrPtr,temp)
subroutine InsertSort(head,a,b)
subroutine WriteList(head)
```

This is the utility module that consists of several useful subroutines to manipulate the linked list. The six subroutines `DelList()`, `InsertFront()`, `InsertBack()`, `InsertBetween()`, `InsertSort()`, and `WriteList()` make up this module.

7.1.2.4 Module Equations

Module equations

```
subroutine read_in_equations(infile_unit,infile,wbl,stif)
subroutine weibull_function(coef_wbl,n0,av,ac,vma,temp,rs4s50,m200,stn,delta_n,phi,dsr)
subroutine sum_table(coef_wbl,n,av,ac,vma,temp,rs4s50,m200,stn,sum,gamma)
subroutine stiffness_function(coef_stif,av,ac,vma,temp,stif)
```

The main purpose of this module is to read in and perform the calculation of the Weibull and stiffness regression equations. The disadvantage of this module resides in its inflexible arrangement of variables within regression equations. For the Weibull regression equation, only the constant term `CONST` and the covariates (or independent variables) `AV`, `AC`, `VMA`, `TEMP`, `RS4S50`, `M200`, `LN(STN)`, `LN(N)`, and `LN(LN(N))` can be included. As with the stiffness regression equation, the covariates included are `AV`, `AC`, `VMA`, and `TEMP`. The sequence of these covariates is very important because the input file of the regression equations is coded according to this order. And, the input format will be presented as a symmetrical matrix to incorporate the interaction terms.

7.1.2.5 Module ELSYM5_File_Modify

Module ELSYM5_File_Modify

```
subroutine change_ELSYM5_input(infile_unit,infile,outfile_unit,outfile,stif)
```

```

subroutine go_through_ELSYM5(infile_unit,infile,center,nxy,nz,zout)
subroutine convert_char_to_number(string,number)

```

This module serves the purpose of changing the layer stiffness in the ELSYM5 input file whenever factors that affect stiffness exist, such as changes in temperature or traffic application.

7.1.2.6 Main Program Weibull_Simulation

Program Weibull_Simulation

```

Use equations
Use Strain_Engine
Use ELSYM5_File_Modify

subroutine process_one_hour(infile_unit,infile,center,nz,nout,&
                           tb,g,sg,base,av,ac,vma,rs4s50,m200,&
                           coef_wbl,coef_stif,n0,traffic,&
                           cum_reps,phi,sr_old,sr_new,&
                           sr_old_nowander,sr_new_nowander,&
                           sr_old_avg,sr_new_avg,&
                           sr_old_nw_avg,sr_new_nw_avg)

subroutine process_one_node(infile_unit,infile,center,wander,&
                           sg,base,av,ac,vma,temp,rs4s50,m200,s0,&
                           nxy,nz,n0,dn,coef_wbl,cum_reps,phi,&
                           sr_old,sr_new,sr_old_avg,sr_new_avg,&
                           sr_old_nowander,sr_new_nowander,&
                           sr_old_nw_avg,sr_new_nw_avg)

```

The main program `Weibull_Simulation` utilizes three modules: `Equations`, `Strain_Engine`, and `ELSYM5_File_Modify`. It also contains two subroutines called `process_one_hour()` and `process_one_node()`.

7.1.2.7 Flowchart

The flowchart of the main program is briefly illustrated in Figure 7.3. As can be seen from this flowchart, the essential part is the subroutine `process_one_hour()`, which conducts all the calculations of stiffness ratio. The detailed flowchart of `process_one_hour()` is listed in Figure 7.4. From Figure 7.4, it is easy to see why these two main subroutines `process_one_hour()` and `process_one_node()` are named in such a way, for the algorithm is executed “hour-by-hour” and “node-by-node”.

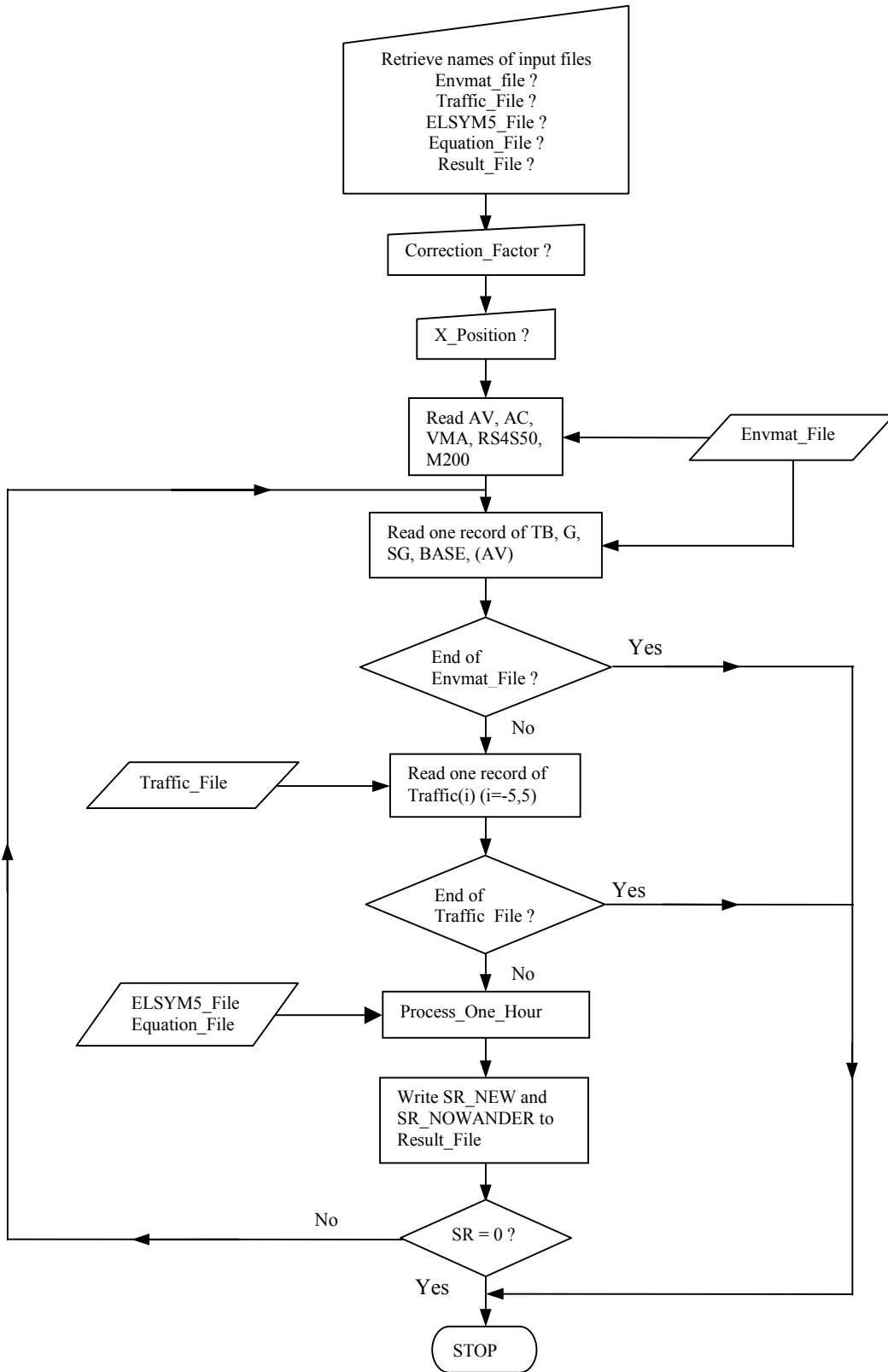

Figure 7.3. Flow chart of *Weibull* main program.

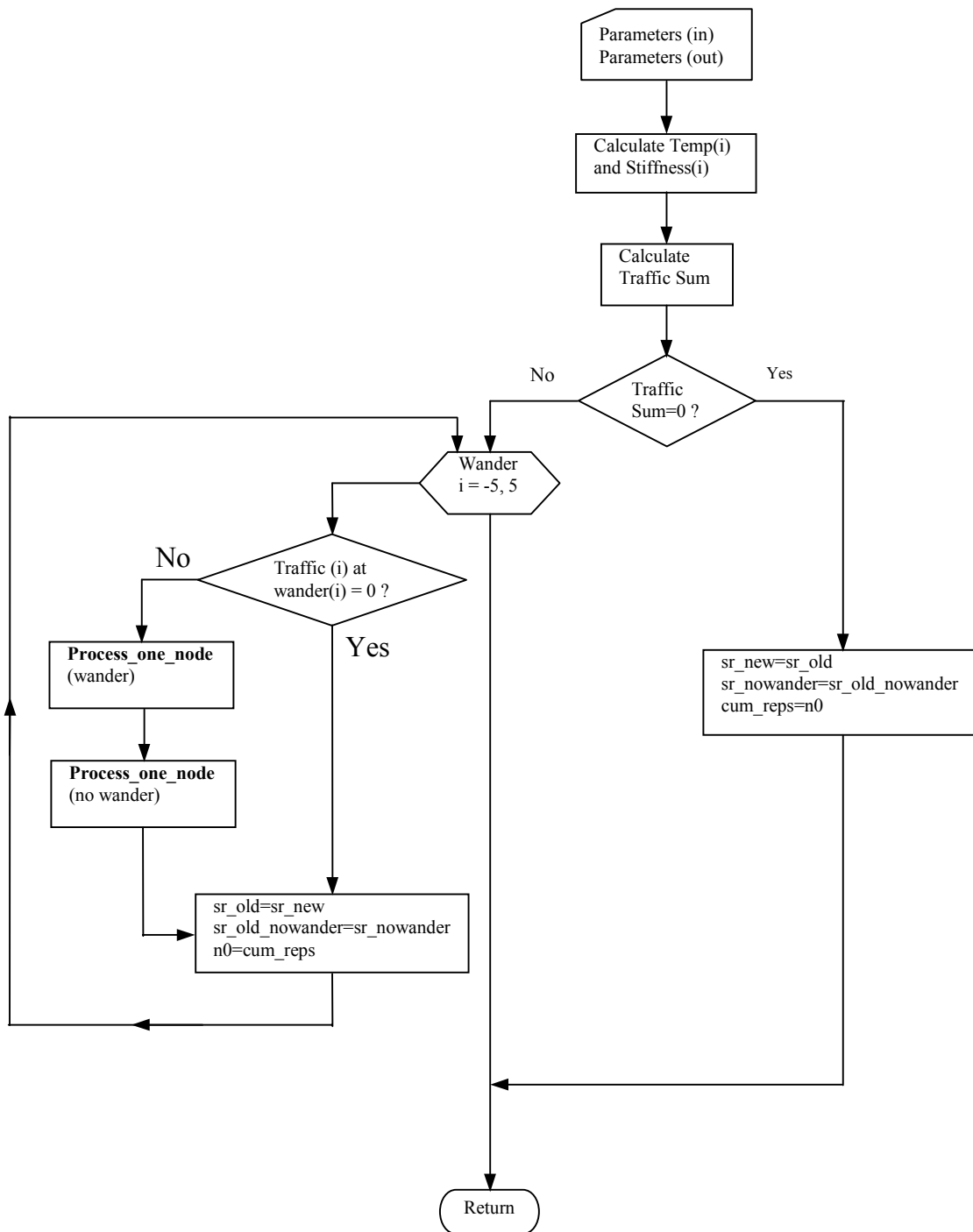

Figure 7.4. Flow chart of the `process_one_hour()` subroutine.

7.1.3 Scope of Simulation

7.1.3.1 Pavement structure and range of simulation

Figure 7.5 represents the corresponding pavement structure, the loading configuration of a dual-tire, coordinate setup, and the intended strain-calculation points. Notice that the origin of this coordinate system is under the center of left tire. The depths used to calculate the strain are 1, 3, 5, and 5.99 inches below the surface (English units are used here because of limitations of the ELSYM5 code). The horizontal points are located at 8, 9, 10, 11, 12, 13, 14, 15, 17, and 19 inches off the origin. In this chapter, the fatigue damage results for the asphalt layer will be presented in terms of a two-dimensional image-and-contour plot based on a total of 40 points, containing four depths multiplied by ten horizontal points.

7.1.3.2 Simulation cases

The simulation cases cover only the 26 originally constructed test sections of the WesTrack project—the overlap and replacement sections are not included here. In addition, several simulation cases were run to verify the effect of traffic pattern, weather pattern, construction variability, and the correction factor. Construction variations include the effects of compaction, thickness, and asphalt content.

7.1.3.3 Initial stiffness equations

The regression equation for initial stiffness used for the coarse gradation is

$$E(\ln stif) = 10.6586 - 0.2211 ac - 0.00607 av - 0.0633 temp + 0.0703 vma$$

(0.7081) (0.0927) (0.0095) (0.0029) (0.0306)

$$R^2 = 0.88$$

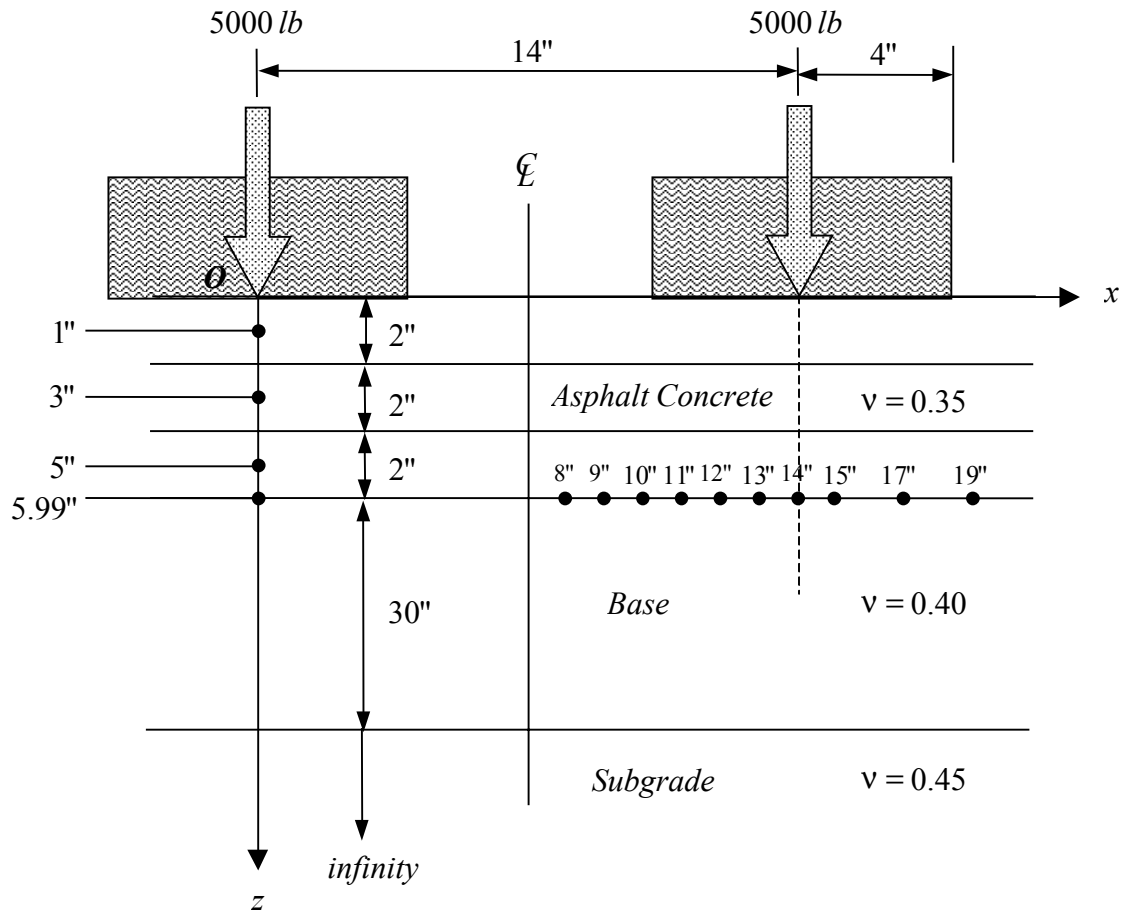

Note: Not to scale.

Figure 7.5. Loading configuration, pavement structure, and ELSYM5 input of WesTrack for Weibull simulation.

The regression equation for initial stiffness utilized for the fine and fine-plus gradations is as follows:

$$E(\ln stif) = 11.3220_{(0.1941)} - 0.2133_{(0.0304)} ac - 0.0808_{(0.0055)} av - 0.0548_{(0.0021)} temp$$

$$R^2 = 0.87$$

7.1.3.4 Weibull equations

Two Weibull regression equations will be applied in the simulation, one for coarse gradation, the other for fine and fine-plus gradations.

For the coarse gradation:

$$E(\ln(-\ln(SR))) = 105.8248_{(8.6671)} - 1.8679_{(0.0793)} av + 17.4844_{(0.8926)} \ln stn + 1.1902_{(0.1702)} temp - 10.3682_{(1.2809)} rs4s50$$

$$- 8.8144_{(0.6664)} m200 + 4.8639_{(0.1027)} \ln(\ln(n)) - 0.1674_{(0.0075)} av \cdot \ln stn - 0.0110_{(0.0009)} av \cdot temp$$

$$+ 0.2041_{(0.0097)} av \cdot rs4s50 - 0.0237_{(0.0076)} av \cdot \ln(\ln(n)) - 0.0786_{(0.0030)} \ln stn \cdot temp$$

$$- 1.5698_{(0.1303)} \ln stn \cdot rs4s50 - 1.3200_{(0.0701)} \ln stn \cdot m200 - 0.2416_{(0.0262)} temp \cdot rs4s50$$

$$- 0.1082_{(0.0129)} temp \cdot m200 - 0.0534_{(0.0036)} temp \cdot \ln(\ln(n))$$

$$R^2 = 0.83$$

For the fine and fine-plus gradations:

$$E(\ln(-\ln(SR))) = -55.4911_{(4.2948)} + 7.0102_{(0.5779)} ac + 0.6083_{(0.0558)} av + 0.4755_{(0.0922)} temp - 1.3899_{(0.3329)} \ln stn$$

$$+ 7.0609_{(1.0012)} rs4s50 + 0.9143_{(0.2540)} m200 + 8.0053_{(0.4530)} \ln(\ln(n)) - 0.0528_{(0.0027)} ac \cdot av$$

$$- 0.0753_{(0.0035)} ac \cdot temp + 0.1186_{(0.0214)} ac \cdot \ln stn - 1.0103_{(0.1395)} ac \cdot rs4s50$$

$$- 0.2657_{(0.0292)} ac \cdot m200 + 0.0908_{(0.0241)} ac \cdot \ln(\ln(n)) - 0.0045_{(0.0003)} av \cdot temp$$

$$+ 0.0177_{(0.0040)} av \cdot \ln stn - 0.0266_{(0.0111)} av \cdot rs4s50 - 0.0057_{(0.0026)} av \cdot m200$$

$$+ 0.0340_{(0.0045)} av \cdot \ln(\ln(n)) - 0.0776_{(0.0017)} temp \cdot \ln stn - 0.1069_{(0.0169)} temp \cdot rs4s50$$

$$- 0.0296_{(0.0054)} temp \cdot m200 - 0.0661_{(0.0019)} temp \cdot \ln(\ln(n)) + 0.4191_{(0.0705)} \ln stn \cdot rs4s50$$

$$+ 0.1871_{(0.0192)} \ln stn \cdot m200 + 0.5835_{(0.0307)} \ln stn \cdot \ln(\ln(n)) + 0.8220_{(0.0329)} rs4s50 \cdot m200$$

$$+ 0.2449_{(0.0879)} rs4s50 \cdot \ln(\ln(n)) + 0.1018_{(0.0230)} m200 \cdot \ln(\ln(n))$$

$$R^2 = 0.91$$

7.1.3.5 *Traffic file*

Please refer to Appendix E for the details of input format. The traffic file contains the hourly magnitude and wander positions of trafficking, from 3/3/96 to 9/3/98, for a total of 21,943 hours.

7.1.3.6 *Environment and material file*

The input format of the environment and material file is described in Appendix E. It contains the information of material properties, such as *av*, *ac*, *vma*, *rs4s50*, and *m200*, and the environmental variables, such as temperature at the bottom of asphalt concrete layer, the temperature gradient, and the stiffness of base and subgrade. The duration of the file is the same as that of the traffic file. The material properties of the Weibull simulation are listed in Table 7.1.

7.1.3.7 *Correction factor*

The correction factor that adjusts for the difference of boundary conditions between laboratory and field is assumed to be 1.0, for there is no way to confirm this factor from the WesTrack data. The effect of the correction factor on fatigue performance predictions will be discussed later in this chapter.

7.1.4 Failure Criterion

Conventionally, the fatigue life in the laboratory fatigue test is defined as the number of repetitions at the time when the stiffness reaches its 50 percent reduction. It is also believed that the distinguishable macrocrack might initiate at this moment based on the experience of conducting the fatigue tests and according to the SHRP fatigue report A404 (Tayebali 1994).

Table 7.1 Mix Properties of the WesTrack Project as the Input of Weibull Simulation

Type of Gradation	Section No.	AC	AV	VMA	RS4S50	M200
Coarse	5	5.63	8.1	12.80	3.63	6.10
	6	5.71	10.8	13.15	3.61	5.85
	7	6.49	6.9	12.95	3.60	5.90
	8	5.47	8.5	13.50	3.71	6.20
	23	5.79	4.9	13.05	3.63	6.30
	24	5.94	7.2	13.05	3.61	6.05
	25	6.55	3.7	12.90	3.57	6.15
	26	5.31	11.0	13.45	3.68	5.80
Fine	1	5.55	8.8	13.35	3.05	4.60
	2	4.92	10.4	13.85	3.19	4.60
	3	4.97	12.4	13.95	3.26	4.65
	4	5.12	6.6	14.05	3.25	4.35
	14	6.05	9.0	13.55	3.21	4.70
	15	5.42	8.7	13.75	3.09	4.95
	16	4.75	12.2	14.05	3.19	4.65
	17	5.74	11.0	13.90	3.28	4.85
	18	6.04	4.3	13.35	3.16	4.80
Fine plus	9	6.56	3.9	12.35	3.00	5.70
	10	5.28	11.8	12.45	2.95	5.40
	11	5.99	7.9	11.85	3.02	6.00
	12	5.84	4.6	11.85	3.01	5.70
	13	6.51	5.9	11.90	3.00	5.60
	19	5.89	7.2	11.90	2.94	5.75
	20	5.88	10.9	11.90	3.01	5.15
	21	6.75	4.2	12.00	2.85	5.35
	22	5.23	8.1	12.50	3.08	5.10

The main goal of using the dynamic approach of Weibull is to determine the crack initiation time of a crack forming from the bottom up to the surface of an asphalt concrete pavement. Since the outcome of the Weibull approach can be expressed with a two-dimensional stiffness ratio image-and-contour plot, it makes it possible to identify the location and time of crack initiation, if the failure criterion is defined as the stiffness ratio reaching 0.5.

7.1.5 Stiffness, Temperature, and Stiffness Ratio

In this Weibull approach, the stiffness ratio is used as an index of fatigue damage. Once the stiffness ratio reaches a certain level, it is said that the crack initiation will occur. The assumption postulated in this Weibull approach is that the fatigue damage of asphalt concrete cannot be recovered once damaged. However, keep in mind that the stiffness ratio is defined as $S(n, \underline{X}, T)/S(0, \underline{X}, T)$, where $S(n, \underline{X}, T)$ is the stiffness of asphalt concrete with mix properties \underline{X} at loading repetition n subjected to temperature T ; when n equals zero means the initial stiffness at temperature T .

It has been identified that temperature affects the stiffness of asphalt concrete. The asphalt concrete loses stiffness at higher temperatures and conversely gains strength when the temperature cools down. Thus both temperature and stiffness varies with time, and the value of stiffness is a relative quantity rather than an absolute one. The Weibull approach utilizes, instead of an absolute stiffness, the stiffness ratio. But, in the calculation of tensile strain, the ELSYM5 program needs an absolute stiffness as an input. To solve this discrepancy, an algorithm needs to be provided to take into account not only the temperature variation but also the stiffness deterioration. It is important to note that this algorithm must be developed maintaining the first assumption above.

Figure 7.6 will be used to demonstrate the relationship between stiffness ratio and initial stiffness. Two stiffness deterioration curves of laboratory fatigue tests with the same mix are shown in this figure. One is the $S^*(n, \underline{X}, T_2)$ curve at temperature T_2 and the other is the $S(n, \underline{X}, T_1)$ curve at temperature T_1 . Now, if the fatigue test starts at the $S(n, \underline{X}, T_1)$ curve and stops after n_1 applications, then the stiffness ratio will decrease from 1.0 to, say, R_1 . Afterward, if the temperature changes from T_1 to T_2 , then the stiffness will jump from $S(n, \underline{X}, T_1)$ to $S^*(n, \underline{X}, T_2)$. However, before any loading is applied, the stiffness ratio is assumed to maintain at R_1 , that is, the stiffness $S^*(n_1, \underline{X}, T_2)$ equals to $S^*(0, \underline{X}, T_2) \cdot R_1$. Notice that $\Delta S = S^*(n_2, \underline{X}, T_2) - S^*(n_1, \underline{X}, T_2)$. When this equation is divided by $S^*(0, \underline{X}, T_2)$, the difference of stiffness ratio ($\Delta R_{1 \rightarrow 2}$) along the $S^*(n, \underline{X}, T_2)$ curve after applying $n_2 - n_1$ loading repetitions is obtained. Hence, at loading repetition n_2 , the stiffness ratio will be $R_2 = R_1 + \Delta R_{1 \rightarrow 2}$. One thing should be pointed out: most of time the conventional stiffness equation obtained from laboratory fatigue tests is meant to be the “initial stiffness,” defined as the stiffness at repetition 50 and a function of either material or environmental variables. In the Weibull program, the stiffness at any loading repetition and any temperature will be calculated based on the present stiffness ratio and the conventional initial stiffness regression equation described above.

7.1.6 Stiffness as an Input

One of the drawbacks of utilizing the linear layered-elastic program is that it can only input one stiffness value to represent the stiffness of the entire layer. This ignores the fact that, because of distance from the load, temperature, or the wander effect, the strains experienced in

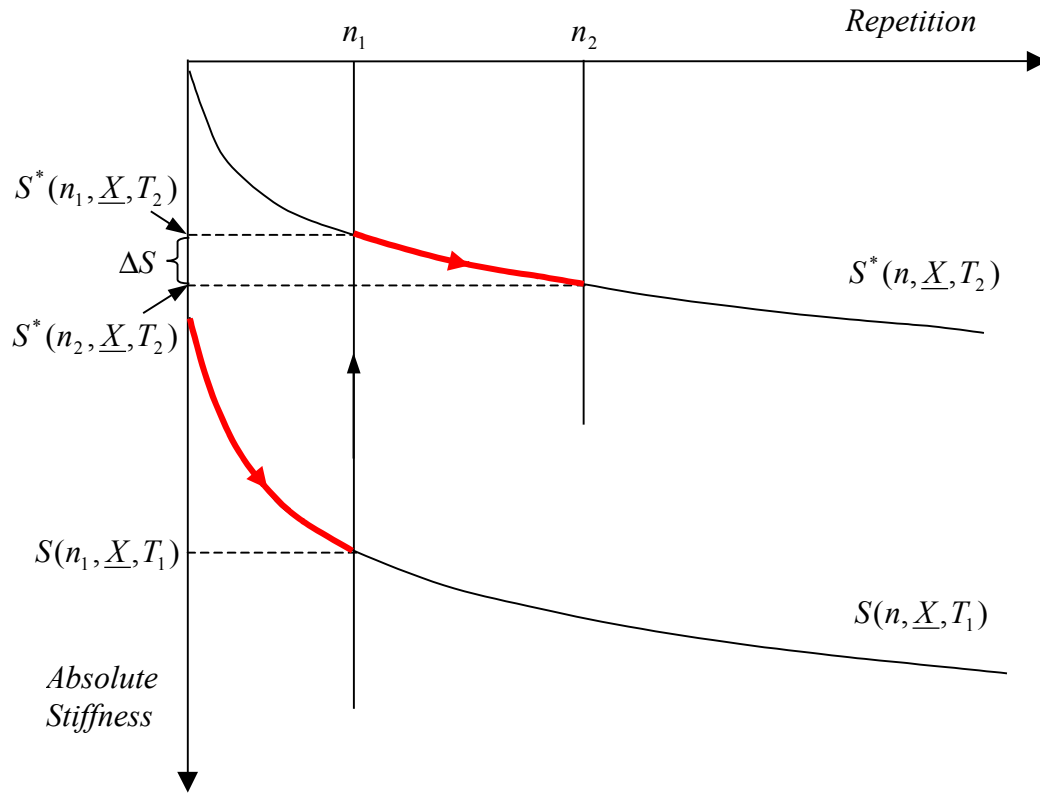

Figure 7.6. Relationship between initial stiffness and stiffness ratio.

the layer are varied point by point. Consequently, the stiffness deterioration should be diverse point by point as well. To mend this inconsistency, it was decided to use the average strains in one layer to calculate the stiffness deterioration for the Weibull regression equation and then to convert the stiffness ratio into stiffness based on the stiffness equation. The stiffnesses obtained were input for the next loading cycle. In sum, the Weibull program is compromised because of the restrictions of the linear layered-elastic program. However, instead of using the minimum strain or the maximum strain to calculate the input stiffness, the mean strain utilized here should be more statistically appropriate.

7.1.7 Wander Consideration

Instead of having channelized traffic, the wander distribution of tires on a highway cross section is distributed normally. For a specified position at the bottom of asphalt concrete layer, the tensile strain encountered will vary with time and wander position. The difference in fatigue damage that is accumulated due to the various strains encountered, compared with the constant strain of the no-wander case, is therefore termed as the “wander effect.”

The effect of wander on the fatigue performance is significant, as has already been demonstrated in the discussion in Chapter 6 utilizing the Miner’s law. However, without considering the stiffness deterioration of the pavement itself and including high temperature fatigue information, it seems the Miner’s approach is too conservative. That is to say, the correction factor for wander, defined as the ratio of repetitions of no-wander divided by repetitions of wander, tends to be too high. Thus, it is advantageous to further extend the definition of the correction factor of wander effect in the following way:

Definition: wander effect

For two given associated stiffness deterioration curves and a specific SR, the wander effect will be measured with the magnitude of the correction factor of wander that is

defined as $\phi_w = \frac{N_{wander}}{N_{no\ wander}}$, where N_{wander} is the repetitions at the specific SR of wander

curve; $N_{no\ wander}$ the repetitions at the specific SR of no wander curve.

The term “associated” in this definition means that the stiffness deterioration curves are calculated for the same location in the pavement structure for comparison. For the simulations of WesTrack, the location was chosen as the weakest point of the no-wander case after the whole simulation.

The *Weibull* program will take traffic and wander as input along with the other input files and compute the stiffness ratios both for the wander and no-wander cases. The way to calculate the tensile strain due to the wander at a specified position has already been illustrated in Figure 6.18 in Chapter 6.

7.1.8 Vehicle Speed and Stiffness

The frequency sweep test is utilized to define the master curves of the material of interest, especially an assumed thermorheologically simple material such as asphalt concrete. A typical result from the frequency sweep test is schematically shown in Figure 4.28, which illustrates the relationship between loading frequency (or loading time) and complex moduli at various reference temperatures. Thus, for a specific asphalt mix, the complex modulus depends not only on the temperature but also on the loading time. On highways, the various vehicle speeds will result in different loading times on the asphalt pavement; accordingly, the asphalt pavement will respond differently in stiffness, if temperature remains unchanged.

As shown in Figure 4.28, loading time or frequency and the stiffness of asphalt concrete exhibit a nonlinear relationship, which is characteristic of a viscoelastic material. This nonlinear relationship seems to be appropriately described by the Gamma function presented in Chapter 4.9.2. Note that these complex moduli could be regarded as the initial stiffness without any consideration of deterioration due to traffic loading because the curves were from the nondestructive frequency sweep test. Once the initial stiffness was represented by the material variables, temperature, and loading time (i.e., vehicle speed which, can be fit using a gamma distribution as discussed in Chapter 4.9.2), the same issue arose as discussed in Chapter 7.1.5: initial stiffness versus stiffness ratio and its affect on the fatigue performance of asphalt concrete. In this study, the effect of loading time (or vehicle speed) is not corrected during the simulation.

7.1.9 Traffic Wander, Traffic Composition, and Vehicle Speed

The traffic encountered on a highway, which includes many types of trucks, many tire configurations, and varying speeds over its service life, has randomness as its chief characteristic. The traffic features most related to the design of pavement, in general, are traffic wander, traffic composition (including truck type, tire configuration, tire pressure, etc.), and vehicle speed. The Weibull dynamic approach introduced in this study improves the prediction of the fatigue performance in a step-by-step recursive way and makes it possible to integrate the traffic characteristics into the simulation. The details of constructing a random sequence of traffic are demonstrated in Appendix E: *The Weibull User's Manual*. However, generating a random pattern of traffic is not included in this version of *Weibull* program, since the main goal of this study is to attempt to reproduce by analytical means the phenomenon observed in WesTrack.

7.2 Simulation Results of WesTrack

For this version of the *Weibull* program, the stiffness deterioration history of every point described in the ELSYM5 input file is monitored. Figure 7.7 gives a wander example of all the stiffness deterioration curves arranged in various depths at different offsets of Section 3. As seen in this figure, at offsets of 8, 9, 10, and 19 inches, more stiffness deterioration has accumulated at a depth of 1 inch than at a depth of 3 inches. This indicates that at those offsets the material experiences tensile strain on top of asphalt concrete layer and thus accumulates more fatigue damage. The *Weibull* program makes it possible to monitor the stiffness deterioration history of any point in pavement. Also note how the stiffness curves show rapid deterioration at the early trafficking stage and slowing thereafter.

The temperatures at the bottom of the asphalt concrete at WesTrack are plotted against the cumulative traffic in Figure 7.8a. The horizontal sections of the cumulative traffic curve indicate that no traffic has been applied during those time periods. The slope of the cumulative traffic curve represents the rate of cumulative traffic. The steeper the slope, the more traffic was applied. The weakest point of the wander case is located at an offset of 12 inches and a depth of 5.99 inches. Its stiffness deterioration curve is plotted with the cumulative traffic curve in Figure 7.8b. It should be noted that almost 30 percent of stiffness deduction occurs at the first two months which cover the temperatures from 0°C to 30°C. After this period, the rate of stiffness deterioration slows even if there is a combination of hot temperature and heavy trafficking.

The image-and-contour plots of SR of the 24 WesTrack sections (Sections 3 and 8 excluded) after 21,943 hours of simulation with wander and no wander are presented and attached in Appendix B from Figure B.7.1 through Figure B.7.24. Figures 7.9 and 7.10 display the image-and-contour plots of SR of Sections 3 and 8 respectively. For all the 26 test sections, the values of SR at the weakest points of the wander and no wander cases after simulation are listed in Table 7.2. Bear in mind that the simulations were conducted with a correction factor of 1.0.

For the WesTrack traffic pattern, the stiffness deterioration pattern at the bottom of the asphalt concrete layer seems to be no difference for the wander and no-wander cases no matter which mixes are used. By inspecting the stiffness deterioration curves of all 26 test sections at the weakest points of the no-wander cases, as seen in Figures 7.11 through 7.13, it was found that no obvious wander effects exist in the mixes of coarse gradation and only slight wander effects are observed in the mixes of fine and fine-plus gradations.

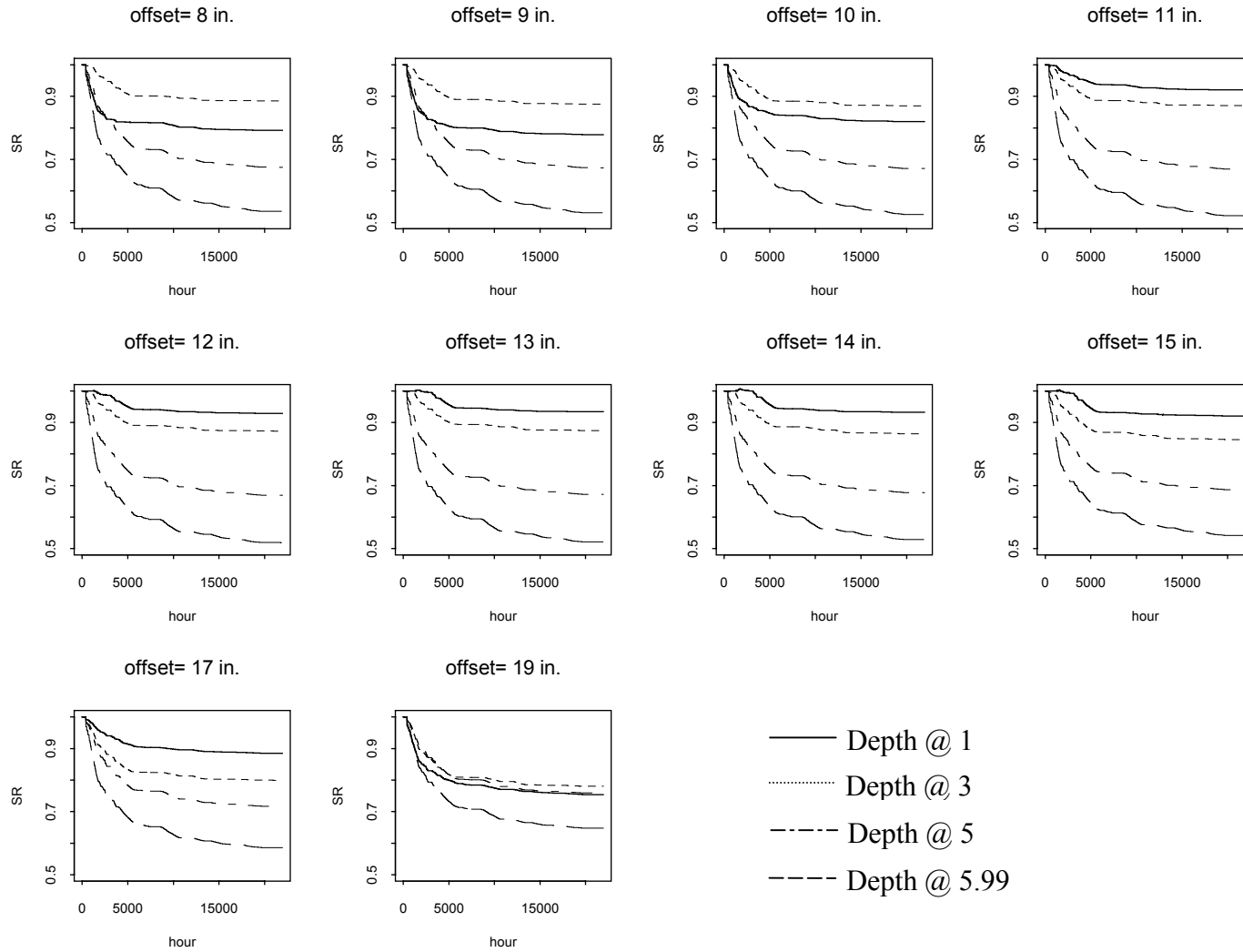
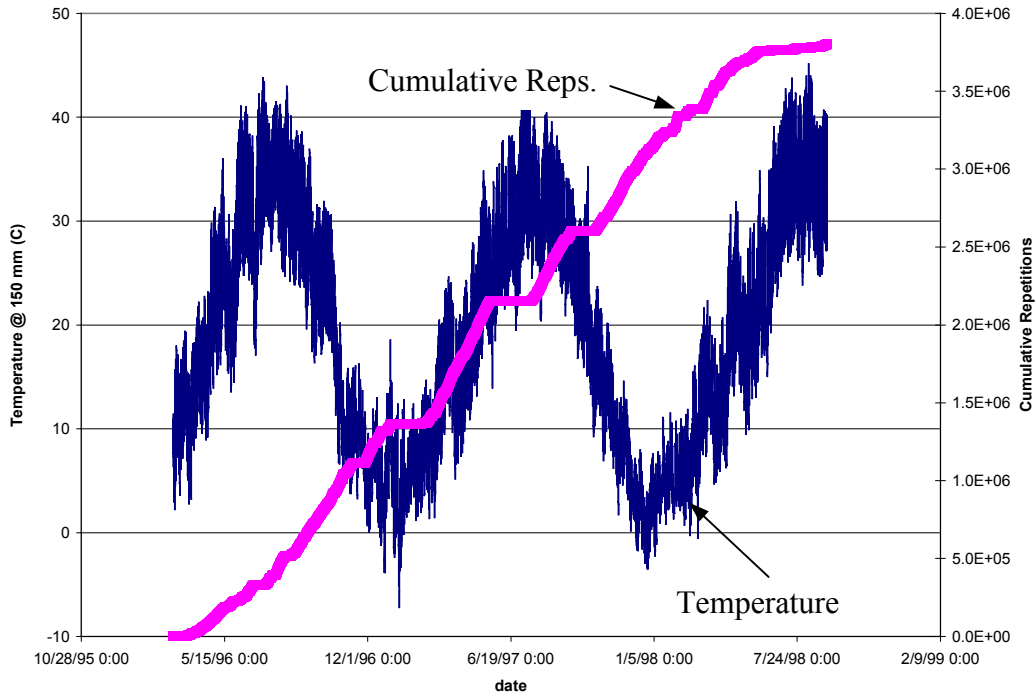
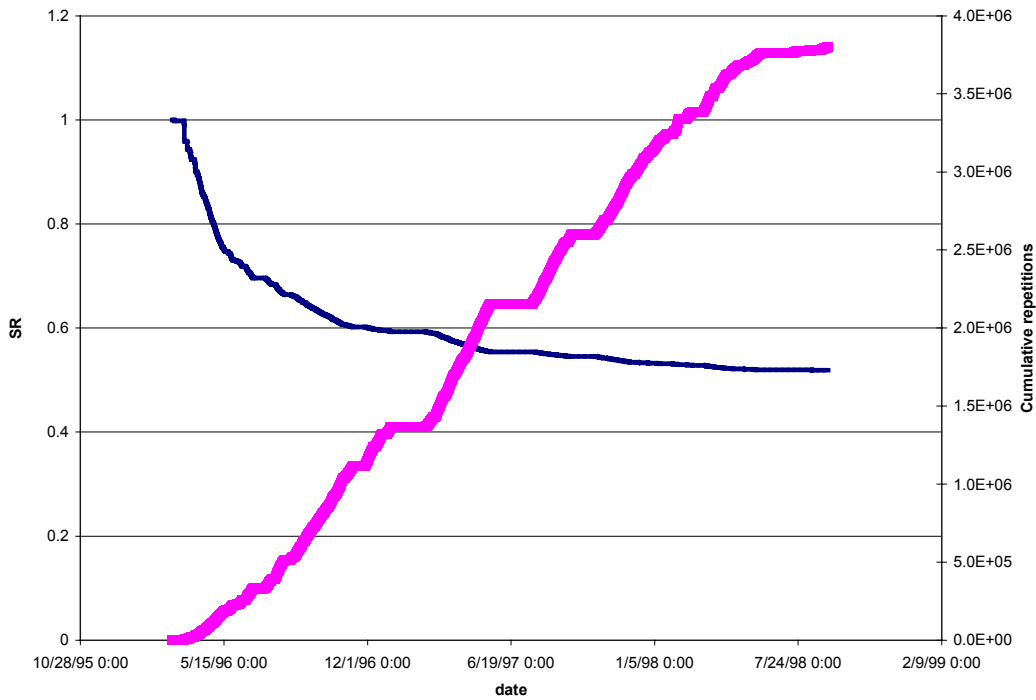

Figure 7.7. A wander example of stiffness deterioration curves arranged in various depths at different offsets of Section 3.



(a)



(b)

Figure 7.8. Stiffness deterioration of WesTrack section 3 and WesTrack traffic and environmental factors: (a) temperature and cumulative traffic and (b) stiffness deterioration and cumulative traffic.

section 3: fine, AC=4.97, AV=12.4, C.F.=1.0 (wander)

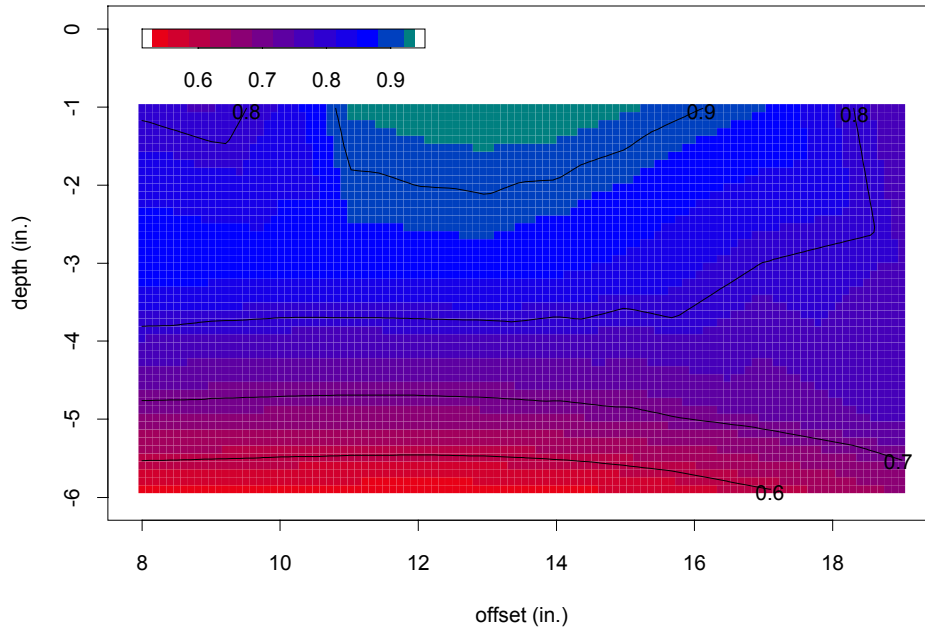

(a)

section 3: fine, AC=4.97, AV=12.4, C.F.=1.0 (no wander)

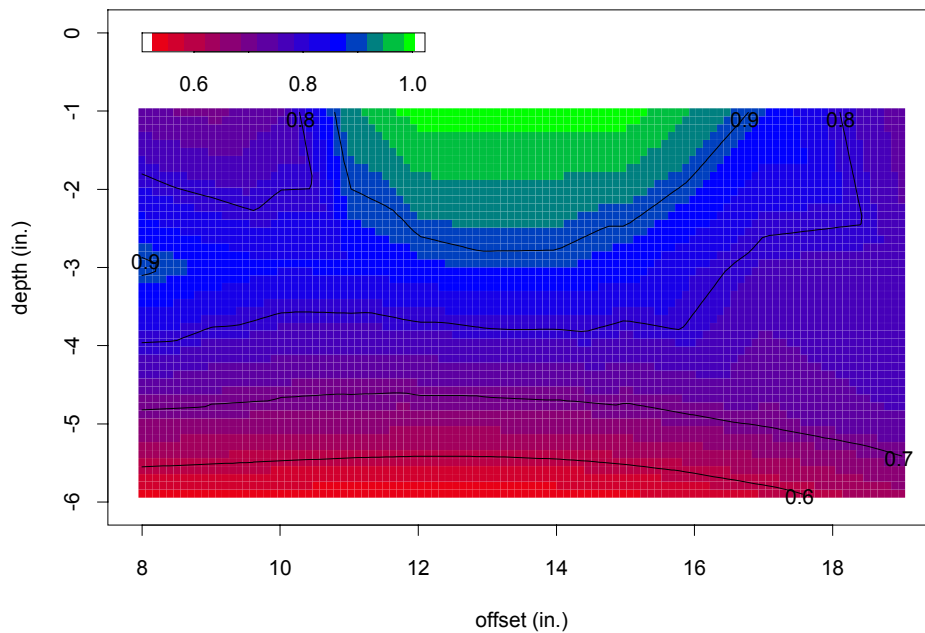

(b)

Figure 7.9. Image-and-contour plots of SR of WesTrack Section 3 after 21,943 hours of simulation with a correction factor of 1.0: (a) wander and (b) no wander.

section 8: coarse, AC=5.47, AV=8.5, C.F.=1.0 (wander)

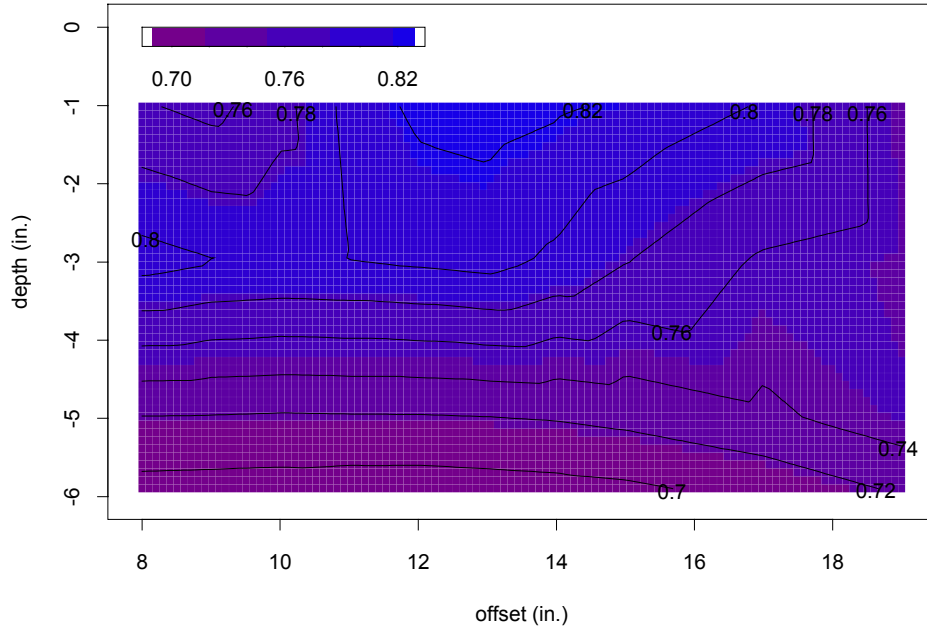

(a)

section 8: coarse, AC=5.47, AV=8.5, C.F.=1.0 (no wander)

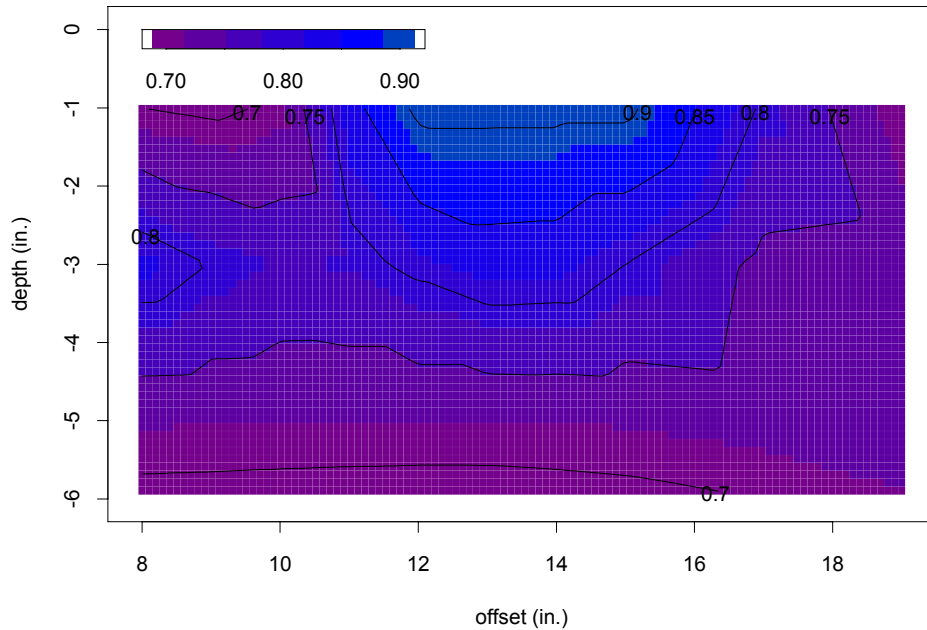

(b)

Figure 7.10. Image-and-contour plots of SR of WesTrack Section 8 after 21,943 hours of simulation with a correction factor of 1.0: (a) wander and (b) no wander.

Table 7.2 Final SR of Weibull Simulation of the WesTrack Project

Type of Gradation	Section No.	AC	AV	Wander		No wander	
				Offset (in.)	SR	Offset (in.)	SR
Coarse	5	5.63	8.1	11	0.7102	12	0.7068
	6	5.71	10.8	12	0.7029	12	0.6990
	7	6.49	6.9	12	0.7658	12	0.7641
	8	5.47	8.5	12	0.6884	12	0.6880
	23	5.79	4.9	11	0.7445	13	0.7411
	24	5.94	7.2	11	0.7388	12	0.7355
	25	6.55	3.7	12	0.7989	12	0.7989
	26	5.31	11.0	11	0.6994	12	0.6970
Fine	1	5.55	8.8	12	0.6276	12	0.6180
	2	4.92	10.4	12	0.6246	12	0.6197
	3	4.97	12.4	12	0.5190	12	0.5152
	4	5.12	6.6	11	0.7191	12	0.7128
	14	6.05	9.0	12	0.6003	12	0.5853
	15	5.42	8.7	12	0.6304	12	0.6208
	16	4.75	12.2	12	0.5881	12	0.5860
	17	5.74	11.0	12	0.5179	12	0.5024
Fine plus	18	6.04	4.3	11	0.7291	12	0.7198
	9	6.56	3.9	11	0.7512	12	0.7403
	10	5.28	11.8	12	0.5390	12	0.5301
	11	5.99	7.9	11	0.6729	12	0.6584
	12	5.84	4.6	11	0.7487	12	0.7395
	13	6.51	5.9	11	0.7016	12	0.6883
	19	5.89	7.2	11	0.6924	12	0.6802
	20	5.88	10.9	12	0.5300	13	0.5151
21	6.75	4.2	11	0.6850	12	0.6729	
22	5.23	8.1	12	0.6605	12	0.6524	

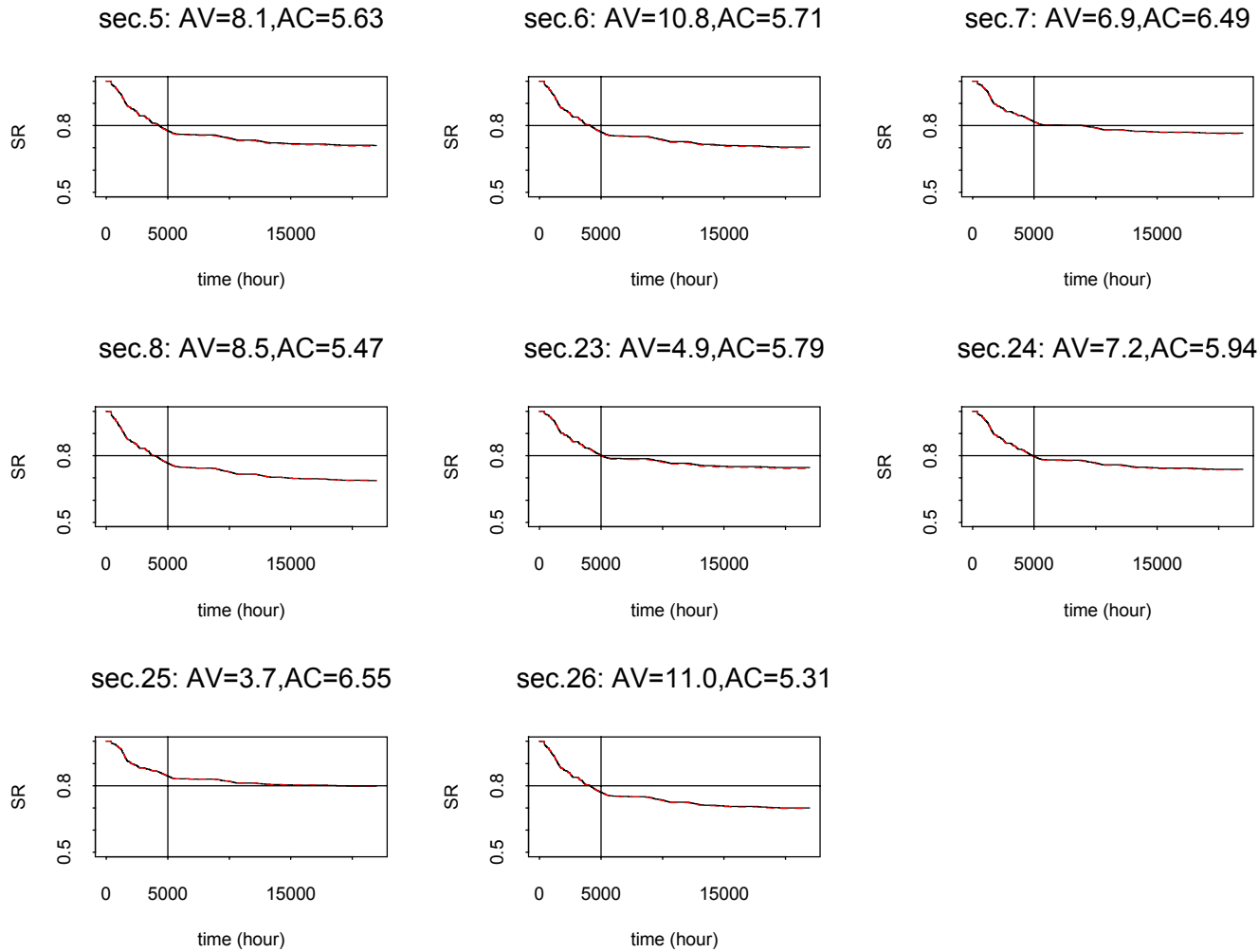

Figure 7.11. Stiffness deterioration curves of WesTrack coarse sections at a location of the weakest point of the no-wander case (wander case in solid line; no-wander case in dotted line).

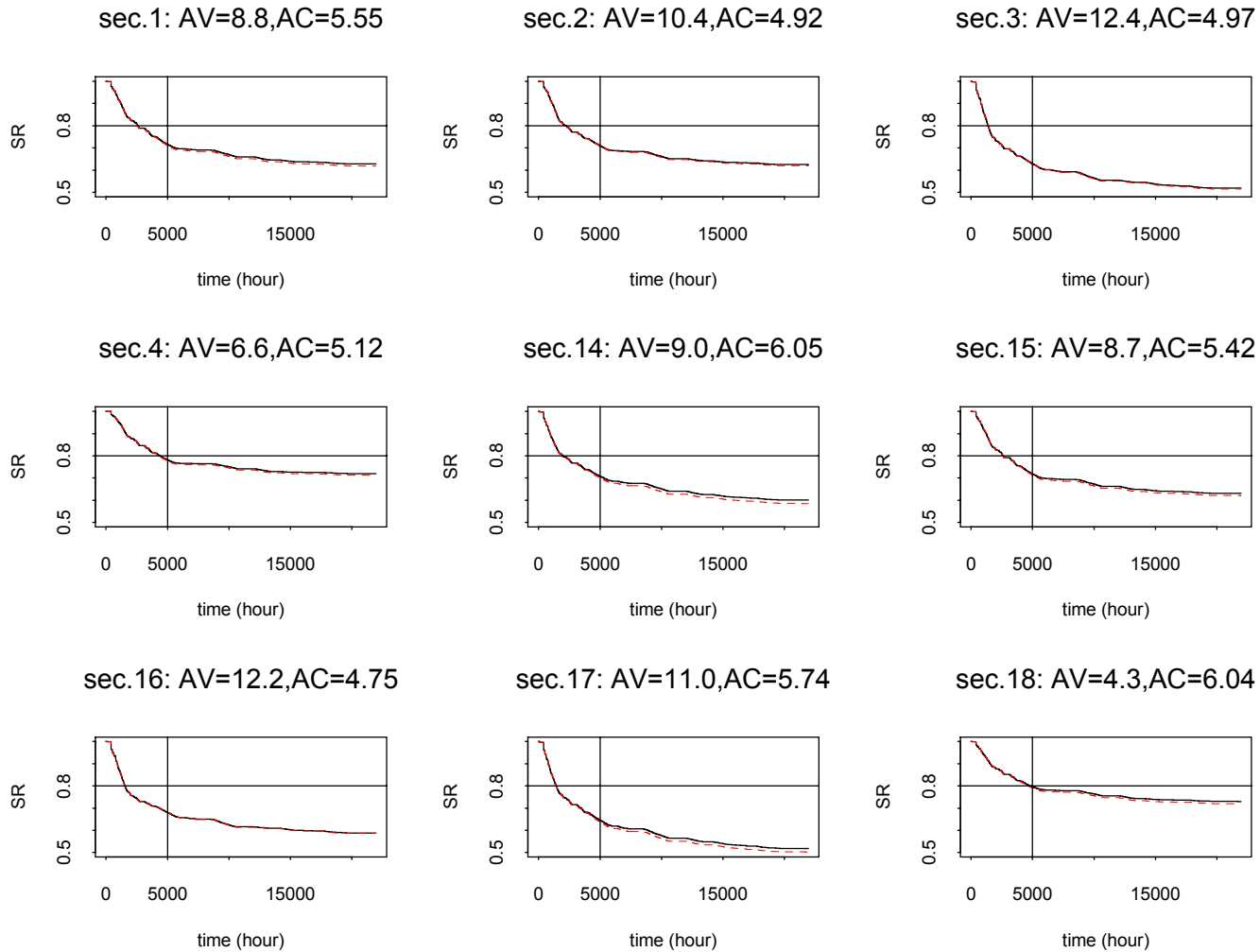

Figure 7.12. Stiffness deterioration curves of WesTrack fine sections at a location of the weakest point of the no-wander case (wander case in solid line; no-wander case in dotted line).

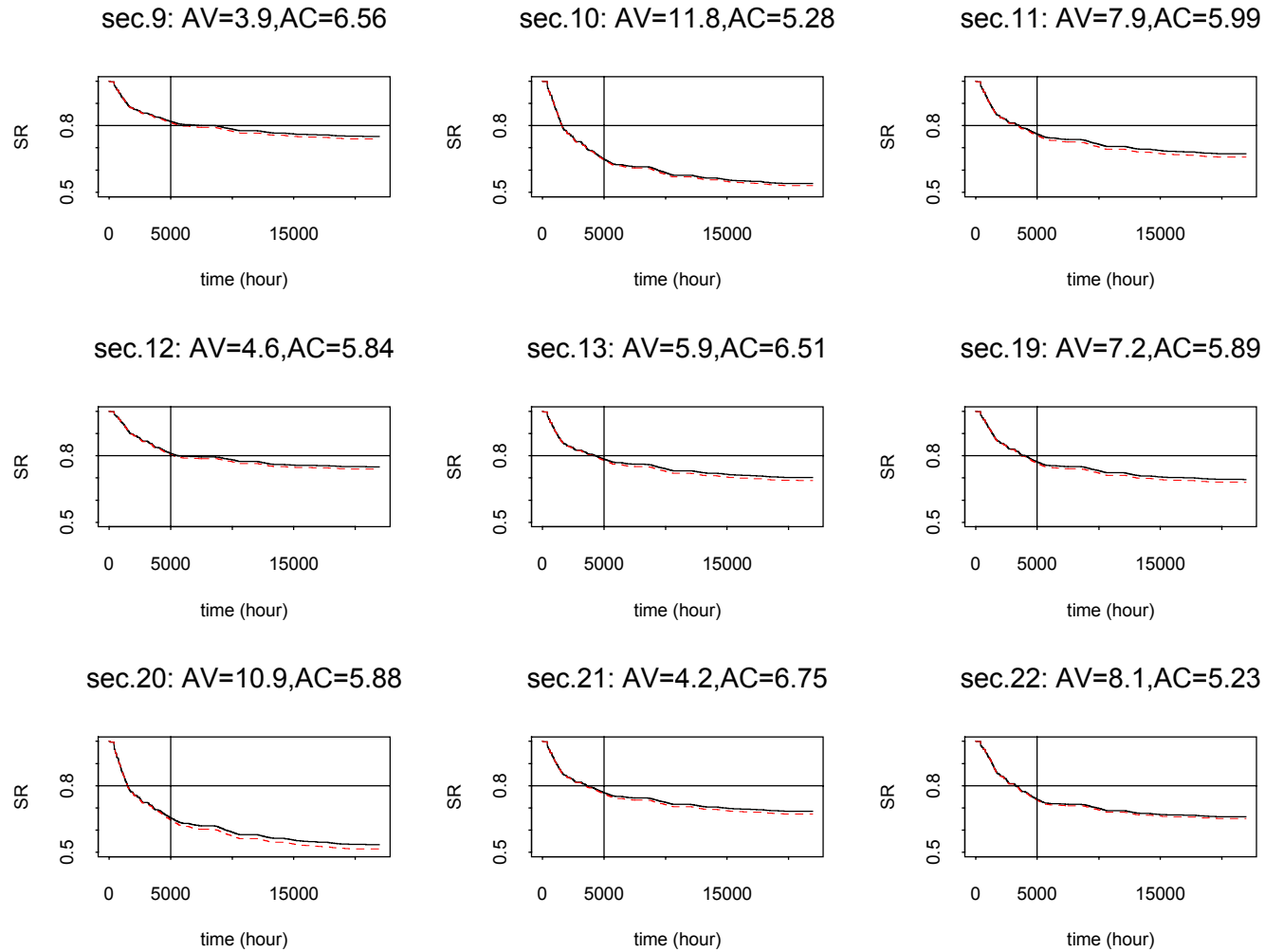

Figure 7.13. Stiffness deterioration curves of WesTrack fine-plus sections at a location of the weakest point of the no-wander case (wander case in solid line; no-wander case in dotted line).

This contradicts the results observed in Miner's approach of Chapter 6. The wander effect is hardly perceived; the correction factor for the wander effect, ϕ_w , is always greater than 1.0 and close to 1.0 for these simulations. This can also be seen in Table 7.2 where the final SR values of the wander cases are always higher than the values of the no-wander cases. As a weak inference, this suggests that traffic with wander will cause less fatigue damage than channelized traffic. It might be conjectured that, for the specific traffic pattern at WesTrack, the main reason for no obvious wander effect is because about one-tenth of traffic was applied at the central position (no-wander position), which resulted in no difference between wander and no-wander during the early service-life of the pavement when fatigue damage accumulates quickly whatever the environment and material factors.

Another interesting phenomenon is that the final stiffness deterioration patterns for the wander and no-wander cases for a given section look very similar. The only perceived difference is that less fatigue damage accumulated under the tire of the no-wander cases. When looking at the image-and-contour plots, something that should be in mind is that stiffness deterioration is caused by fatigue damage and the fatigue damage is caused by the tensile strain.

This phenomenon also gives indirect support to the proposed explanation of the lack of wander effect. Because the traffic was applied at the central position in the early service life of pavement, most of the fatigue damage was accumulated there and a stiffness deterioration pattern was set in place. The extra trafficking thereafter had less effect in determining the stiffness deterioration pattern.

The condition survey data of fatigue damage at the WesTrack project and the final SR deterioration results from Weibull simulation are listed in Table 7.3. In addition, the Table 7.3 also lists the date and hour when the SR reached 0.8 and 0.6. According to the condition survey

data and the SRs at 0.8 and 0.6, three figures were plotted to explore the relationship between the predictions and the condition survey. For the sections with the coarse gradation, several findings were observed:

1. As seen in Figure 7.14, the 10 percent fatigue cracking occurred only at the sections with air-void contents greater than 8.0 percent and at the first winter. The 50 percent fatigue cracking was developed quickly once the 10 percent fatigue cracking had been reached. It implies that the cold weather is an important factor in crack propagation. The Weibull simulation fails to describe the quick crack propagation during winter for the coarse mixes and the importance of including a crack propagation model in the Weibull simulation is clearly demonstrated.
2. The rankings of the simulation results for those sections with cracks, if one looks carefully at Table 7.3, is almost the same for those with 10 percent cracking and 50 percent cracking.

For the simulation results of SR, if 0.5 is the value set for the failure criterion, then none of the simulation results of SR show the failure. This indicates that a Weibull simulation without an additional model will not model the crack propagation phenomenon, especially during a cold winter. Although it can be argued that the simulation results of SR are capable of being modified by the correction factor, the prominent fact is that the lack of crack propagation model is a significant deficiency for the Weibull dynamic approach.

For the fine and fine-plus gradations (as illustrated in Figures 7.15 and 7.16), the observations can be summarized in the following:

Table 7.3 Condition Survey Data of Fatigue Cracking and Simulation Results

Type of Gradation	Sec. No.	AC (%)	AV (%)	10 % fatigue Cracking			50 % fatigue Cracking			SR = 0.8		SR = 0.6		Final SR (Wander)
				ESAL	Date	Hour	ESAL	Date	Hour	Date	Hour	Date	Hour	
Coarse	5	5.63	8.1	1,757,238	12/30/96	7,243 (4)	2,311,472	04/08/97	9,619 (4)	08/30/96	4,313	DNO	DNO	0.7102 (4)
	6	5.71	10.8	1,668,205	12/16/96	6,907 (3)	1,794,207	02/19/97	8,467 (3)	08/23/96	4,157	DNO	DNO	0.7029 (3)
	7	6.49	6.9	DNO	DNO	DNO	DNO	DNO	DNO	03/16/97	9,072	DNO	DNO	0.7658
	8	5.47	8.5	1,515,380	12/01/96	6,547 (2)	1,789,150	01/01/97	7,291 (2)	08/15/96	3,958	DNO	DNO	0.6884 (1)
	23	5.79	4.9	DNO	DNO	DNO	DNO	DNO	DNO	10/02/96	5,110	DNO	DNO	0.7445
	24	5.94	7.2	DNO	DNO	DNO	DNO	DNO	DNO	09/23/96	4,891	DNO	DNO	0.7388
	25	6.55	3.7	DNO	DNO	DNO	DNO	DNO	DNO	05/11/98	19,172	DNO	DNO	0.7989
	26	5.31	11.0	1,487,207	11/29/96	6,499 (1)	1,626,490	12/10/96	6,763 (1)	08/23/96	4,138	DNO	DNO	0.6994 (2)
Fine	1	5.55	8.8	DNO	DNO	DNO	DNO	DNO	DNO	06/19/96	2,591	DNO	DNO	0.6276
	2	4.92	10.4	2,899,176	07/26/97	12,235 (1)	DNO	DNO	DNO	06/04/96	2,225	DNO	DNO	0.6246 (4)
	3	4.97	12.4	3,585,531	11/05/97	14,683 (2)	4,340,103	02/18/98	17,203 (1)	04/30/96	1,391	12/02/96	6,580	0.5190 (2)
	4	5.12	6.6	DNO	DNO	DNO	DNO	DNO	DNO	09/01/96	4,370	DNO	DNO	0.7191
	14	6.05	9.0	DNO	DNO	DNO	DNO	DNO	DNO	05/24/96	1,972	DNO	DNO	0.6003
	15	5.42	8.7	DNO	DNO	DNO	DNO	DNO	DNO	06/20/96	2,615	DNO	DNO	0.6304
	16	4.75	12.2	3,720,800	11/17/97	14,971 (3)	DNO	DNO	DNO	05/06/96	1,527	12/11/97	15,548	0.5881 (3)
	17	5.74	11.0	4,227,572	01/18/98	16,459 (4)	DNO	DNO	DNO	05/02/96	1,436	03/09/97	8,901	0.5179 (1)
18	6.04	4.3	DNO	DNO	DNO	DNO	DNO	DNO	09/21/96	4,844	DNO	DNO	0.7291	
Fine plus	9	6.56	3.9	DNO	DNO	DNO	DNO	DNO	DNO	02/23/97	8,571	DNO	DNO	0.7512
	10	5.28	11.8	1,750,322	12/29/96	7,219 (1)	4,215,885	01/17/98	16,435 (1)	05/08/96	1,588	03/28/97	9,344	0.5390 (2)
	11	5.99	7.9	DNO	DNO	DNO	DNO	DNO	DNO	07/28/96	3,513	DNO	DNO	0.6729
	12	5.84	4.6	DNO	DNO	DNO	DNO	DNO	DNO	10/23/96	5,615	DNO	DNO	0.7487
	13	6.51	5.9	DNO	DNO	DNO	DNO	DNO	DNO	08/30/96	4,323	DNO	DNO	0.7016
	19	5.89	7.2	DNO	DNO	DNO	DNO	DNO	DNO	08/17/96	4,003	DNO	DNO	0.6924
	20	5.88	10.9	DNO	DNO	DNO	DNO	DNO	DNO	05/05/96	1,507	04/04/97	9,525	0.5300 (1)
	21	6.75	4.2	DNO	DNO	DNO	DNO	DNO	DNO	07/31/96	3,598	DNO	DNO	0.6850
22	5.23	8.1	DNO	DNO	DNO	DNO	DNO	DNO	07/17/96	3,256	DNO	DNO	0.6605	

Note: DNO: did not occur; the number in () indicates the ranking.

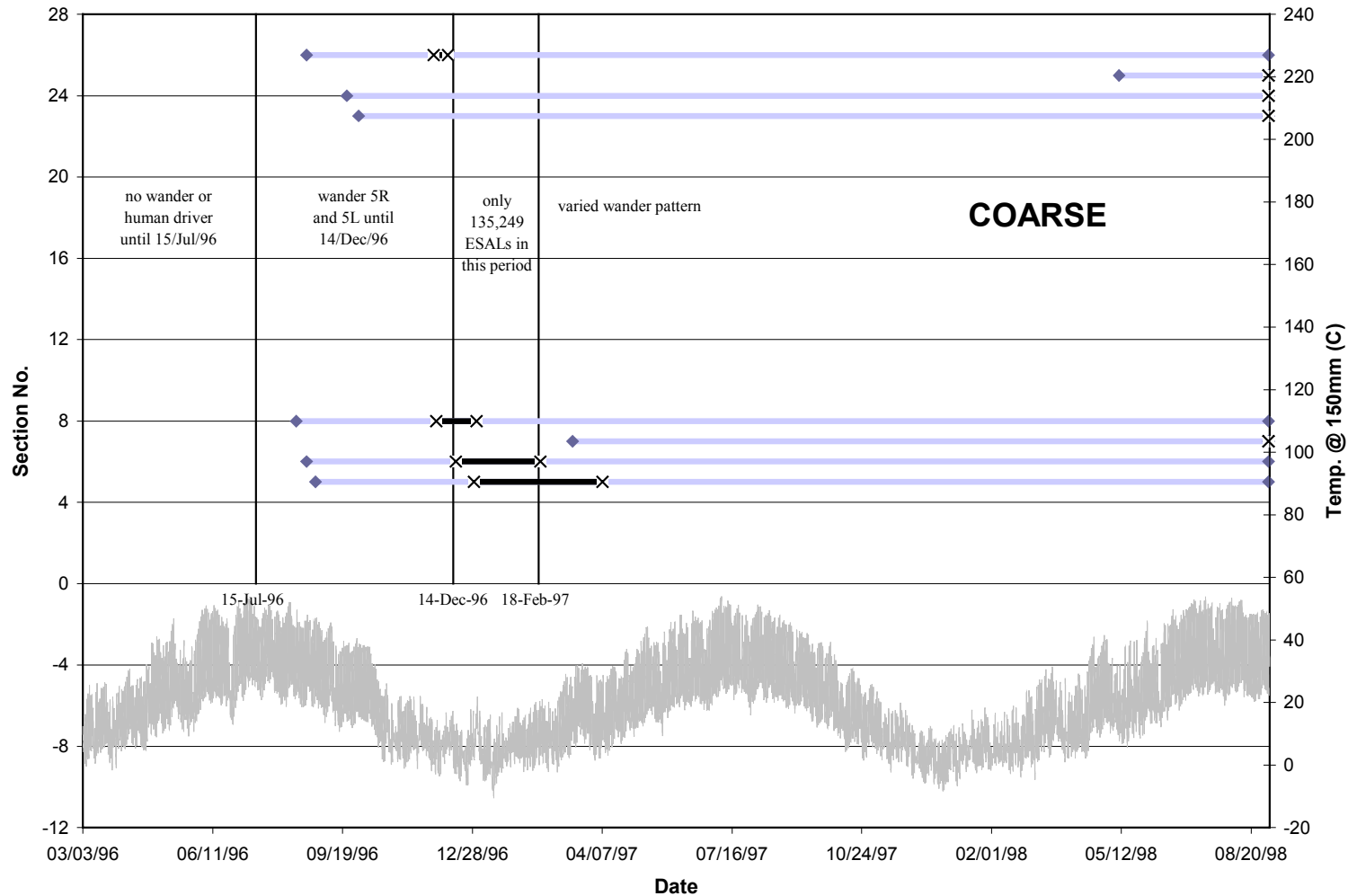

Figure 7.14. The Weibull simulation results and condition survey of coarse mixes of the WesTrack project (Note: left \blacklozenge represents the time of SR = 0.8; the right \blacklozenge means the time of SR = 0.6. The left \times means the time of 10 % fatigue cracking; the right \times is the time of 50 % fatigue cracking.).

1. The 10 percent fatigue cracking only occurred on the sections with air-void contents greater than 10 percent for both the fine and fine-plus gradations. A notable counterexample is fine-plus test section 20, which had a 10.9 percent air-void content but no cracking.
 2. The 10 percent fatigue cracking was observed at the second or the third year for the fine gradation but it occurred at the first winter for the fine-plus gradation. Notice that all the cracking sections had air-void contents greater than 10 percent.
 3. The 50 percent fatigue cracking only occurred at Sections 3 and 10 in the second winter.
 4. The ranking of the final SR values is not consistent with the ranking of the 10 percent and 50 percent cracking-development time.
1. The fine-plus gradation takes longer time to have the crack propagation to go from 10 percent cracking to 50 percent cracking as compared with the fine gradation.

These observations reinforce the importance of the incorporation of a crack propagation model. The mechanism of crack propagation is not so simple as the crack initiation. The crack propagation rate may be a complex function of temperature, traffic, material properties, and pavement structure.

In sum, the lessons that have been learned from this simulation are as follows:

1. The rate of stiffness deterioration is higher in the early trafficking stage and slows thereafter.
2. Fatigue damage accumulates quickly at the early stage of trafficking. Thus, long-term fatigue performance may be determined significantly by the temperature range

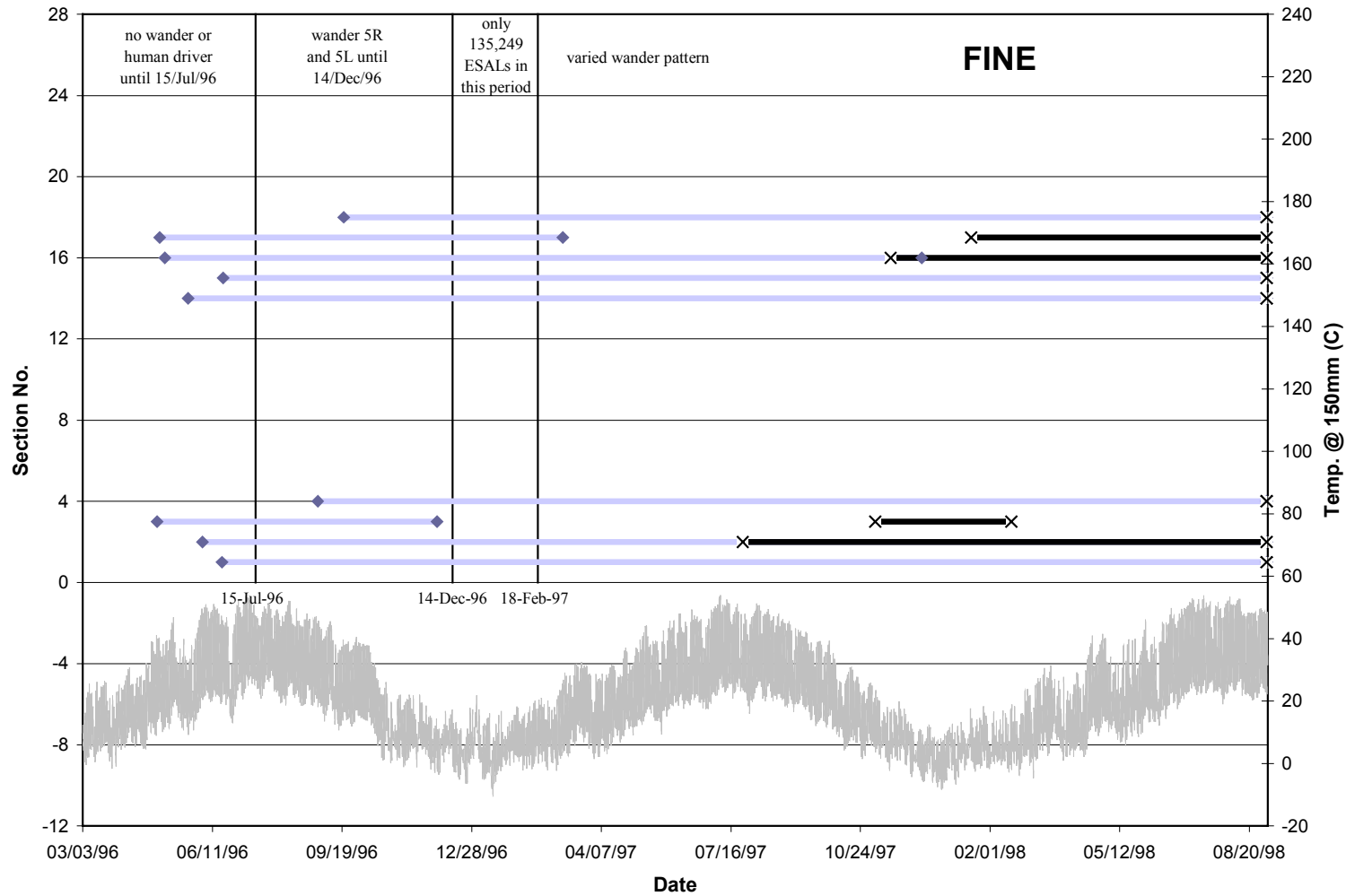

Figure 7.15. The Weibull simulation results and condition survey of fine mixes of the WesTrack project (Note: left ◆ represents the time of SR = 0.8; the right ◆ means the time of SR = 0.6. The left x means the time of 10 % fatigue cracking; the right x is the time of 50 % fatigue cracking.).

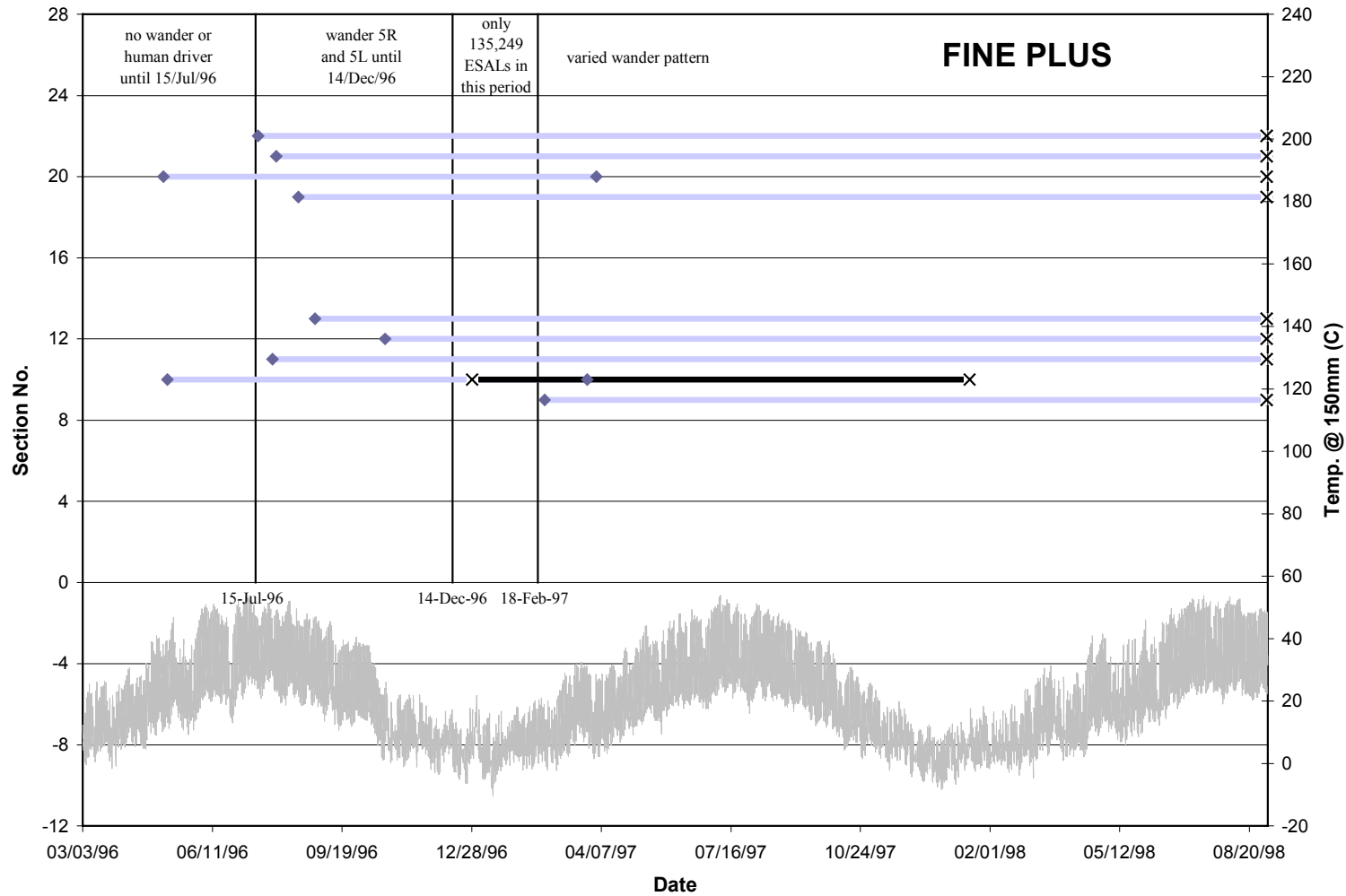

Figure 7.16. The Weibull simulation results and condition survey of fine-plus mixes of the WesTrack project (Note: left \blacklozenge represents the time of SR = 0.8; the right \blacklozenge means the time of SR = 0.6. The left x means the time of 10 % fatigue cracking; the right x is the time of 50 % fatigue cracking.).

3. and the pattern of trafficking in the early service life of the newly constructed pavement.
4. No obvious wander effect was observed for this specific WesTrack traffic pattern.
5. The Weibull simulation results are generally consistent with the condition survey data for the fatigue damage within the same gradation type.

It seems that the Weibull dynamic approach cannot capture the mechanism of surface cracking because the approach, for the time being, only includes the consideration of the crack initiation and excludes the crack propagation. From this simulation, it was recognized that a combination model of crack initiation and crack propagation should be seriously considered in the future.

Conclusions (1) and (2), although contradicted in beam tests, match well to, for example, Chapter 5.7.3 from the 503RF study.

7.3 Traffic Pattern and Simulation

The term “traffic pattern” might be seen elsewhere with different definitions. The definition the author uses herein is as follows:

A traffic application can be characterized by three variable elements: loading configuration, wander location, and vehicle speed. Where the total number of traffic applications remains constant for a fixed time interval, a “traffic pattern” will consist of sequentially ordered traffic applications with any combination of these three variable elements.

The term “modified traffic pattern” will be utilized along with “original traffic pattern” to emphasize the differences in loading sequences. To confirm the hypothesis in Chapter 7.2 that no wander effect is observed because the traffic was applied in the center position at the early service life of the pavement, two simulations with a correction factor of 1.0 were run at sections

3 and 8. From the laboratory fatigue tests, it is recognized that the stiffness deterioration curve accumulates the fatigue damage quickly in the early loading stage, especially for the tests with higher strain level. Thus, it is naturally inferred that the early traffic pattern applied on the pavement will control the damage rate of the pavement for the rest of its life.

To further explore this, a “modified traffic pattern” was formed by moving the data for the first 3,000 hours from the beginning to the end of the traffic file. The proportion of the traffic applications during this 3,000-hours period is about one tenth of the total applied traffic. For this case, the total applied traffic remains unchanged and the pavement will not experience channelized traffic at the beginning of its service life.

The results of the modified traffic pattern applied to the Section 3 final stiffness deterioration data are shown in Figures 7.17a and 7.17b for wander and no-wander cases. As compared with the results of original and modified traffic patterns, several observations of the final stiffness deterioration patterns of wander and no-wander cases can be summarized below:

1. In sum, the modified traffic pattern causes less deterioration of the asphalt concrete layer.
2. The SR values that occur at a 1-inch depth with wander seem to have a decreasing trend from left to right. However, the fatigue damage caused by original traffic pattern at this depth deteriorates more at the two far ends.
3. The modified traffic pattern created a very different pattern of stiffness deterioration with wander, as visualized in Figure 7.9a.

The difference that appeared in the no-wander cases, as seen in Figures 7.17b and 7.9b, is primarily in the degree of deterioration; the final stiffness deterioration patterns are similar.

Traffic effect: sec.3, AV=12.4, AC=4.97 (wander)

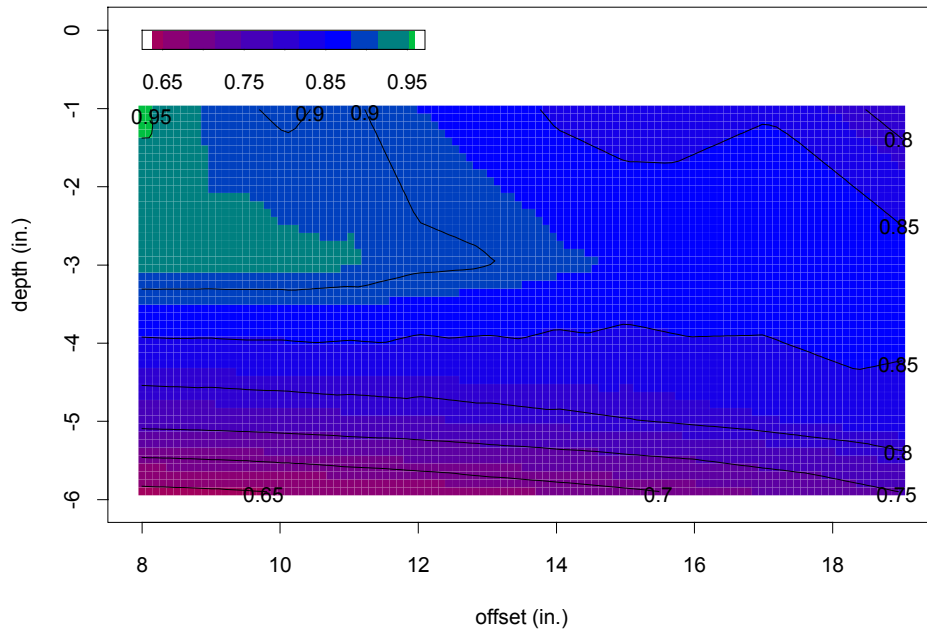

(a)

Traffic effect: sec.3, AV=12.4, AC=4.97 (no wander)

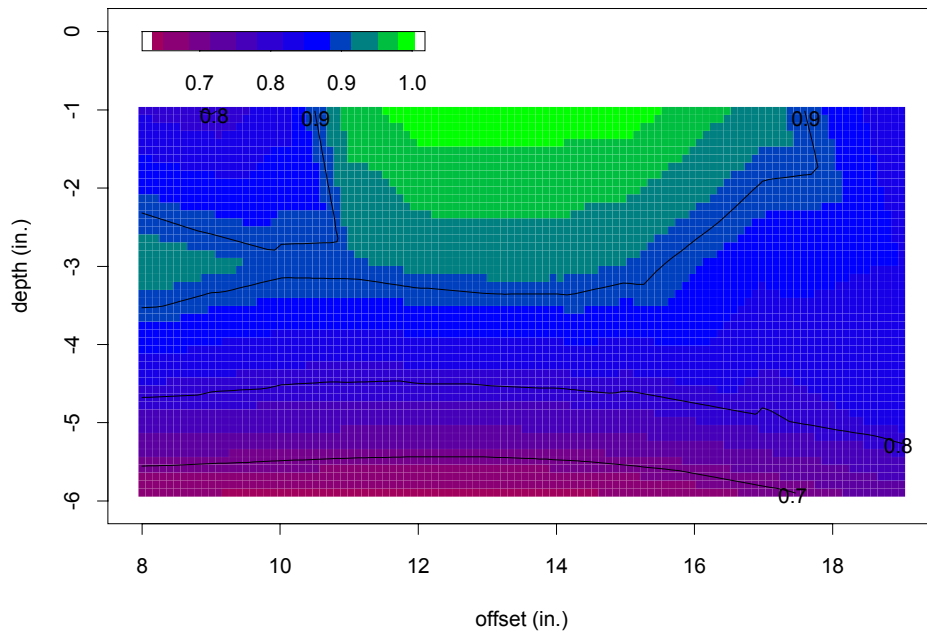

(b)

Figure 7.17. Image-and-contour plots of SR of WesTrack Section 3 with modified traffic pattern: (a) wander and (b) no wander.

Figure 7.18 presents the plot of SR against time at the location with an offset of 12 in. and depth of 5.99 in. This is the weakest point that occurs in a no-wander case subjected to the original traffic pattern. As can be clearly viewed in this figure, there is a wander effect under the modified traffic pattern. The stiffness deterioration curves also vary at the early trafficking stage for the original and modified traffic patterns.

The same conclusions obtained from test section 3 apply to test section 8. The stiffness deterioration patterns of final SR values, with wander and no-wander cases, are illustrated separately in Figure 7.19a and 7.19b. The only difference is that for the modified traffic pattern, no wander effect can be seen (Figure 7.20). In other words, the mix at test section 8 is insensitive to the wander effect of that traffic pattern.

Therefore, two general conclusions can be made from this simulation:

1. The traffic pattern will affect the stiffness deterioration curve and the final stiffness deterioration pattern.
2. The asphalt-aggregate mix can be either sensitive or insensitive to the wander effect caused by various traffic patterns.

Therefore, the hypothesis proposed at the beginning of this chapter—that no obvious wander effect is observed because a significant portion of the traffic was applied in the center position during the early service life of the pavement—has been supported through the application of a modified traffic pattern analysis.

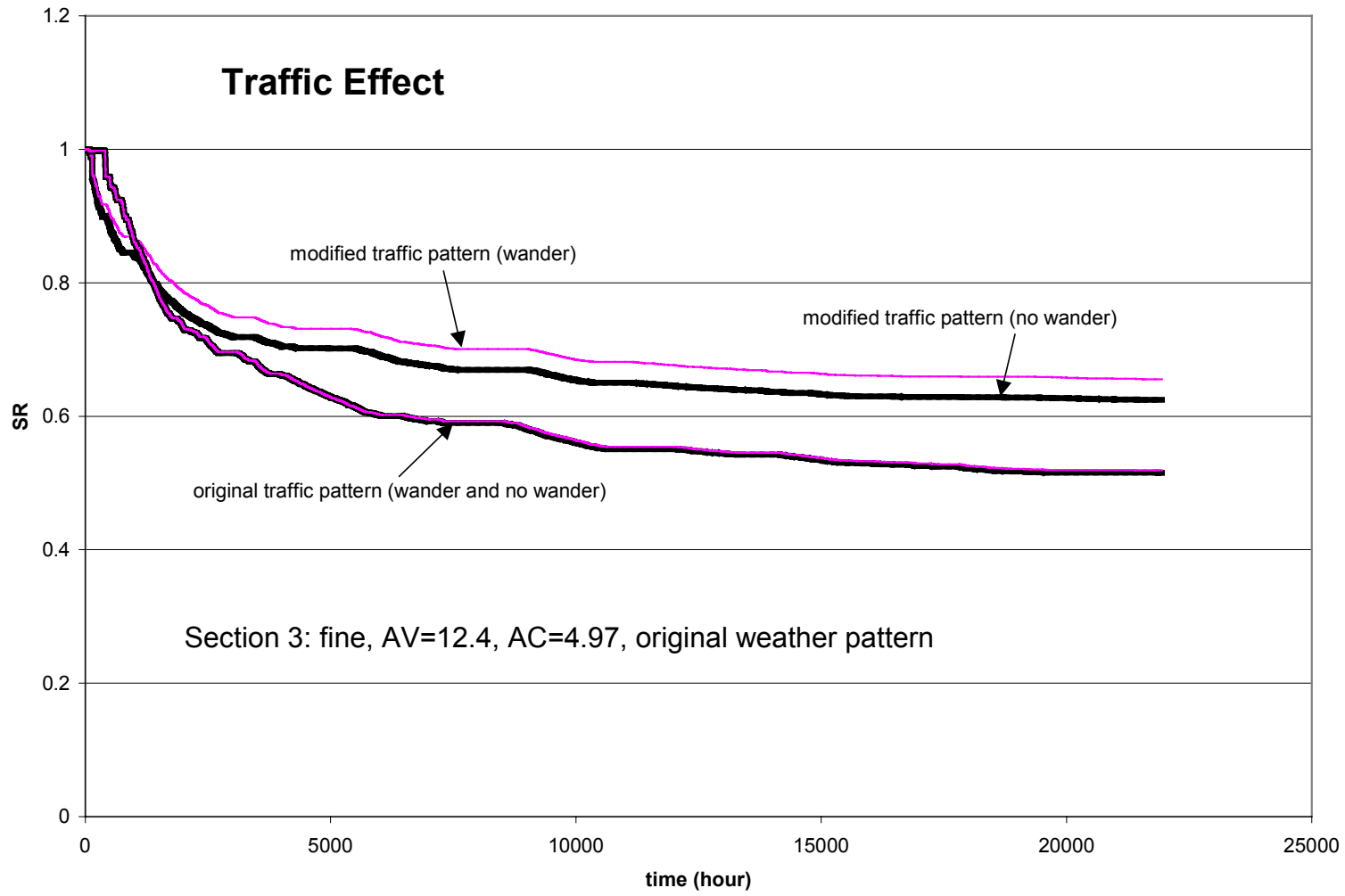
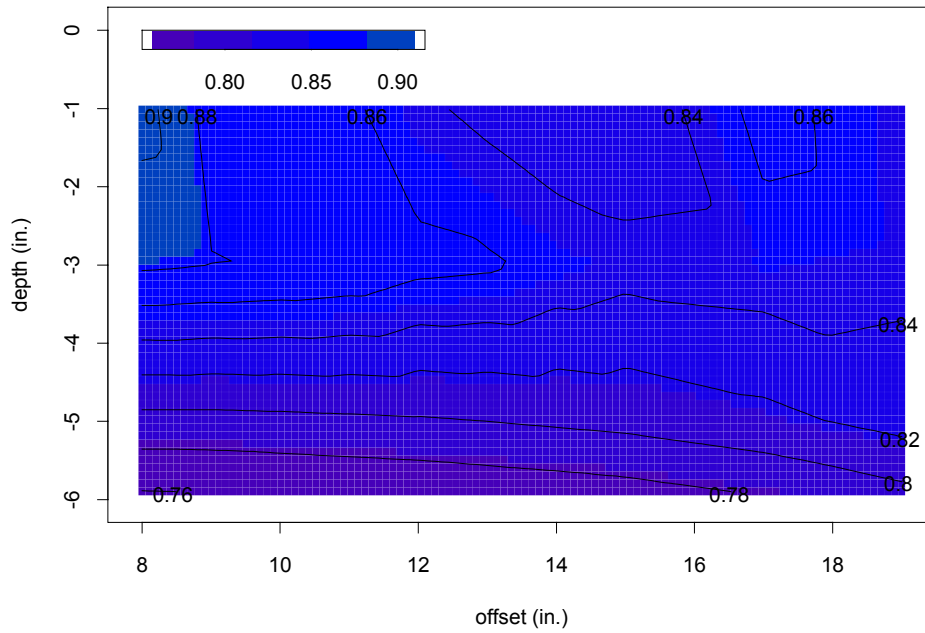

Figure 7.18. Stiffness deterioration curves of WesTrack Section 3 with modified traffic pattern.

Traffic effect: sec.8, AV=8.5, AC=5.47 (wander)



(a)

Traffic effect: sec.8, AV=8.5, AC=5.47 (no wander)

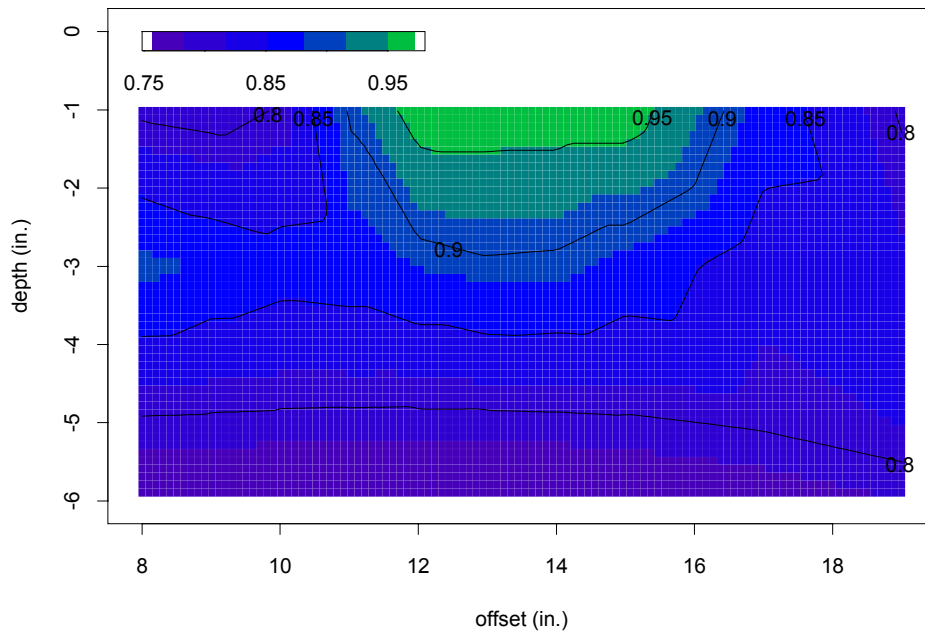

(b)

Figure 7.19. Image-and-contour plots of SR of WesTrack Section 8 with modified traffic pattern: (a) wander and (b) no wander.

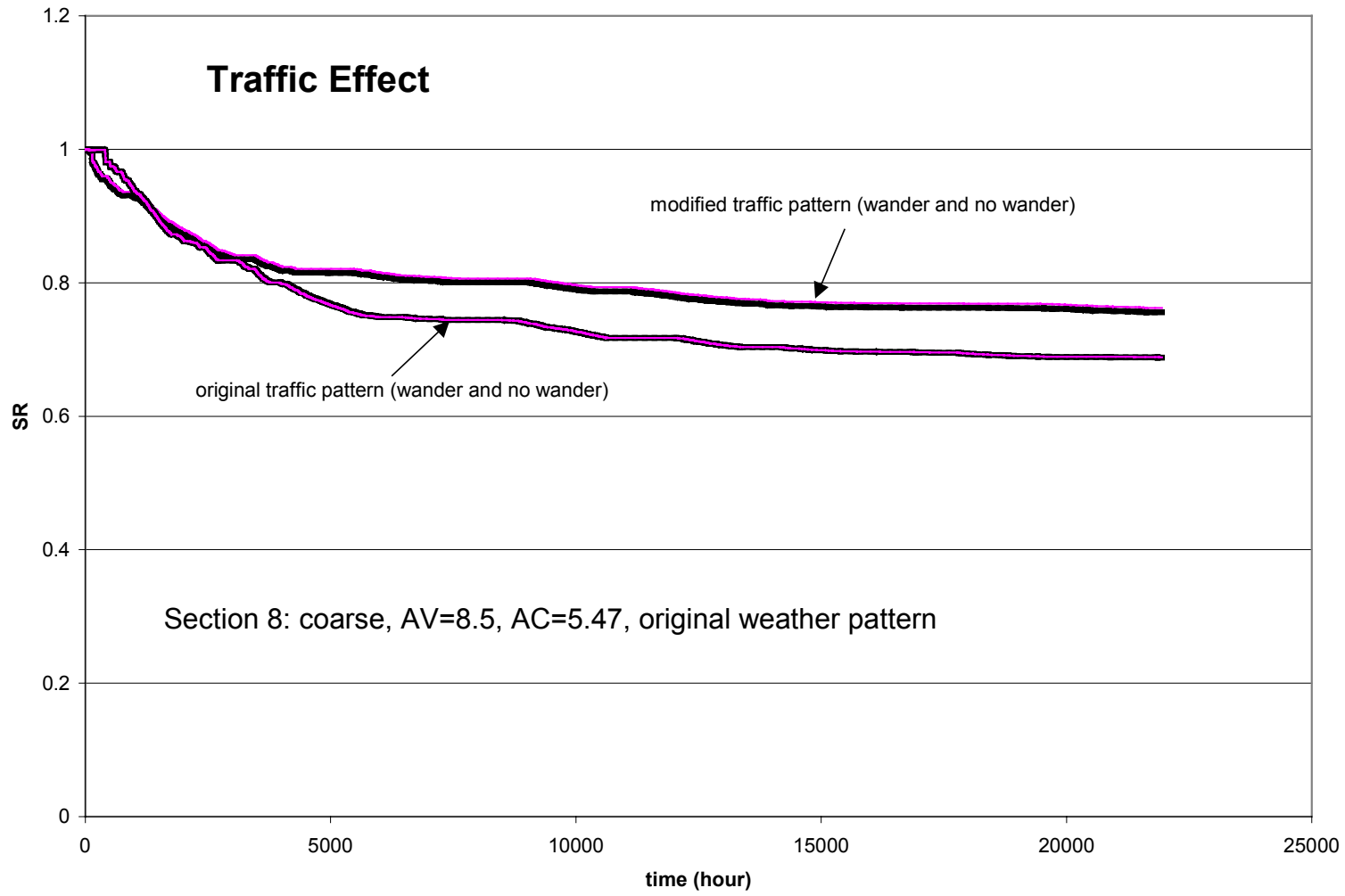

Figure 7.20. Stiffness deterioration curves of WesTrack Section 8 with modified traffic pattern.

7.4 Weather and Simulation

The fatigue test results of this study show that the stiffness deteriorates quickly at low to intermediate temperatures and that most fatigue damage accumulates during the early loading stage. Consequently, it is suspected that the start time of trafficking after the construction of a pavement is significantly associated with the fatigue performance over its life span for the two-year life span of WesTrack. To verify such a hypothesis, the original temperature spectrum of WesTrack was modified so that the traffic loading was presumed to start in the early summer. In doing so, the first 1,440 hours of temperature data (i.e., the first 2 months) was eliminated from the original temperature file. To utilize the full traffic load spectrum, those blank temperatures were supplied with the temperatures from the same dates in the previous year.

As previously, the simulations were applied to Section 3 (fine gradation) and the Section 8 (coarse gradation). The applied correction factor remained one. The original traffic pattern was utilized herein so as to verify the main effect of the weather pattern.

As discussed in the previous section, the traffic pattern will affect the final pavement deterioration pattern. For the original traffic pattern, the channelized traffic applied in the early service life of the pavement makes no obvious wander effect. Although the weather pattern has been modified, the final pavement deterioration patterns, as seen in Figures 7.21 and 7.23, still look quite similar for the wander and no-wander cases. It implies that the final pavement deterioration pattern is mainly determined by the traffic pattern.

While subjected to the original traffic pattern, the modified weather pattern deteriorates the stiffness of both Sections 3 and 8 more quickly than the original weather pattern, as can be seen in Figures 7.22 and 7.24. Also note that there is almost no wander effect for both mixes.

7.5 Traffic and Weather Effects

From the simulation of the ELSYM5 results, it was found that the relationship among temperature, stiffness, and fatigue life is usually as follows:

1. In general, for a mix, the high temperatures will cause low stiffness and thus induce a high strain level at the bottom of the asphalt concrete layer.
2. Low temperatures will cause high stiffness and thus induce low strains.

However, it can also be recognized from the fatigue analysis of Chapter 4 that the same mix experiences less fatigue damage, meaning longer fatigue life, at higher temperatures; vice versa, more fatigue damage occurs at lower temperatures for a given strain. In addition, the fatigue test results show that a low strain level always accompanies a longer fatigue life. It is confusing that the fatigue test results seem to contradict the statements from the ELSYM5 analyses. To resolve this confusion, it is better to examine fatigue life from the viewpoint of temperature effect and strain effect rather than from the viewpoint of literal understanding. In other words, for any mix, its fatigue life is determined by temperature and strain. Both effects and, if possible, the interaction of the two need to be estimated quantitatively to determine which effect is dominant. Thus, it is important to take into account both traffic and weather effects in running a simulation or designing a pavement. It should be noted that the traffic pattern is strain-related and the weather pattern is temperature-related.

To further verify the main and/or interaction effects made by the traffic and weather on fatigue performance, several simulations were conducted. Sections 3 and 8 were chosen as representative sections. The applied correction factor remained one. The modified traffic pattern was the same file defined in Chapter 7.3. The modified weather file is the same file utilized in Chapter 7.4.

Weather effect: sec.3, AV=12.4, AC=4.97 (wander)

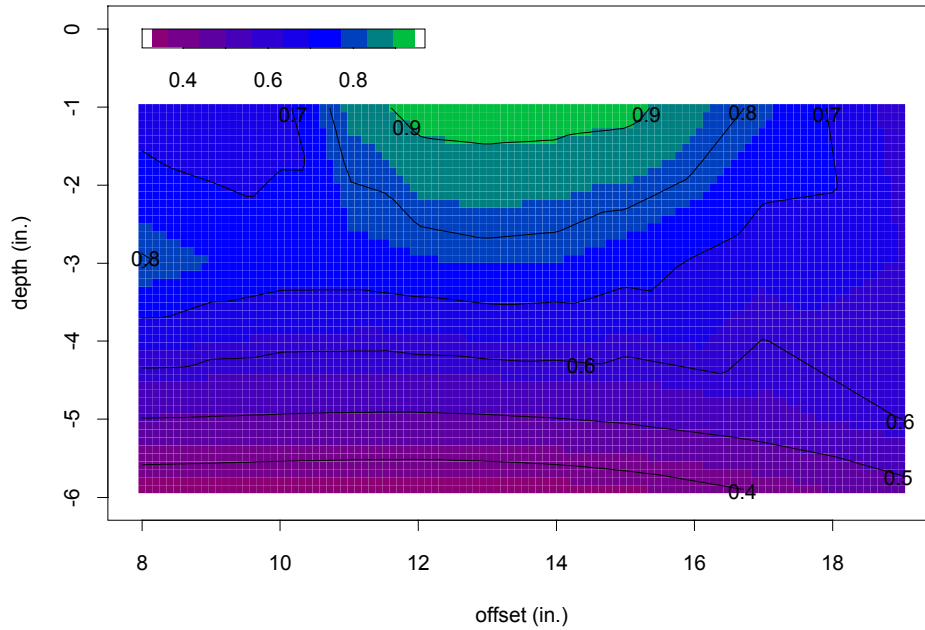

(a)

Weather effect: sec.3, AV=12.4, AC=4.97 (no wander)

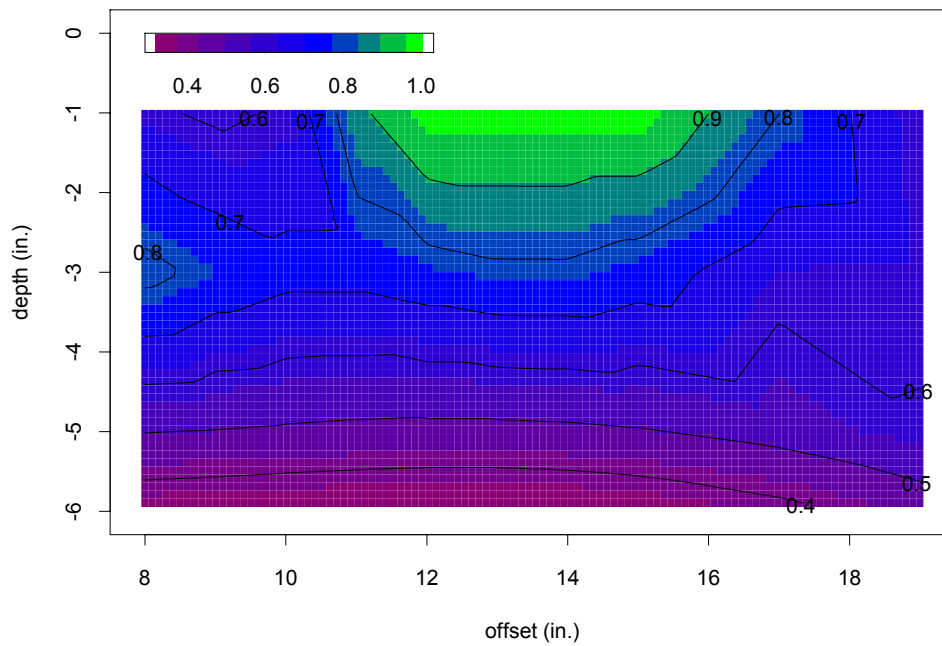

(b)

Figure 7.21. Image-and-contour plots of SR of WesTrack Section 3 with modified weather pattern: (a) wander and (b) no wander.

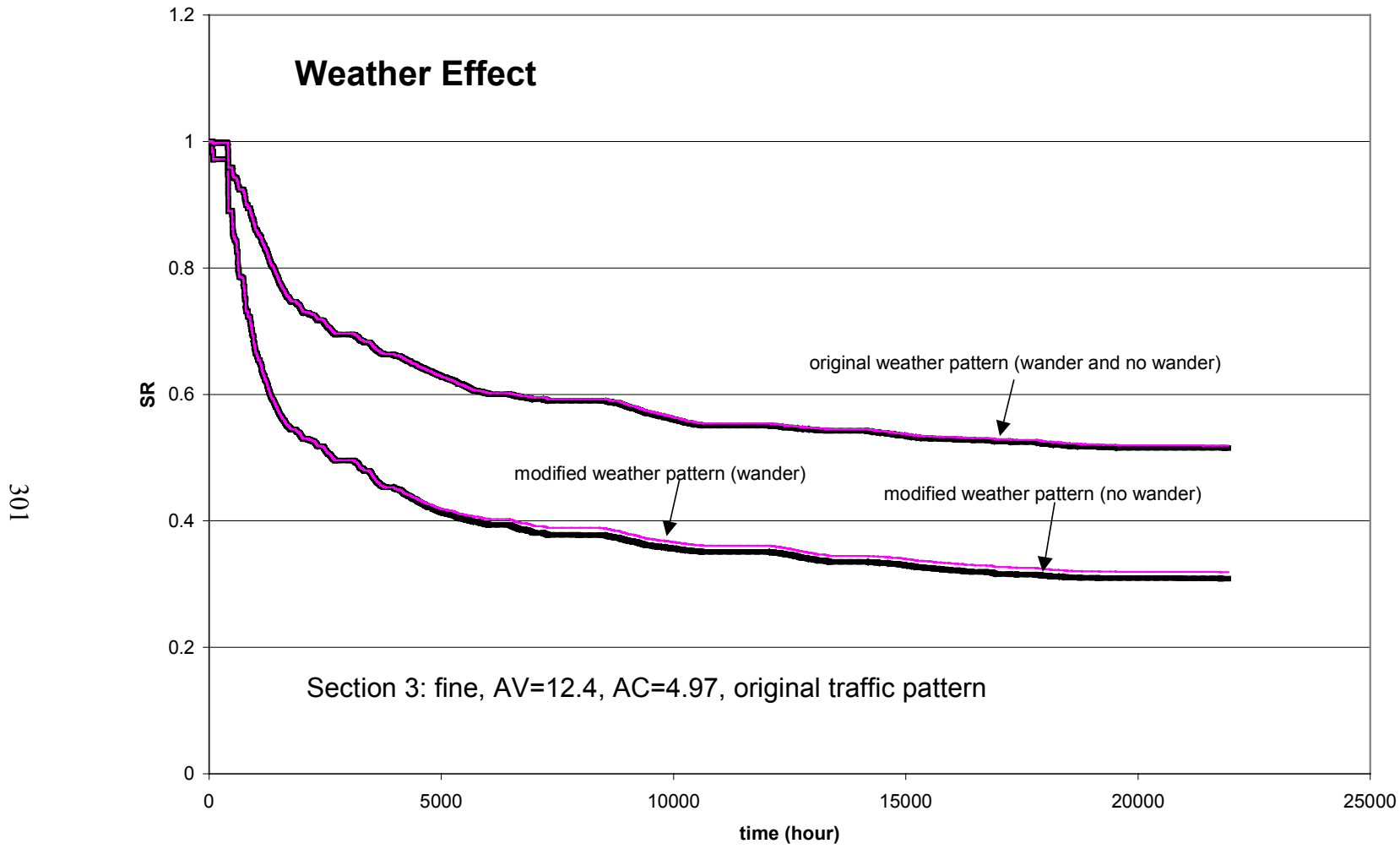
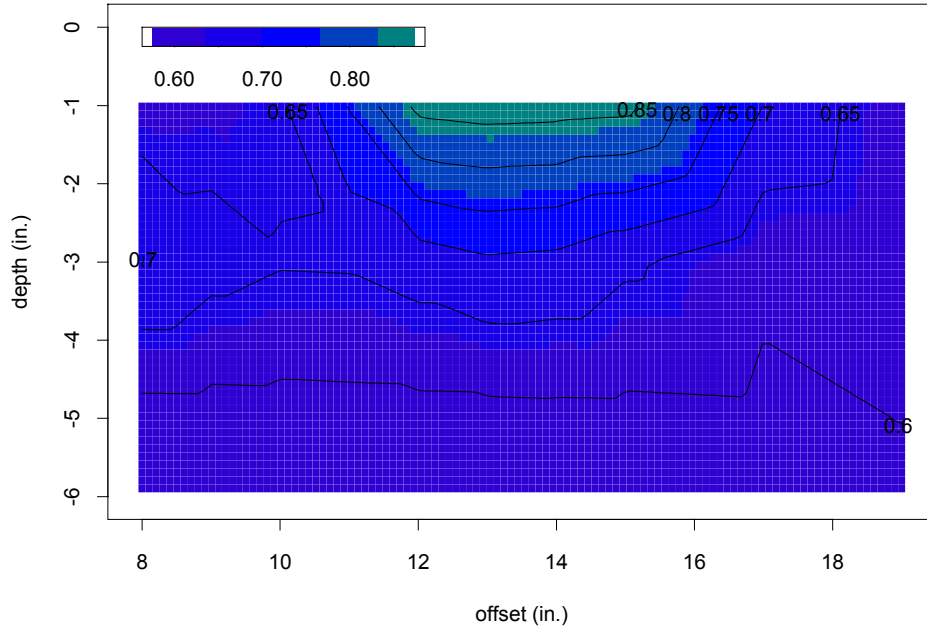

Figure 7.22. Stiffness deterioration curves of WesTrack Section 3 with modified weather pattern.

Weather effect: sec.8, AV=8.5, AC=5.47 (wander)



(a)

Weather effect: sec.8, AV=8.5, AC=5.47 (no wander)

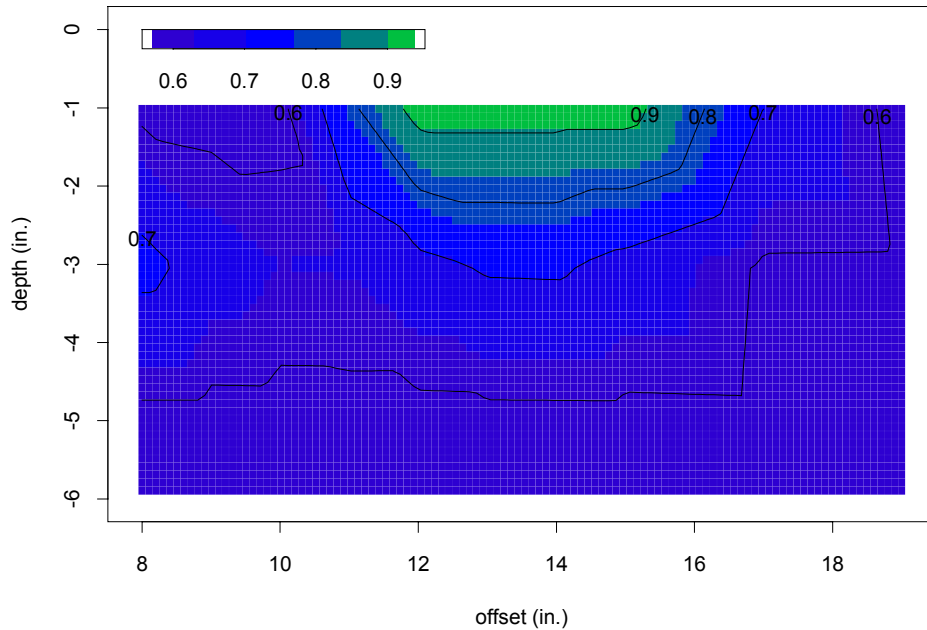

(b)

Figure 7.23. Image-and-contour plots of SR of WesTrack Section 8 with modified weather pattern: (a) wander and (b) no wander.

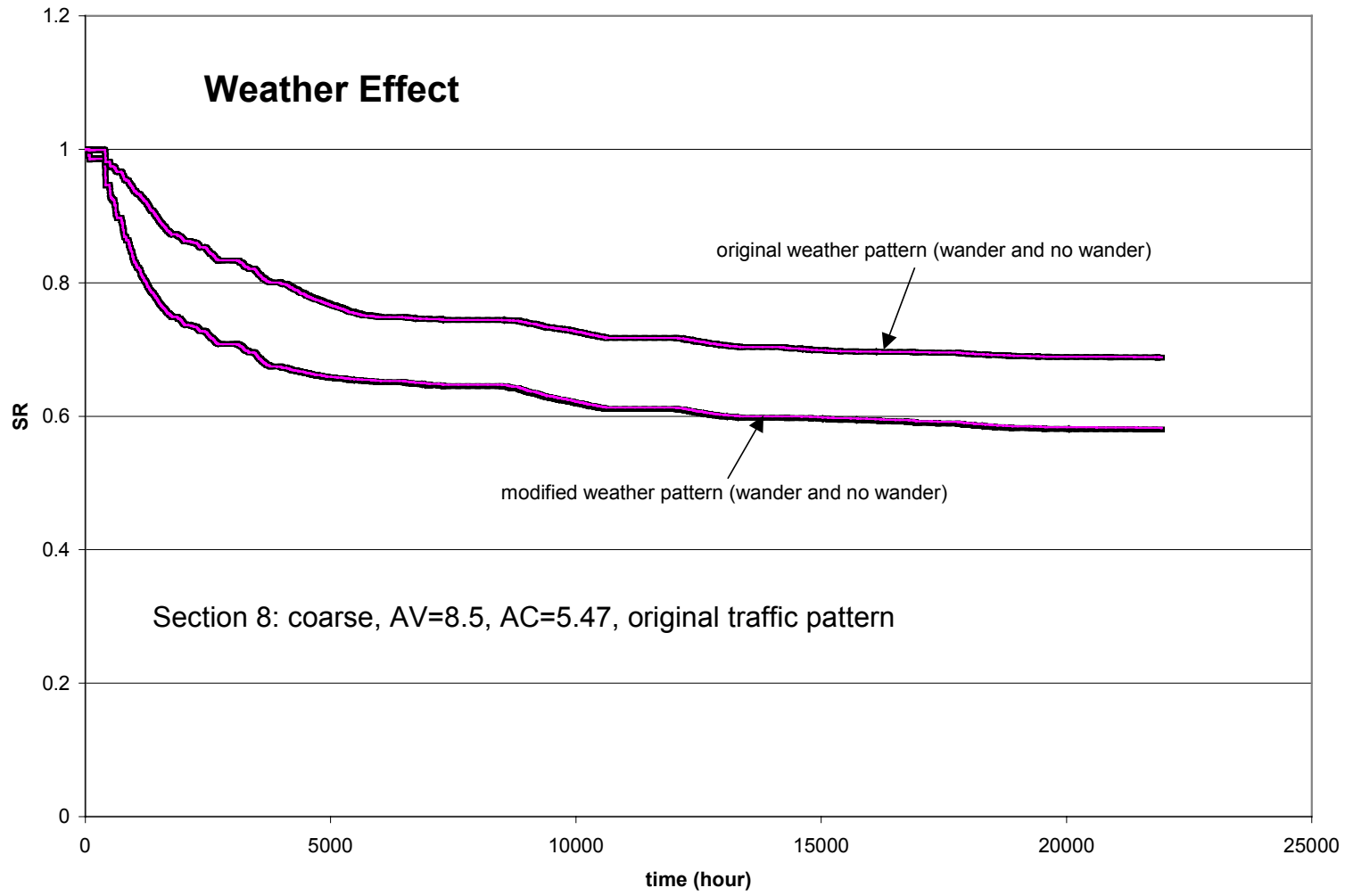

Figure 7.24. Stiffness deterioration curves of WesTrack Section 8 with modified weather pattern.

In Figure 7.25a, the final pavement deterioration pattern for Section 3 is similar to the pattern with modified traffic only, as shown in Figure 7.17a. The only deviance is that the pavement deteriorates more under the combined effect. From Figure 7.25b, no considerable difference is perceived in the final pavement deterioration pattern of the no-wander case. It is interesting to note that the final pavement deterioration pattern seems to be affected only by the type of traffic pattern and not by the weather pattern.

Figure 7.26 illustrates the stiffness deterioration curves under the effect of either traffic, weather, both, or none in the same figure. The same location, which is the weakest point of the no-wander case with the original traffic and weather patterns, was chosen for comparison for all these stiffness deterioration curves. Several findings shown in this figure can be summarized:

1. With the modified traffic alone, the stiffness deterioration is less than that without any traffic or weather effects.
2. With the modified weather alone, the fatigue damage is greater than that without any traffic or weather effects.
3. When both the modified traffic and weather patterns are applied, the fatigue damage is the greatest among all the simulation cases.
4. The wander effect is prominent only in those simulations with the modified traffic pattern. Those cases with the weather effect alone do not show any wander effect.
5. Under the application of original weather pattern, the modified traffic pattern reduces the fatigue damage, whereas the modified traffic pattern accelerates the fatigue damage when subjected to the modified weather pattern. This indicates that the traffic and weather patterns must be considered simultaneously when a pavement is designed.

Weather and traffic effects: sec.3, AV=12.4, AC=4.97 (wander)

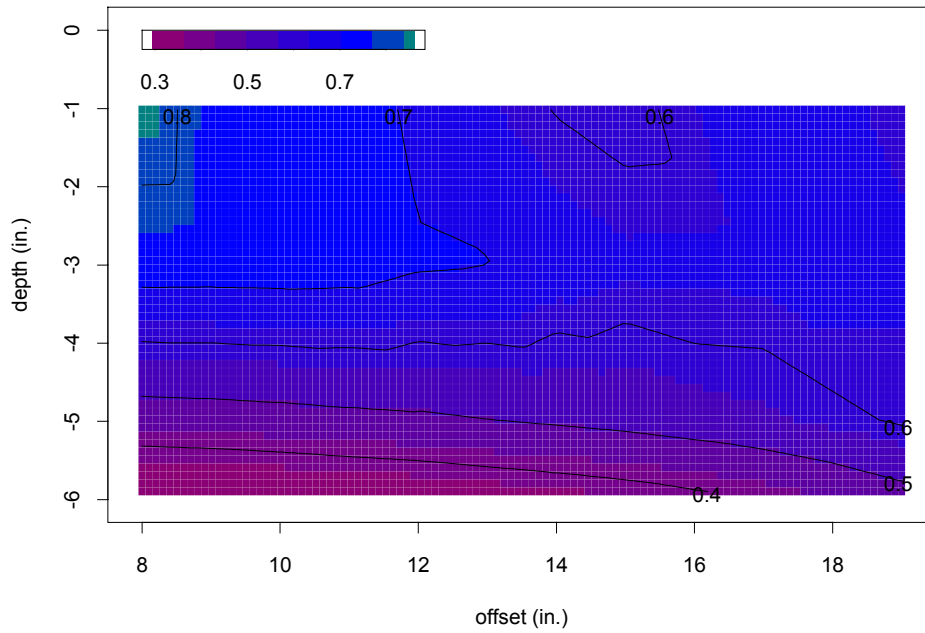

(a)

Weather and traffic effects: sec.3, AV=12.4, AC=4.97 (no wander)

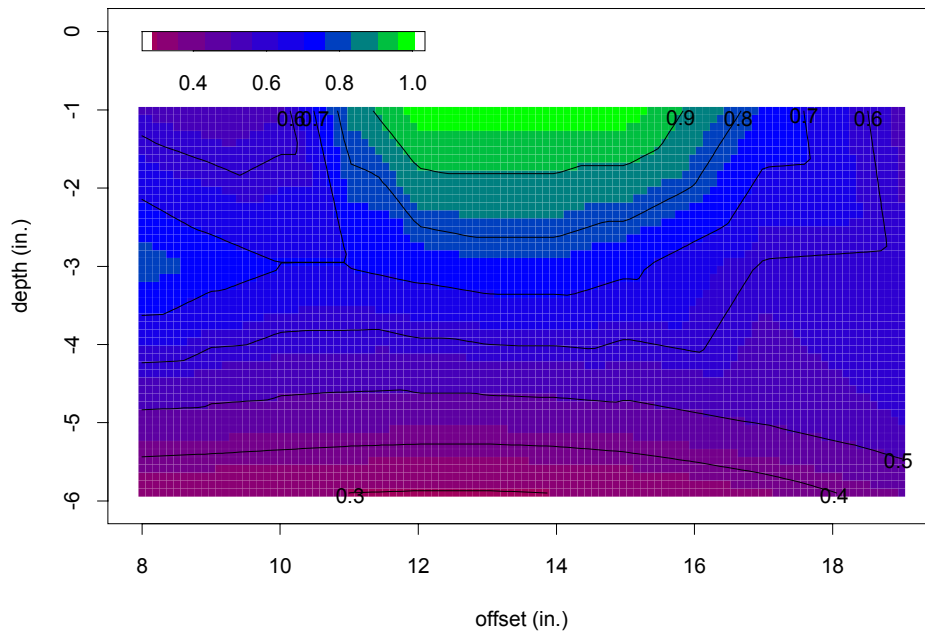

(b)

Figure 7.25. Image-and-contour plots of SR of WesTrack Section 3 with modified weather and traffic patterns: (a) wander and (b) no wander.

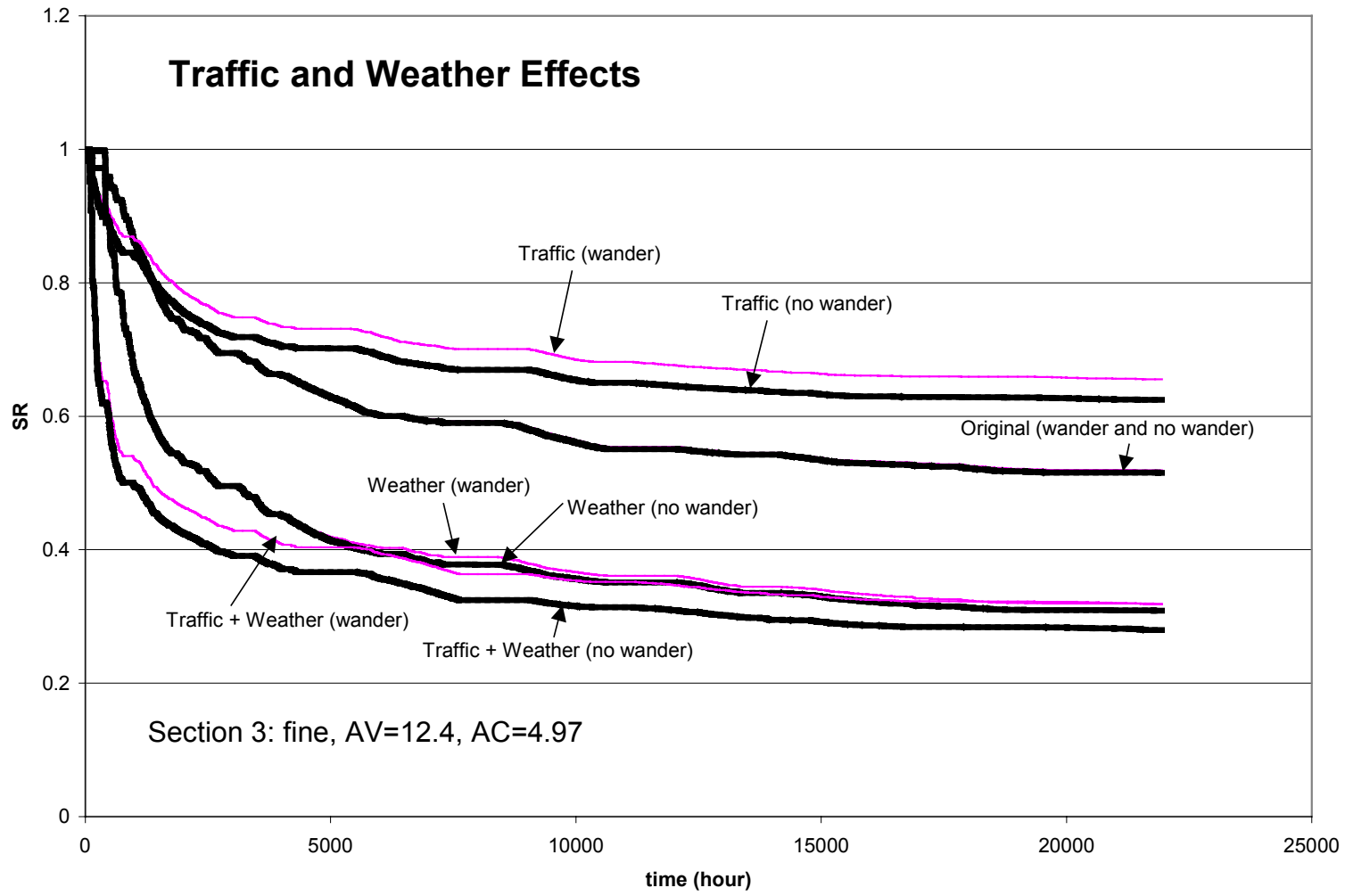

Figure 7.26. Stiffness deterioration curves of WesTrack Section 3 with various weather and traffic patterns.

As for Section 8, Figure 7.27 plots the pavement deterioration of the wander and no-wander cases and Figure 7.28 presents the stiffness deterioration curves with traffic and weather effects. The same conclusions from Section 3 apply to Section 8. One obvious discrepancy is that no wander effect is perceived, no matter which type of traffic or weather pattern is applied. Again, the simulation results tell us that the wander effect is mix-dependent.

7.6 Construction Variability and Simulation

Construction variability can be attributed to variations in the degree of compaction, reflecting differences in the air-void content, the thickness of the asphalt concrete layer, and the asphalt content. In the following sections, these construction variations are discussed with the Weibull simulation results. The simulations were applied to the Sections 3 and 8 with a correction factor of 1.0. The modified traffic pattern and the original weather pattern were utilized in the simulations.

7.6.1 Degree of Compaction

Among the construction variables, the degree of compaction is the most susceptible to construction practices. Generally, the percent air-void content may be reduced to some degree by traffic, resulting in a more capable fatigue-resistant mix. This is so called “traffic compaction”. Shin (1999) inspected the air-void contents of WesTrack field cores and found out that the air-void contents were considerably reduced after 9 months of traffic loading (as listed in Table 7.4). As can be seen in the table, the fine-plus gradation had the most percentage reduction among the gradations and in general the bottom lift had less reduction of air-void content than the top.

Weather and traffic effects: sec.8, AV=8.5, AC=5.47 (wander)

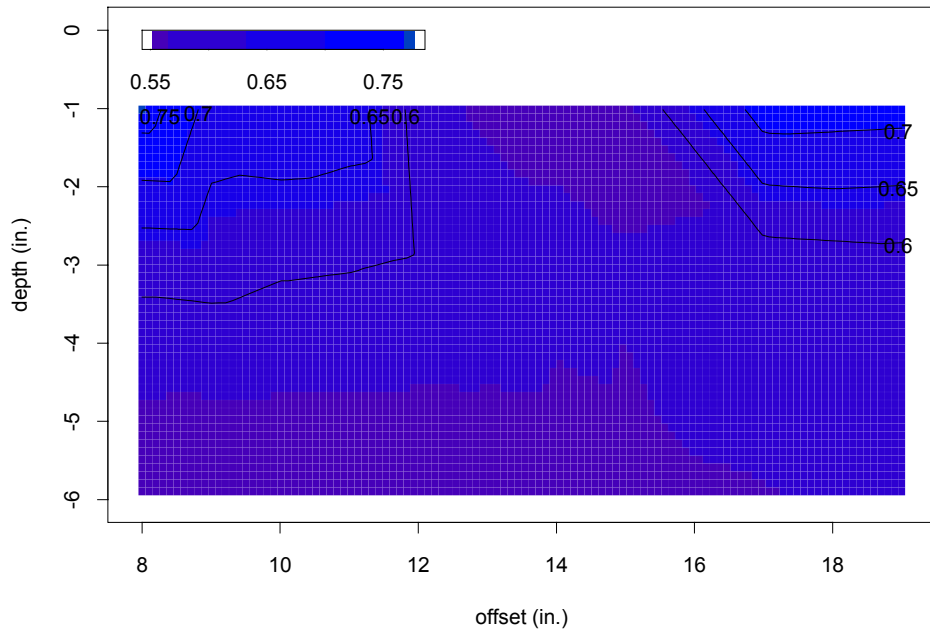

(a)

Weather and traffic effects: sec.8, AV=8.5, AC=5.47 (no wander)

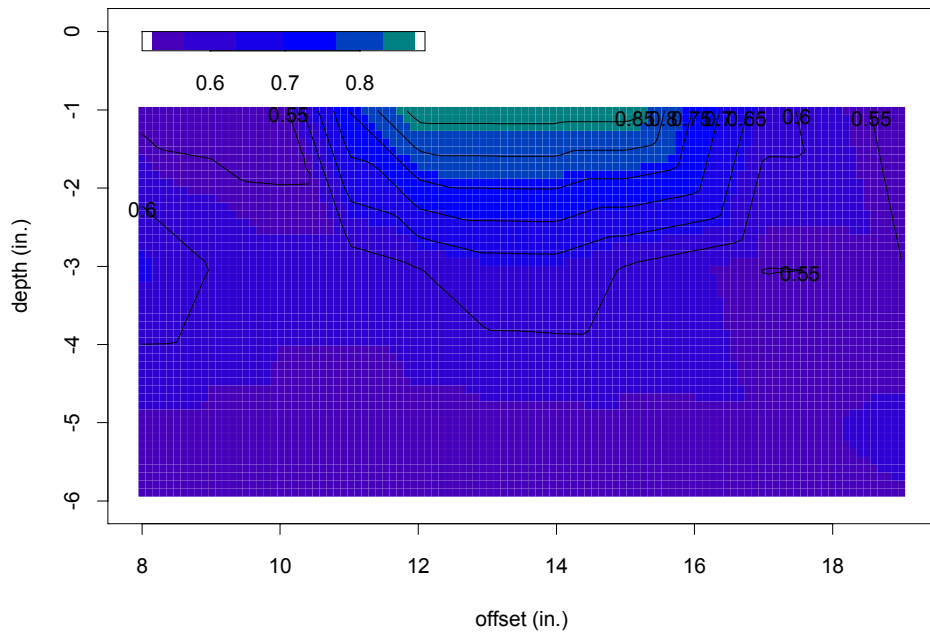

(b)

Figure 7.27. Image-and-contour plots of SR of WesTrack Section 8 with modified weather and traffic patterns: (a) wander and (b) no wander.

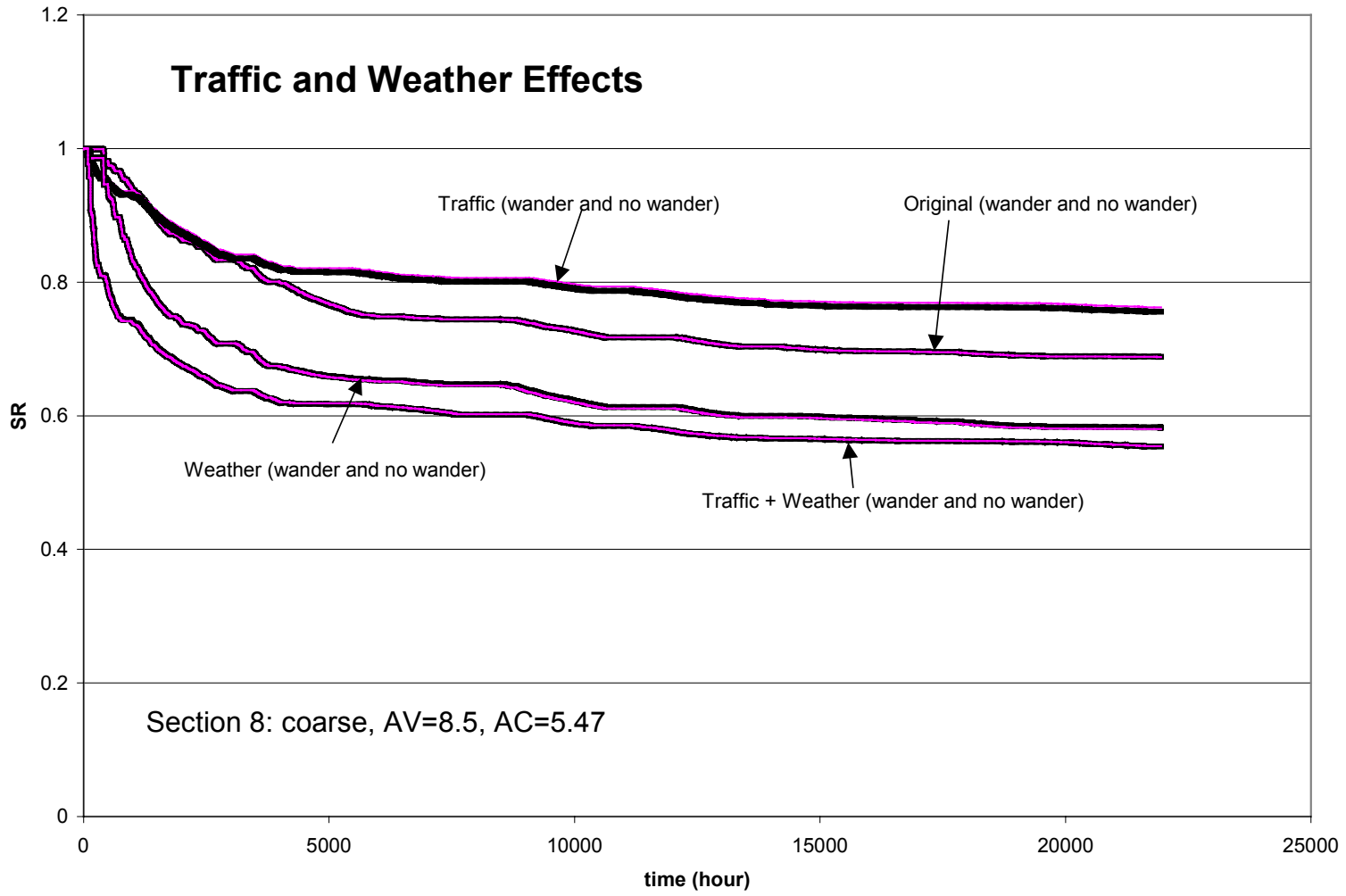

Figure 7.28. Stiffness deterioration curves of WesTrack Section 8 with various weather and traffic patterns.

Table 7.4 Percentage Reduction of Air-Void Contents of WesTrack after 9 Months of Traffic Loading

	Coarse		Fine		Fine-plus	
	Mean	Std. Dev.	Mean	Std. Dev.	Mean	Std. Dev.
AV TOP (75mm)	39.5	20.1	35.7	13.1	48.7	16.7
AV BOTTOM (75mm)	29.2	10.7	32.0	14.4	38.6	13.5

Although this phenomenon can be simulated in this version of Weibull program, this section focuses on the simulation of the initial degree of compaction. The WesTrack Sections 3 (fine, AV = 12.4, AC = 4.97) and 8 (coarse, AV = 8.5, AC = 5.47) will be used as the demonstration examples of the AV effect. Two air-void contents, 10.4 and 14.4 percent, will be applied to Section 3, i.e., ± 2 percent difference from the original air-void content. Two air-void contents, 6.5 and 10.5 percent, will be applied to Section 8.

The pavement deterioration results of various air-void contents are shown in Figure 7.29 and Figure 7.30 for 10.4 and 14.4 percent, respectively. In general, the pavement with high air-void content displays more fatigue damage than that with low air-void content.

Figure 7.31 displays the stiffness deterioration curves with various air-void contents for Section 3. With a difference of only 2 percent air-void content, the stiffness deterioration could be very different. In general, higher air-void contents lead to more fatigue damage.

The pavement deterioration patterns of Section 8 at air-void contents of 6.5 and 10.5 percent are displayed in Figure 7.32 and Figure 7.33, respectively. It is obvious that fatigue damage at 10.5 percent air-void content is considerably greater than at 6.5 percent air-void content.

The stiffness deterioration curves with various air-void contents are drawn and summarized in Figure 7.34. Notice that no wander effect is presented for various air-void

AV effect: sec.3,AV=10.4,AC=4.97 (wander)

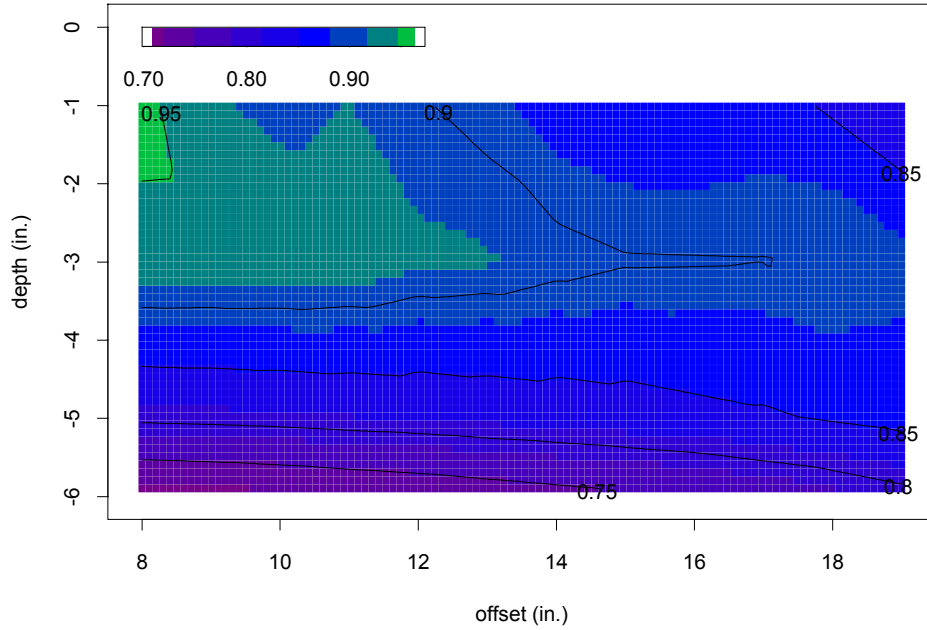

(a)

AV effect: sec.3,AV=10.4,AC=4.97 (no wander)

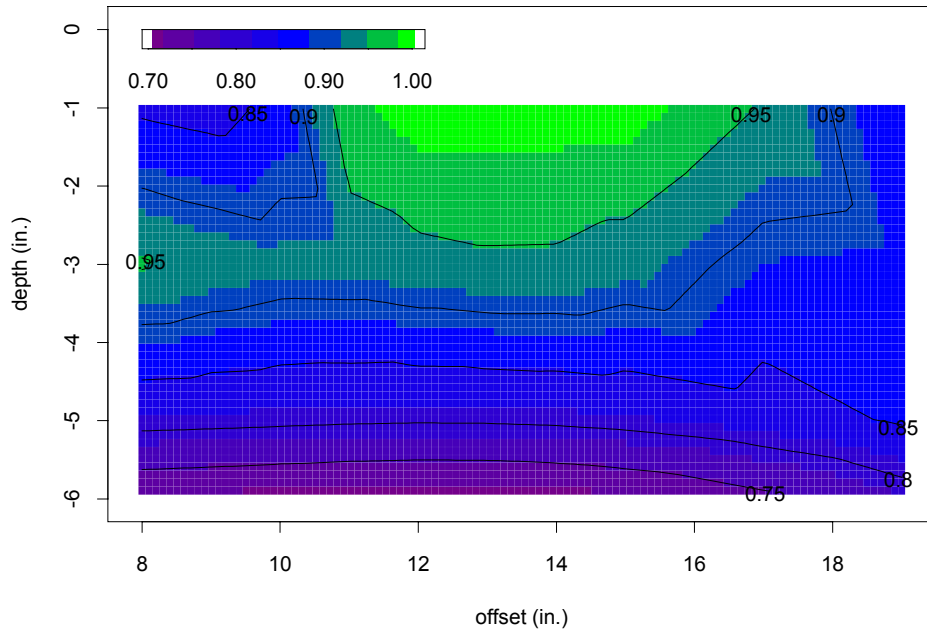

(b)

Figure 7.29. Image-and-contour plots of SR of WesTrack Section 3 with 2 % less air-void content (10.4 %): (a) wander and (b) no wander.

AV effect: sec.3,AV=14.4,AC=4.97 (wander)

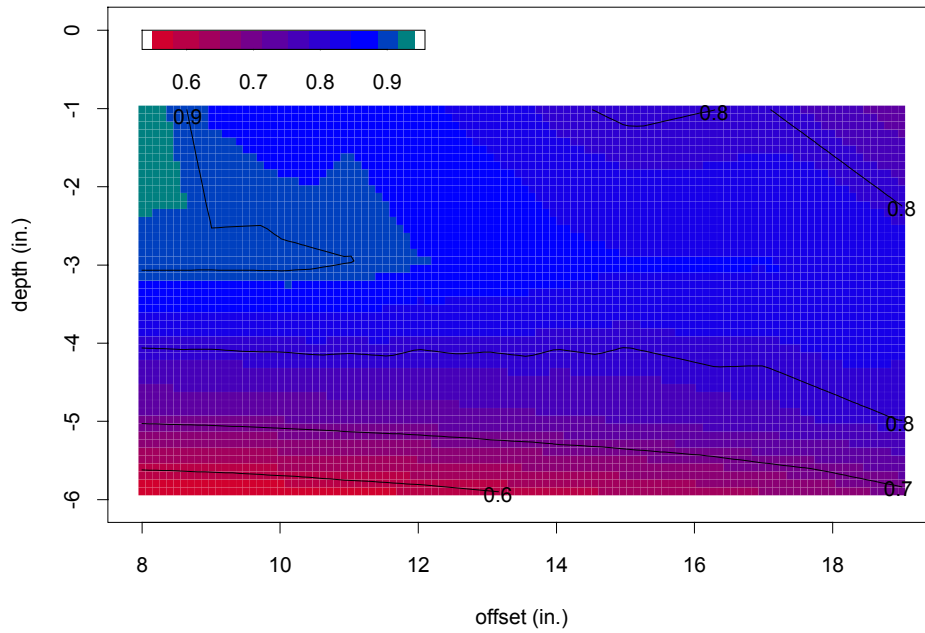

(a)

AV effect: sec.3,AV=14.4,AC=4.97 (no wander)

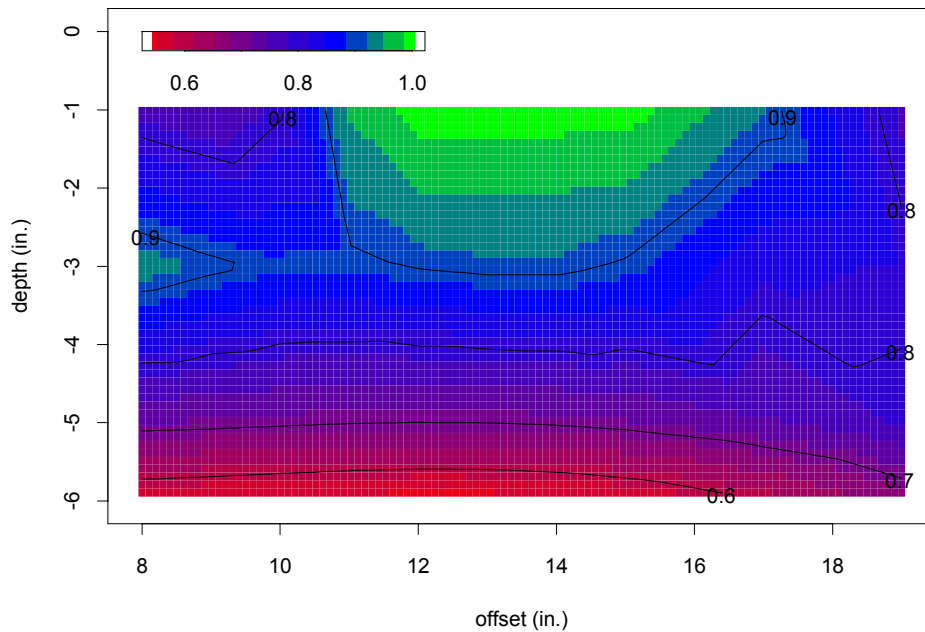

(b)

Figure 7.30. Image-and-contour plots of SR of WesTrack Section 3 with 2 % more air-void content (14.4 %): (a) wander and (b) no wander.

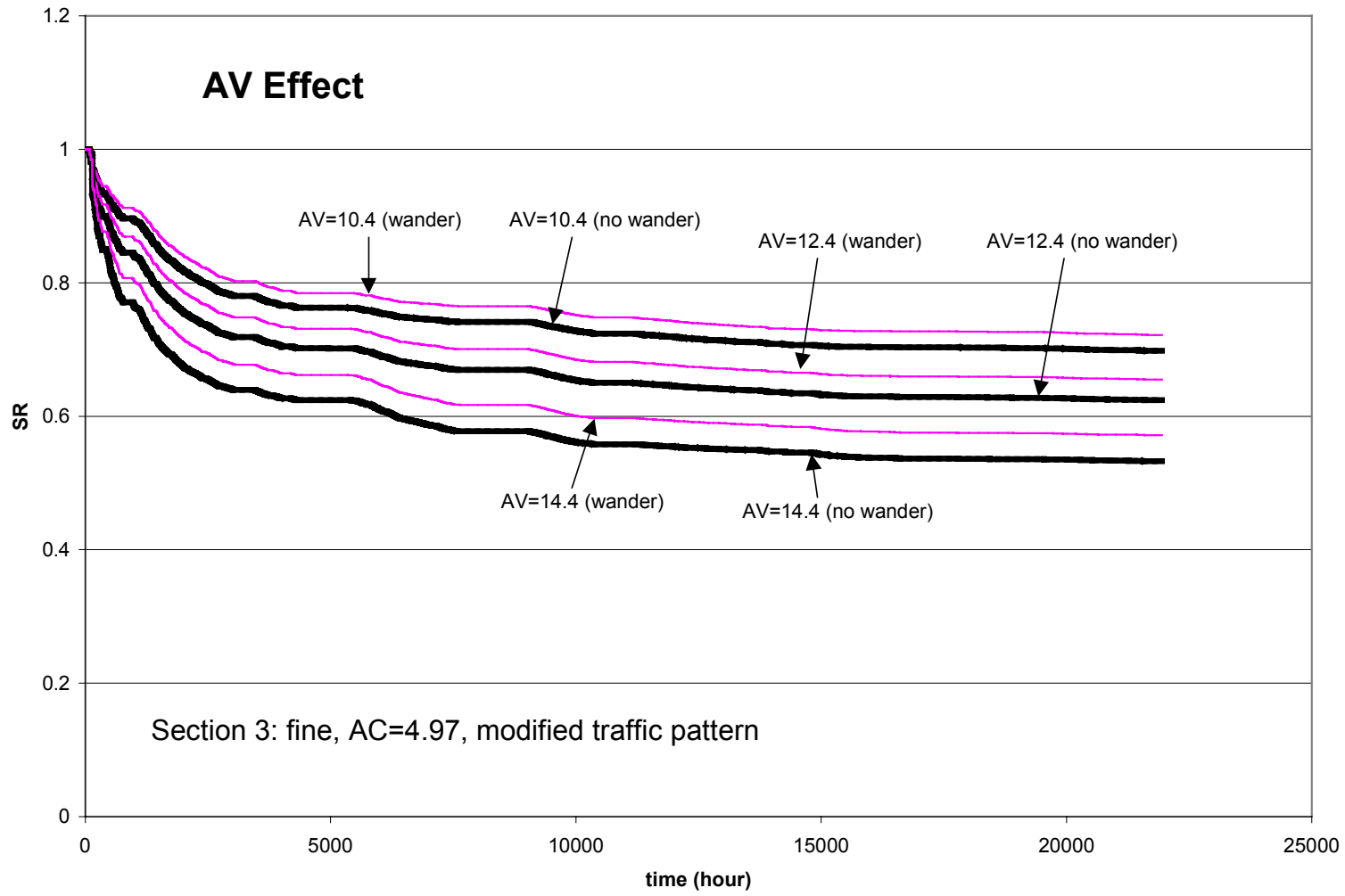
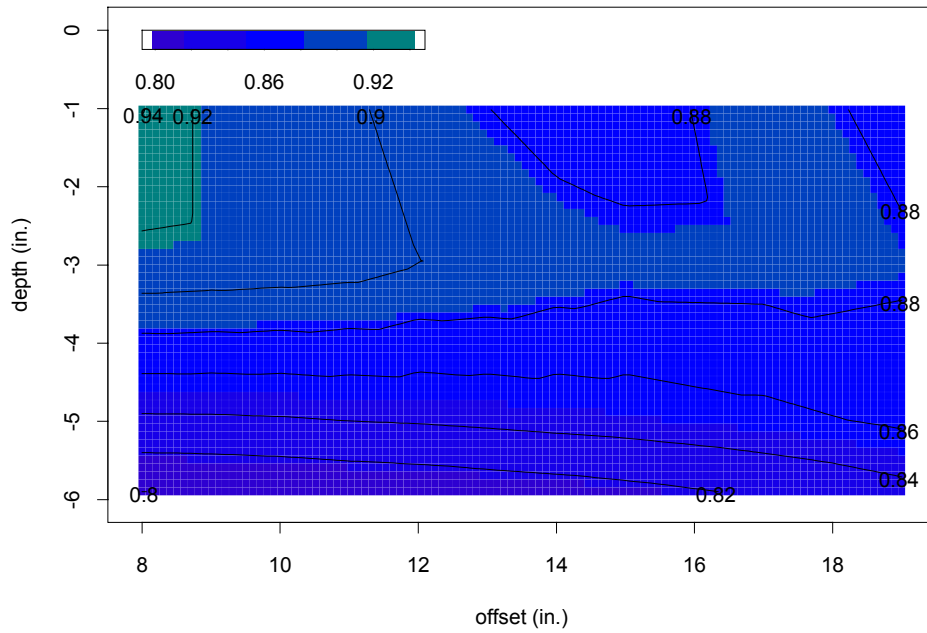

Figure 7.31. Stiffness deterioration curves of WesTrack Section 3 with various air-void contents.

AV effect: sec.8,AV=6.5,AC=5.47 (wander)



(a)

AV effect: sec.8,AV=6.5,AC=5.47 (no wander)

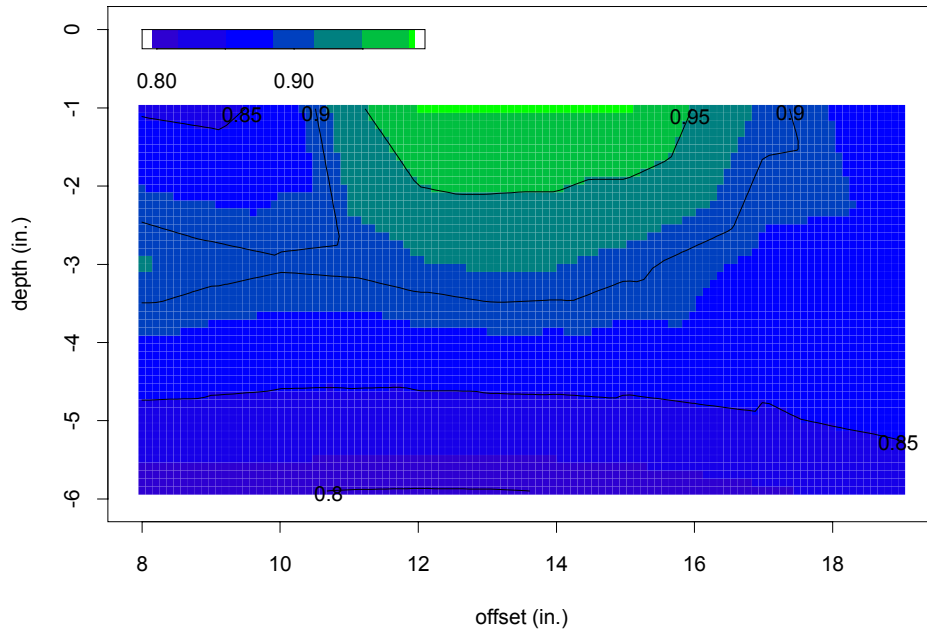

(b)

Figure 7.32. Image-and-contour plots of SR of WesTrack Section 8 with 2 % less air-void content (6.5 %): (a) wander and (b) no wander.

AV effect: sec.8,AV=10.5,AC=5.47 (wander)

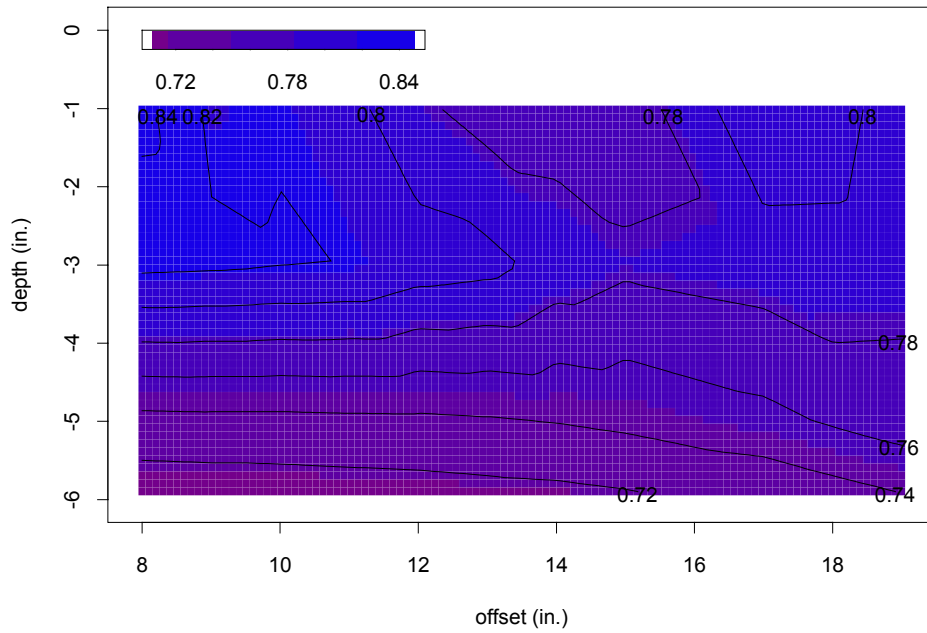

(a)

AV effect: sec.8,AV=10.5,AC=5.47 (no wander)

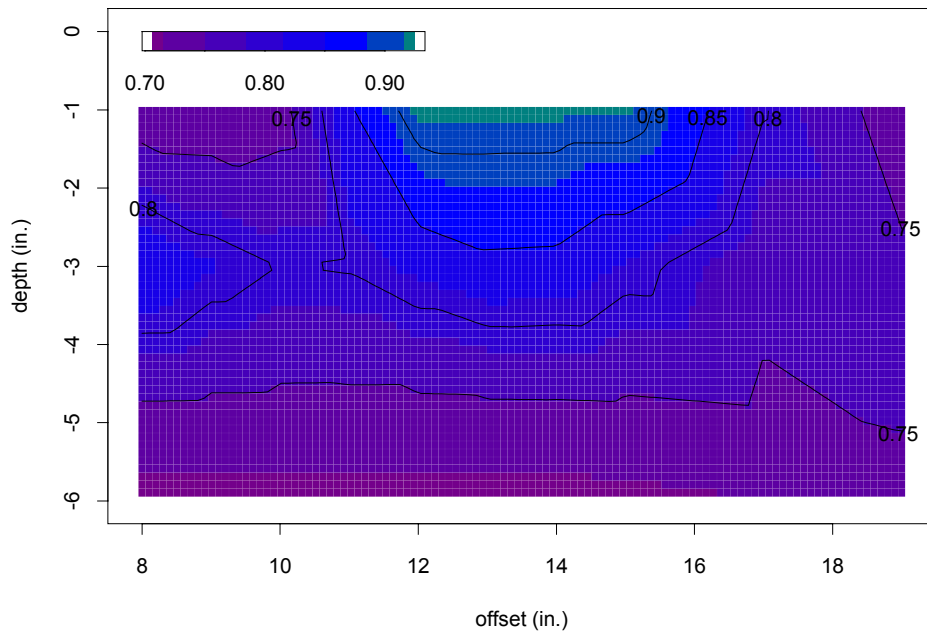

(b)

Figure 7.33. Image-and-contour plots of SR of WesTrack Section 8 with 2 % more air-void content (10.5 %): (a) wander and (b) no wander.

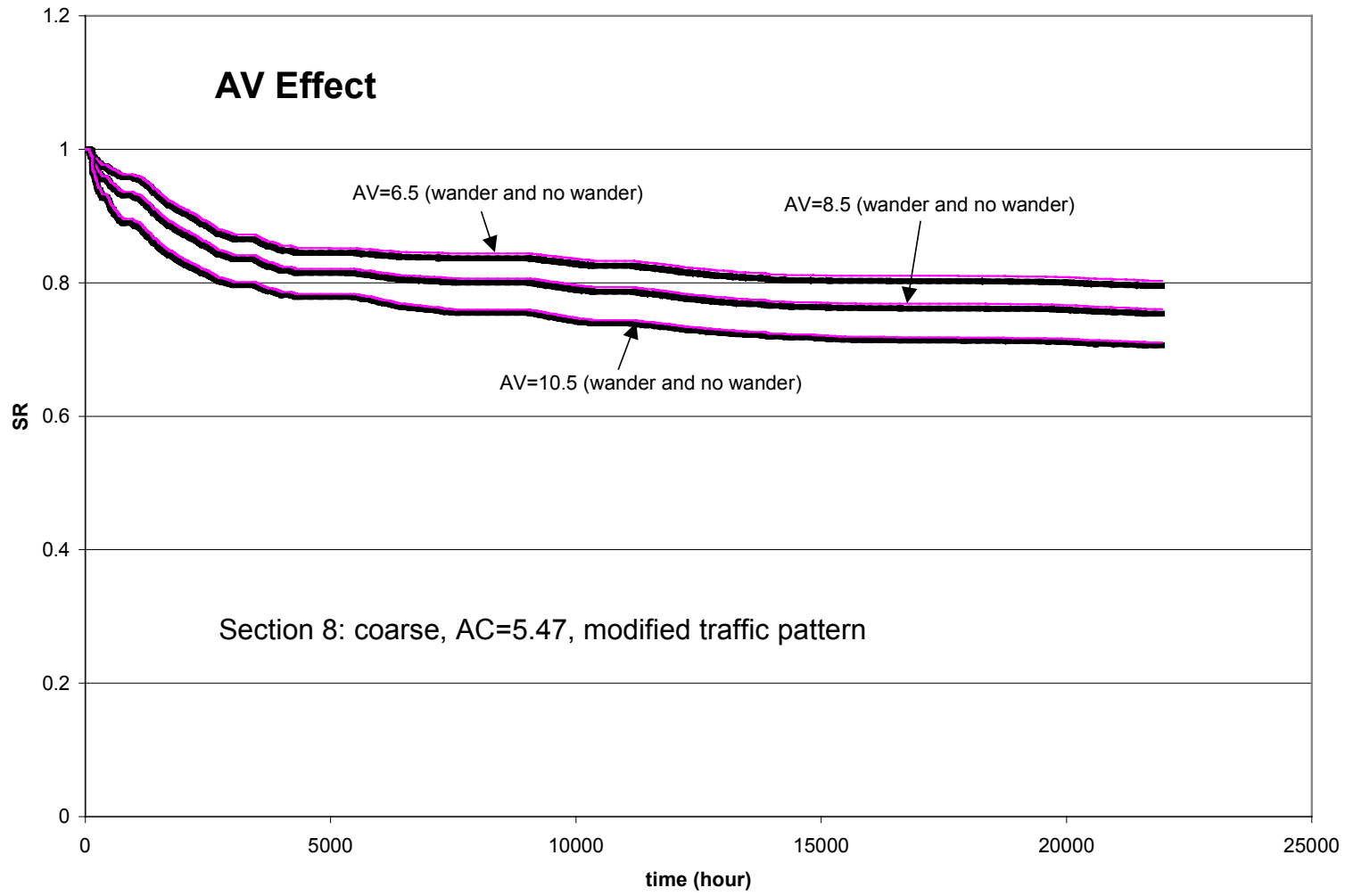

Figure 7.34. Stiffness deterioration curves of WesTrack Section 8 with various air-void contents.

contents, although the same modified traffic pattern has caused the wander effect for Section 3. The degree of stiffness deterioration seems to be proportional to the value of air-void contents. The higher the air-void content, the greater the stiffness deterioration. Accordingly, it is recognized that quality control of compaction in constructing the pavement is very important, as many previous researchers have pointed out. It should be noted that in this simulation case the traffic compaction is not considered.

7.6.2 Thickness of the Asphalt Concrete Layer

The designed thickness of asphalt concrete layer of WesTrack is 6 inches. It is assumed that the thickness is ± 1 inch from the designed value due to the construction variation. Herein, the temperature at the bottom of the asphalt concrete layer and its corresponding temperature gradient remain unchanged regardless of the thickness. The depths of the ELSYM5 input are then 1.0, 3.0, 4.5, and 4.99 inches for a 5-inch layer; 1.0, 3.0, 5.5, and 6.99 inches for a 7-inch layer. The 5-inch layer contains three sublayers with the thickness, 2.0, 2.0, and 1.0 inches from surface below. The 7-inch layer has three sublayers with thickness 2.0, 2.0, and 3.0 inches from surface below.

The image-and-contour plots of the final pavement deterioration of WesTrack Section 3 of various thicknesses with wander and no wander are presented in Figures 7.35 through 7.37. Figures 7.39 through 7.41 illustrate the corresponding image-and-contour plots of pavement deterioration of WesTrack Section 8. An interesting phenomenon extracted from these figures is that the pattern of stiffness deterioration at depth 1.0 inch for each section is similar along the horizontal direction no matter what thickness. In general, the fatigue damage at the bottom of

Thickness effect: sec.3,AV=12.4,AC=4.97,5 in. (wander)

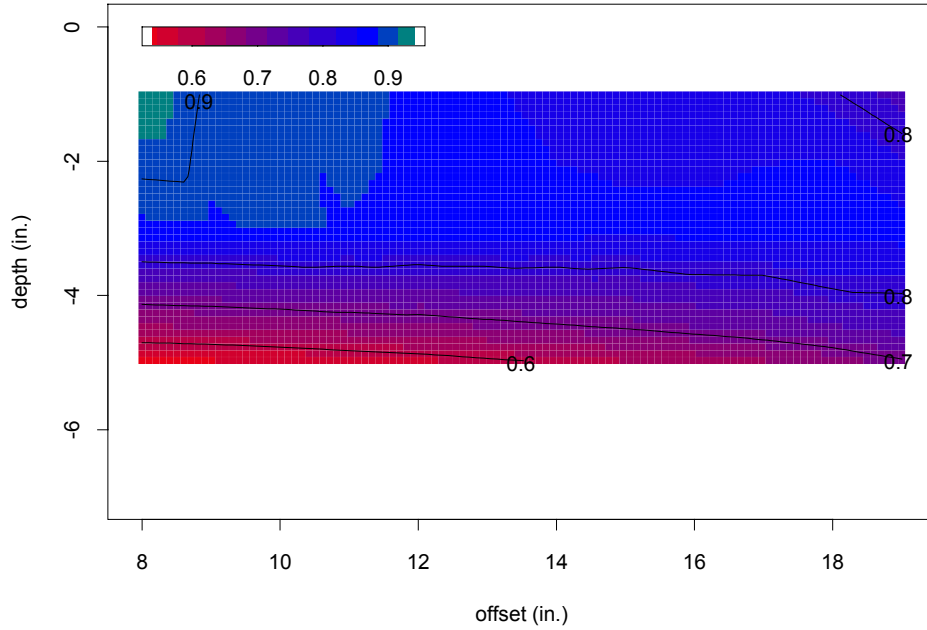

(a)

Thickness effect: sec.3,AV=12.4,AC=4.97,5 in. (no wander)

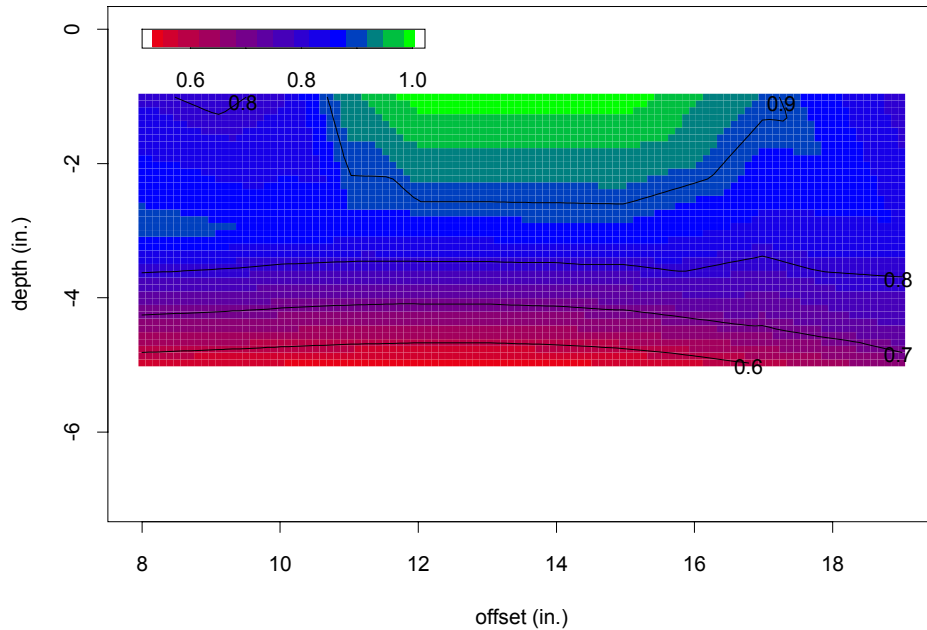

(b)

Figure 7.35. Image-and-contour plots of SR of WesTrack Section 3 with 5-inch thickness of asphalt concrete: (a) wander and (b) no wander.

Thickness effect: sec.3,AV=12.4,AC=4.97,6 in. (wander)

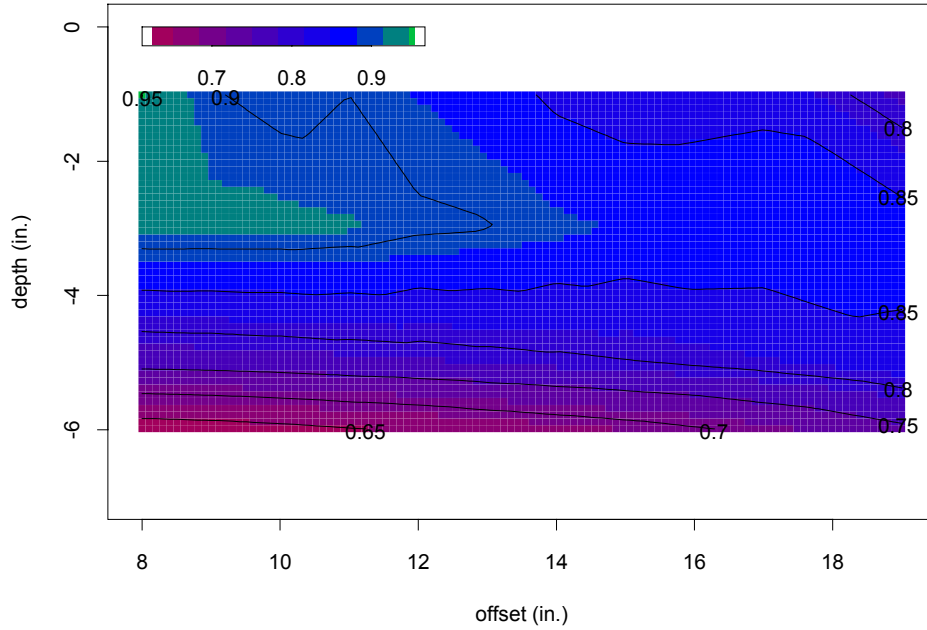

(a)

Thickness effect: sec.3,AV=12.4,AC=4.97,6 in. (no wander)

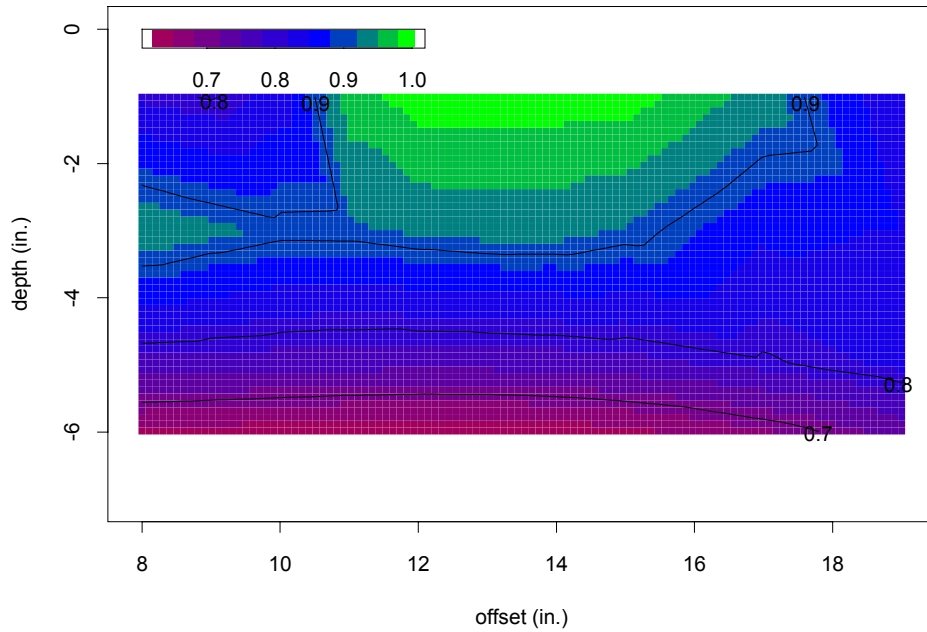

(b)

Figure 7.36. Image-and-contour plots of SR of WesTrack Section 3 with 6-inch thickness of asphalt concrete: (a) wander and (b) no wander.

Thickness effect: sec.3,AV=12.4,AC=4.97,7 in. (wander)

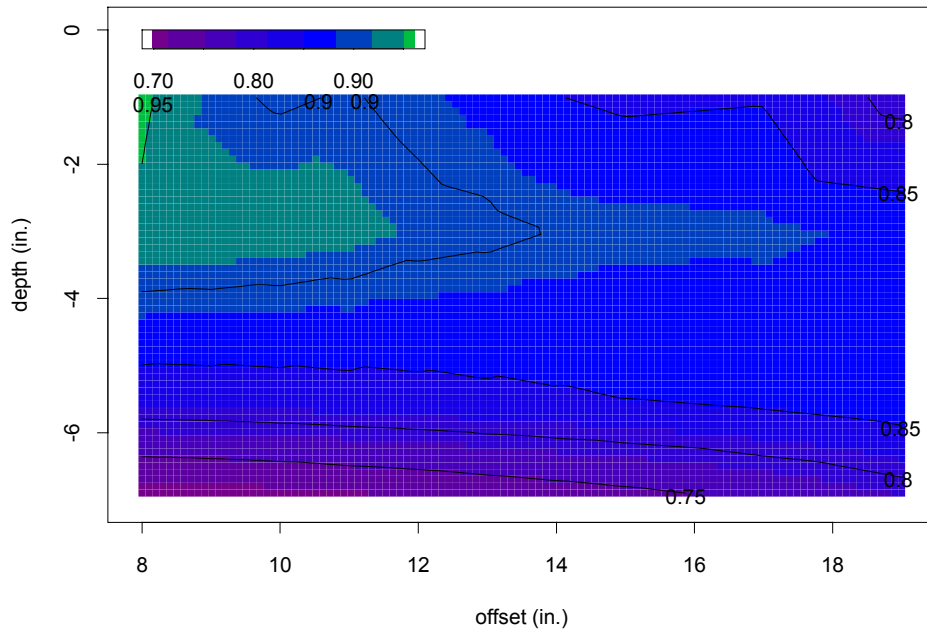

(a)

Thickness effect: sec.3,AV=12.4,AC=4.97,7 in. (no wander)

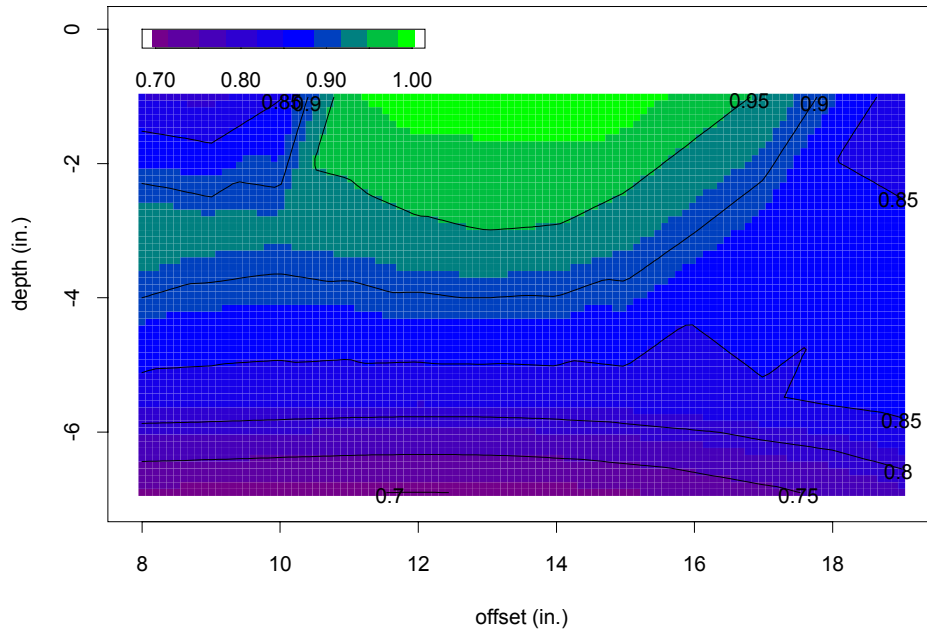

(b)

Figure 7.37. Image-and-contour plots of SR of WesTrack Section 3 with 7-inch thickness of asphalt concrete: (a) wander and (b) no wander.

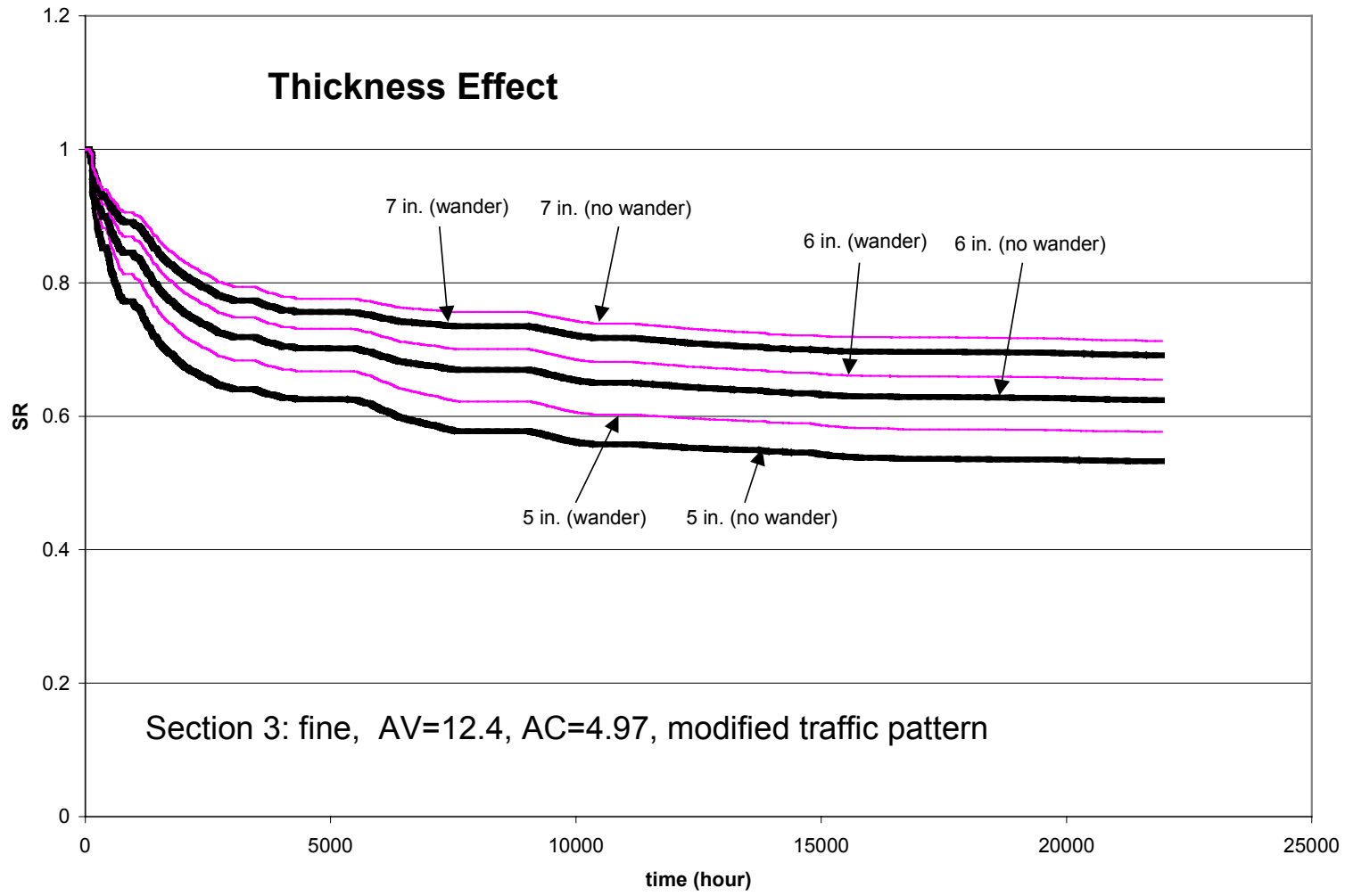
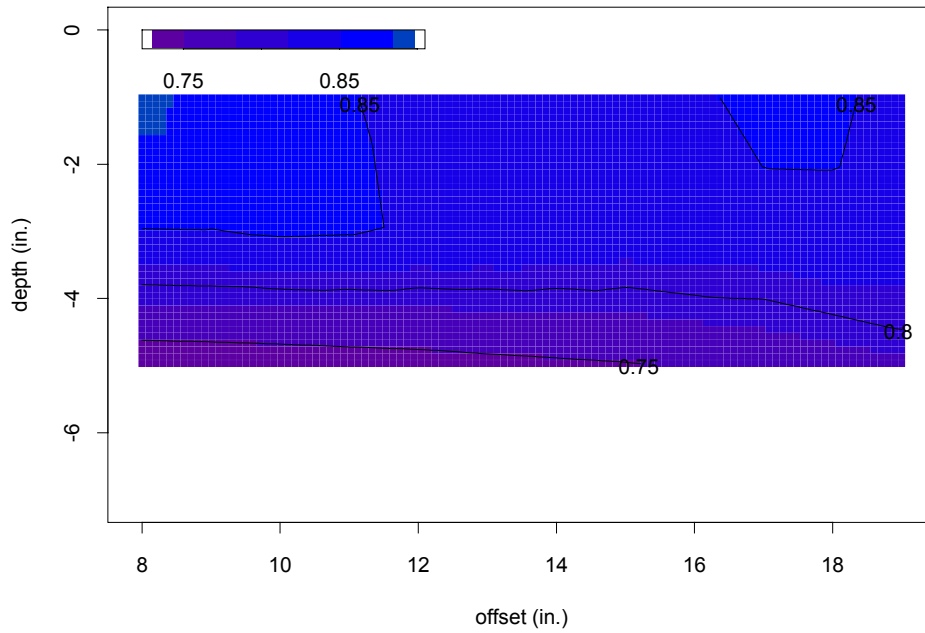

Figure 7.38. Stiffness deterioration curves of WesTrack Section 3 with various thicknesses of asphalt concrete.

Thickness effect: sec.8,AV=8.5,AC=5.47,5 in. (wander)



(a)

Thickness effect: sec.8,AV=8.5,AC=5.47,5 in. (no wander)

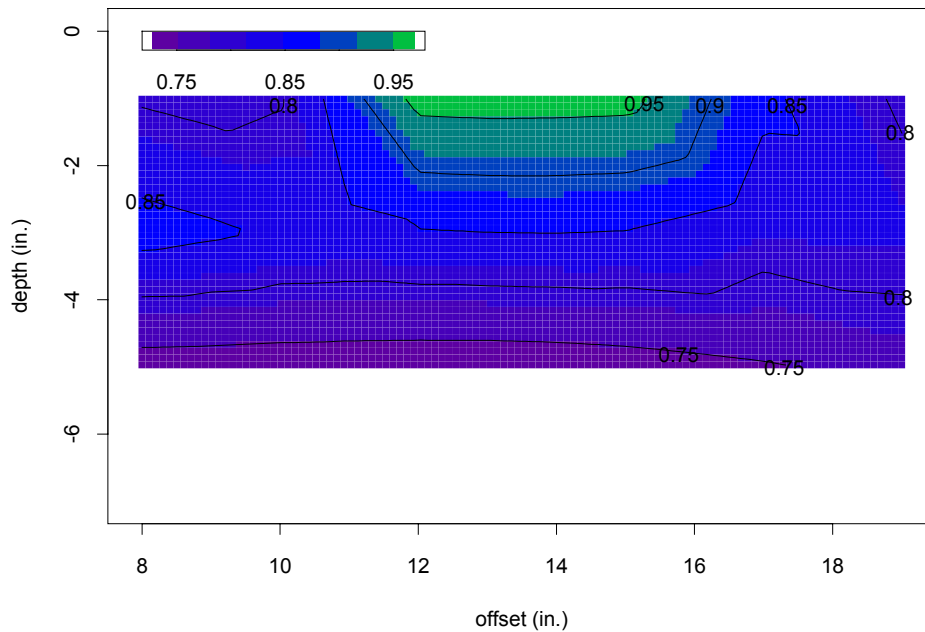

(b)

Figure 7.39. Image-and-contour plots of SR of WesTrack Section 8 with 5-inch thickness of asphalt concrete: (a) wander and (b) no wander.

Thickness effect: sec.8,AV=8.5,AC=5.47,6 in. (wander)

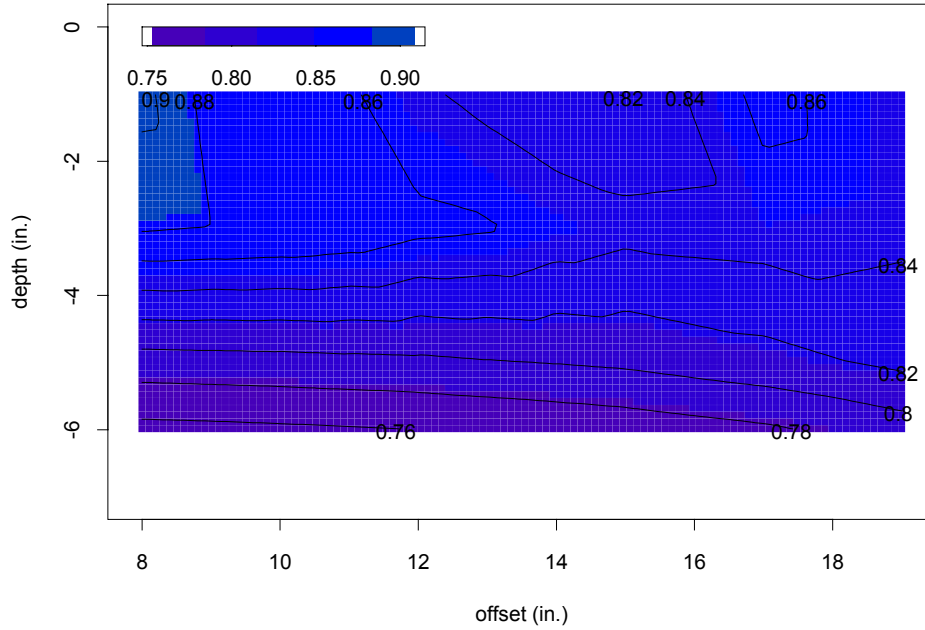

(a)

Thickness effect: sec.8,AV=8.5,AC=5.47,6 in. (no wander)

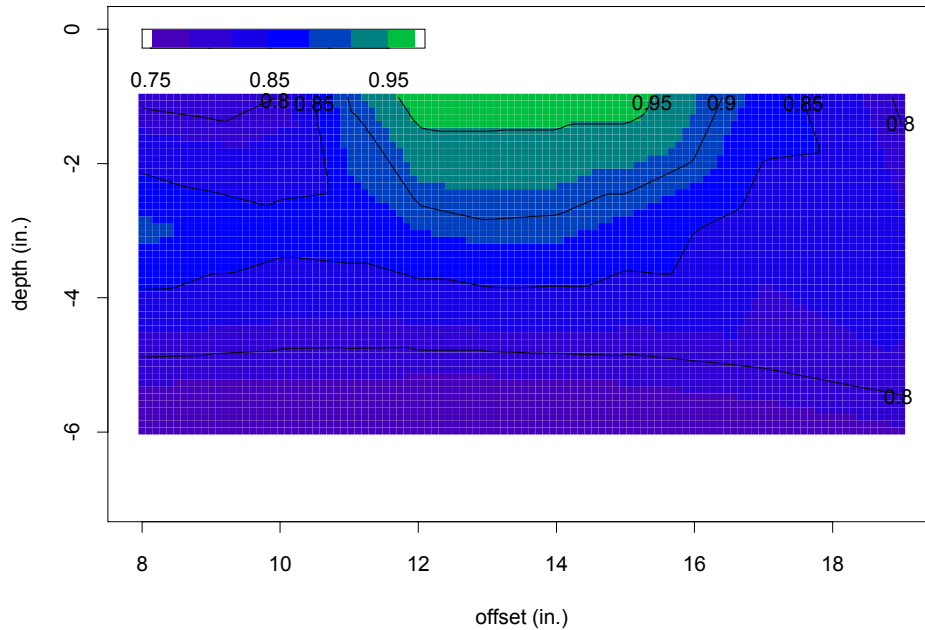

(b)

Figure 7.40. Image-and-contour plots of SR of WesTrack Section 8 with 6-inch thickness of asphalt concrete: (a) wander and (b) no wander.

Thickness effect: sec.8,AV=8.5,AC=5.47,7 in. (wander)

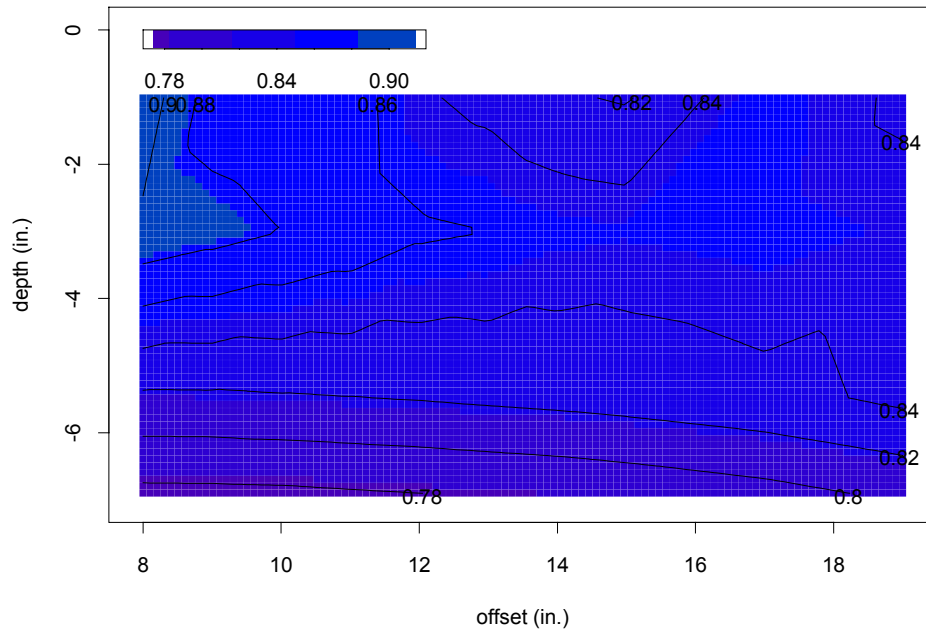

(a)

Thickness effect: sec.8,AV=8.5,AC=5.47,7 in. (no wander)

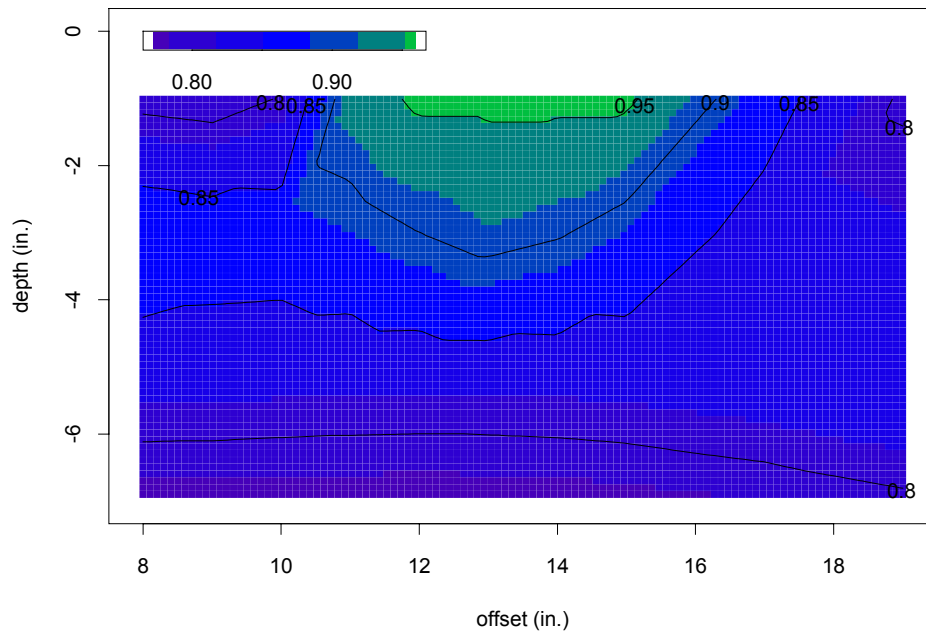

(b)

Figure 7.41. Image-and-contour plots of SR of WesTrack Section 8 with 7-inch thickness of asphalt concrete: (a) wander and (b) no wander.

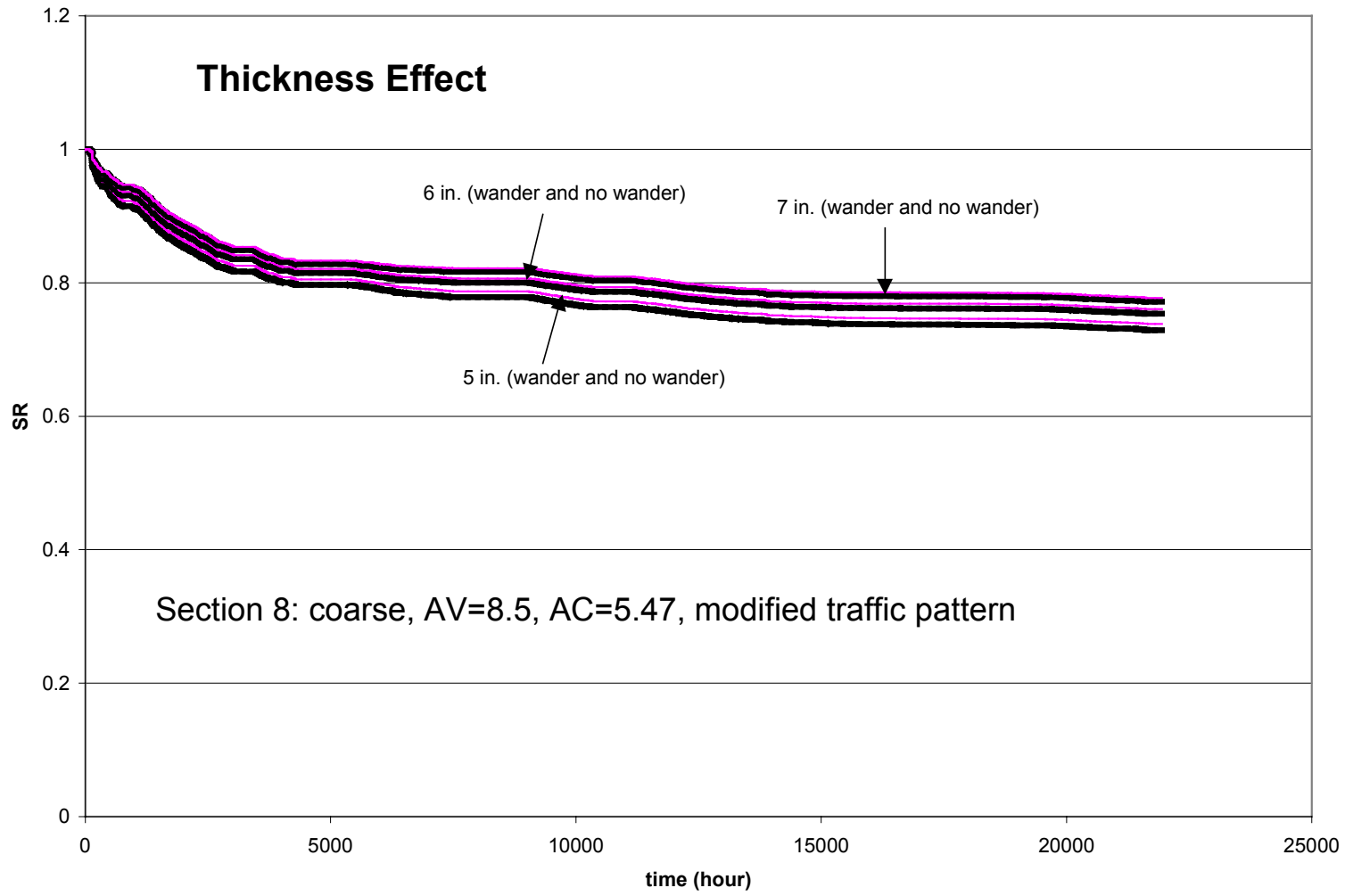

Figure 7.42. Stiffness deterioration curves of WesTrack Section 8 with various thicknesses of asphalt concrete.

the asphalt concrete layer depends on the thickness of the layer. The thinner the layer, the more the severe the fatigue damage at the bottom.

The stiffness deterioration curves at an offset of 12 inches and at the bottom of the asphalt concrete layer are plotted in Figures 7.38 and 7.42 for Sections 3 and 8, respectively. It was found that the wander effect in Section 3 not only varies with time but also changes with the thickness of the asphalt concrete layer. On the contrary, in Section 8, no wander effects are perceived regardless of thickness. In addition, the results also show that the stiffness deterioration curves of Section 8 have little fluctuation relative to the thickness variation, whereas the curves of Section 3 vary significantly relative to the thickness variation. The magnitude of variation is inversely proportional to the thickness of the asphalt concrete layer.

In sum, the findings of the thickness simulations can be listed below:

1. The thickness effect due to construction variation is mix-dependent.
2. A thinner layer displays exaggerated wander effect and deteriorates faster.
3. The coarse mix seems to have the better capacity to resist the thickness effect.

Finding 3 above may be due to the higher stiffness of the coarse mix and thus smaller strains. To further verify this point, Section 15 (fine) was selected as a comparison with Section 8 (coarse) because both sections have similar air-void contents and asphalt contents. Figures 7.43 and 7.44 display the average tensile strains at the bottom of the asphalt concrete layer with the modified traffic pattern. As seen in these figures, the strain patterns are matched to the temperature pattern, i.e., a higher temperature results in a higher tensile strain. Also, with the consideration of stiffness deterioration, during hot weather the strain increases as the damage increases. During cold weather, the strain decreases as the damage increases. Section 15 generally showed higher strains than those of Section 8. However, the difference decreases as

WesTrack Section 8

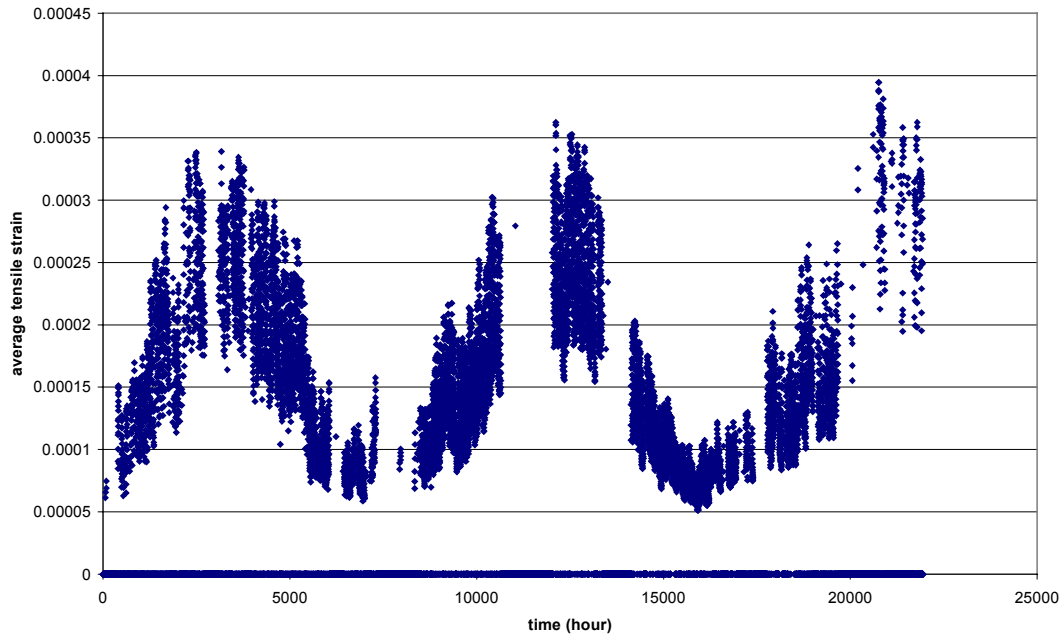

Figure 7.43. Strain history of WesTrack Section 8 with modified traffic pattern.

WesTrack Section 15

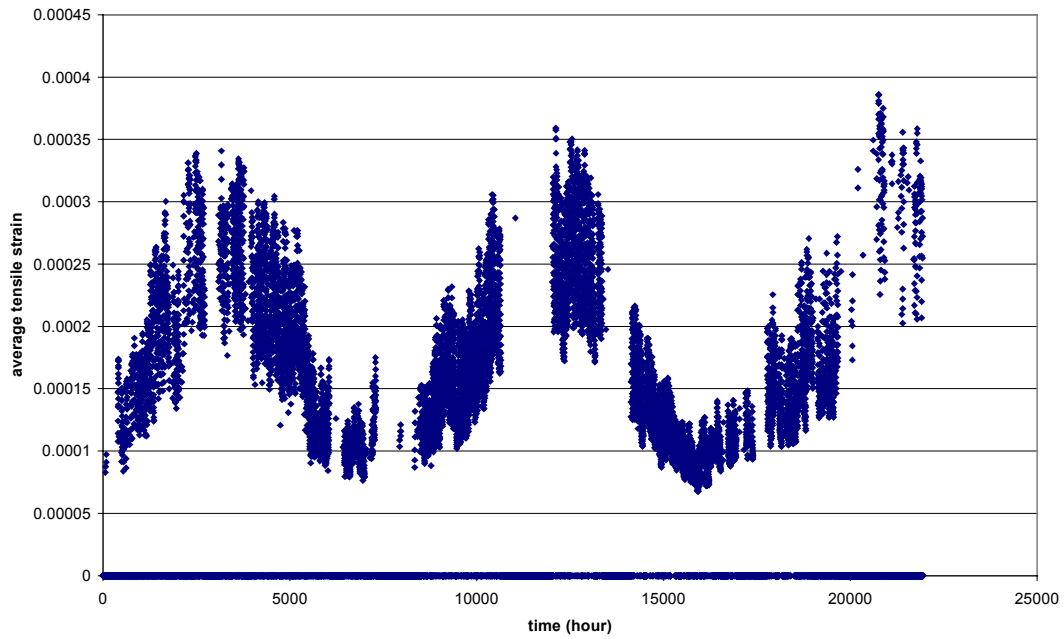
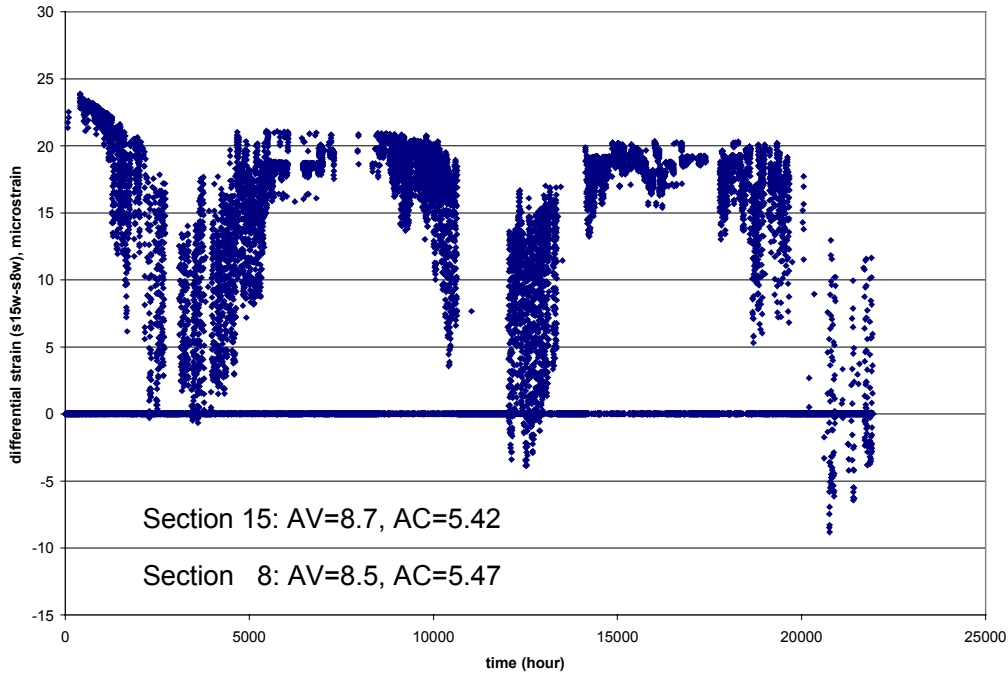
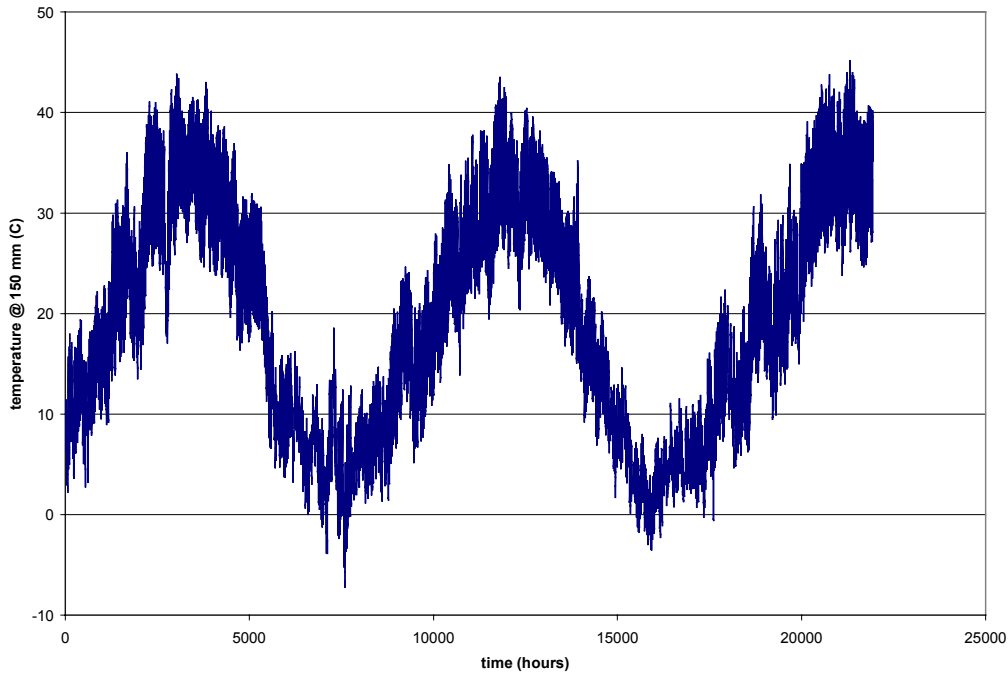

Figure 7.44. Strain history of WesTrack Section 15 with modified traffic pattern.



(a) differential tensile strain



(b) pavement temperature at 150 mm

Figure 7.45. Differential average tensile strain of Section 15 (fine) and Section 8 (coarse) of WesTrack.

AC effect: sec.3,AV=12.4,AC=4.47 (wander)

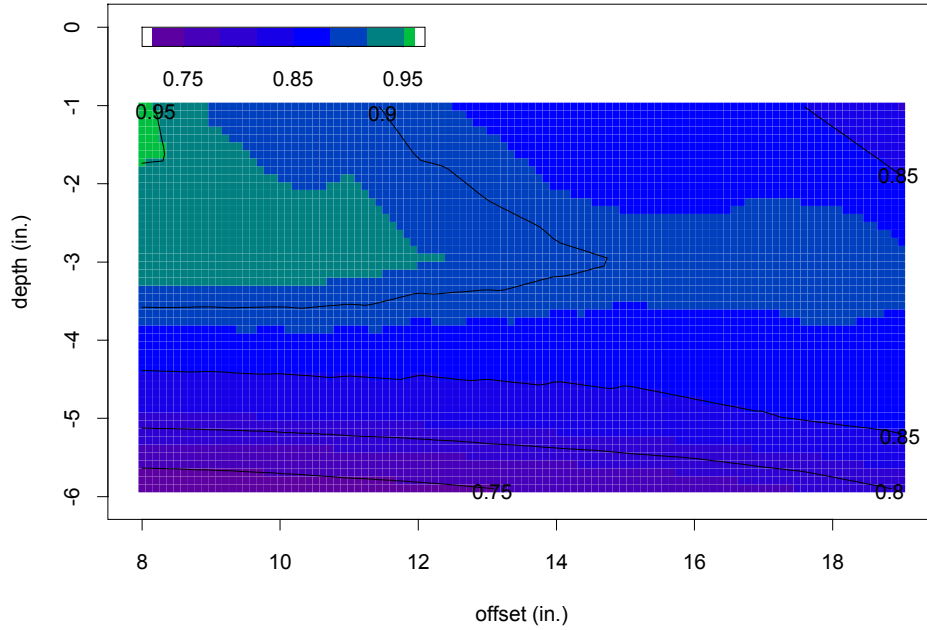

(a)

AC effect: sec.3,AV=12.4,AC=4.47 (no wander)

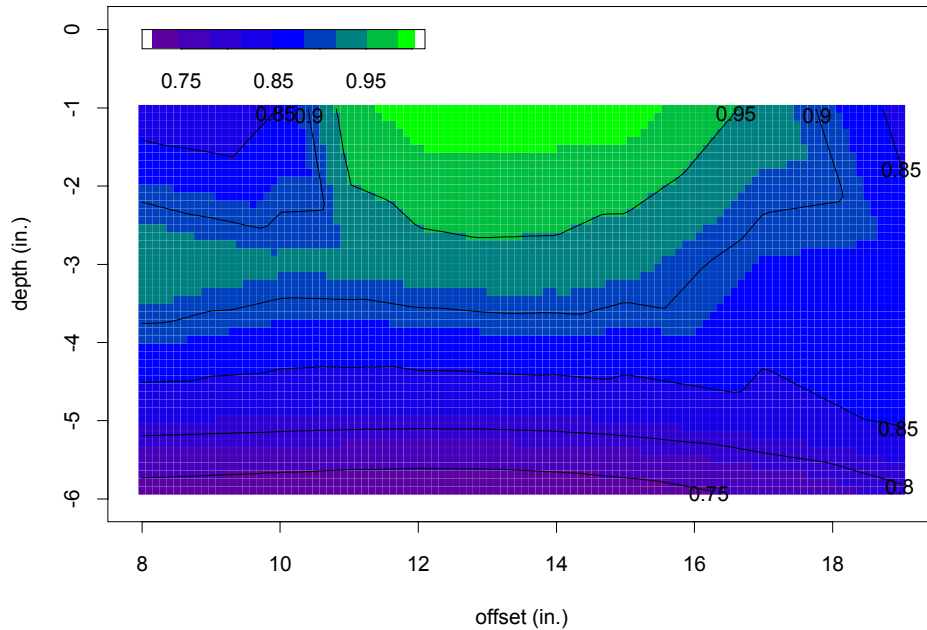

(b)

Figure 7.46. Image-and-contour plot of SR of WesTrack Section 3 with 0.5 % less asphalt content (4.47 %): (a) wander and (b) no wander.

the damage increases (as seen in Figure 7.45). Also, the difference of strains is larger in cold weather than in hot weather.

7.6.3 Asphalt Content

A variation in asphalt content of ± 0.5 percent off the design value was applied to simulations of Sections 3 and 8 in order to simulate fluctuation of asphalt content due to construction variation. The original designed values of asphalt content for Sections 3 and 8 were 4.97 and 5.47 percent, respectively.

Figure 7.46 displays the final pavement deterioration of Section 3 with an asphalt content of 4.47 percent. As compared with the no wander case, the wander case has less fatigue damage along the bottom of the asphalt concrete layer. For this specific traffic pattern, the serious damage of the wander case occurs at a location of offset = 8 inch, depth = 5.99 inch. For the no-wander case, serious damage occurs at a location of offset = 12 inch. The same observation, as visualized in Figure 7.47, is applied to Section 3 with an asphalt content of 5.47 percent. While comparing these two figures, it is found that the Section with less asphalt content has less fatigue damage. When the stiffness deterioration curves with asphalt contents of 4.47, 4.97, and 5.47 percent are plotted together in Figure 7.48, it is easy to identify the effect of asphalt content caused by construction variation. The distance between the wander and no-wander curves seems to be proportional to the value of the asphalt content.

Unlike the clear pavement deterioration patterns of various asphalt contents for Section 3, it is difficult to tell the difference in fatigue damage development along the bottom of the asphalt concrete for the wander and no-wander cases of Section 8, as shown in Figure 7.49 and 7.50. The same conclusion can be drawn if plots are jointly made of the stiffness deterioration curves

AC effect: sec.3,AV=12.4,AC=5.47 (wander)

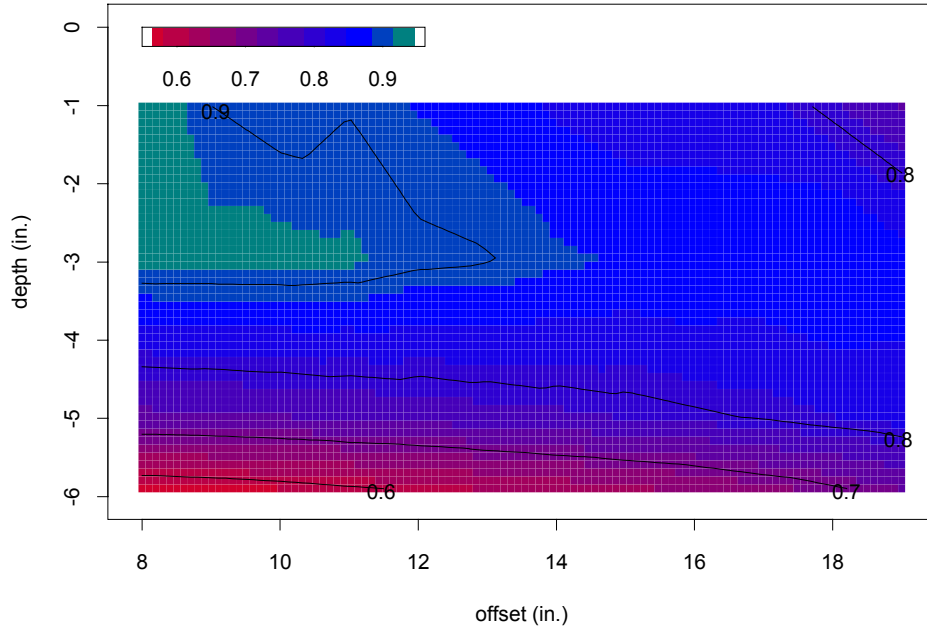

(a)

AC effect: sec.3,AV=12.4,AC=5.47 (no wander)

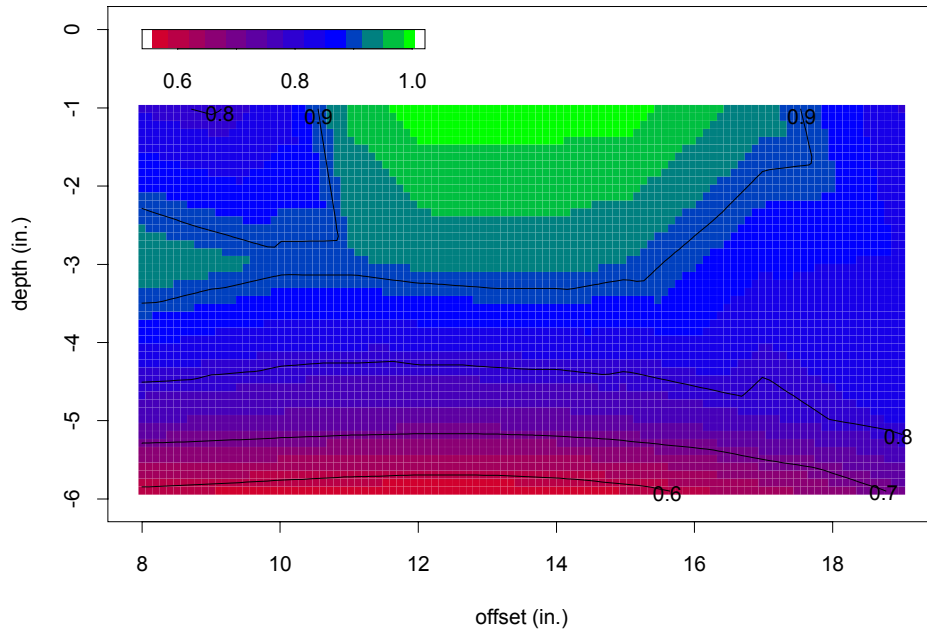

(b)

Figure 7.47. Image-and-contour plot of SR of WesTrack Section 3 with 0.5 % more asphalt content (5.47 %): (a) wander and (b) no wander.

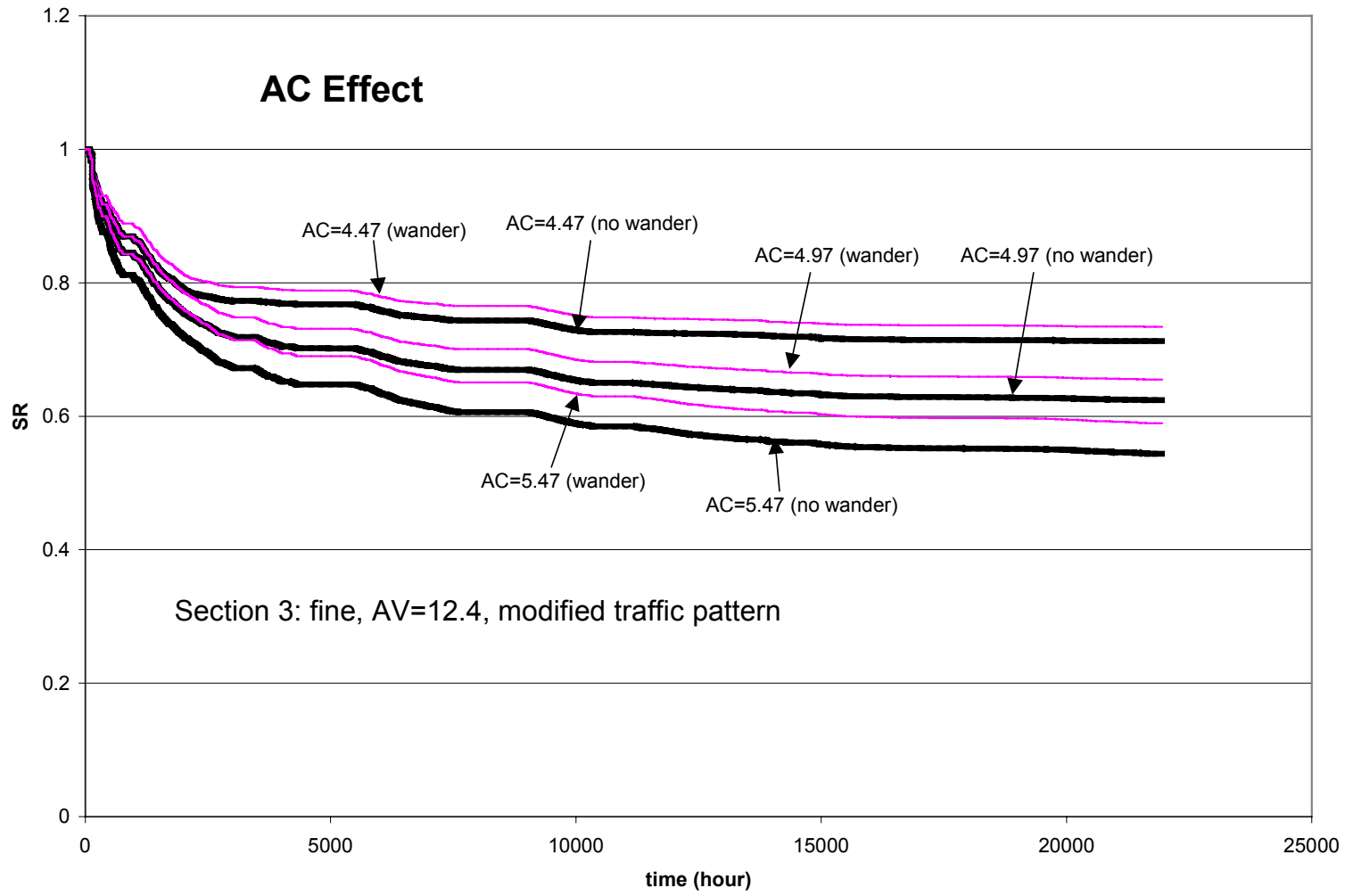
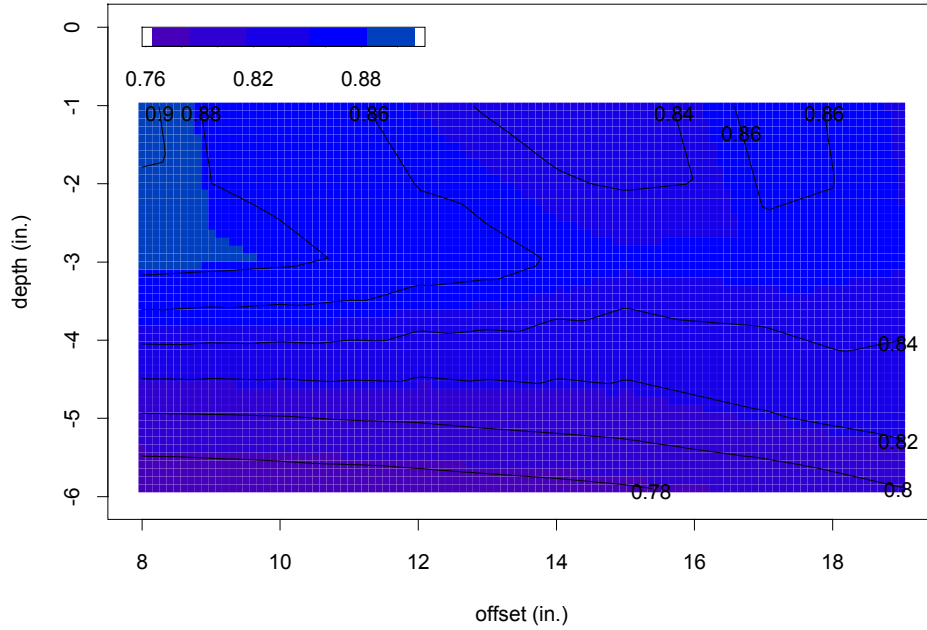

Figure 7.48. Stiffness deterioration curves of WesTrack Section 3 with various asphalt contents.

AC effect: sec.8,AV=8.5,AC=4.97 (wander)



(a)

AC effect: sec.8,AV=8.5,AC=4.97 (no wander)

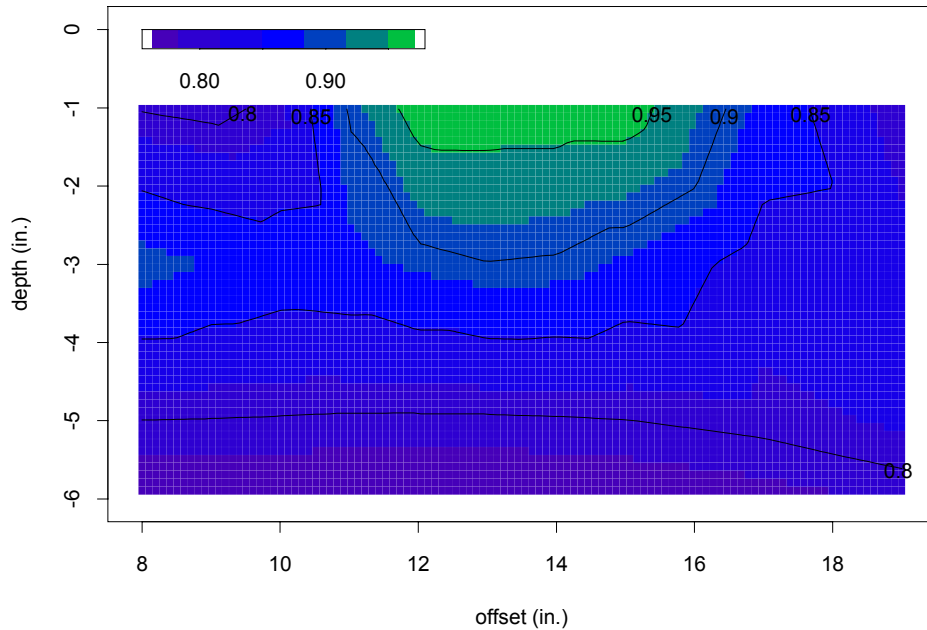

(b)

Figure 7.49. Image-and-contour plots of SR of WesTrack Section 8 with 0.5 % less asphalt content (4.97 %): (a) wander and (b) no wander.

AC effect: sec.8,AV=8.5,AC=5.97 (wander)

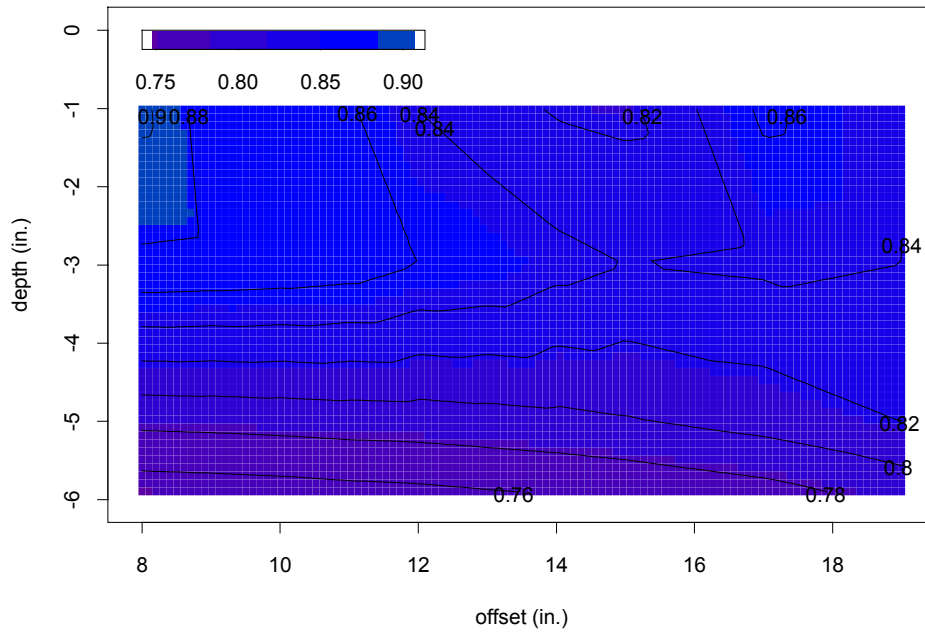

(a)

AC effect: sec.8,AV=8.5,AC=5.97 (no wander)

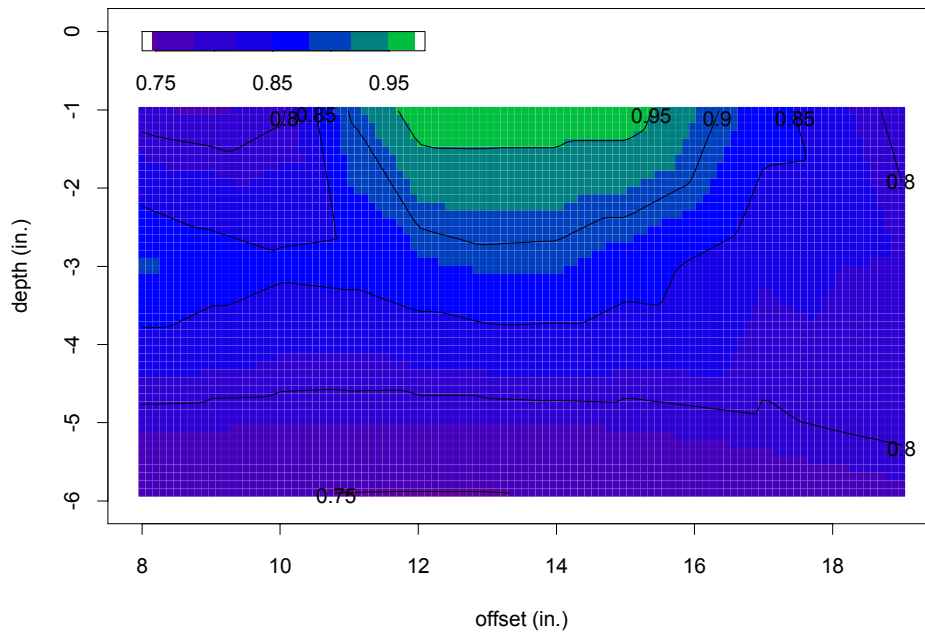

(b)

Figure 7.50. Image-and-contour plots of SR of WesTrack Section 8 with 0.5 % more asphalt content (5.97 %): (a) wander and (b) no wander.

with asphalt contents of 4.97, 5.47, and 5.97 percent. In Figure 7.51, the stiffness deterioration curves with various asphalt contents are overlapped indistinctly. Therefore, the effect of asphalt content to the fatigue performance is definitely mix-dependent.

7.7 Correction Factor and Simulation Results

Accurate prediction of surface cracking due to fatigue damage is the ultimate goal of utilizing the laboratory fatigue test results and conducting a simulation such as the Weibull dynamic approach proposed herein. The use of the correction factor to bridge the difference between laboratory test results and in-situ performance is unavoidable. The crack development due to fatigue damage consists of two phases: crack initiation and crack propagation. Therefore, the correction factors should be applied at each stage, for it is suspected that the mechanism of crack propagation is different from the mechanism of crack initiation. However, at present there is a lack of both an appropriate test setup and the associated fatigue test results for analyzing crack propagation so it is beyond the scope of this research.

Table 7.5, lists the most likely components of a correction factor for the crack initiation and crack propagation. The correction factor for crack initiation can be separated into the following components: temperature, strain, mix properties (mainly the air-void content) or traffic compaction, support conditions, loading frequency, loading configuration, rest period, wander, aging, and water damage. The most significant correction factors for crack propagation might be thermal strain and stiffness damage. In addition, all the factors for crack initiation might apply. However, this needs to be confirmed in future studies.

For every component listed in Table 7.5, a suitable correction factor should be applied in the prediction procedure. Note that the three categories are listed in Table 7.5, namely accelerated controlled-strain laboratory fatigue test, full-scale pavement test, and in-situ

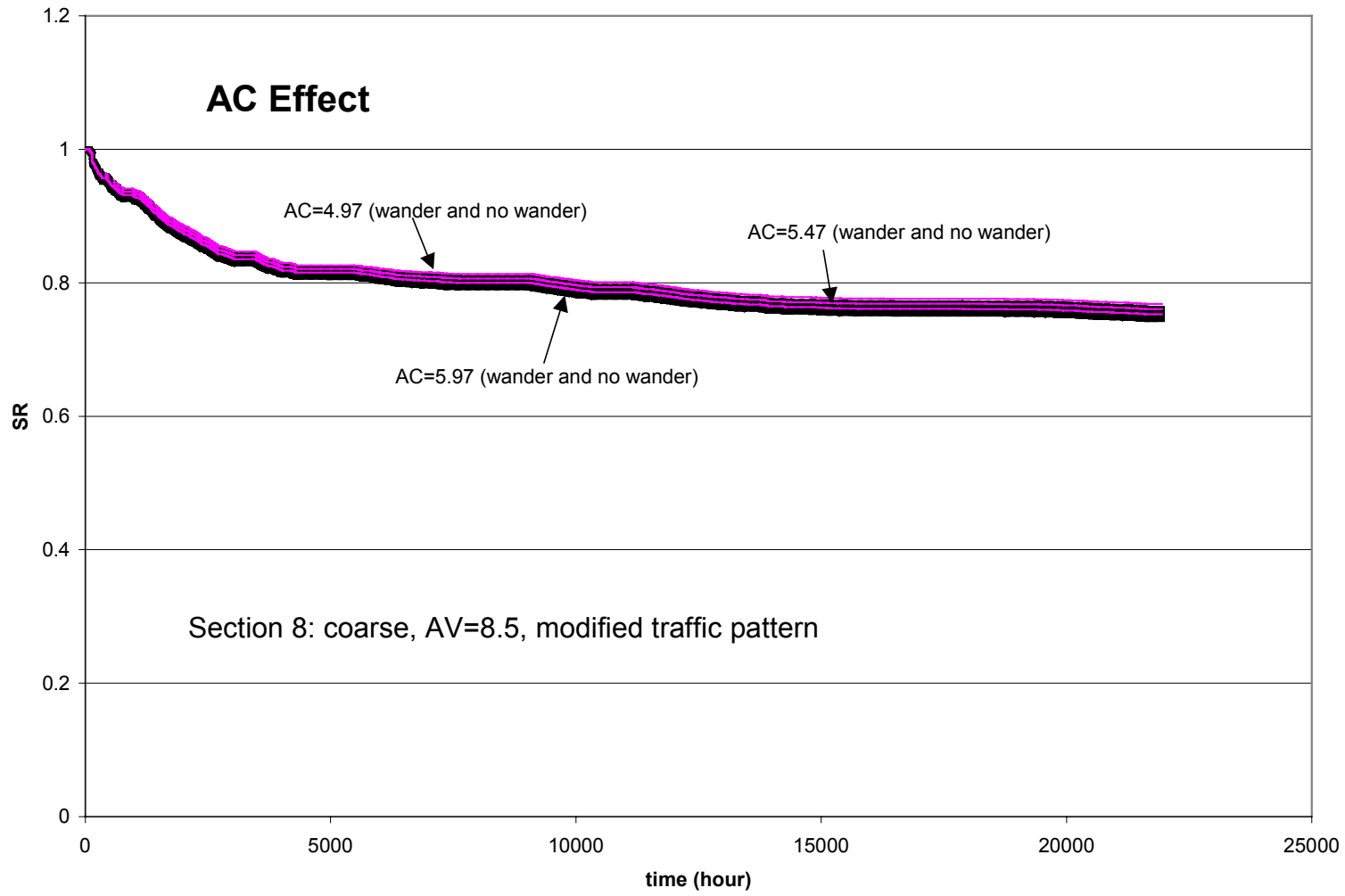

Figure 7.51. Stiffness deterioration curves of WesTrack Section 8 with various asphalt contents.

Table 7.5 Decomposition of Correction Factor

Type	Item	Accelerated controlled-deformation laboratory fatigue test	Full-scale pavement test	In-field pavement
Crack Initiation	Temperature	Well controlled	Can be controlled but has a top to bottom gradient	Can not be controlled and has gradient
	Strain	Well controlled	Can be initially controlled by load but varies due to the stiffness deterioration	Can not be controlled
	Mixture properties (AV) or traffic compaction	Well controlled	Varies due to the traffic compaction	Varies due to the traffic compaction
	Support conditions	Four point simple beam	Layered system	Layered system, subjected to environmental changes
	Loading frequency	Well controlled (usually at 10 Hz)	Can be controlled but it is hard to reach the same frequency as that in laboratory.	varied
	Loading configuration	Can be controlled by stress-controlled test	Can be simulated	Can be monitored
	Rest period	Can be controlled but lose the efficiency and economy	Can be controlled but loss the efficiency and economy	varied
	Wander	Can be simulated by various strains but has limited distribution	Can be simulated directly but has limited distribution	varied
	Aging	Can be simulated by the method of oven aging	Difficult to control	varied
	Water damage	Can be simulated by soaking	Can be controlled	varied
Crack propagation	Thermal loading	To be determined	Can not be controlled but can be monitored	varied
	Other factors	To be determined	To be determined	To be determined

pavement. Generally, the correction factor is applied in one way, i.e., from the laboratory test to full-scale pavement test, from laboratory test to in-situ pavement, or from full-scale pavement to in-situ pavement. It is not reasonable to apply a correction factor in a reverse way such as from in-situ pavement to laboratory test. As for the magnitude of the correction factor, it could be varied component by component and case by case.

If the total correction factor of a simulation case can be represented as a function of various sub-correction factors, i.e., $\phi_{Total} = f(\phi_{ij})$, where $i = 1, \dots, n$ and $j = 1, \dots, n$, assuming that the relationship is restricted to the main effect and two-term interaction effects, then the question raised will be, what are the relationships among the correction factors ϕ_{ij} s? The possible relationship among these correction factors would need to be systematically verified by data from either full-scale pavement testing or an instrumentation-monitored field pavement.

In Chapter 5, a correction factor derived by the Weibull accelerated failure time model is given to indicate the difference caused by the boundary conditions provided that the in-situ fatigue damage also follows the Weibull assumption. Actually, this “boundary conditions” correction factor is an ambiguous aggregated factor. Rather than give the complete details of all correction factors, the purpose of utilizing the Weibull accelerated failure time model is to propose a possible way to correct the “boundary conditions”. The simulation here is restricted to only the correction factor of the “boundary conditions” up to crack initiation, and does not include any correction factor for crack propagation.

The simulations were conducted with Sections 3 and 8 with the correction factors 0.8 and 1.2. The modified traffic pattern and the original weather pattern will be applied in the simulations.

Figure 7.52 plots the final pavement deterioration of SR of Section 3 with a correction factor of 0.8 for both the wander and no-wander cases. Figure 7.53 illustrates the pavement deterioration with a correction factor of 1.2. As visualized in these figures, the higher the value of the correction factor the less the fatigue damage. The corresponding stiffness deterioration curves of Section 3 for various correction factors are displayed in Figure 7.54. The stiffness deterioration curve with a correction factor of 0.8 has an astonishing shape, starting with a sharp drop and then suddenly turning to a flat line around $SR = 0.45$. The smaller correction factor will cause more fatigue damage. Meanwhile, the wander effect is exaggerated by the smaller correction factor.

The same simulation results and conclusions can also be fitted to Section 8. As seen in Figure 7.57, the stiffness deterioration curves for various correction factors, unlike the curves of Section 3, have a mild variation. So, it is believed that the effect of the correction factor is truly mix-dependent. The smaller the correction factor, the greater the wander effect. Figures 7.55 and 7.56 illustrate the final pavement deterioration of SR of Section 8 with the correction factors 0.8 and 1.2, respectively.

As can be seen in the simulations, the correction factor, just like the traffic and weather patterns, has a tremendous effect on the stiffness deterioration curve. More importantly, it is hard to establish any general rule to guide pavement design because the fatigue performance is really affected by all these unavoidable random variables in the correction factors. It should be recognized that the fatigue damage is a stochastic process. Instead of producing a determinate answer to a pavement design question, it should be considered as reliability or risk analysis. Furthermore, since the fatigue damage is a stochastic process, it is better to predict the fatigue

CF effect: sec.3,AV=12.4,AC=4.97,CF=0.8 (wander)

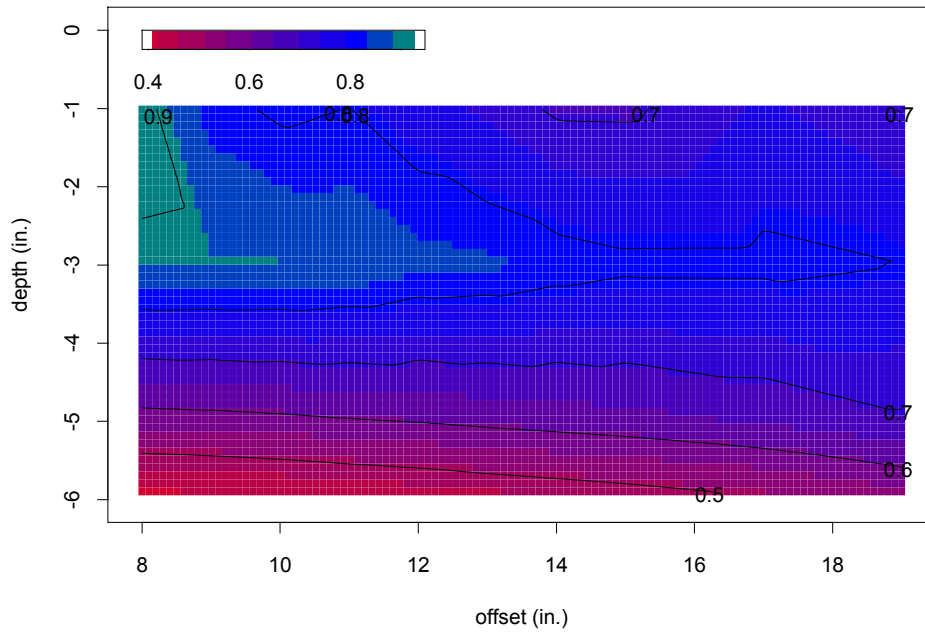

(a)

CF effect: sec.3,AV=12.4,AC=4.97,CF=0.8 (no wander)

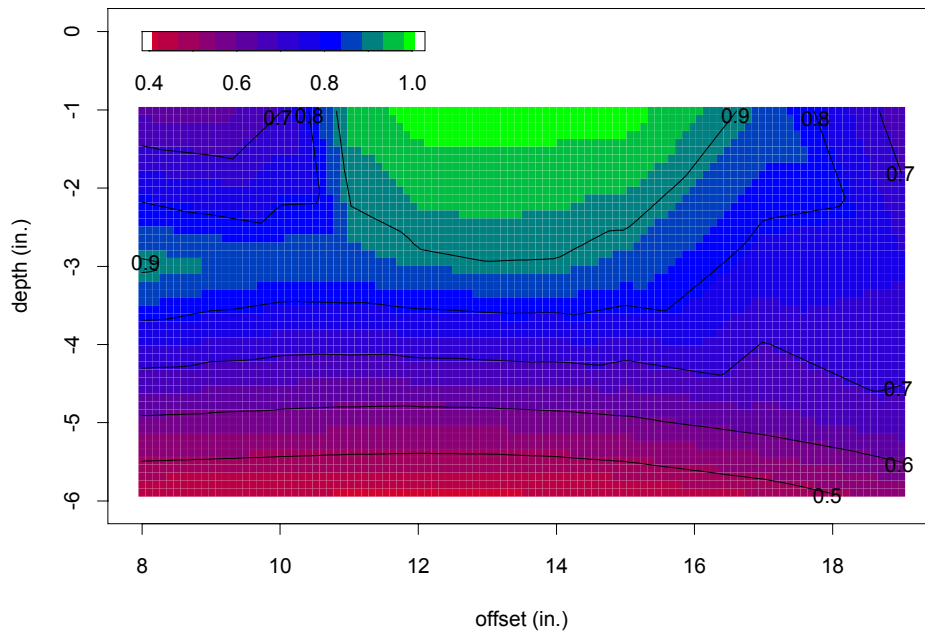

(b)

Figure 7.52. Image-and-contour plots of SR of WesTrack Section 3 with a correction factor of 0.8: (a) wander and (b) no wander.

CF effect: sec.3,AV=12.4,AC=4.97,CF=1.2 (wander)

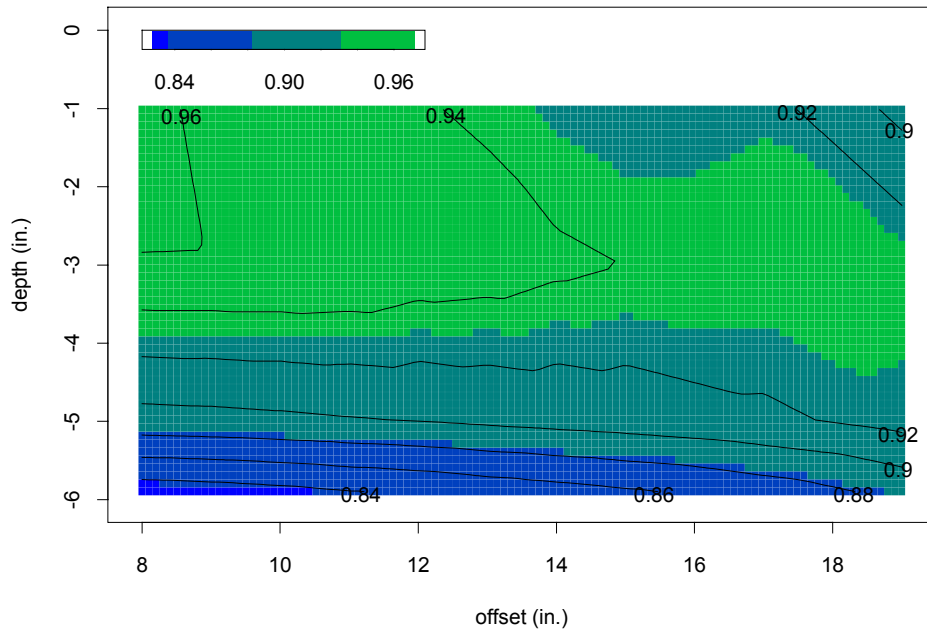

(a)

CF effect: sec.3,AV=12.4,AC=4.97,CF=1.2 (no wander)

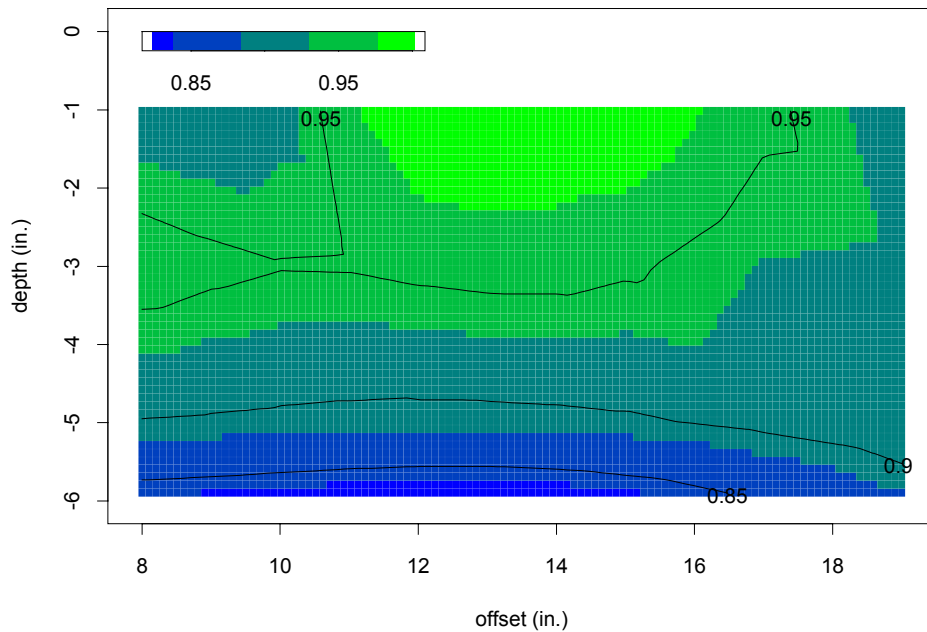

(b)

Figure 7.53. Image-and-contour plots of SR of WesTrack Section 3 with a correction factor of 1.2: (a) wander and (b) no wander.

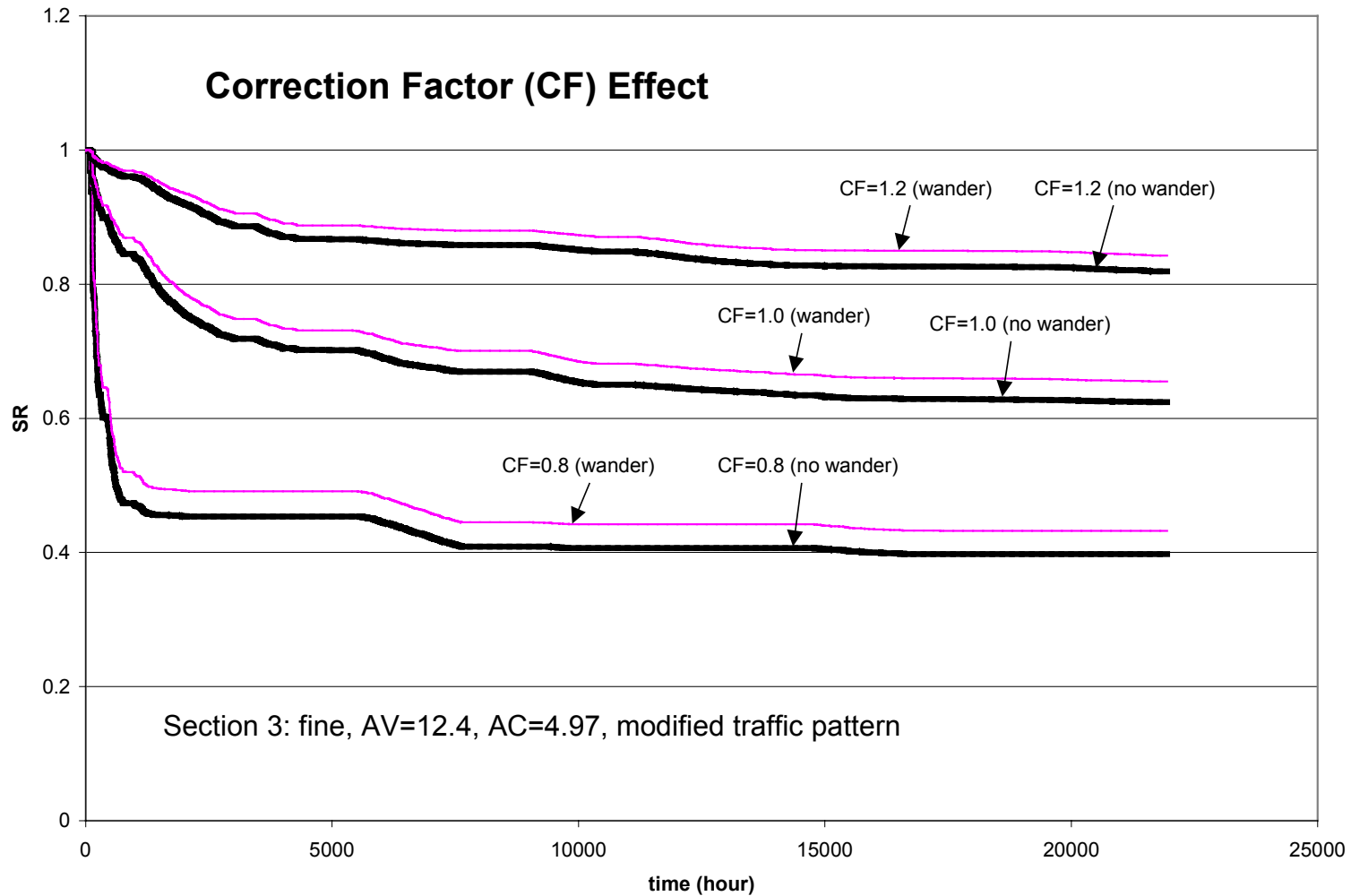
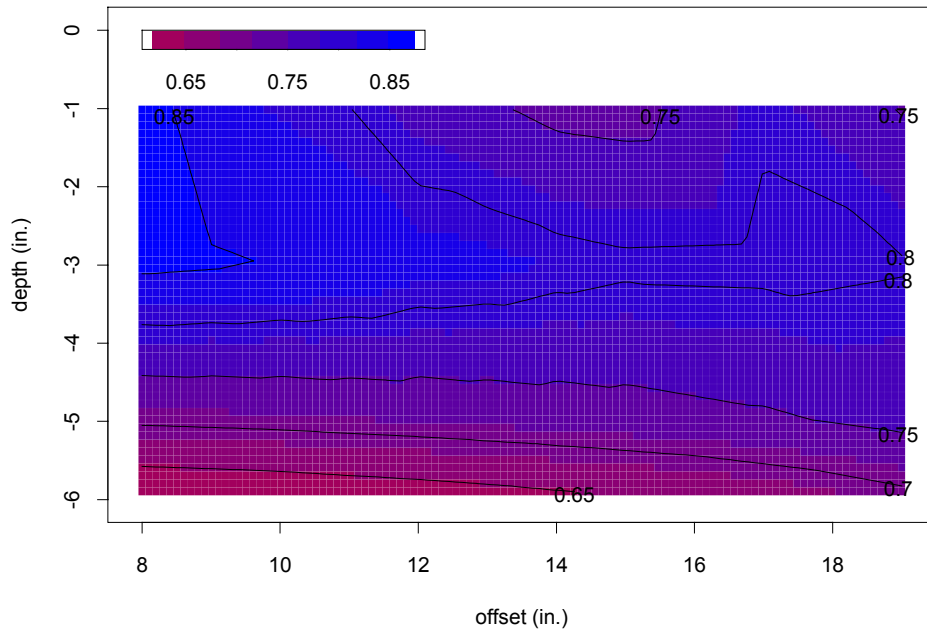

Figure 7.54. Stiffness deterioration curves of WesTrack Section 3 with various correction factors.

CF effect: sec.8,AV=8.5,AC=5.47,CF=0.8 (wander)



(a)

CF effect: sec.8,AV=8.5,AC=5.47,CF=0.8 (no wander)

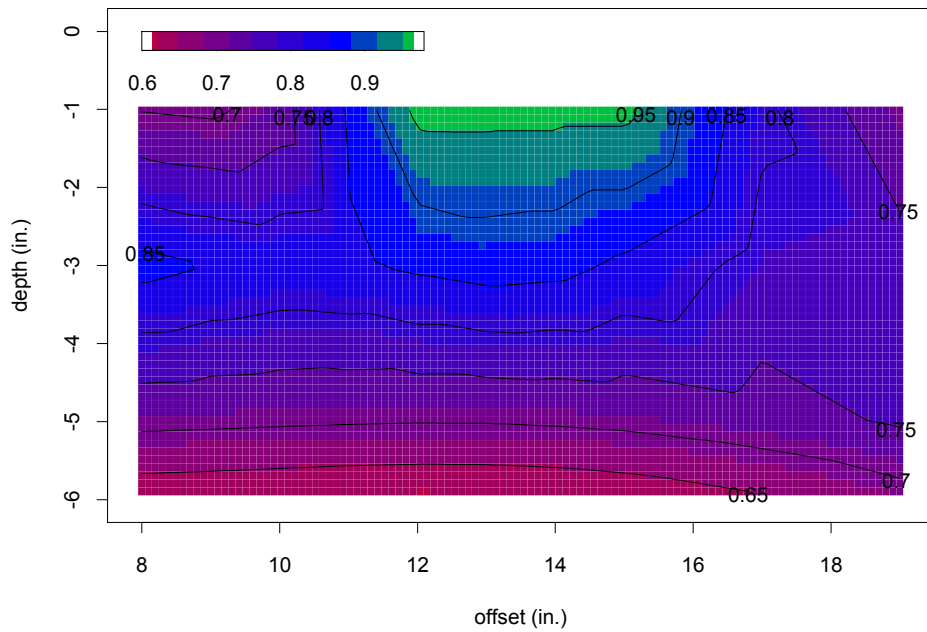

(b)

Figure 7.55. Image-and-contour plots of SR of WesTrack Section 8 with a correction factor of 0.8: (a) wander and (b) no wander.

CF effect: sec.8,AV=8.5,AC=5.47,CF=1.2 (wander)

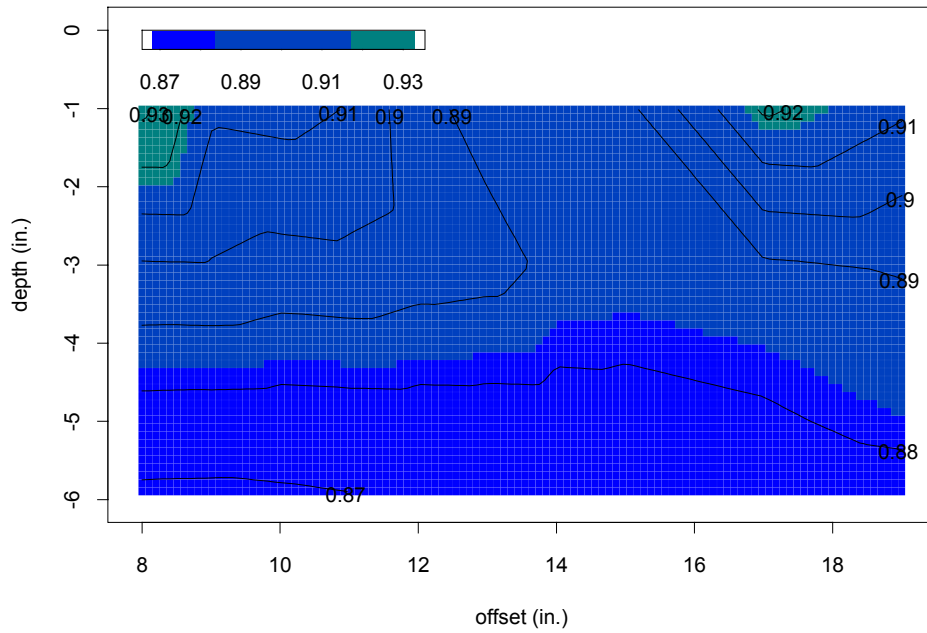

(a)

CF effect: sec.8,AV=8.5,AC=5.47,CF=1.2 (no wander)

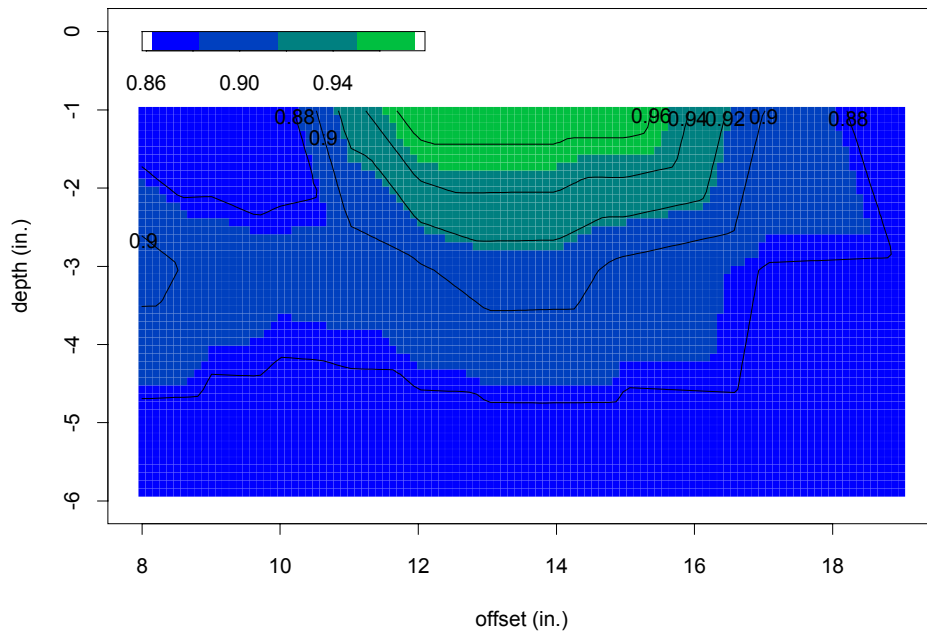

(b)

Figure 7.56. Image-and-contour plots of SR of WesTrack Section 8 with a correction factor of 1.2: (a) wander and (b) no wander.

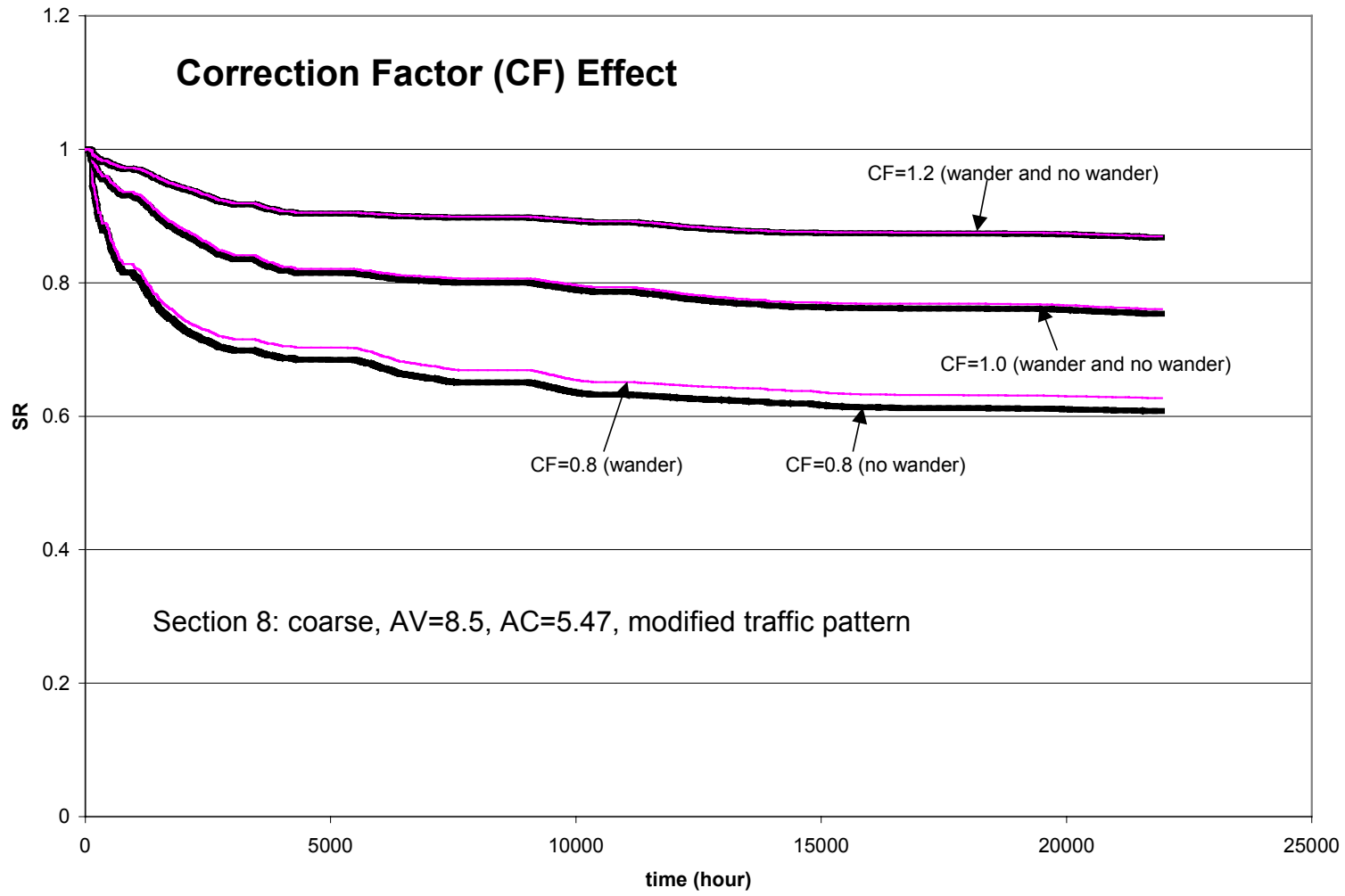

Figure 7.57. Stiffness deterioration curves of WesTrack Section 8 with various correction factors.

performance in a dynamically-simulated way, such as the proposed Weibull dynamic approach, to truly reflect the fluctuations of material and environment variables .

7.8 Findings and Discussions

Findings from the various types of simulations are summarized below. However, bear in mind that the findings made are subject to several limitations of the Weibull program, such as: (1) a crack propagation model is not included, (2) it uses one stiffness to represent the stiffness of an entire layer, and (3) the correction factor is set to be 1.0 for simulations because of lack of information.

1. Wander effect is mix-dependent, traffic-dependent, and also time-dependent.

However, it is shown that the wander effect is not weather-dependent in the simulations of the two WesTrack Sections 3 and 8.

2. One problem encountered with use of the Weibull program is that the linear-elastic layered program ELSYM5 only accepts one stiffness value for representing the stiffness of the entire layer. This does not comply with the fact that the degree of stiffness deterioration varies point-by-point in the in-situ pavement. But, it is possible to read in multiple ELSYM5 input files and use the strain engine as necessary to conduct a finite-element-method-like performance. However, it looks awkward as compared with the average strain in the current version of the Weibull program. The best solution is to replace the ELSYM5 strain engine with a finite element strain engine and incorporate the necessary information on stiffness deterioration, especially the crack propagation, in the simulation program. However, the most important task following this study should be the development of a model of crack propagation. In addition, it was found that the simulation result is sensitive to the stiffness equations

obtained from the regression analysis. To improve the accuracy of simulation results, it is important to carefully assess the stiffness equation, especially at high temperatures.

3. The correction factors need to be found from field data. The correction factor derived from the Weibull accelerated failure time model needs to be further verified. A combination model of crack initiation and crack propagation is needed.
4. Theoretically (from the simulation results), the coarse mixes seem to have the better capacity to resist the thickness effect, the traffic effect, and the weather effect, however, this is contradicted in practice. From the condition survey data, it was noted that several coarse sections had severe cracking in the first winter. The field observation indicates the importance of including the crack propagation model in the Weibull dynamic approach.

8.0 CONCLUSIONS AND RECOMMENDATIONS

Several conclusions can be drawn and observations made from the results of this study. A discussion of these follows.

8.1 Are there primary rules of fatigue performance for asphalt-aggregate mixes?

From the fatigue test results of this study, it has been recognized that the effect of temperature on stiffness is like the effect of strain level on fatigue life. Both temperature and strain level are two fundamental and dominant factors that affect the fatigue performance as verified by the identification procedure in Chapter 4.2 and the model selection procedure in Chapter 4.8. These two factors are usually categorized as the environmental and traffic factors. It would appear that the environmental factors have more of an effect on the fatigue performance than do the material variables. The Weibull simulations with various traffic and weather patterns run in Chapter 7 have proved this statement. Because traffic and weather patterns usually have randomness as one of their characteristics, it makes statistical analysis a necessary tool for predicting the fatigue performance of an field pavement.

8.2 Is the Weibull function the unique solution to describe fatigue damage process?

To employ the Weibull function in describing the stiffness deterioration process of the simple fatigue test is quite appropriate and successful, especially in the phase of crack initiation, as is demonstrated in this study. In this study, the focus has been on utilizing the Weibull function to predict the fatigue performance of asphalt concrete. However, the Weibull function is only one example of the various functions that can be used to describe the stiffness deterioration.

8.3 What is learned from the Weibull simulations of WesTrack?

In spite of the fact that (1) the current version of the *Weibull* program does not include a program module for predicting crack propagation, (2) although the program is capable of reading the change in air-void content caused by the traffic compaction, it is not considered in the simulation, and (3) all the correction factors are not yet fully identified, the lessons learned from the Weibull simulations of the WesTrack sections can be summarized as follows:

1. The wander effect is dependent on the asphalt-aggregate mix, traffic pattern, and weather pattern.
2. The stiffness deterioration of pavement is affected not only by the traffic pattern, but also by the weather pattern.
3. For the WesTrack project, with a design life of only two years, the starting traffic time seems to be very important to the fatigue damage process as demonstrated in the weather effect of Chapter 7. However, for a pavement with a design life of, for example, 20 years or longer, more data are needed to support this statement.
4. The stiffness deterioration curves are proportionally affected by the percent air-void content. The higher the air-void content, the faster the stiffness deterioration. Hence, control of the compaction is an important factor that will need to be considered during construction.
5. It is necessary to fully understand the correction factors bridging the laboratory test results and the in-situ pavement performance. More importantly, those correction factors needed for crack initiation and crack propagation are deserving of further study.

8.4 “Miner’s Approach” or the “Weibull Approach”?

That the stiffness deterioration is not included in the consideration of cumulative fatigue damage is the major disadvantage of Miner’s approach. As a consequence of not including the stiffness deterioration, it is conjectured that the wander effect in Miner’s approach, as seen in Chapter 6, is conservatively overestimated. Therefore, it would be better to integrate a stiffness deterioration equation with the strain function (Chapter 6) to modify the strain change due to the stiffness deterioration and thus ensure a more practical estimate of fatigue damage.

Although the Weibull dynamic approach has no such problems, it presents another problem: that a suitable correction factor must be provided to obtain a good prediction. The other disadvantage of the Weibull dynamic approach that can also be improved upon in the future is that, at present, the approach is limited to predicting only crack initiation, but could predict crack propagation with the addition of a crack propagation model. A combination model for both crack initiation and crack propagation would be more reasonable and ultimately more meaningful to pavement design. The combination model can be set up in such a way that the crack propagation model will be triggered once the crack initiation has finished developing, i.e., when the stiffness ratio reaches a predefined failure criterion for crack initiation.

In addition, another issue raised is that, from the Weibull simulation of the WesTrack sections, it turns out that the fatigue damage caused by either wander traffic loading or no-wander traffic loading had no significant effect at the bottom of the asphalt concrete. This differs from the conclusion obtained from Miner’s approach to the wander effect. Several possible factors could explain this result. One that has been suggested is that the narrow wander range, from 5 inches left to 5 inches right, produces no obvious discrepancies in fatigue damage at the bottom of the asphalt concrete layer. Another possibility, supported by the results of this study, is that the one-tenth of total traffic applied at the central position in the early stage of

trafficking compromised the overall wander effect. Corroborating evidence for this is evident from the simulations of the original traffic pattern and a modified traffic pattern (Chapter 7). The Weibull approach demonstrates a greater capability of accuracy in estimating wander effect than does Miner's approach in this regard.

Another advantage of the Weibull dynamic approach over Miner's approach is in the application to a Pavement Management System. The use of the Weibull approach gives intermediate steps along the life in a more appropriate curve rather than the straight line given by Miner's approach. Therefore, the Weibull dynamic approach can be used to account for traffic and weather effects each year in estimating damage and time to maintenance.

However, one thing common to both these approaches is that a shift factor (or correction factor) is required when applying the laboratory fatigue test results in predicting the fatigue performance of an in-situ pavement. Therefore, neither the "Miner's approach" nor the "Weibull dynamic approach" can give satisfactory prediction results at present. Extra effort and further study are needed to address the aforementioned drawbacks of these two approaches.

8.5 Will the rutting mechanism interact with the fatigue mechanism?

At present, rutting and fatigue failure are treated separately in the design phase. Many researchers claim that rutting only occurs at the top part of the asphalt concrete layer and thus could not interact with the bottom-up type of fatigue failure. It is believed by the author that this interaction of rutting and fatigue damage definitely exists and that both should be considered simultaneously during the design phase. The "rich-bottom" design philosophy (Harvey 1997) is a good example of trying to satisfy the criteria of both fatigue and rutting. One of the reasons for rutting is the structural damage done to the base or subgrade. The displacement of the pavement structure results in a redistribution of stresses and thus accelerates the fatigue damage. This

could be likened to conducting a fatigue test on a crooked beam. Therefore, it is felt that further study of the interaction between these two mechanisms is worthwhile.

8.6 Is the correction factor important to fatigue performance prediction?

The answer is unequivocally yes. The correction factor, which is here suggested be obtained from the Weibull accelerated failure time model, compensates for differences of boundary conditions between the laboratory and field and actually plays a greater role in fatigue performance prediction than does the accurateness of Weibull equations. As demonstrated in Chapter 7, the effect of the correction factor on the fatigue damage is much greater than the effect caused by the variation of mix properties.

In addition to the correction factor modified for boundary conditions, other correction factors exist that are also very important to the fatigue performance prediction as indicated in Table 7.5. The correction factor for boundary conditions will vary with weather annually, but can be updated. However, the data for calibrating the correction factor is usually very difficult to measure or obtain. This study author focused on the correction factor as pertaining to differences in boundary conditions. This is definitely not enough to describe the actual correction factor. To include the many other possible influences will be difficult if not impossible.

The beauty of applying the Weibull proportional hazards model to fatigue performance prediction is that the regression equation obtained from the model can represent all the laboratory stiffness deterioration curves for any testing situation. Of course, the area of examination should be bounded by the parameters of the data range. This advantage makes it possible to digitize the phenomena of stiffness deterioration at different situations and have it easily coded.

The correction factor could be a lump sum effect including not only the boundary condition difference but also the effect caused by the rest period between traffic.

8.7 Can the crack propagation model be an extension model of crack initiation?

The question raised here is still confined by the limits of the bottom-up type of cracking. From the Weibull curves ($\ln(-\ln(SR))$ versus $\ln(\ln(n))$ or $\ln(n)$), or the plot of cumulative dissipated energy versus repetition, it is demonstrated that the SR and the cumulative rate of dissipated energy obviously change when the macro-crack is suspected of starting to propagate.

Unfortunately, the crack propagation model is not included in this study and most of the time it is difficult to determine the crack initiation time in the field for bottom-up cracking. One can only guess that the crack initiation time should occur before any surface cracking develops. Thus, it is necessary to establish the crack propagation model and integrate it into the proposed Weibull dynamic approach to get a better prediction of the fatigue performance. Then the crack propagation mechanism could be triggered once the phase of crack initiation has been developed.

Although the mechanisms of crack initiation and crack propagation cannot be treated equally, it is possible to integrate the associated statistical models of both mechanisms into a decision model that can determine when the correct model, initiation or propagation, should be triggered. In previous discussion of WesTrack simulations, the described methodology misses in the prediction of crack propagation, especially in cold weather. Therefore, a better approach would include both mechanisms, if the methodology to predict crack propagation is available, and trigger either one or both of the mechanisms depending on the situation that applies.

8.8 Is the Weibull dynamic approach the “poor man’s” Finite Element Method?

The Weibull dynamic approach introduced in this study utilizes ELSYM5, a linear layered-elastic program, as the strain engine and then applies the Weibull proportional hazards model from the laboratory fatigue test results to dynamically modify the layer stiffness. The methodology is, in essence, an empirical-mechanistic approach. Many researchers now question

the applicability of the linear layered-elastic theory to pavement design. Instead, serious consideration has been given to the viscoelasticity of asphalt concrete behavior. Using the linear elastic layer theory in pavement performance prediction as done in this study, in the opinion of the author, does not seem to introduce a lot of error.

Considered another way, even if the asphalt concrete does behave as a viscoelastic material, (or a viscoplastic material, or any other similar term), all these terms can be categorized into the “nonlinear” domain. A nonlinear relationship can be seen as a consecutive set of piecewise linear events. At any instant of the material’s life, it encounters a specific conditions, i.e., fixed air-void content, asphalt content, temperature, traffic loading, loading time, moisture, etc. And for each specific instant, a linear approach based on that specific condition should be more than enough. The key to successfully applying the linear layered-elastic theory lies in the thorough knowledge of structure deterioration. If such information is not provided, then even applying the FEM and conducting a real mechanistic analysis still cannot provide a good design.

8.9 “Time Hardening” or “Strain-Hardening” or both or...?

This is a difficult question to answer. The results of the varied-strain and the varied-temperature fatigue tests agree with the postulated hypotheses to a certain degree and so the “Strain-Hardening” procedure has been applied and coded for the Weibull dynamic approach. However, it would be premature to draw any serious conclusion or theorem from these limited tests about whether the “Time-Hardening” procedure or the “Strain-Hardening” procedure should be adopted in describing the change of fatigue damage process due to the change of environmental variables. The issue of whether the change in fatigue damage process is caused by the change of environmental variables should be treated cautiously. The extent to which the behavior of the fatigue damage process as subjected to traffic and environmental variables is

understood will affect the accuracy and correctness of the algorithm of the simulation program. The varied-temperature and varied-strain fatigue test methods utilized here are only a beginning. More advanced and refined test methods should be developed and pursued.

8.10 “Problem solving” or “Problem making”?

It seems that this study raises more unanswered than answered questions.

This study found that the Weibull function and Weibull Proportional Hazards model are tenable to describe the crack initiation phase until observable macro-crack propagation. As for the crack propagation, an advanced testing method and an appropriate model need to be further developed and evaluated. The combination of the crack initiation model, as the proposed Weibull dynamic approach, and the crack propagation model should also be a future goal. The correction factor introduced by the Weibull accelerated failure time model, with the primary purpose of separating the boundary condition from the laboratory test setup and field condition, is too broad to identify and control all contributing sources.

8.11 Next Step?

Many problems and questions have been identified in this study. From all these problems and questions, what should be the next step towards developing a more comprehensive yet effective approach to predicting fatigue performance and, if possible, surface cracking? In the opinion of the author, several tasks can be focused on in the future:

- Continue to study the high temperature fatigue test, including more mix variables and improving the test setup.

- Conduct more studies of the fatigue damage process through advanced varied-temperature and varied-strain fatigue tests (or even just better experiment designs).
- Implement a new experiment design for the crack propagation.
- Propose a combination model of crack initiation and crack propagation.
- Carry out a thorough study of correction factors and identify each associated component.
- Build a better strain engine, for instance, the FEAP (Taylor 1998) or ILLI-PAVE (Wilson 1965, Barksdale 1969, Duncan 1968) finite element program, in order to obtain a better estimation of the stress and strain relationship (provided the structure deterioration information is available).
- Incorporate more traffic-related variables into the Weibull dynamic approach, such as vehicle speed, head time, traffic composition, etc.
- Improve the in-field stiffness measuring devices (non-destructive stiffness measurement) and the back calculation methodology.
- Apply the Weibull dynamic approach to pavement design, incorporate it into the risk analyses of a Pavement Management System, use it as an aid to decision making in pavement maintenance, and include it in quality control and quality assurance programs.

REFERENCES

- AASHO (1962), *Special Report 61-G: The AASHO Road Test, Report 7*, HRB, National Research Council, Washington, D.C. *Special Report 73: The AASHO Road Test*, HRB, National Research Council, Washington, D.C.
- AASHTO (1996), *June 1996 AASHTO Provisional Standards*, Provisional Standard MP 1, *American Association of State Highway and Transportation Officials*, Washington, D.C.
- Ahlborn, G. (1972), *ELSYM5: Computer Program for Determining Stresses and Deformations in Five Layer Elastic System*, University of California, Berkeley.
- Allen, D.L. (1979), *Determination of Rutting in Asphaltic Concrete Pavements: Field Instrumentation and Laboratory Characterizations*, Kentucky Department of Transportation.
- Asphalt Institute (1981), *Thickness Design Manual (MS-1)*, 9th ed., *The Asphalt Institute*, College Park, Md.
- Barksdale, R.D. (1969), *Analysis of Layered System*, School of Civil Engineering, Georgia Institute of Technology, Atlanta.
- Bogdanoff, J.L., and F. Kozin (1985), *Probabilistic Models of Cumulative Damage*, John Wiley & Sons.
- Burmister, D.M. (1945), "The General Theory of Stresses and Displacements in Layered Systems," *Journal of Applied Physics*, Vol. 15.
- Caltrans (1991), *Highway Design Manual*, Section 600, California Department of Transportation, Sacramento.
- Caltrans (1995), *CAL/APT Strategic Plan (July 1995-July 1997)*, adopted by the CAL/APT Steering Committee, California Department of Transportation, May 18.
- Chen, S.S. (1987), *The Response of Multi-Layered System to Dynamic Surface Loads*, Doctoral Dissertation. Department of Civil Engineering, University of California, Berkeley.
- Chomton, G. and P.J. Valayer (1972), "Applied Rheology of Asphalt Mixes, Practical Applications," *Proceedings, Third International Conference on the Structural Design of Asphalt Pavements*, London, Sept. 1972, Vol. 1, p.214.
- Collett, D. (1994), *Modelling Survival Data in Medical Research*, Chapman & Hall, 1st edition.
- Collop, A.C. (1994), *Effects of Traffic and Temperature on Flexible Pavement Wear*, Ph.D. Thesis, Engrg. Dept., Cambridge University, Cambridge, England.

- Cox, D.R. (1972), "Regression Models and Life Tables (with discussion)," *Journal of the Royal Statistical Society*, B, 74, pp. 187-220.
- Croney, D. (1990). "Is the measured deflection of a flexible pavement a reliable guide to life prediction and overlay design." *Highways*, Surrey, England, 58(part 1968), 24-26.
- CSIR (1995), *Guideline to the Use and Operation of the Heavy Vehicle Simulator (HVS)*, Council for Scientific and Industrial Research (CSIR), Pretoria, South Africa.
- Dai, S.T., et al. (1997), "Investigation of Flexural Pavement Response to Truck Speed and FWD Load Through Instrumented Pavements," *Proceedings, Eighth International Conference of Asphalt Pavements*, University of Washington, Volume I, August 10 through 14.
- Deacon, J.A. (1965), *Fatigue of Asphalt Concrete*, Ph.D. Dissertation, University of California, Berkeley.
- Deacon, J.A., A. Tayebali, J. Coplantz, F. Finn, and C.L. Monismith (1994), "Fatigue Response of Asphalt-Aggregate Mixes, Part III—Mix Design and Analysis," Strategic Highway Research Program Report No. SHRP-A-404, National Research Council, Washington, D.C.
- Deacon, J.A. (1998), Internal Memorandum, Pavement Research Center, Institute of Transportation Studies, University of California, Berkeley.
- Del Valle, H.F. (1985), "Procedure—Bulk Specific Gravity of Compacted Bituminous Mixtures Using Parafilm-Coated Specimens," Chevron Research Company, Richmond, California.
- Duncan, J.M., C.L. Monismith, and E.L. Wilson (1968), "Finite Element Analysis of Pavements," *Research Record No. 228*, Highway Research Board.
- Epps, J.A. (1968), *Influence of Mixture Variables on the Flexural Fatigue and Tensile Properties of Asphalt Concrete*, Ph.D. Dissertation, University of California, Berkeley.
- Ferry, J.D. (1980), *Viscoelastic Properties of Polymeric Material*, Wiley, NY.
- Finn, F.N., C. Saraf, R. Kulkarni, K. Nair, W. Smith, and A. Abdullah (1977), "The Use of Prediction Subsystems for the Design of Pavement Structure," *Proceedings, Fourth International Conference on Structural Design of Asphalt Pavements*, pp.3-38.
- Finn, F.N. and J.A. Epps (1980), *Pavement Failure Analysis with Guidelines for Rehabilitation of Flexible Pavements*, Research Report 214-17, Texas Transportation Institute, The Texas A&M University System, College Station, Texas.

- Garcia-Diaz, A., M. Riggins, S.J. Liu (1984), *Development of Performance Equations and Survivor Curves for Flexible Pavements*, conducted for the Texas State Department of Highways and Public Transportation, Research report (Texas Transportation Institute), no. 284-5.
- Gere, J.M. and S.P. Timoshenko (1984), *Mechanics of Materials*, 2nd edition.
- Gerritsen, A.H. and R.C. Koole (1987), “Seven Years Experience with the Structural Aspects of SHELL Pavement Design Manual,” *Proceedings, 6th International Conference on the Structural Design of Asphalt Pavements*, Ann Arbor, Michigan.
- Hand, Adam J.T. (1998), *Relationships between Laboratory Measured HMA Material and Mixture Properties and Pavement Performance at WesTrack*, Ph.D. Dissertation, University of Nevada, Reno.
- Harvey, J., D. Huang, J. Prozzi, L. Louw, C. Scheffy, and I. Guada (1997), *CAL/APT Program: Test Results from Accelerated Pavement Test on Pavement Structure Containing Untreated Aggregate Base—Section 503RF*. Draft report submitted to California Department of Transportation. Pavement Research Center, CAL/APT Program, Institute of Transportation Studies, University of California, Berkeley, December.
- Harvey, J.T. (1992), *Mix Design Compaction Procedures for Hot-Mix Asphalt Concrete and Rubber-Modified Asphalt Concrete Mixtures*, Ph.D. Dissertation, University of California, Berkeley.
- Harvey, J.T., B. Tsai (1996), “Effect of Asphalt Content and Air Void Content on Mix Fatigue and Stiffness,” *Transportation Research Board 1543*, TRB, National Research Council, Washington, D.C., pp. 38-45.
- Harvey, J.T., J.A. Deacon, A.A. Tayebali, R.B. Leahy, and C.L. Monismith (1997), “A Reliability—Based Mix Design and Analysis System for Mitigating Fatigue Distress,” *Proceedings, 8th International Conference on Asphalt Pavements*, Seattle, Washington, August, Volume 1, pp. 301-323.
- HDM-4 (1997), “HDM-4 Technical User Guide, Part D: Models, D-1 Road Deterioration (Flexible Pavement),” June.
- Hofstra, A. and C.P. Valkering (1972), “The Modulus of Asphalt at High Temperatures: Comparison of Laboratory Measurement under Simulated Traffic Conditions with Theory.” *Proceedings, Third International Conference on the Structural Design of Asphalt Pavements*, University of Michigan, Ann Arbor, September, pp.430-443.
- Huang, Yang H. (1993), *Pavement Analysis and Design*, Prentice Hall.
- Hveem, F.N. (1955), “Pavement Deflections and Fatigue Failures,” *Bulletin 114 HRB*, National Research Council, Washington, D.C., pp. 43-87.

- Ioannides, A.M. (1997), "Pavement Fatigue Concepts: A Historical Review," *Proceedings, 6th International Conference on Concrete Pavement Design and Materials for High Performance*, Purdue University, Indianapolis, Indiana, pp. 147-60.
- Kennedy, T.W., G.A. Huber, E.G. Harrigan, R.J. Cominsky, C.S. Hughes, H. Von Quintas, and J.S. Moulthrop (1994), *Superior Performing Asphalt Pavements (Superpave): The Product of the SHRP Asphalt Research Program*, SHRP-A-410, Strategic Highway Research Program, National Research Council, Washington, D.C.
- Kim, Y., and Y.R. Kim (1997), "In Situ Evaluation of Fatigue Damage Growth and Healing of Asphalt Concrete Pavements Using Stress Wave Method", *Transportation Research Record 1568*, Washington, D.C.
- Little, D.N., et al. (1997), "Propagation and Healing of Microcracks in Asphalt Concrete and Their Contributions to Fatigue," *Asphalt Science and Technology* edited by Arthur M. Usmani, pp.149-195.
- Majidzadeh, K., E.M. Kauffmann, and D.V. Ramsamooj (1971), "Application of Fracture Mechanics in the Analysis of Pavement Fatigue," *Proceedings, Association of Asphalt Paving Technologists*, Vol. 40, pp. 227-246, Oklahoma City, Oklahoma, February.
- Metcalf, J. (1996), *Application of Full-Scale Accelerated Pavement Testing*, National Cooperative Highway Program, Synthesis of Highway Practice 235.
- Miner, M.A. (1945), "Cumulative Damage in Fatigue," *Transactions, American Society of Mechanical Engineers*, Vol. 67, pp. A159-A164.
- Monismith, C.L. et al. (1961), "Asphalt Mixture Behavior in Repeated Flexure," *Proceedings, Association of Asphalt Paving Technologists*, Vol. 30.
- Monismith, C.L., and J.A. Deacon (1969), "Fatigue of Asphalt Paving Mixtures," *Journal of Transportation Engineering, ASCE*, 95(2), pp. 317-346.
- Monismith, C.L., J.A. Epps, D.A. Kasianchuk, and D.B. McLean (1971), *Asphalt Mixture Behavior in Repeated Flexure*, Reprot TE 70-5, University of California, Berkeley, p.303.
- Monismith, C.L., N. Ogawa, C.R. Freeme (1975), "Permanent Deformation Characteristics of Subgrade Soils due to Repeated Loading," *Transportation Research Record 537*.
- Monismith, C.L., J.A. Epps, and F.N. Finn (1985), "Improved Asphalt Mix Design", *Proceedings, Association of Asphalt Paving Technologists*, Vol. 54, February.
- Monismith, C.L., F.N. Finn, G. Ahlborn, and N. Markevich (1987), "A General Analytically Based Approach to the Design of Asphalt Concrete Pavements," *Proceedings, 6th*

- International Conference on the Structural Design of Asphalt Pavements*, University of Michigan, pp. 344-365.
- Monismith, C.L. (1992), "Analytically Based Asphalt Pavement Design and Rehabilitation: Theory to Practice, 1962-1992," *Transportation Research Record 1354*, Washington, D.C.
- Oh, B.H. (1991), "Cumulative Damage Theory of Concrete Under Variable-Amplitude Fatigue Loadings," *ACI Materials Journal*, Vol.88, No. 1, pp. 41-48.
- Palmgren, A.G. (1924), "Die Lebensdauer von Kugellagern," *VDI-Zeitschrift des Vereines Deutscher Ingenieure*, Vol. 68, No. 14.
- Paris, P.C. and F.J. Erdogan (1964), "A Critical Analysis of Crack Propagation Laws," *Journal of Basic Engineering, Transactions of the American Society for Testing and Materials*, Special Technical Publication No. 381.
- PARIS (1999), "PARIS: Performance Analysis of Road Infrastructure," Luxembourg: Office for Official Publications of the European Communities.
- Pell, P.S. (1963), "Fatigue Characteristics of Bitumen and Bituminous Mixes," *Proceedings, International Conference on the Structural Design of Asphalt Pavements*, University of Michigan, pp. 310-323.
- Pell, P.S. (1973), "Characterization of Fatigue Behavior," Special Report 140: Structural Design of Asphalt Concrete Pavement Systems to Pavement Fatigue Cracking, HRB, National Research Council, Washington, D.C.
- Pell, P.S. (1987), "Keynote Lecture—Pavement Materials," *Sixth International Conference on the Structural Design of Asphalt Pavements*, Vol. 2, pp. 36-70.
- Peutz, M.G.F., H.P.M. van Kempen and A. Jones (1968), "Layered System under Normal Surface Loads," *Highway Research Record 228*.
- Powell, W.D., et al. (1984), *The Structural Design of Bituminous Pavements*, TRRL Laboratory Report 1132, Transportation and Road Research Laboratory, U.K.
- Pronk, A.C., and P.C. Hopman (1990), "Energy Dissipation: the leading factor of fatigue," *Proceedings, United States Strategic Highway Research Program-Sharing the Benefits*, October 29-31, London.
- Pronk, A.C., R.L. Krans, and F. van Gogh (1996), *Temperature Increase in an Asphalt Beam during Fatigue-Theory and Practice*, CROW Wegbouwkundige Werkdagen.

- Raithby, K.D. and A.B. Sterling (1970), "The Effect of Rest Periods on the Fatigue Performance of a Hot-Rolled Asphalt under Reverse Axial Loading," *Proceedings, Association of Asphalt Paving Technologists*, Vol. 39, 134.
- Raithby, K.D. and A.B. Sterling (1972), "Laboratory Fatigue Tests on Rolled Asphalt and their Relation to Traffic Loading," *Roads and Road Construction*, Vol. 50, Nos. 596-7, August/September.
- Saal, R.N.J. and P.S. Pell (1960), "Fatigue of Bituminous Road Mixes," *Kolloid-Zeitschrift*, 171. Bd., Heft 1, Seite 61-71.
- Salam, Y.M. and C.L. Monismith (1971), "Fracture Characteristics of Asphalt Concrete," *Proceedings, Association of Asphalt Paving Technologists*, Vol. 41, pp.215-256, Cleveland, Ohio, February.
- Seber, G.A.F. (1977), *Linear Regression Analysis*, John Wiley & Sons.
- Sebaaly, P., N. Tabatabaee, R. Bonaquist, and D. Anderson (1989), "Evaluating Structural Damage of Flexible Pavement Using Cracking and FWD Data," Paper presented at the 68th Annual Meeting of the Transportation Research Board, Washington, D.C.
- Shell (1978), *Shell Pavement Design Manual*, Shell International Petroleum Company, Limited, London.
- Shell (1985), *Addendum to the Shell Pavement Design Manual*, Shell International Petroleum Company, Limited, London.
- Shin, C. (1999), Unpublished Data, University of California, Berkeley.
- Sousa, J.B., J. Lysmer, S.S. Chen, and C.L. Monismith (1988), "Dynamic Loads: Effects on the Performance of Asphalt Concrete Pavements," *Transportation Research Record 1207*, TRB, National Research Council, Washington, D.C., pp. 145-168.
- Spector, P. (1996), *Lecture Notes for Statistics 243: Introduction to Statistical Computing*, Fall Semester, University of California, Berkeley.
- Stone, Charles J. (1996), *A Course in Probability and Statistics*, Duxbury Press.
- Tayebali, A.A. (1992), *Re-calibration of surrogate fatigue model using all applicable A-003A fatigue data*, Technical memorandum prepared for SHRP Project A-003A. Institute of Transportation Studies, University of California, Berkeley.
- Tayebali, A.A., J.A. Deacon, J.S. Coplantz, J.T. Harvey, and C.L. Monismith (1994), *Fatigue Response of Asphalt-Aggregate Mixes*, SHRP-A-404, Strategic Highway Research Program, National Research Council, Washington, D.C.

- Taylor, R.L. (1998), *FEAP—A Finite Element Analysis Program (Version 7.1 User Manual)*, Department of Civil and Environmental Engineering, University of California, Berkeley.
- Thompson, M.R. (1987), “ILLI-PAVE Based Full-Depth Asphalt Concrete Pavement Design Procedure,” *Proceedings, Sixth International Conference on Structural Design of Asphalt Pavements*, Vol. 1, pp.13-22.
- Ullidtz, P. (1998), *Modelling Flexible Pavement Response and Performance*, Polyteknisk Forlag.
- Ullidtz, P. (1987), *Pavement Analysis*, Elsevier Science Publishing Co., Inc., Amsterdam, The Netherlands.
- Ullidtz, P. (1999), *MDD Data Analysis for 500RF*, draft.
- van der Poel, C. (1954), “A General System Describing the Visco-elastic Properties of Bitumens and its relation to Routine Test Data,” *Journal of Applied Chemistry*, May, pp. 221-236.
- van Dijk, W., et al. (1972), “The Fatigue of Bitumen and Bituminous Mixes,” *Proceedings, 3rd International Conference on Structural Design of Asphalt Pavements*, London, Vol. 1, pp. 38-74.
- van Dijk, W. (1975), “Practical Fatigue Characterization of Bituminous Mixes,” *Proceedings, Association of Asphalt Paving Technologists*, Vol. 44, pp. 38-74.
- van Dijk, W. and W. Visser (1977), “The Energy Approach to Failure for Pavement Design,” *Proceedings, Association of Asphalt Paving Technologists*, San Antonio, Tx, February.
- Verstraeten, J., V. Ververka, and L. Francken (1982), “Rational and Practical Designs of Asphalt Pavements to Avoid Cracking and Rutting,” *Proceedings, Fifth International Conference on the Structural Design of Asphalt Pavements*.
- Wang, M.C., and Larson, T.D., (1978). “Use of road rater deflections in pavement evaluation.” *Transportation Research Record 666*, Transportation Research Board, Washington, D.C., 129-150.
- WASHO (1954), *Special Report 18: The WASHO Road Test, Part 1: Design, Construction, and Testing Procedures*, HRB, National Research Council, Washington, D.C.
- WASHO (1955), *Special Report 22: The WASHO Road Test, Part 2: Test Data, Analysis, Findings*, HRB, National Research Council, Washington, D.C.
- Witczak, M.W., H. Von Quintas, and C.W. Schwartz (1997), “Superpave Support and Performance Models Management: Evaluation of the SHRP Performance Models System,” *Proceedings, Eighth International Conference on Asphalt Pavements*, Volume 3, August.

- Wardle, L.J. (1977), *Program Circly: A Computer Program for the Analysis of Multiple Complex Circular Loads on Layered Anisotropic Media*, User's Manual, Division of Applied Geomechanics, Commonwealth Scientific and Industrial Research Organization, Australia.
- Wilson, E.L. (1965), *A Digital Computer Program for the Finite Element Analysis of Solids with Non-Linear Material Properties*, Department of Civil Engineering, University of California, Berkeley.
- Weibull, W. (1939a), "A Statistical Theory of the Strength of Materials," *Ing. Vetenskaps Akad. Handl. No. 151*.
- Weibull, W. (1939b), "The Phenomenon of Rupture in Solids," *Ing. Vetenskaps Akad. Handl. No. 153*.
- WesTrack Team (1996), *Accelerated Field Test of Performance-Related Specifications for Hot-Mix Asphalt Construction*, WesTrack Team, Task G Interim Report, Final Draft, March.

APPENDIX A:

TABLES

Table A.4.1 Fatigue Rest Results and Weibull Regression Fits at 20°C

Specimen Name	Grad. Type	AC (%)	AV (%)	Test Strain	Rs4s50	M200 (%)	SA (m ² /kg)	VMA (%)	VFA (%)	nf	Stif (MPa)	Ln(-ln(SR))=aa+bb*ln(n)			Ln(-ln(SR))=cc+dd*ln(ln(n))		
												aa	bb	R ²	cc	dd	R ²
WT01-FB	Fine	5.75	8.95	0.000197	3.03	4.1	5.06	13.7	71.6	1693277	3085	-6.2139	0.4118	0.98	-10.872	3.8838	0.98
WT01-AB	Fine	5.75	8.78	0.000198	3.03	4.1	5.06	13.7	71.6	1361835	3259	-6.2423	0.4280	0.95	-11.083	4.0239	0.98
WT01-BB	Fine	5.75	8.97	0.000398	3.03	4.1	5.06	13.7	71.6	82500	2892	-5.8554	0.4944	0.95	-10.143	4.0374	0.99
WT01-CB	Fine	5.75	8.76	0.000402	3.03	4.1	5.06	13.7	71.6	63379	3290	-6.2648	0.5410	0.97	-10.774	4.3296	0.99
WT01-EB	Fine	5.75	8.58	0.000401	3.03	4.1	5.06	13.7	71.6	56018	3444	-6.0521	0.5257	0.99	-10.254	4.1179	0.99
WT03-FB	Fine	5.13	11.97	0.000198	3.23	4.2	5.35	13.7	60.1	649225	3052	-5.9690	0.4398	0.96	-10.353	3.8707	0.98
WT03-CB	Fine	5.13	11.44	0.000198	3.23	4.2	5.35	13.7	60.1	531729	3745	-5.9644	0.4340	0.95	-10.868	4.0776	0.99
WT03-EB	Fine	5.13	12.46	0.000197	3.23	4.2	5.35	13.7	60.1	219257	3640	-7.0071	0.5594	0.96	-12.123	4.6931	0.99
WT03-DB	Fine	5.13	12.44	0.000400	3.23	4.2	5.35	13.7	60.1	25395	2931	-6.0258	0.5640	0.97	-10.395	4.3431	0.98
WT03-BB	Fine	5.13	11.92	0.000398	3.23	4.2	5.35	13.7	60.1	19395	3309	-6.6511	0.6493	0.99	-11.586	4.9582	0.99
WT03-AB	Fine	5.13	11.84	0.000398	3.23	4.2	5.35	13.7	60.1	12507	3182	-6.6873	0.6691	0.98	-10.687	4.5266	0.98
WT15-AB	Fine	5.56	7.39	0.000148	3.08	4.7	5.71	13.8	67.3	10745213	4081	-5.7227	0.3463	0.96	-9.7564	3.3177	0.98
WT15-DB	Fine	5.56	7.60	0.000196	3.08	4.7	5.71	13.8	67.3	1329105	4117	-5.8519	0.3958	0.97	-10.435	3.7742	0.98
WT15-EB	Fine	5.56	7.68	0.000198	3.08	4.7	5.71	13.8	67.3	1180799	4648	-6.6191	0.4655	0.93	-11.850	4.3731	0.99
WT15-BB	Fine	5.56	7.40	0.000298	3.08	4.7	5.71	13.8	67.3	257485	4068	-5.5250	0.4214	0.99	-10.058	3.8306	0.99
WT15-FB	Fine	5.56	7.61	0.000400	3.08	4.7	5.71	13.8	67.3	65556	3772	-6.3715	0.5496	0.97	-10.685	4.2606	0.99
WT15-CB	Fine	5.56	7.53	0.000452	3.08	4.7	5.71	13.8	67.3	53330	3851	-5.8790	0.5104	0.99	-10.114	4.0779	0.97
WT04-AT	Fine	5.24	6.50	0.000199	3.27	4.4	5.63	14.3	61.1	1628332	5600	-6.5560	0.4273	0.95	-11.384	4.0245	0.99
WT04-DB	Fine	5.62	5.74	0.000185	3.22	4.3	5.54	13.8	68.9	1100000	5728	-5.9855	0.4100	0.95	-10.696	3.8870	0.99
WT04-AB	Fine	5.62	5.82	0.000184	3.22	4.3	5.54	13.8	68.9	783333	5865	-6.6463	0.4761	0.95	-11.802	4.3754	0.97
WT04-EB	Fine	5.62	5.76	0.000371	3.22	4.3	5.54	13.8	68.9	20337	5144	-7.4405	0.7298	0.95	-12.188	5.1417	0.97
WT04-CB	Fine	5.62	6.71	0.000369	3.22	4.3	5.54	13.8	68.9	20000	4710	-7.1249	0.6971	0.94	-11.648	4.9038	0.98
WT09-BT	Fine plus	6.07	3.10	0.000199	2.96	5.2	6.03	12.3	100	5201449	6356	-5.1084	0.2986	0.94	-9.0580	3.0581	0.93
WT09-CT	Fine plus	6.07	3.50	0.000198	2.96	5.2	6.03	12.3	100	3547924	6269	-5.2968	0.3021	0.97	-9.0078	2.9748	0.98
WT09-FB	Fine plus	5.8	2.12	0.000199	3.04	6.2	6.87	12.4	92.1	3402782	6135	-5.8249	0.3893	0.94	-10.366	3.7352	0.99
WT09-BB	Fine plus	5.8	1.90	0.000401	3.04	6.2	6.87	12.4	92.1	146187	5789	-6.0836	0.4921	0.95	-10.709	4.1934	0.99
WT09-CB	Fine plus	5.8	2.41	0.000398	3.04	6.2	6.87	12.4	92.1	141553	6380	-6.2845	0.5108	0.97	-10.845	4.2375	0.99
WT09-EB	Fine plus	5.8	1.95	0.000401	3.04	6.2	6.87	12.4	92.1	120557	6640	-6.1797	0.5084	0.97	-10.772	4.2443	0.99
WT19-FB	Fine plus	5.48	6.99	0.000197	3.01	5.7	6.53	12.1	83.1	2312885	4144	-5.4445	0.3353	0.97	-9.2134	3.1565	0.98
WT19-CB	Fine plus	5.48	6.75	0.000197	3.01	5.7	6.53	12.1	83.1	2296949	4410	-5.6618	0.3666	0.98	-10.141	3.6036	0.99
WT19-AT	Fine plus	5.41	7.10	0.000200	2.87	5.8	6.53	11.7	95.1	2242245	4902	-6.0345	0.3806	0.98	-10.243	3.5547	0.97
WT19-EB	Fine plus	5.48	7.52	0.000402	3.01	5.7	6.53	12.1	83.1	89074	3987	-6.2237	0.5241	0.96	-10.773	4.2818	0.99
WT19-AB	Fine plus	5.48	7.23	0.000404	3.01	5.7	6.53	12.1	83.1	63069	4416	-6.3094	0.5463	0.96	-10.751	4.3158	0.98
WT19-BT	Fine plus	5.41	7.60	0.000400	2.87	5.8	6.53	11.7	95.1	34103	4308	-6.5298	0.5958	0.98	-11.201	4.6190	0.98
WT21-ET	Fine plus	6.25	4.10	0.000199	2.94	5.4	6.41	12.1	96.7	4869664	5776	-6.4113	0.3862	0.97	-11.172	3.8164	0.97

Specimen Name	Grad. Type	AC (%)	AV (%)	Test Strain	Rs4s50	M200 (%)	SA (m ² /kg)	VMA (%)	VFA (%)	nf	Stif (MPa)	Ln(-ln(SR))=aa+bb*ln(n)			Ln(-ln(SR))=cc+dd*ln(ln(n))		
												aa	bb	R ²	cc	dd	R ²
WT21-EB	Fine plus	5.84	3.05	0.000199	2.75	5.3	6.09	11.9	92.9	2958772	5932	-5.7926	0.3790	0.98	-10.334	3.6769	0.99
WT21-FT	Fine plus	6.25	3.10	0.000200	2.94	5.4	6.41	12.1	96.7	2257739	6599	-5.5913	0.3294	0.98	-9.3276	3.1013	0.97
WT21-AB	Fine plus	5.84	3.33	0.000398	2.75	5.3	6.09	11.9	92.9	288812	5389	-5.3169	0.4160	0.94	-9.2523	3.5563	0.98
WT21-BB	Fine plus	5.84	2.86	0.000398	2.75	5.3	6.09	11.9	92.9	170432	5510	-6.1861	0.5069	0.93	-10.707	4.2091	0.97
WT21-CB	Fine plus	5.84	2.85	0.000399	2.75	5.3	6.09	11.9	92.9	149443	5468	-6.1406	0.4942	0.95	-10.731	4.1845	0.99
WT05-EB	Coarse	5.61	9.15	0.000197	3.83	5.7	5.09	13.5	69.1	2074970	4534	-4.8522	0.3146	0.90	-8.4561	2.9855	0.96
WT05-AT	Coarse	5.67	8.89	0.000186	3.43	6.5	5.55	12.1	77.6	1730000	6344	-6.3708	0.4407	0.85	-11.848	4.3762	0.93
WT05-DT	Coarse	5.67	8.80	0.000185	3.43	6.5	5.55	12.1	77.6	1560000	5403	-6.1388	0.3800	0.93	-10.210	3.4807	0.96
WT05-AB	Coarse	5.61	9.54	0.00197	3.83	5.7	5.09	13.5	69.1	1383439	4159	-5.5791	0.3652	0.99	-9.5298	3.3693	0.97
WT05-CB	Coarse	5.61	8.89	0.000398	3.83	5.7	5.09	13.5	69.1	99996	4120	-5.8360	0.4882	0.97	-9.8900	3.8978	0.99
WT05-FB	Coarse	5.61	9.51	0.000398	3.83	5.7	5.09	13.5	69.1	69060	4222	-5.5119	0.4678	0.96	-9.5622	3.8171	0.99
WT05-BB	Coarse	5.61	9.51	0.000405	3.83	5.7	5.09	13.5	69.1	59514	3505	-6.0545	0.5192	0.98	-9.9293	3.9230	0.99
WT06-ET	Coarse	5.73	14.10	0.000185	3.33	6.3	5.47	12.2	73.5	9464858	3566	-5.8835	0.3517	0.97	-9.9118	3.3411	0.98
WT06-CT	Coarse	5.73	14.60	0.000185	3.33	6.3	5.47	12.2	73.5	3028267	3674	-5.8961	0.3725	0.95	-10.057	3.4916	0.98
WT06-BT	Coarse	5.73	14.70	0.000185	3.33	6.3	5.47	12.2	73.5	2750000	3890	-6.0401	0.3780	0.97	-10.434	3.6279	0.97
WT06-CB	Coarse	5.89	13.84	0.000197	3.89	5.4	4.95	14.1	65.6	1668256	3960	-5.9014	0.4009	0.98	-10.095	3.6270	0.98
WT06-DB	Coarse	5.89	13.37	0.000402	3.89	5.4	4.95	14.1	65.6	81026	3159	-6.2894	0.5330	0.97	-10.761	4.2787	0.99
WT06-BB	Coarse	5.89	12.82	0.000400	3.89	5.4	4.95	14.1	65.6	80888	3468	-6.1050	0.5151	0.98	-10.382	4.1147	0.99
WT07-FT	Coarse	6.28	7.90	0.000200	3.46	6.4	5.53	13.0	86.5	6175457	4776	-5.8534	0.3525	0.99	-9.8400	3.3339	0.98
WT07-DB	Coarse	6.38	7.98	0.000187	3.73	5.4	4.91	13.6	77.9	3828442	4708	-6.4941	0.3682	0.94	-10.283	3.3221	0.85
WT07-CB	Coarse	6.38	8.36	0.000184	3.73	5.4	4.91	13.6	77.9	2474999	5268	-7.0729	0.4473	0.97	-12.144	4.2324	0.97
WT07-EB	Coarse	6.38	8.26	0.000399	3.73	5.4	4.91	13.6	77.9	101026	4859	-6.4485	0.5417	0.97	-11.119	4.4111	0.99
WT07-BB	Coarse	6.38	8.18	0.000404	3.73	5.4	4.91	13.6	77.9	99364	4064	-7.0992	0.6053	0.93	-12.296	4.9138	0.98
WT07-AB	Coarse	6.38	7.88	0.000400	3.73	5.4	4.91	13.6	77.9	63293	4821	-6.7889	0.5890	0.98	-11.685	4.7077	0.99
WT26-BB	Coarse	5.37	13.01	0.000186	3.87	5.3	4.86	13.9	66.6	2452992	4301	-6.5836	0.4107	0.94	-11.119	3.8254	0.97
WT26-AB	Coarse	5.37	12.40	0.000181	3.87	5.3	4.86	13.9	66.6	1381976	4577	-5.7625	0.3629	0.98	-9.6183	3.3088	0.97
WT26-FB	Coarse	5.37	13.33	0.000185	3.87	5.3	4.86	13.9	66.6	1050000	4323	-6.5686	0.4470	0.96	-11.277	4.0588	0.98
WT26-DB	Coarse	5.37	12.60	0.000364	3.87	5.3	4.86	13.9	66.6	52500	4231	-7.2200	0.6459	0.94	-12.163	4.9390	0.97
WT26-CB	Coarse	5.37	13.08	0.000368	3.87	5.3	4.86	13.9	66.6	48999	4570	-7.2858	0.6556	0.97	-11.985	4.8504	0.99
WT26-EB	Coarse	5.37	13.04	0.000365	3.87	5.3	4.86	13.9	66.6	26071	4385	-7.6598	0.7249	0.97	-12.426	5.1367	0.99
WT08-EB	Coarse	5.54	7.20	0.000185	3.90	5.7	5.08	14.0	56.6	6603786	6538	-6.0292	0.3403	0.97	-9.9209	3.2369	0.97
WT08-BB	Coarse	5.54	8.80	0.000185	3.90	5.7	5.08	14.0	56.6	2020000	6268	-6.2282	0.3691	0.96	-10.575	3.5447	0.99
WT08-FB	Coarse	5.54	9.40	0.000186	3.90	5.7	5.08	14.0	56.6	1774999	5538	-6.9220	0.4478	0.97	-12.444	4.4096	0.98
WT08-DB	Coarse	5.54	8.60	0.000363	3.90	5.7	5.08	14.0	56.6	126786	6197	-6.2584	0.495	0.96	-10.392	3.9630	0.99
WT08-AB	Coarse	5.54	7.30	0.000363	3.90	5.7	5.08	14.0	56.6	94166	7188	-6.8917	0.5765	0.95	-11.734	4.6286	0.99
WT08-CB	Coarse	5.54	9.30	0.000376	3.90	5.7	5.08	14.0	56.6	29582	6013	-7.4480	0.6732	0.99	-11.854	4.7645	0.98

Specimen Name	Grad. Type	AC (%)	AV (%)	Test Strain	Rs4s50	M200 (%)	SA (m ² /kg)	VMA (%)	VFA (%)	nf	Stif (MPa)	Ln(-Ln(SR))=aa+bb*ln(n)			Ln(-Ln(SR))=cc+dd*ln(ln(n))		
												aa	bb	R ²	cc	dd	R ²
WT11-AB	Fine plus	5.16	6.90	0.000200	2.93	6.5	6.87	11.9	85.5	1510343	5460	-6.0417	0.3843	0.96	-10.256	3.5587	0.99
WT11-CB	Fine plus	5.16	6.50	0.000199	2.93	6.5	6.87	11.9	85.5	728637	5935	-6.2158	0.417	0.97	-10.319	3.6491	0.97
WT11-EB	Fine plus	5.16	7.30	0.000198	2.93	6.5	6.87	11.9	85.5	456612	5381	-5.9261	0.3658	0.92	-9.4368	3.1489	0.90
WT11-BB	Fine plus	5.16	6.70	0.000400	2.93	6.5	6.87	11.9	85.5	71561	5560	-6.2425	0.5300	0.97	-10.569	4.1973	0.98
WT11-DB	Fine plus	5.16	7.20	0.000399	2.93	6.5	6.87	11.9	85.5	33086	5513	-6.1486	0.5428	0.99	-10.429	4.1785	0.99
WT11-FB	Fine plus	5.16	6.60	0.000400	2.93	6.5	6.87	11.9	85.5	31497	5644	-7.3409	0.6651	0.96	-12.152	4.9211	0.98
WT23-FB	Coarse	5.84	6.99	0.000199	3.89	5.6	5.07	14.1	67.8	3495733	6673	-6.0924	0.3555	0.95	-10.100	3.3569	0.94
WT23-DB	Coarse	5.84	6.15	0.000199	3.89	5.6	5.07	14.1	67.8	2939924	6873	-6.4938	0.3902	0.96	-10.833	3.6563	0.94
WT23-CB	Coarse	5.84	7.12	0.000199	3.89	5.6	5.07	14.1	67.8	1804173	6703	-6.9322	0.4401	0.90	-11.808	4.1046	0.93
WT23-EB	Coarse	5.84	6.17	0.000397	3.89	5.6	5.07	14.1	67.8	143012	6543	-6.0225	0.4747	0.99	-10.582	4.0646	0.99
WT23-AB	Coarse	5.84	6.63	0.000398	3.89	5.6	5.07	14.1	67.8	121915	6792	-6.2432	0.5027	0.96	-10.444	4.0262	0.99
WT23-BB	Coarse	5.84	6.70	0.000398	3.89	5.6	5.07	14.1	67.8	105560	6351	-5.7311	0.4517	0.99	-10.238	3.9360	0.99
WT24-BB	Coarse	5.78	9.10	0.000199	3.79	5.5	5.01	14.0	63.7	5312952	5570	-6.6757	0.4003	0.96	-11.462	3.9032	0.97
WT24-CB	Coarse	5.78	8.86	0.000199	3.79	5.5	5.01	14.0	63.7	3295240	4798	-6.8345	0.3857	0.85	-10.879	3.5172	0.77
WT24-FB	Coarse	5.78	8.94	0.000203	3.79	5.5	5.01	14.0	63.7	2807182	4791	-6.0031	0.3917	0.95	-11.004	3.9472	0.99
WT24-EB	Coarse	5.78	9.54	0.000400	3.79	5.5	5.01	14.0	63.7	83453	4928	-6.4823	0.5423	0.96	-10.956	4.3164	0.97
WT24-DB	Coarse	5.78	9.14	0.000399	3.79	5.5	5.01	14.0	63.7	62036	5112	-6.2714	0.5130	0.98	-9.8470	3.7433	0.99
WT24-AB	Coarse	5.78	9.90	0.000399	3.79	5.5	5.01	14.0	63.7	60607	4673	-5.3475	0.4594	0.94	-8.8783	3.5200	0.98
WT25-FB	Coarse	6.24	4.48	0.000200	3.73	5.6	5.08	13.3	81.3	5474962	5298	-5.6301	0.3579	0.96	-9.9292	3.4956	0.98
WT25-EB	Coarse	6.24	4.05	0.000200	3.73	5.6	5.08	13.3	81.3	5078448	5424	-5.5657	0.3610	0.95	-9.7487	3.4542	0.98
WT25-BB	Coarse	6.24	4.97	0.000199	3.73	5.6	5.08	13.3	81.3	5002759	6091	-6.1894	0.3572	0.94	-10.319	3.4177	0.95
WT25-DB	Coarse	6.24	5.00	0.000397	3.73	5.6	5.08	13.3	81.3	172232	5125	-5.6516	0.4557	0.97	-9.4847	3.6630	0.99
WT25-AB	Coarse	6.24	4.46	0.000398	3.73	5.6	5.08	13.3	81.3	154517	6085	-5.7400	0.4435	0.99	-10.170	3.8709	0.99
WT18-BB	Fine	6.26	3.72	0.000199	3.21	4.5	5.60	13.3	77.0	2845417	6530	-6.3639	0.3729	0.95	-10.701	3.5740	0.95
WT18-EB	Fine	6.26	4.28	0.000202	3.21	4.5	5.60	13.3	77.0	2739498	5756	-5.3520	0.3461	0.96	-9.5600	3.4026	0.99
WT18-DB	Fine	6.26	4.11	0.000202	3.21	4.5	5.60	13.3	77.0	2315129	5977	-5.9017	0.3889	0.97	-10.670	3.8441	0.98
WT18-AB	Fine	6.26	3.96	0.000404	3.21	4.5	5.60	13.3	77.0	189168	5558	-6.2117	0.5048	0.96	-10.793	4.2239	0.99
WT18-FB	Fine	6.26	4.12	0.000400	3.21	4.5	5.60	13.3	77.0	133412	5760	-6.2414	0.5110	0.96	-10.741	4.2086	0.99
WT18-CB	Fine	6.26	4.05	0.000397	3.21	4.5	5.60	13.3	77.0	115835	5766	-5.6314	0.4561	0.99	-9.9007	3.8696	0.99
WT13-CB	Fine plus	5.76	6.79	0.000199	3.07	5.5	6.10	12.0	87.1	2212757	4682	-6.4808	0.4334	0.96	-11.991	4.3541	0.99
WT13-BB	Fine plus	5.76	6.25	0.000198	3.07	5.5	6.10	12.0	87.1	1771490	4264	-6.8038	0.4616	0.97	-12.076	4.3840	0.98
WT13-AB	Fine plus	5.76	6.53	0.000203	3.07	5.5	6.10	12.0	87.1	974825	4790	-6.9651	0.5010	0.97	-11.754	4.3188	0.96
WT13-FB	Fine plus	5.76	6.23	0.000382	3.07	5.5	6.10	12.0	87.1	144416	4044	-6.0590	0.4922	0.93	-10.695	4.1987	0.97
WT13-EB	Fine plus	5.76	6.55	0.000393	3.07	5.5	6.10	12.0	87.1	112069	4079	-6.3889	0.5325	0.90	-11.137	4.4102	0.94
WT13-DB	Fine plus	5.76	6.78	0.000396	3.07	5.5	6.10	12.0	87.1	99999	4426	-6.2766	0.5274	0.96	-11.037	4.3911	0.99
WT14-DB	Fine	6.62	7.04	0.000200	3.19	4.5	5.65	13.2	84.3	2746741	4197	-5.7322	0.3807	0.94	-10.260	3.6873	0.98

Specimen Name	Grad. Type	AC (%)	AV (%)	Test Strain	Rs4s50	M200 (%)	SA (m ² /kg)	VMA (%)	VFA (%)	nf	Stif (MPa)	Ln(-ln(SR))=aa+bb*ln(n)			Ln(-ln(SR))=cc+dd*ln(ln(n))		
												aa	bb	R ²	cc	dd	R ²
WT14-CB	Fine	6.62	6.55	0.000198	3.19	4.5	5.65	13.2	84.3	2205142	4419	-5.6386	0.3735	0.97	-10.494	3.7888	0.99
WT14-BB	Fine	6.62	6.34	0.000198	3.19	4.5	5.65	13.2	84.3	1729116	4494	-6.7913	0.4737	0.93	-12.055	4.4171	0.98
WT14-EB	Fine	6.62	6.91	0.000400	3.19	4.5	5.65	13.2	84.3	107267	3898	-6.1890	0.5087	0.99	-11.209	4.4090	0.99
WT14-FB	Fine	6.62	6.64	0.000404	3.19	4.5	5.65	13.2	84.3	89011	4150	-6.3320	0.5317	0.97	-11.274	4.4882	0.99
WT02-KB	Fine	4.76	8.86	0.000200	3.21	4.2	5.26	13.7	64.9	1984922	5866	-5.6834	0.3758	0.97	-9.9547	3.5591	0.99
WT02-NB	Fine	4.76	9.80	0.000201	3.21	4.2	5.26	13.7	64.9	1814493	5979	-5.9132	0.4105	0.94	-11.108	4.1190	0.98
WT02-LB	Fine	4.76	10.42	0.000198	3.21	4.2	5.26	13.7	64.9	1066325	6071	-5.7804	0.3862	0.94	-9.9113	3.5354	0.96
WT02-GB	Fine	4.76	9.31	0.000399	3.21	4.2	5.26	13.7	64.9	167149	4986	-6.4012	0.5962	0.96	-9.8265	3.9537	0.98
WT02-IB	Fine	4.76	10.27	0.000401	3.21	4.2	5.26	13.7	64.9	58979	5246	-5.9938	0.5194	0.97	-10.273	4.1307	0.99
WT02-HB	Fine	4.76	11.41	0.000397	3.21	4.2	5.26	13.7	64.9	11370	5012	-7.0854	0.7304	0.96	-11.421	4.9218	0.99
WT16-FB	Fine	4.79	11.55	0.000199	3.20	4.4	5.51	13.9	52.2	1079316	3773	-6.0937	0.4363	0.92	-10.837	4.0169	0.96
WT16-AB	Fine	4.79	11.20	0.000200	3.20	4.4	5.51	13.9	52.2	694716	3505	-6.0730	0.4409	0.94	-10.809	4.0176	0.98
WT16-BB	Fine	4.79	11.54	0.000198	3.20	4.4	5.51	13.9	52.2	504443	3632	-6.1100	0.4505	0.92	-10.797	4.0583	0.96
WT16-DB	Fine	4.79	11.63	0.000401	3.20	4.4	5.51	13.9	52.2	34185	3129	-5.8435	0.5314	0.97	-10.237	4.2343	0.99
WT16-EB	Fine	4.79	11.38	0.000401	3.20	4.4	5.51	13.9	52.2	32552	3431	-6.4303	0.5971	0.95	-10.754	4.4386	0.98
WT12-CB	Fine plus	5.27	5.47	0.000199	3.09	5.4	6.27	12.1	80.2	1954591	6603	-5.7314	0.3811	0.94	-10.222	3.6721	0.97
WT12-BB	Fine plus	5.27	5.81	0.000197	3.09	5.4	6.27	12.1	80.2	1950901	6452	-5.5451	0.3724	0.93	-9.8873	3.5721	0.98
WT12-FB	Fine plus	5.27	4.86	0.000201	3.09	5.4	6.27	12.1	80.2	749999	6472	-6.1483	0.4360	0.98	-10.874	4.0053	0.99
WT12-DB	Fine plus	5.27	5.09	0.000399	3.09	5.4	6.27	12.1	80.2	57875	6378	-6.2954	0.5458	0.97	-11.029	4.4626	0.98
WT12-AB	Fine plus	5.27	5.32	0.000400	3.09	5.4	6.27	12.1	80.2	44854	5922	-6.0914	0.5348	0.98	-9.8359	3.9124	0.99
WT12-EB	Fine plus	5.27	5.62	0.000401	3.09	5.4	6.27	12.1	80.2	37368	6068	-6.5395	0.5952	0.98	-11.003	4.5077	0.99
WT22-BB	Fine plus	4.52	8.12	0.000199	3.12	4.9	6.04	12.9	65.6	1261168	5421	-5.5765	0.3792	0.96	-9.6052	3.4567	0.99
WT22-CB	Fine plus	4.52	8.38	0.000199	3.12	4.9	6.04	12.9	65.6	1150030	5337	-5.5315	0.3726	0.97	-9.4702	3.3878	0.99
WT22-EB	Fine plus	4.52	7.93	0.000199	3.12	4.9	6.04	12.9	65.6	649999	5480	-6.0637	0.4405	0.92	-10.358	3.8266	0.97
WT22-FB	Fine plus	4.52	8.25	0.000400	3.12	4.9	6.04	12.9	65.6	34778	4750	-6.4649	0.5803	0.99	-10.372	4.1639	0.99
WT22-AB	Fine plus	4.52	8.04	0.000400	3.12	4.9	6.04	12.9	65.6	27130	5148	-6.4239	0.5973	0.99	-10.391	4.2555	0.99
WT22-DB	Fine plus	4.52	8.11	0.000399	3.12	4.9	6.04	12.9	65.6	23273	5099	-6.5560	0.6175	0.96	-10.606	4.3708	0.98
WT20-FB	Fine plus	5.13	8.11	0.000199	2.99	5.1	5.95	11.7	80.6	3312789	4397	-5.6640	0.3589	0.96	-9.9305	3.4842	0.99
WT20-BB	Fine plus	5.13	9.41	0.000498	2.99	5.1	5.95	11.7	80.6	2356508	4020	-7.1011	0.5004	0.91	-12.653	4.6652	0.97
WT20-AB	Fine plus	5.13	9.01	0.000201	2.99	5.1	5.95	11.7	80.6	1340813	3872	-6.5149	0.4454	0.94	-11.941	4.3567	0.97
WT20-CB	Fine plus	5.13	8.76	0.000403	2.99	5.1	5.95	11.7	80.6	57544	3883	-6.3448	0.5577	0.97	-10.772	4.3494	0.99
WT20-DB	Fine plus	5.13	8.64	0.000397	2.99	5.1	5.95	11.7	80.6	37528	3970	-6.9944	0.6384	0.97	-11.629	4.7548	0.99
WT20-EB	Fine plus	5.13	9.00	0.000400	2.99	5.1	5.95	11.7	80.6	35055	3627	-6.0686	0.5328	0.99	-10.345	4.1407	0.98
WT10-KB	Fine plus	4.33	12.44	0.000199	2.95	5.2	6.01	12.6	62.9	479152	4638	-5.9528	0.4368	0.95	-10.945	4.1097	0.98
WT10-JB	Fine plus	4.33	13.68	0.000199	2.95	5.2	6.01	12.6	62.9	160543	4474	-5.9442	0.4740	0.98	-9.9752	3.8344	0.99
WT10-GB	Fine plus	4.33	12.95	0.000201	2.95	5.2	6.01	12.6	62.9	134182	4226	-5.4518	0.4326	0.99	-9.4703	3.6692	0.99
WT10-HB	Fine plus	4.33	11.51	0.000400	2.95	5.2	6.01	12.6	62.9	14367	4523	-5.9164	0.5817	0.98	-10.746	4.6465	0.99
WT10-LB	Fine plus	4.33	13.10	0.000400	2.95	5.2	6.01	12.6	62.9	6737	4218	-6.6509	0.7205	0.98	-11.015	4.9074	0.98
WT17-AB	Fine	5.49	10.54	0.000197	3.40	4.6	5.48	13.8	60.7	1099999	3802	-5.9215	0.3963	0.94	-10.808	3.9476	0.96

Specimen Name	Grad. Type	AC (%)	AV (%)	Test Strain	Rs4s50	M200 (%)	SA (m ² /kg)	VMA (%)	VFA (%)	nf	Stif (MPa)	Ln(-ln(SR))=aa+bb*ln(n)			Ln(-ln(SR))=cc+dd*ln(ln(n))		
												aa	bb	R ²	cc	dd	R ²
WT17-BB	Fine	5.49	10.31	0.000201	3.40	4.6	5.48	13.8	60.7	1305955	3963	-6.0485	0.4130	0.96	-10.721	3.8911	0.99
WT17-DB	Fine	5.49	10.85	0.000201	3.40	4.6	5.48	13.8	60.7	1017455	3912	-6.0648	0.4256	0.96	-10.778	3.9617	0.99
WT17-EB	Fine	5.49	10.45	0.000398	3.40	4.6	5.48	13.8	60.7	55658	3794	-5.8271	0.5023	0.99	-10.592	4.2672	0.99
WT17-CB	Fine	5.49	10.63	0.000402	3.40	4.6	5.48	13.8	60.7	49949	3745	-6.2964	0.5550	0.98	-10.813	4.3663	0.99
WT17-FB	Fine	5.49	10.43	0.000401	3.40	4.6	5.48	13.8	60.7	45164	3641	-6.0224	0.5352	0.97	-10.046	4.0581	0.99

Table A.4.2 WesTrack Temperature Susceptibility Fatigue Test Results and Weibull Regression Fits at Various Temperatures (Field-mixed and Field-compacted)

Specimen Name	Grad. Type	AC (%)	AV (%)	Temp. (C)	Test Strain	Rs4s50	M200 (%)	SA (m ² /kg)	VMA (%)	VFA (%)	nf	Stif (MPa)	Ln(-ln(SR))=aa+bb*ln(n)			Ln(-ln(SR))=cc+dd*ln(ln(n))		
													aa	bb	R ²	cc	dd	R ²
WT01-CT	Fine	5.69	11.8	5.1	0.000178	3.07	5.1	5.95	13.0	68.1	7495425	7609	-6.0019	0.3667	0.93	-10.713	3.7176	0.98
WT01-ET	Fine	5.69	11.0	5.1	0.000198	3.07	5.1	5.95	13.0	68.1	738687	9100	-9.4758	0.6317	0.94	-15.347	5.3295	0.96
WT01-DT	Fine	5.69	11.1	30.0	0.000397	3.07	5.1	5.95	13.0	68.1	91839	1855	-4.9203	0.4053	0.97	-8.2869	3.2366	0.99
WT15-BT	Fine	5.55	11.1	5.1	0.000299	3.10	5.2	6.14	13.7	63.5	41122	6806	-5.9802	0.5297	0.96	-11.139	4.6035	0.99
WT15-FT	Fine	5.55	10.6	5.2	0.000397	3.10	5.2	6.14	13.7	63.5	8784	7252	-7.9081	0.8426	0.95	-13.149	5.8077	0.98
WT15-DT	Fine	5.55	10.5	21.6	0.000199	3.10	5.2	6.14	13.7	63.5	204774	4125	-6.2093	0.4772	0.95	-10.374	3.9110	0.98
WT15-AT	Fine	5.55	10.9	21.0	0.000300	3.10	5.2	6.14	13.7	63.5	27555	3505	-6.3322	0.5829	0.98	-11.834	4.9858	0.99
WT15-CT	Fine	5.55	11.7	30.0	0.000201	3.10	5.2	6.14	13.7	63.5	376450	1530	-5.3141	0.3945	0.94	-9.3774	3.5272	0.97
WT15-ET	Fine	5.55	10.8	30.1	0.000299	3.10	5.2	6.14	13.7	63.5	82025	1866	-5.6204	0.4682	0.98	-9.7883	3.8631	0.99
WT17-FT	Fine	5.90	12.7	19.7	0.000179	3.15	5.1	6.16	14.0	66.0	1846222	3500	-6.2396	0.3897	0.93	-10.451	3.5832	0.94
WT17-ET	Fine	5.90	12.8	20.1	0.000400	3.15	5.1	6.16	14.0	66.0	66914	3515	-6.6638	0.5715	0.93	-10.823	4.2589	0.97
WT17-CT	Fine	5.90	12.5	30.1	0.000178	3.15	5.1	6.16	14.0	66.0	5212204	1536	-5.2271	0.3199	0.92	-9.2519	3.2086	0.97
WT19-ET	Fine plus	5.41	8.4	5.1	0.000178	2.87	5.8	6.53	11.7	95.1	923182	9232	-8.1197	0.5396	0.93	-14.244	5.0461	0.97
WT19-FT	Fine plus	5.41	9.3	5.1	0.000296	2.87	5.8	6.53	11.7	95.1	144082	9633	-8.0717	0.6346	0.98	-13.278	5.0377	0.99
WT19-CT	Fine plus	5.41	9.4	30.2	0.000181	2.87	5.8	6.53	11.7	95.1	820324	1874	-4.9709	0.3419	0.98	-8.6952	3.1668	0.97
WT21-AT	Fine plus	6.25	8.1	5.1	0.000400	2.94	5.4	6.41	12.1	87.1	25615	5551	-5.4846	0.5033	0.98	-9.0106	3.6489	0.99
WT21-BT	Fine plus	6.25	6.5	19.5	0.000401	2.94	5.4	6.41	12.1	87.1	25559	4424	-6.4127	0.6030	0.98	-10.255	4.2089	0.99
WT11-ET	Fine plus	5.50	8.8	19.7	0.000178	3.10	5.5	6.29	11.8	84.0	1191716	5245	-6.6121	0.4262	0.95	-10.850	3.7483	0.96
WT12-ET	Fine plus	5.35	5.0	5.1	0.000196	2.92	6.0	6.49	11.6	87.5	3872422	13766	-8.7643	0.5172	0.97	-15.898	5.4091	0.94
WT12-FT	Fine plus	5.35	4.5	19.8	0.000198	2.92	6.0	6.49	11.6	87.5	3308278	7769	-7.2349	0.4497	0.93	-13.325	4.6713	0.96
WT12-DT	Fine plus	5.35	5.3	20.2	0.000298	2.92	6.0	6.49	11.6	87.5	194603	6511	-5.7592	0.4304	0.99	-9.9335	3.7004	0.99
WT12-AT	Fine plus	5.35	7.5	30.1	0.000199	2.92	6.0	6.49	11.6	87.5	925205	2410	-4.9055	0.3368	0.97	-8.6591	3.1475	0.99
WT12-CT	Fine plus	5.35	7.6	30.1	0.000300	2.92	6.0	6.49	11.6	87.5	174999	2037	-5.6335	0.4473	0.95	-9.6422	3.7177	0.98
WT12-BT	Fine plus	5.35	8.9	30.1	0.000404	2.92	6.0	6.49	11.6	87.5	49999	1741	-5.2460	0.4567	0.95	-9.2617	3.7567	0.99
WT05-CT	Coarse	5.67	7.5	20.0	0.000399	3.43	6.5	5.55	12.1	77.6	195440	5336	-6.7519	0.5361	0.93	-11.996	4.6670	0.97
WT05-BT	Coarse	5.67	7.0	30.0	0.000806	3.43	6.5	5.55	12.1	77.6	17608	2185	-5.3318	0.5227	0.94	-8.9199	3.7810	0.98
WT05-FT	Coarse	5.67	7.5	29.9	0.000797	3.43	6.5	5.55	12.1	77.6	14160	2079	-4.8688	0.4752	0.97	-8.3024	3.5292	0.99
WT23-BT	Coarse	5.78	6.0	5.1	0.000197	3.37	7.0	5.88	12.0	71.8	1409614	12312						
WT23-CT	Coarse	5.78	5.5	5.2	0.000297	3.37	7.0	5.88	12.0	71.8	645455	11868	-9.9549	0.7318	0.98	-18.722	7.0618	0.99
WT23-DT	Coarse	5.78	7.1	20.1	0.000199	3.37	7.0	5.88	12.0	71.8	2166426	6686	-4.6483	0.2725	0.99	-7.3762	2.4115	0.96
WT23-AT	Coarse	5.78	5.5	20.0	0.000397	3.37	7.0	5.88	12.0	71.8	151923	6902	-6.2167	0.4937	0.97	-10.317	3.9412	0.99
WT23-FT	Coarse	5.78	6.0	30.2	0.000400	3.37	7.0	5.88	12.0	71.8	182077	2970	-4.8105	0.3737	0.96	-8.6606	3.3485	0.99
WT23-ET	Coarse	5.78	7.2	29.8	0.000400	3.37	7.0	5.88	12.0	71.8	154032	2286	-5.4101	0.4357	0.92	-9.1565	3.5397	0.97
WT24-BT	Coarse	5.91	7.6	5.2	0.000397	3.42	6.6	5.65	12.1	79.2	176290	9171	-9.2719	0.7524	0.92	-17.556	6.8974	0.95
WT24-FT	Coarse	5.91	6.6	19.6	0.000198	3.42	6.6	5.65	12.1	79.2	3047948	5693	-6.0251	0.3560	0.97	-9.9565	3.3291	0.93

Table A.4.3 WesTrack Temperature Susceptibility Fatigue Test Results and Weibull Regression Fits at Various Temperatures (Laboratory-mixed and Laboratory-compacted)

Specimen Name	Grad. Type	AC (%)	AV (%)	Temp. (C)	Test Strain	Rs4s50	M200 (%)	SA (m ² /kg)	VMA (%)	VFA (%)	nf	Stif (MPa)	Ln(-ln(SR))=aa+bb*ln(n)			Ln(-ln(SR))=cc+dd*ln(ln(n))		
													aa	bb	R ²	cc	dd	R ²
WTCM57-3AA	CM	5.7	8.7	5	0.000199	4.40	4.8	4.30	13.4	79.0	4199446	13018	-8.5300	0.4377	0.90	-14.107	4.4274	0.87
WTCM57-8CA	CM	5.7	7.9	5	0.000199	4.40	4.8	4.30	13.4	79.0	3630781	12567	-7.8625	0.3856	0.96	-12.600	3.7830	0.92
WTCM57-12CA	CM	5.7	8.2	5	0.000399	4.40	4.8	4.30	13.4	79.0	63473	12076	-8.8014	0.7556	0.98	-14.515	5.7509	0.98
WTCM57-2CB	CM	5.7	7.7	5	0.000399	4.40	4.8	4.30	13.4	79.0	51908	12767	-14.973	1.3342	0.98	-28.956	11.880	0.98
WTCM57-12CB	CM	5.7	7.9	20	0.000198	4.40	4.8	4.30	13.4	79.0	4996639	5202	-6.0564	0.3844	0.97	-10.543	3.6959	0.98
WTCM57-20CA	CM	5.7	8.5	20	0.000198	4.40	4.8	4.30	13.4	79.0	4102125	5771	-5.7896	0.3682	0.94	-10.359	3.6597	0.99
WTCM57-14CB	CM	5.7	7.8	20	0.000396	4.40	4.8	4.30	13.4	79.0	123075	5517	-5.9302	0.4845	0.98	-10.168	3.9775	0.99
WTCM57-22CB	CM	5.7	8.1	20	0.000399	4.40	4.8	4.30	13.4	79.0	122160	5221	-5.7284	0.4700	0.96	-9.7348	3.8043	0.99
WTCM57-25AA	CM	5.7	8.8	30	0.000200	4.40	4.8	4.30	13.4	79.0	14467692	2746	-4.2301	0.2363	0.98	-7.8309	2.6126	0.99
WTCM57-10CB	CM	5.7	7.9	30	0.000202	4.40	4.8	4.30	13.4	79.0	8852903	2905	-4.5894	0.2746	0.95	-7.9846	2.7241	0.99
WTCM57-16CA	CM	5.7	8.3	30	0.000397	4.40	4.8	4.30	13.4	79.0	524424	2590	-4.0600	0.2819	0.99	-7.6092	2.7923	0.99
WTCM57-22CA	CM	5.7	7.6	30	0.000398	4.40	4.8	4.30	13.4	79.0	444880	2444	-4.1662	0.2934	0.99	-7.5486	2.7671	0.99
WTFM54-4AB	FM	5.4	8.3	5	0.000199	3.49	4.0	5.07	13.7	86.0	1758811	11939	-6.1112	0.3606	0.96	-10.875	3.6739	0.93
WTFM54-1CA	FM	5.4	8.7	5	0.000199	3.49	4.0	5.07	13.7	86.0	813040	9184	-10.972	0.7168	0.95	-20.848	7.4437	0.95
WTFM54-6AA	FM	5.4	8.0	5	0.000399	3.49	4.0	5.07	13.7	86.0	46541	10220	-8.9782	0.8200	0.99	-16.717	6.9354	0.99
WTFM54-3CB	FM	5.4	7.7	5	0.000399	3.49	4.0	5.07	13.7	86.0	41750	11332	-9.4544	0.8410	0.98	-16.610	6.7281	0.98
WTFM54-5CB	FM	5.4	7.8	20	0.000201	3.49	4.0	5.07	13.7	86.0	1005114	5342	-5.7862	0.4040	0.97	-10.218	3.7499	0.98
WTFM54-1CB	FM	5.4	8.7	20	0.000199	3.49	4.0	5.07	13.7	86.0	699999	4905	-5.5179	0.3937	0.98	-9.4949	3.4928	0.99
WTFM54-4AA	FM	5.4	7.5	20	0.000401	3.49	4.0	5.07	13.7	86.0	92708	4744	-5.3010	0.4249	0.97	-8.7509	3.3549	0.99
WTFM54-2AB	FM	5.4	9.1	20	0.000402	3.49	4.0	5.07	13.7	86.0	65837	4004	-5.2058	0.4300	0.99	-9.3536	3.6736	0.99
WTFM54-3CA	FM	5.4	8.0	30	0.000200	3.49	4.0	5.07	13.7	86.0	3399999	2745	-4.7137	0.2880	0.98	-8.4479	2.9247	0.99
WTFM54-2AA	FM	5.4	9.6	30	0.000200	3.49	4.0	5.07	13.7	86.0	2514857	2333	-4.9599	0.3166	0.93	-8.6495	3.0373	0.97
WTFM54-4CB	FM	5.4	8.2	30	0.000400	3.49	4.0	5.07	13.7	90.0	347105	2580	-4.8815	0.3667	0.94	-8.4040	3.1606	0.98
WTFM54-5CA	FM	5.4	7.7	30	0.000396	3.49	4.0	5.07	13.7	86.0	184006	2872	-4.8908	0.3863	0.94	-8.3383	3.2009	0.98

Table A.4.4 High Temperature Fatigue Test Results and Weibull Regression Fits

Specimen Name	Grad. Type	AC (%)	AV (%)	Temp. (C)	Test Strain	Rs4s50	M200 (%)	SA (m ² /kg)	VMA (%)	VFA (%)	nf	Stif (MPa)	Ln(-ln(SR))=aa+bb*ln(n)			Ln(-ln(SR))=cc+dd*ln(ln(n))		
													aa	bb	R ²	cc	dd	R ²
WTCM57-8CB	CM	5.7	7.4	30	0.000400	4.40	4.8	4.30	13.4	79.0	8.3342E+04	4410	-6.2305	0.5302	0.92	-10.311	4.0654	0.97
WTCM57-14CA	CM	5.7	7.6	40	0.000200	4.40	4.8	4.30	13.4	79.0	4.4743E+06	2083	-4.7463	0.2903	0.82	-8.9985	3.1495	0.91
WTCM57-18CB	CM	5.7	7.0	30	0.000200	4.40	4.8	4.30	13.4	79.0	2.0300E+07	4102	-5.0726	0.2981	0.92	-8.8824	2.9858	0.96
WTCM57-24CA	CM	5.7	6.0	40	0.000400	4.40	4.8	4.30	13.4	79.0	4.4990E+07	985	-4.8130	0.2783	0.87	-8.0648	2.6526	0.92
WTCM57-7AA	CM	5.7	10.5	30	0.000200	4.40	4.8	4.30	13.4	79.0	1.1874E+07	3862	-4.8784	0.2892	0.96	-8.7649	2.9834	0.98
WTCM57-9AA	CM	5.7	10.5	40	0.000400	4.40	4.8	4.30	13.4	79.0	8.0756E+05	859	-8.1222	0.5845	0.90	-15.063	5.5915	0.93
WTCM57-31AA	CM	5.7	10.7	30	0.000400	4.40	4.8	4.30	13.4	79.0	6.5414E+05	3198	-3.9916	0.2766	0.98	-7.0546	2.5615	0.99
WTCM57-31AB	CM	5.7	10.6	40	0.000200	4.40	4.8	4.30	13.4	79.0	3.1932E+06	1009	-6.8572	0.4673	0.87	-11.446	4.0438	0.91
WTFM57-5AB	FM	5.7	7.1	30	0.000200	3.49	4.0	5.07	13.7	90.0	1.1056E+08	4591	-4.0277	0.2323	0.95	-6.1888	1.9710	0.96
WTFM57-6CB	FM	5.7	6.5	40	0.000400	3.49	4.0	5.07	13.7	90.0	4.8189E+06	1105	-4.8479	0.3272	0.87	-7.5708	2.5993	0.93
WTFM57-15AA	FM	5.7	6.1	30	0.000400	3.49	4.0	5.07	13.7	90.0	7.3782E+05	4562	-4.2526	0.3115	0.95	-6.5981	2.3607	0.99
WTFM57-18CA	FM	5.7	6.1	40	0.000200	3.49	4.0	5.07	13.7	90.0	7.6423E+08	1883	-4.3313	0.2277	0.89	-7.0017	2.1752	0.94
WTFM57-3AA	FM	5.7	10.5	30	0.000400	3.49	4.0	5.07	13.7	90.0	1.2319E+05	2707	-7.5067	0.6095	0.88	-13.968	5.5246	0.96
WTFM57-11AA	FM	5.7	10.7	40	0.000200	3.49	4.0	5.07	13.7	90.0	2.5685E+05	1171	-8.9583	0.7687	0.80	-12.091	4.5711	0.90
WTFM57-26CB	FM	5.7	11.0	30	0.000200	3.49	4.0	5.07	13.7	90.0	5.4376E+10	3261	-3.2305	0.1464	0.79	-5.017	1.4375	0.88
WTFM57-30CB	FM	5.7	11.6	40	0.000400	3.49	4.0	5.07	13.7	90.0	1.0388E+07	850	-5.9408	0.3880	0.91	-9.3423	3.1839	0.96

Table A.4.5 Fatigue Test Results and Weibull Regression Fits with Various Gradation Types

Specimen Name	Grad. Type	AC (%)	AV (%)	Temp. (C)	Test Strain	Rs4s50	M200 (%)	SA (m ² /kg)	VMA (%)	VFA (%)	nf	Stif (MPa)	Ln(-ln(SR))=aa+bb*ln(n)			Ln(-ln(SR))=cc+dd*ln(ln(n))		
													aa	bb	R ²	cc	dd	R ²
WTCH57-1CA	CH	5.7	10.8	20	0.000305	3.33	7.1	6.28	13.4		632624	3105	-5.4063	0.3723	0.99	-9.2051	3.3091	0.99
WTCH57-1CB	CH	5.7	8.6	20	0.000301	3.33	7.1	6.28	13.4		218936	4547	-6.1766	0.4821	0.98	-11.081	4.2837	0.99
WTCH57-2AA	CH	5.7	8.3	20	0.000508	3.33	7.1	6.28	13.4		84999	3730	-4.9603	0.4102	0.99	-9.1591	3.6240	0.99
WTCH57-2AB	CH	5.7	10.3	20	0.000500	3.33	7.1	6.28	13.4		52601	4163	-5.8691	0.5155	0.96	-9.6658	3.8657	0.99
WTCM57-12CB	CM	5.7	7.9	20	0.000198	4.40	4.8	4.30	13.4		4996639	5202	-6.0564	0.3844	0.97	-10.543	3.6959	0.98
WTCM57-20CA	CM	5.7	8.5	20	0.000198	4.40	4.8	4.30	13.4		4102125	5771	-5.7896	0.3682	0.94	-10.359	3.6597	0.99
WTCM57-14CB	CM	5.7	7.8	20	0.000396	4.40	4.8	4.30	13.4		123075	5517	-5.9302	0.4845	0.98	-10.168	3.9775	0.99
WTCM57-22CB	CM	5.7	8.1	20	0.000399	4.40	4.8	4.30	13.4		122160	5221	-5.7284	0.4700	0.96	-9.7348	3.8043	0.99
WTCL57-2AA	CL	5.7	7.7	20	0.000298	7.38	3.2	2.94	14.9		931499	5295	-5.2821	0.3517	0.99	-9.2976	3.3159	0.98
WTCL57-1CB	CL	5.7	7.7	20	0.000300	7.38	3.2	2.94	14.9		712167	5925	-5.5378	0.3972	0.96	-10.042	3.7391	0.99
WTCL57-1CA	CL	5.7	8.0	20	0.000497	7.38	3.2	2.94	14.9		109928	4703	-4.9920	0.3960	0.99	-8.7433	3.3646	0.99
WTCL57-2AB	CL	5.7	7.3	20	0.000497	7.38	3.2	2.94	14.9		84038	5051	-5.6215	0.4739	0.95	-9.5071	3.7555	0.99
WTFH54-2AB	FH	5.4	8.5	20	0.000299	3.03	7.5	7.20	13.9		91724	6370	-6.3676	0.5323	0.96	-10.822	4.2659	0.99
WTFH54-2AA	FH	5.4	9.3	20	0.000297	3.03	7.5	7.20	13.9		58298	5338	-5.8685	0.4831	0.97	-9.3232	3.5705	0.99
WTFH54-1CB	FH	5.4	9.4	20	0.000502	3.03	7.5	7.20	13.9		19696	4537	-6.3528	0.6162	0.95	-10.355	4.3382	0.98
WTFH54-1CA	FH	5.4	8.5	20	0.000500	3.03	7.5	7.20	13.9		8131	5678	-6.5804	0.6799	0.99	-10.402	4.4653	0.99
WTFM54-5CB	FM	5.4	7.8	20	0.000201	3.49	4.0	5.07	13.7		1005114	5342	-5.7862	0.4040	0.97	-10.218	3.7499	0.98
WTFM54-1CB	FM	5.4	8.7	20	0.000199	3.49	4.0	5.07	13.7		699999	4905	-5.5179	0.3937	0.98	-9.4949	3.4928	0.99
WTFM54-4AA	FM	5.4	7.5	20	0.000401	3.49	4.0	5.07	13.7		92708	4744	-5.3010	0.4249	0.97	-8.7509	3.3549	0.99
WTFM54-2AB	FM	5.4	9.1	20	0.000402	3.49	4.0	5.07	13.7		65837	4004	-5.2058	0.4300	0.99	-9.3536	3.6736	0.99
WTFL54-2AA	FL	5.4	6.4	20	0.000298	5.46	2.6	3.45	13.8		719748	5152	-5.1794	0.3542	0.97	-8.6444	3.0869	0.99
WTFL54-1CA	FL	5.4	6.5	20	0.000303	5.46	2.6	3.45	13.8		487122	4855	-5.4652	0.3899	0.95	-9.1420	3.3296	0.99
WTFL54-2AB	FL	5.4	6.8	20	0.000499	5.46	2.6	3.45	13.8		49999	5152	-5.3535	0.4689	0.98	-9.0632	3.6513	0.99
WTFL54-1CB	FL	5.4	7.5	20	0.000501	5.46	2.6	3.45	13.8		35444	4796	-5.8694	0.5375	0.96	-9.7494	3.9901	0.99

Table A.4.6 Correlation Matrix of Fatigue Tests at 20°C

	grad	ac	av	lnstn	rs4s50	m200	Sa	vma	vfa	lnstif	lnnf	aa	bb	cc	dd
grad	1.000														
av	-0.190	1.000													
ac	-0.270	-0.475	1.000												
lnstn	0.026	-0.016	-0.054	1.000											
rs4s50	-0.259	0.295	0.300	-0.012	1.000										
m200	0.691	0.153	-0.174	-0.045	0.194	1.000									
sa	0.610	-0.235	-0.455	0.020	-0.793	0.317	1.000								
vma	-0.763	0.101	0.358	0.020	0.681	-0.460	-0.814	1.000							
vfa	0.553	0.465	-0.687	0.004	-0.461	0.425	0.602	-0.757	1.000						
lnstif	0.339	0.153	-0.634	-0.140	0.100	0.389	0.215	-0.151	0.307	1.000					
lnnf	0.004	0.295	-0.177	-0.907	0.078	0.154	-0.041	-0.052	0.191	0.245	1.000				
aa	0.037	0.042	-0.176	-0.226	-0.162	0.019	0.137	-0.126	0.145	0.029	0.342	1.000			
bb	-0.047	-0.261	0.220	0.770	-0.032	-0.181	-0.026	0.082	-0.203	-0.231	-0.891	-0.687	1.000		
cc	0.095	-0.030	-0.119	-0.090	-0.060	0.102	0.089	-0.078	0.086	0.066	0.191	0.884	-0.537	1.000	
dd	-0.094	-0.160	0.186	0.580	-0.055	-0.216	-0.026	0.067	-0.160	-0.227	-0.700	-0.778	0.899	-0.812	1.000

Table A.4.7 Correlation Matrix of Temperature Susceptibility Fatigue Tests (Field-mixed and Field-compacted)

	grad	ac	av	temp	lnstn	rs4s50	m200	sa	vma	vfa	lnstif	lnnf	aa	bb	cc	dd
grad	1.000															
Ac	-0.256	1.000														
av	-0.706	0.079	1.000													
temp	-0.010	-0.118	0.015	1.000												
lnstn	0.000	0.261	-0.223	0.194	1.000											
rs4s50	-0.387	0.440	-0.167	0.139	0.425	1.000										
m200	0.409	0.035	-0.789	0.131	0.328	0.590	1.000									
sa	0.501	-0.425	0.033	-0.081	-0.447	-0.942	-0.421	1.000								
vma	-0.905	0.245	0.835	-0.001	-0.111	0.091	-0.674	-0.173	1.000							
vfa	0.953	-0.286	-0.562	-0.070	-0.049	-0.469	0.279	0.516	-0.848	1.000						
lnstif	0.175	0.023	-0.340	-0.897	-0.225	-0.022	0.153	0.029	-0.233	0.175	1.000					
lnnf	0.085	-0.149	-0.048	-0.105	-0.828	-0.098	0.047	0.135	-0.127	0.121	0.247	1.000				
aa	-0.033	0.037	0.124	0.769	0.155	0.044	-0.000	-0.022	0.059	-0.084	-0.766	-0.142	1.000			
bb	-0.081	0.094	-0.030	-0.608	0.375	0.049	-0.051	-0.089	0.089	-0.058	0.497	-0.496	-0.766	1.000		
cc	-0.033	0.087	0.161	0.736	0.153	0.017	-0.050	-0.006	0.073	-0.074	-0.735	-0.166	0.976	-0.736	1.000	
dd	-0.026	-0.042	-0.124	-0.697	0.090	0.034	0.036	-0.053	-0.003	0.003	0.644	-0.126	-0.919	0.889	-0.951	1.000

Table A.4.8 Correlation Matrix of Temperature Susceptibility Fatigue Tests (Laboratory-mixed and Laboratory-compacted)

	grad	ac	av	temp	lnstn	rs4s50	m200	sa	vma	vfa	lnstif	lnnf	aa	bb	cc	dd
grad	1.000															
ac	-1.000	1.000														
av	0.155	-0.155	1.000													
temp	0.000	0.000	0.086	1.000												
lnstn	0.004	-0.004	-0.398	0.002	1.000											
rs4s50	-1.000	1.000	-0.155	0.000	-0.004	1.000										
m200	-1.000	1.000	-0.155	0.000	-0.004	1.000	1.000									
sa	1.000	-1.000	0.155	0.000	0.004	-1.000	-1.000	1.000								
vma	1.000	-1.000	0.155	0.000	0.004	-1.000	-1.000	1.000	1.000							
vfa	0.941	-0.941	0.135	0.082	0.076	-0.941	-0.941	0.941	0.941	1.000						
lnstif	-0.089	0.089	-0.151	-0.986	-0.034	0.089	0.089	-0.089	-0.089	-0.164	1.000					
lnnf	-0.256	0.256	0.323	0.313	-0.878	0.256	0.256	-0.256	-0.256	-0.244	-0.264	1.000				
aa	0.065	-0.065	0.139	0.810	-0.117	-0.065	-0.065	0.065	0.065	0.104	-0.794	0.381	1.000			
bb	0.007	-0.007	-0.241	-0.684	0.395	-0.007	-0.007	0.007	0.007	-0.026	0.663	-0.633	-0.930	1.000		
cc	0.044	-0.044	0.125	0.755	-0.123	-0.044	-0.044	0.044	0.044	0.086	-0.732	0.378	0.991	-0.936	1.000	
dd	-0.010	0.010	-0.175	-0.698	0.257	0.010	0.010	-0.010	-0.010	-0.049	0.672	-0.502	-0.966	0.979	-0.983	1.000

Table A.4.9 Correlation Matrix of High Temperature Fatigue Tests

	grad	av	temp	lnstn	rs4s50	m200	sa	vma	vfa	lnstif	lnnf	aa	bb	cc	dd
grad	1.000														
av	-0.021	1.000													
temp	0.000	-0.021	1.000												
lnstn	0.000	-0.039	0.000	1.000											
rs4s50	-1.000	0.021	0.000	0.000	1.000										
m200	-1.000	0.021	0.000	0.000	1.000	1.000									
sa	1.000	-0.021	0.000	0.000	-1.000	-1.000	1.000								
vma	1.000	-0.021	0.000	0.000	-1.000	-1.000	1.000	1.000							
vfa	1.000	-0.021	0.000	0.000	-1.000	-1.000	1.000	1.000	1.000						
lnstif	-0.004	-0.236	-0.914	-0.203	0.004	0.004	-0.004	-0.004	-0.004	1.000					
lnnf	0.254	-0.107	-0.006	-0.503	-0.254	-0.254	0.254	0.254	0.254	0.073	1.000				
aa	0.064	-0.424	-0.373	-0.142	-0.064	-0.063	0.064	0.064	0.064	0.499	0.644	1.000			
bb	-0.001	0.384	0.244	0.224	0.001	0.001	-0.001	-0.001	-0.001	-0.364	-0.742	-0.969	1.000		
cc	0.248	-0.422	-0.293	-0.220	-0.248	-0.248	0.248	0.248	0.248	0.436	0.655	0.932	-0.874	1.000	
dd	-0.225	0.410	0.217	0.279	0.225	0.225	-0.225	-0.225	-0.225	-0.362	-0.724	-0.928	0.902	-0.991	1.000

Table A.4.10 Correlation Matrix of Fatigue Tests with Various Gradation Types

	grad	ac	av	lnstn	rs4s50	m200	sa	vma	lnstif	lnnf	Aa	bb	cc	dd
grad	1.000													
ac	-0.878	1.000												
av	-0.369	0.200	1.000											
lnstn	-0.190	-0.002	0.018	1.000										
rs4s50	-0.029	0.293	-0.680	-0.007	1.000									
m200	-0.314	0.098	0.743	0.002	-0.886	1.000								
sa	0.029	-0.293	0.680	0.007	-1.000	0.886	1.000							
vma	0.065	-0.224	-0.293	0.246	0.327	-0.262	-0.327	1.000						
lnstif	0.282	-0.175	-0.509	-0.285	0.227	-0.109	-0.227	0.403	1.000					
lnnf	-0.077	0.347	-0.168	-0.854	0.376	-0.274	-0.376	-0.267	0.118	1.000				
aa	0.001	0.146	-0.270	0.075	0.533	-0.605	-0.533	0.014	-0.411	0.246	1.000			
bb	0.055	-0.314	0.244	0.561	-0.528	0.504	0.528	0.183	0.160	-0.820	-0.740	1.000		
cc	0.172	-0.138	-0.238	0.284	0.389	-0.535	-0.389	0.167	-0.384	-0.062	0.847	-0.446	1.000	
dd	-0.101	-0.068	0.264	0.270	-0.505	0.573	0.505	0.005	0.262	-0.516	-0.849	0.852	-0.816	1.000

Table A.4.11 Correlation Matrix of Pooled Fatigue Tests

	grad	ac	av	temp	lnstn	rs4s50	m200	sa	vma	vfa	lnstif	lnnf	aa	bb	cc	dd
grad	1.000															
ac	-0.165	1.000														
av	-0.314	-0.401	1.000													
temp	-0.075	0.031	0.032	1.000												
lnstn	0.011	0.016	-0.079	0.056	1.000											
rs4s50	-0.195	0.250	0.170	0.192	0.032	1.000										
m200	0.643	0.135	-0.201	-0.123	0.030	-0.090	1.000									
sa	0.475	-0.198	-0.283	-0.196	-0.025	-0.878	0.433	1.000								
vma	-0.762	0.081	0.377	0.087	-0.015	0.526	-0.593	-0.686	1.000							
vfa	0.409	0.372	-0.581	0.099	0.010	-0.179	0.137	0.261	-0.589	1.000						
lnstif	0.207	0.020	-0.341	-0.845	-0.132	-0.064	0.209	0.148	-0.131	0.043	1.000					
lnnf	-0.057	0.223	-0.109	0.232	-0.760	0.195	-0.065	-0.189	0.040	0.230	-0.058	1.000				
aa	-0.015	0.022	-0.055	0.581	-0.071	-0.030	-0.036	0.013	0.001	0.048	-0.450	0.288	1.000			
bb	-0.010	-0.156	0.126	-0.439	0.521	-0.081	-0.020	0.061	0.014	-0.149	0.259	-0.715	-0.815	1.000		
cc	-0.006	0.007	-0.023	0.587	-0.038	-0.026	-0.029	0.012	0.021	0.032	-0.454	0.242	0.967	-0.765	1.000	
dd	-0.007	-0.079	0.062	-0.546	0.284	-0.037	0.003	0.031	-0.015	-0.090	0.378	-0.491	-0.923	0.910	-0.950	1.000

Table A.4.12 Correlation Matrix of Coarse Gradation

	ac	av	temp	lnstn	rs4s50	m200	sa	vma	vfa	lnstif	lnnf	aa	bb	cc	dd
ac	1.000														
av	-0.450	1.000													
temp	-0.084	0.009	1.000												
lnstn	-0.002	-0.165	0.103	1.000											
rs4s50	-0.231	-0.004	0.240	-0.024	1.000										
m200	0.094	-0.140	-0.187	0.069	-0.927	1.000									
sa	0.136	-0.101	-0.229	0.053	-0.966	0.982	1.000								
vma	-0.073	0.169	-0.026	-0.078	0.511	-0.665	-0.536	1.000							
vfa	0.469	-0.324	0.154	0.029	0.183	-0.151	-0.246	-0.494	1.000						
lnstif	0.092	-0.240	-0.897	-0.182	-0.148	0.151	0.182	0.077	-0.167	1.000					
lnnf	0.087	-0.038	0.177	-0.851	0.174	-0.155	-0.184	-0.042	0.221	-0.090	1.000				
aa	0.022	-0.036	0.622	-0.064	-0.016	0.027	0.023	-0.047	0.053	-0.496	0.241	1.000			
bb	-0.064	0.053	-0.472	0.476	-0.034	0.018	0.028	0.041	-0.097	0.337	-0.643	-0.867	1.000		
cc	0.012	-0.002	0.567	-0.074	-0.037	0.028	0.036	0.003	-0.009	-0.449	0.212	0.980	-0.858	1.000	
dd	-0.028	0.010	-0.511	0.280	0.007	-0.001	-0.006	-0.008	-0.012	0.385	-0.418	-0.941	0.948	-0.968	1.000

Table A.4.13 Correlation Matrix of Fine Gradation

	ac	av	temp	lnstn	rs4s50	m200	sa	vma	vfa	lnstif	lnnf	aa	bb	cc	dd
ac	1.000														
av	-0.550	1.000													
temp	0.077	-0.021	1.000												
lnstn	-0.014	-0.023	0.023	1.000											
rs4s50	-0.115	-0.087	0.283	0.054	1.000										
m200	0.228	0.240	-0.231	-0.100	-0.614	1.000									
sa	0.258	0.166	-0.221	-0.117	-0.629	0.970	1.000								
vma	-0.591	0.341	0.138	-0.019	0.162	-0.142	-0.128	1.000							
vfa	0.505	-0.510	0.288	0.055	0.584	-0.494	-0.490	-0.350	1.000						
lnstif	-0.018	-0.325	-0.854	-0.097	-0.066	0.020	0.045	-0.192	-0.042	1.000					
lnnf	0.181	-0.150	0.343	-0.663	0.262	-0.176	-0.183	-0.065	0.366	-0.134	1.000				
aa	0.056	-0.090	0.552	-0.071	0.074	-0.048	-0.061	0.029	0.094	-0.396	0.441	1.000			
bb	-0.160	0.169	-0.459	0.484	-0.129	0.064	0.082	0.056	-0.216	0.271	-0.762	-0.836	1.000		
cc	0.036	-0.057	0.650	-0.016	0.094	-0.072	-0.085	0.044	0.115	-0.485	0.418	0.953	-0.752	1.000	
dd	-0.096	0.107	-0.640	0.252	-0.140	0.093	0.109	0.000	-0.200	0.444	-0.633	-0.919	0.894	-0.951	1.000

Table A.4.14 Correlation Matrix of Fine-plus Gradation

	ac	av	temp	lnstn	rs4s50	m200	sa	vma	vfa	lnstif	lnnf	aa	bb	cc	dd
ac	1.000														
av	-0.728	1.000													
temp	-0.103	0.013	1.000												
lnstn	0.029	-0.063	0.021	1.000											
rs4s50	-0.266	0.089	0.067	-0.010	1.000										
m200	0.279	-0.294	0.035	0.021	-0.279	1.000									
sa	0.288	-0.354	-0.032	0.041	-0.180	0.931	1.000								
vma	-0.458	0.150	-0.002	0.059	0.508	-0.441	-0.259	1.000							
vfa	0.887	-0.680	-0.075	-0.050	-0.470	0.491	0.454	-0.649	1.000						
lnstif	0.129	-0.413	-0.756	-0.131	0.021	0.089	0.170	0.133	0.134	1.000					
lnnf	0.285	-0.315	-0.017	-0.887	-0.044	0.039	0.018	-0.182	0.339	0.222	1.000				
aa	0.048	-0.060	0.619	-0.091	-0.013	-0.112	-0.068	0.208	-0.036	-0.502	0.103	1.000			
bb	-0.251	0.272	-0.280	0.743	0.077	-0.051	-0.053	0.075	-0.272	0.070	-0.821	-0.615	1.000		
cc	0.009	-0.007	0.575	0.023	0.019	-0.111	-0.027	0.264	-0.079	-0.488	-0.058	0.950	-0.474	1.000	
dd	-0.154	0.158	-0.442	0.434	0.027	0.022	-0.047	-0.116	-0.120	0.273	-0.439	-0.863	0.840	-0.854	1.000

Table A.4.15 Correlation Matrix of Fine and Fine-plus Gradations

	grad	ac	av	temp	lnstn	rs4s50	m200	sa	vma	vfa	lnstif	lnnf	aa	bb	cc	dd
grad	1.000															
ac	-0.213	1.000														
av	-0.389	-0.491	1.000													
temp	-0.104	0.036	0.032	1.000												
lnstn	0.011	0.004	-0.043	0.021	1.000											
rs4s50	-0.717	0.043	0.263	0.237	0.015	1.000										
m200	0.808	-0.026	-0.333	-0.158	-0.016	-0.770	1.000									
sa	0.792	-0.008	-0.342	-0.181	-0.024	-0.775	0.978	1.000								
vma	-0.932	0.019	0.438	0.122	-0.001	0.739	-0.822	-0.780	1.000							
vfa	0.471	0.475	-0.655	0.107	0.016	-0.174	0.359	0.303	-0.595	1.000						
lnstif	0.267	-0.023	-0.414	-0.821	-0.101	-0.221	0.242	0.261	-0.261	0.139	1.000					
lnnf	-0.079	0.228	-0.163	0.255	-0.736	0.183	-0.114	-0.133	0.033	0.276	-0.051	1.000				
aa	-0.018	0.054	-0.064	0.565	-0.075	0.051	-0.054	-0.052	0.051	0.040	-0.412	0.352	1.000			
bb	-0.007	-0.184	0.190	-0.410	0.567	-0.049	0.004	0.017	0.028	-0.209	0.205	-0.775	-0.779	1.000		
cc	-0.005	0.026	-0.033	0.630	-0.003	0.057	-0.052	-0.045	0.050	0.048	-0.469	0.293	0.952	-0.682	1.000	
dd	-0.007	-0.107	0.112	-0.593	0.300	-0.067	0.031	0.033	-0.009	-0.157	0.385	-0.579	-0.907	0.878	-0.930	1.000

Table A.4.16 Range of Covariates and Response Variables of Various Fatigue Tests

Variables	Fatigue Test at 20° C (151)		Temperature Susceptibility Fatigue Test (Field-mixed and Field-compacted) (34)		Temperature Susceptibility Fatigue Test (Lab.-mixed and Lab.-compacted) (24)		High Temperature Fatigue Test (16)		Fatigue Test with Various Gradations at 20° C (24)		Pooled Fatigue Test (225)	
	from	to	from	to	From	to	from	to	From	to	from	to
ac	4.33	6.22	5.35	6.25	5.4	5.7	5.7	5.7	5.4	5.7	4.33	6.62
av	1.9	14.7	4.5	12.8	7.5	9.6	6.0	11.6	6.4	10.8	1.9	14.7
temp			5.1	30.2	5	30	30	40			5	40
stn	0.000148	0.000452	0.000178	0.000806	0.000198	0.000402	0.0002	0.0004	0.000198	0.000508	0.000148	0.000806
rs4s50	2.75	3.90	2.87	3.43	3.49	4.40	3.49	4.40	3.03	7.38	2.75	4.40
m200	4.1	6.5	5.1	7.0	4.0	4.8	4.0	4.8	2.6	7.5	4.0	7.0
sa	4.86	6.87	5.55	6.53	4.30	5.07	4.30	5.07	2.94	7.20	4.30	6.87
vma	11.7	14.3	11.6	14.0	13.4	13.7	13.4	13.7	13.4	14.9	11.6	14.3
vfa	52.2	100.0	63.5	95.1	79.0	90.0	79.0	90.0			52.0	100.0
lnstif	7.9697	8.8802	7.3330	9.5300	7.7549	9.4741	6.7452	8.4319	8.0408	8.7594	6.7452	9.5300
lnnf	8.8154	16.1900	9.0807	15.8298	10.6395	16.4874	11.3307	24.7192	9.0034	15.4243	8.8154	24.7192
aa	-7.6598	-4.8522	-9.9549	-4.6483	-14.973	-4.060	-8.9583	-3.2305	-6.5804	-4.9603	-14.9730	-3.2305
ab	0.2986	0.7304	0.2725	0.8426	0.2363	1.3342	0.1464	0.7687	0.3517	0.6799	0.1464	1.3342
cc	-12.6530	-8.4561	-18.7220	-7.3762	-28.9560	-7.5486	-15.063	-5.017	-11.0810	-8.6444	-28.956	-5.017
dd	2.9748	5.1417	2.4115	7.0618	2.6126	11.8800	1.4375	5.5915	3.0869	4.4653	1.4375	11.8800

- Note: 1. lnstif: natural logarithm of stiffness; lnnf: natural logarithm of fatigue life.
 2. aa and bb are the coefficients of the equation: $\ln(-\ln(SR)) = aa + bb * \ln(n)$.
 3. cc and dd are the coefficients of the equation: $\ln(-\ln(SR)) = cc + dd * \ln(\ln(n))$.
 4. The number in parentheses is the sample size.

Table A.4.17 Range of Covariates and Response Variables of Various Gradation Types

Variables	Gradation								Global range (225)	
	Coarse (78)		Fine (82)		Fine-plus (65)		Fine+Fine-plus (147)			
	From	to	From	to	from	to	from	to	from	To
ac	5.37	6.38	4.76	6.62	4.33	6.25	4.33	6.62	4.33	6.62
av	4.05	14.70	3.72	12.80	1.90	13.68	1.90	13.68	1.9	14.7
temp	5	40	5	40	5.1	30.2	5	40	5	40
stn	0.000181	0.000806	0.000148	0.000452	0.000178	0.000404	0.000148	0.000452	0.000148	0.000806
rs4s50	3.33	4.40	3.03	3.49	2.75	3.12	2.75	3.49	2.75	4.40
m200	4.8	7.0	4.0	5.2	4.9	6.5	4.0	6.5	4.0	7.0
sa	4.30	5.88	5.06	6.16	5.95	6.87	5.06	6.87	4.30	6.87
vma	12.0	14.1	13.0	14.3	11.6	12.9	11.6	14.3	11.6	14.3
vfa	56.6	86.5	52.2	90.0	62.9	100	52.2	100	52.2	100
lnstif	6.755769	9.474088	6.745236	9.387566	7.462215	9.529957	6.745236	9.529975	6.745236	9.529957
Lnnf	9.558176	17.62194	9.080687	24.71919	8.81537	15.46445	8.81537	24.7192	8.81537	24.71963
Aa	-14.9730	-3.9916	-10.9720	-3.2305	-8.7643	-4.9055	-10.972	-3.2305	-14.9730	-3.2305
Bb	0.2363	1.3342	0.1464	0.8426	0.2986	0.7205	0.1464	0.8426	0.1464	1.3342
Cc	-28.956	-7.0546	-20.848	-5.017	-15.898	-8.6591	-20.848	-5.017	-28.956	-5.017
Dd	2.4115	11.8800	1.4375	7.4437	2.9748	5.4091	1.4375	7.4437	1.4375	11.8800

Note: the number in parenthesis is the sample size.

Table A.4.18 Summary of frequency sweep tests.

	WTCM57-15AA				WTCM57-15AB		
	Freq. (Hz)	Mod @ 40 C (MPa)	Mod @ 30 C (MPa)	Mod @ 20 C (MPa)	Mod @ 30 C (MPa)	Mod @ 20 C (MPa)	Mod @ 5 C (MPa)
CM Mixes	15	1101	2619	5042	2715	4821	9428
	10	959	2258	4385	2331	4388	9123
	5	736	1757	3522	1755	3656	8534
	2	519	1229	2597	1186	2805	7693
	1	405	945	2052	858	2205	7018
	0.5	325	703	1581	607	1717	6349
	0.2	256	489	1119	380	1183	5445
	0.1	225	376	857	269	870	4765
	0.05	201	303	654	185	631	4109
	0.02	173	241	484	118	298	3270
	0.01	173	222	407	88	275	2709
	FM Mixes	WTFM57-2CB				WTFM57-2CA	
Freq. (Hz)		Mod @ 40 C (MPa)	Mod @ 30 C (MPa)	Mod @ 20 C (MPa)	Mod @ 30 C (MPa)	Mod @ 20 C (MPa)	Mod @ 5 C (MPa)
15		1224	3595	7260	3028	6269	11982
10		1074	3098	6556	2617	5743	11758
5		829	2424	5496	2005	4851	11046
2		578	1710	4234	1393	3793	10041
1		449	1307	3419	1022	3034	9208
0.5		351	990	2718	742	2411	8414
0.2		268	694	1956	477	1719	7315
0.1		224	525	1513	342	1311	6500
0.05		197	401	1180	246	990	5688
0.02		176	308	830	159	663	4649
0.01	N/A	263	622	119	493	3904	

Note:

1. Mod. stands for modulus.
2. WTCM57-15AA and WTFM57-2CB were conducted using the modified fatigue test setup.
3. WTCM57-15AB and WTFM57-2CA were conducted using the conventional fatigue test setup.

APPENDIX B:

FIGURES

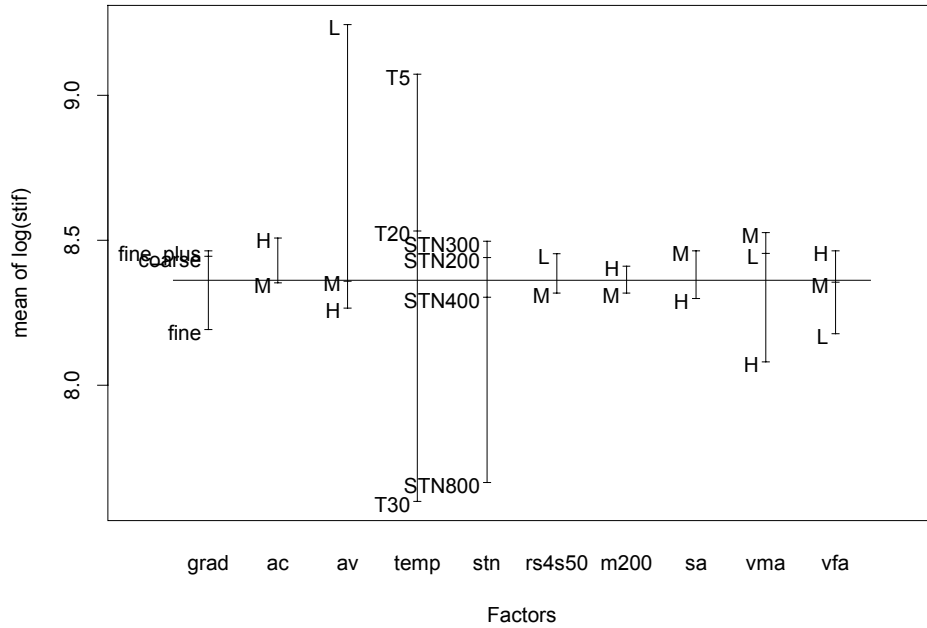

Figure B.4.1. Design plot of $lnstif$ (temperature susceptibility fatigue test, field-mixed and field-compacted).

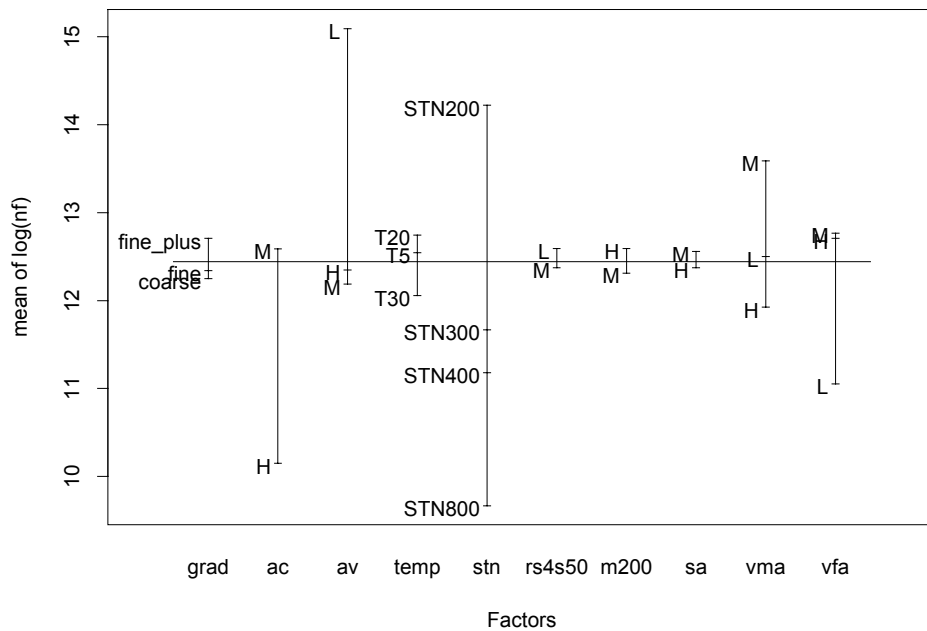

Figure B.4.2. Design plot of $lnnf$ (temperature susceptibility fatigue test, field-mixed and field-compacted).

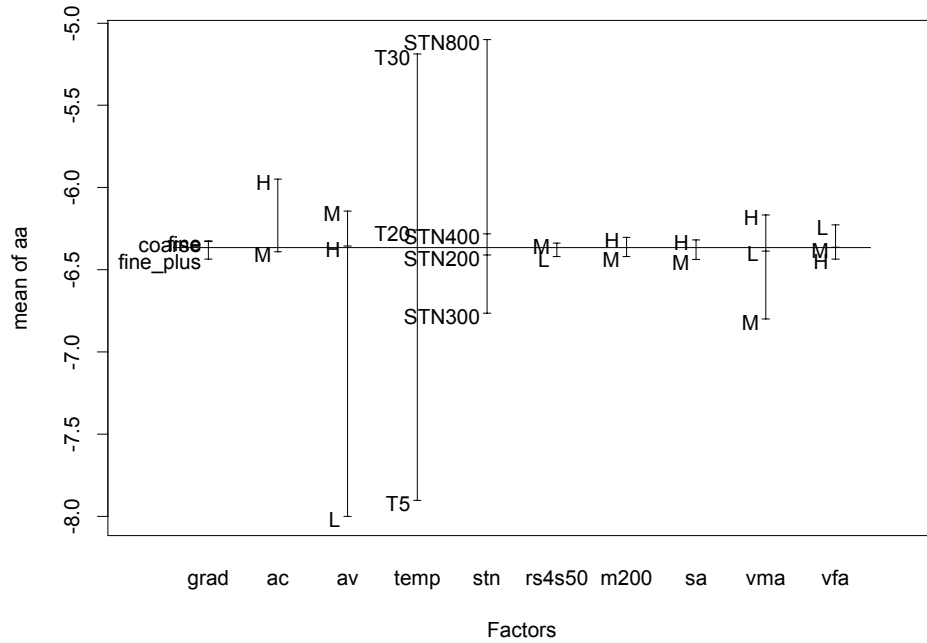

Figure B.4.3. Design plot of *aa* (temperature susceptibility fatigue test, field-mixed and field-compacted).

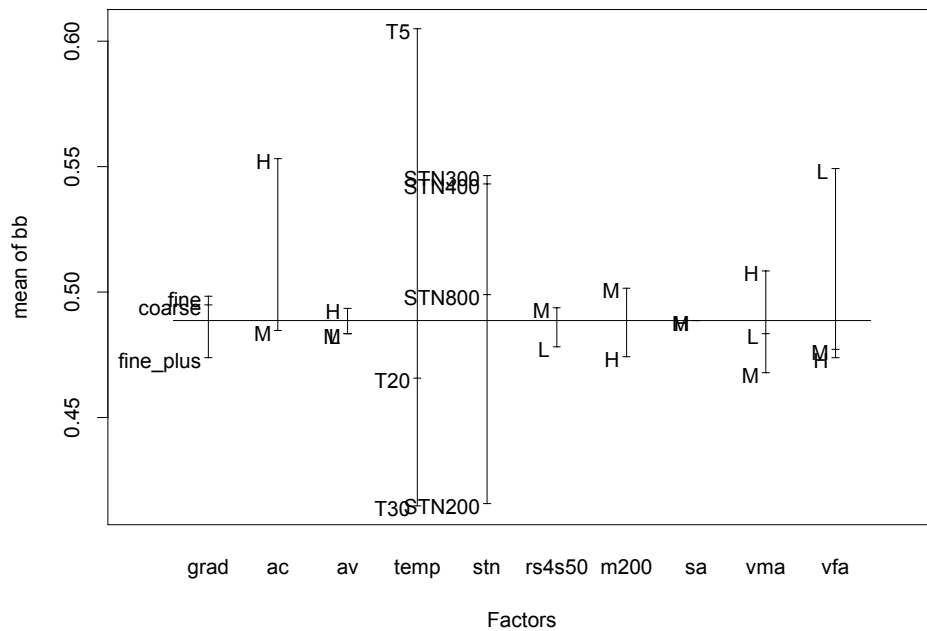

Figure B.4.4. Design plot of *bb* (temperature susceptibility fatigue test, field-mixed and field-compacted).

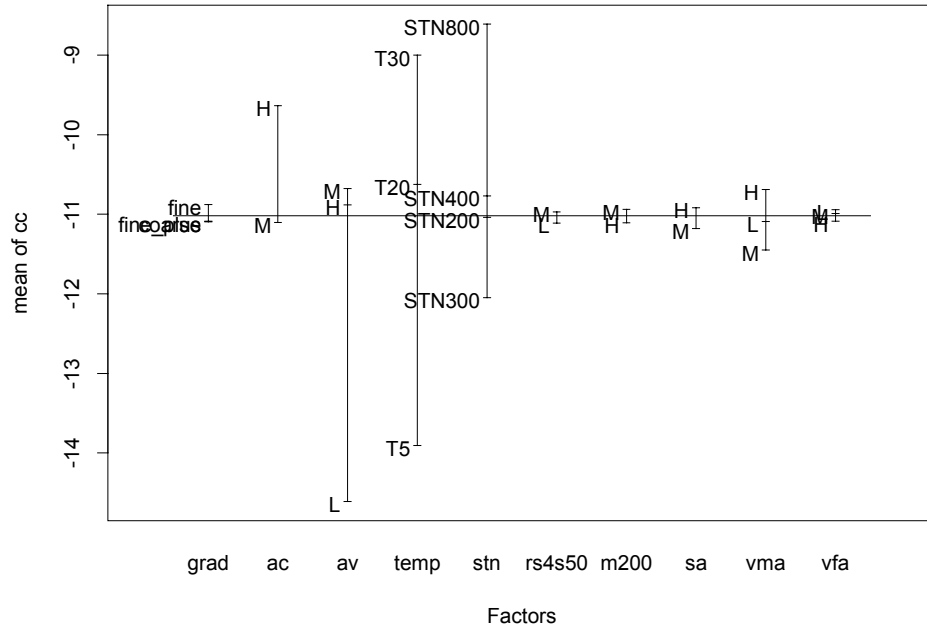

Figure B.4.5. Design plot of *cc* (temperature susceptibility fatigue test, field-mixed and field-compacted).

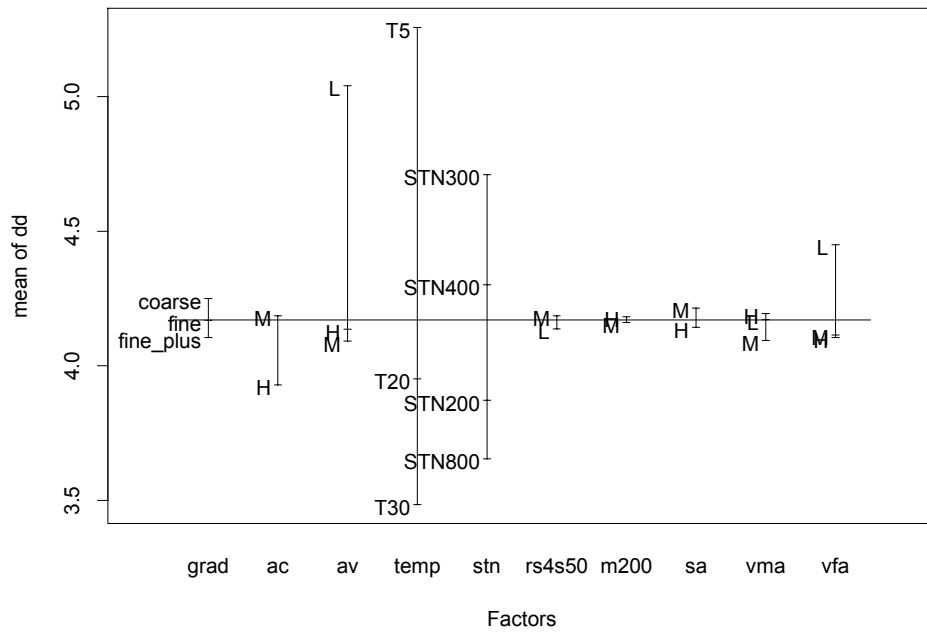

Figure B.4.6. Design plot of *dd* (temperature susceptibility fatigue test, field-mixed and field-compacted).

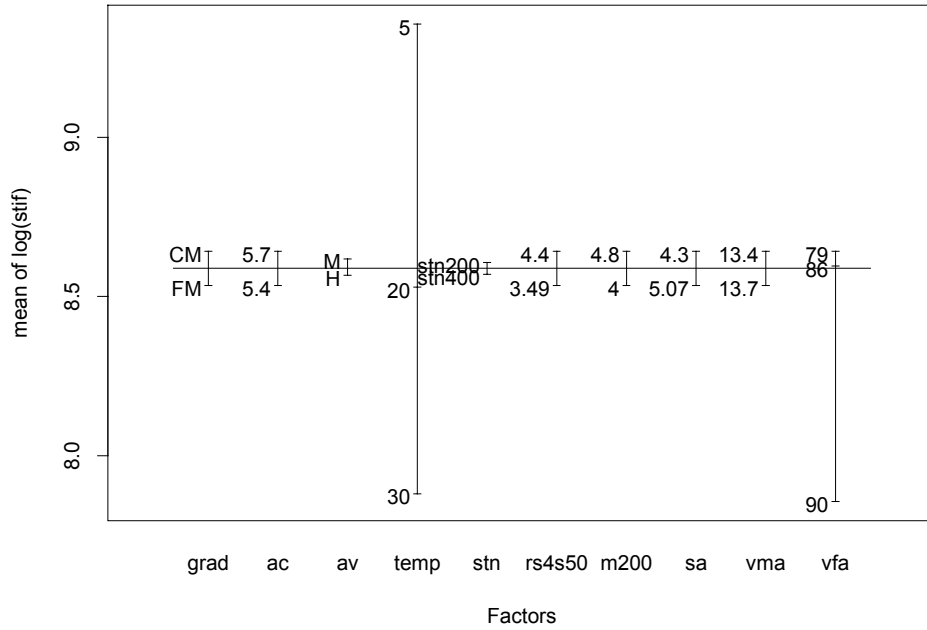

Figure B.4.7. Design plot of $lnstif$ (temperature susceptibility fatigue test, lab.-mixed and lab.-compacted).

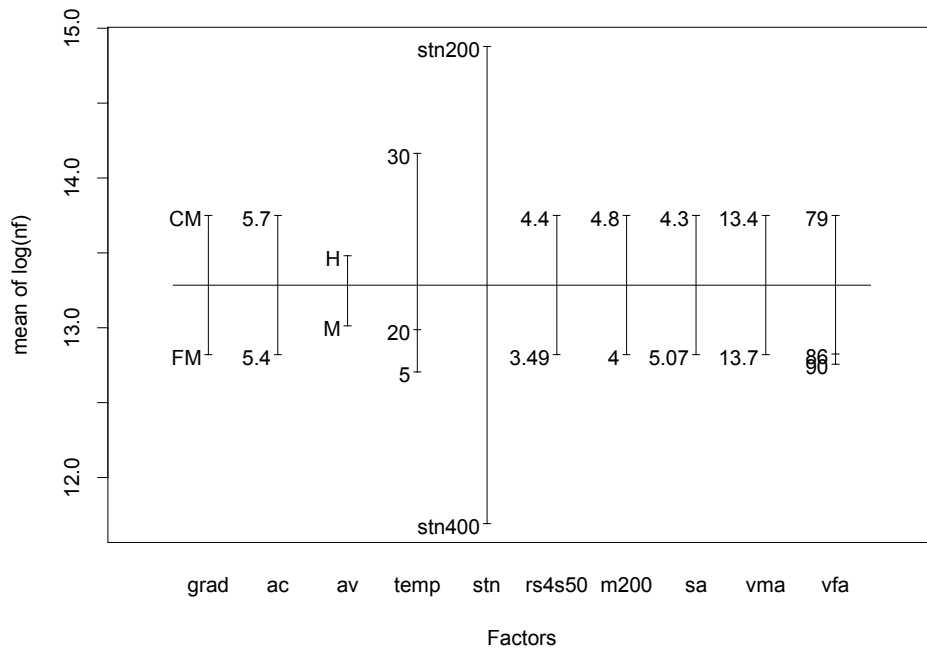

Figure B.4.8. Design plot of $lnnf$ (temperature susceptibility fatigue test, lab.-mixed and lab.-compacted).

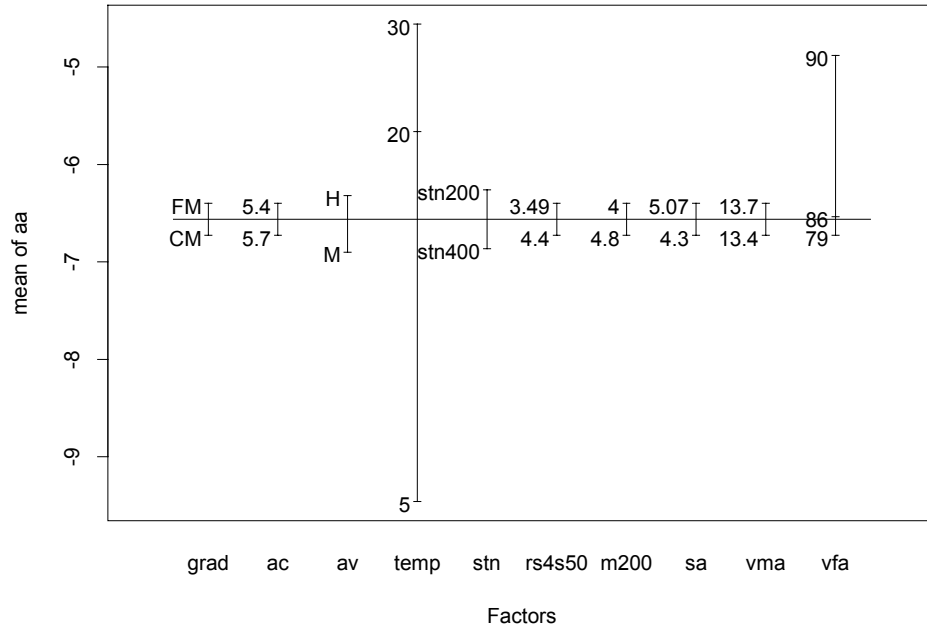

Figure B.4.9. Design plot of *aa* (temperature susceptibility fatigue test, lab.-mixed and lab.-compacted).

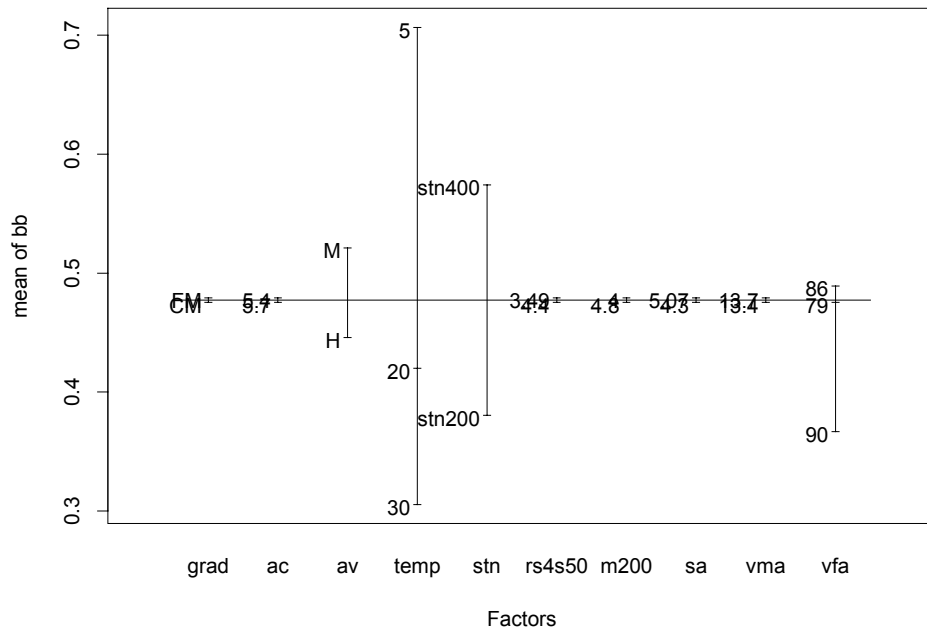

Figure B.4.10. Design plot of *bb* (temperature susceptibility fatigue test, lab.-mixed and lab.-compacted).

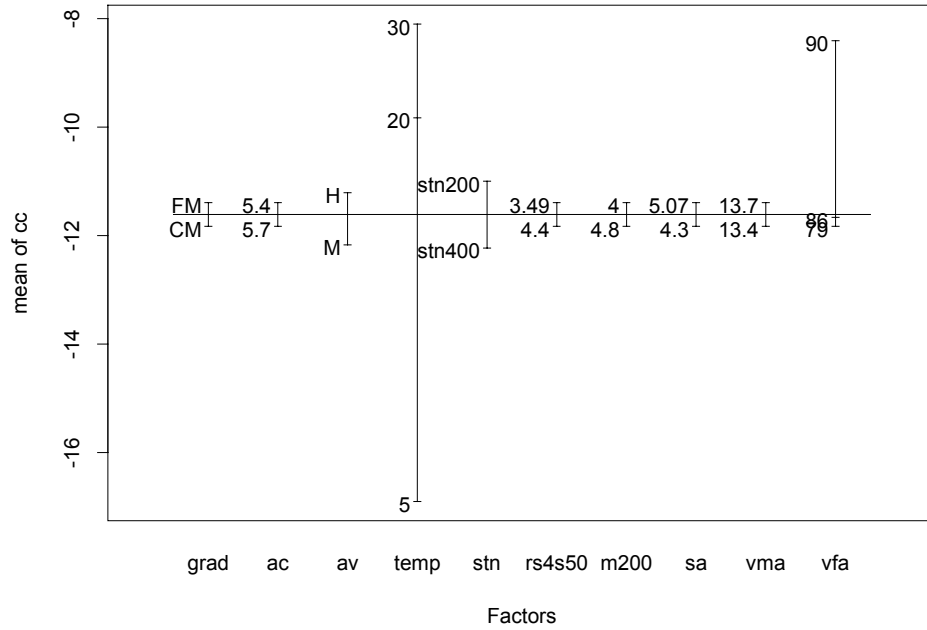

Figure B.4.11. Design plot of *cc* (temperature susceptibility fatigue test, lab.-mixed and lab.-compacted).

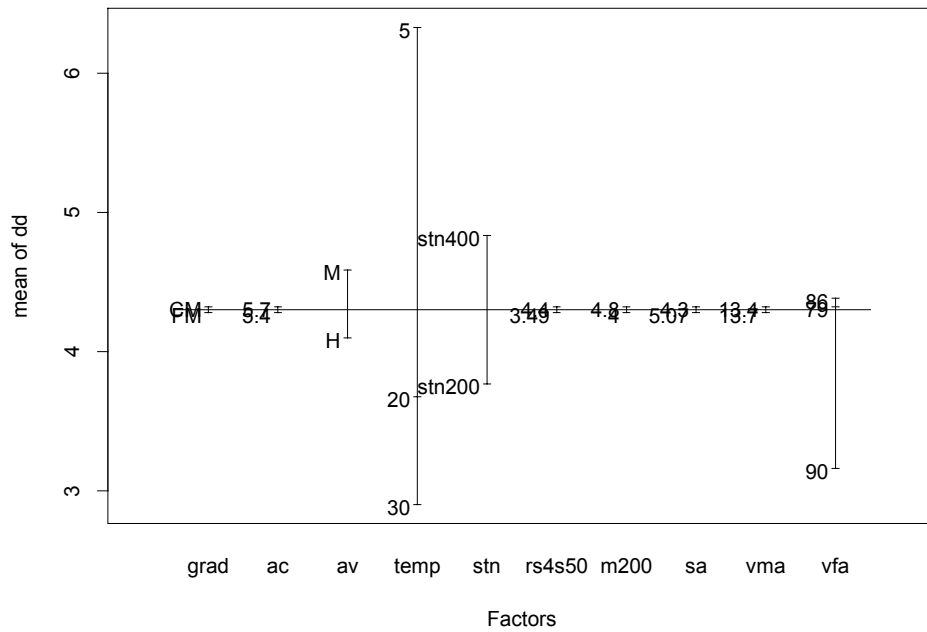

Figure B.4.12. Design plot of *dd* (temperature susceptibility fatigue test, lab.-mixed and lab.-compacted).

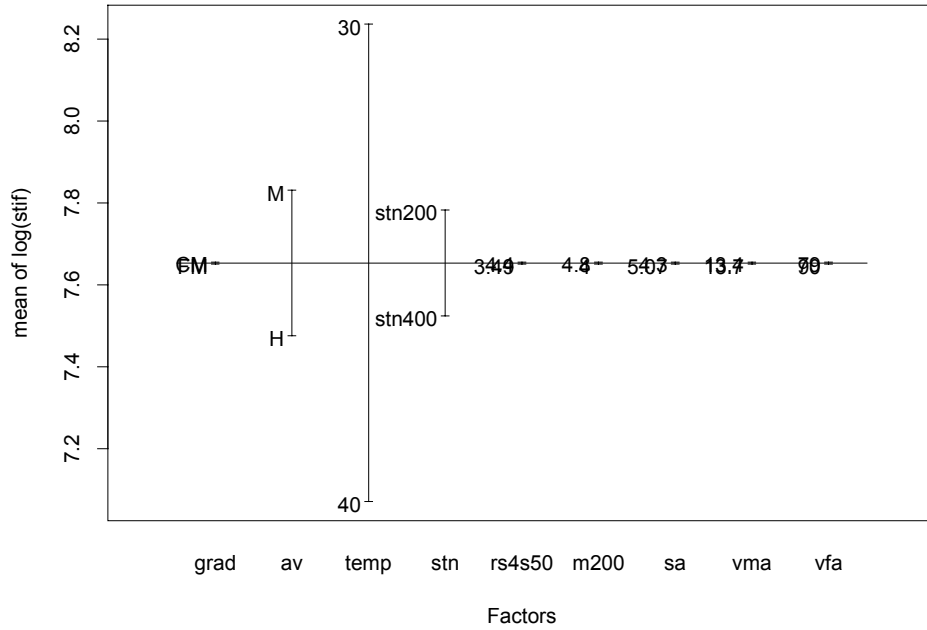

Figure B.4.13. Design plot of *lnstif* (high temperature fatigue test).

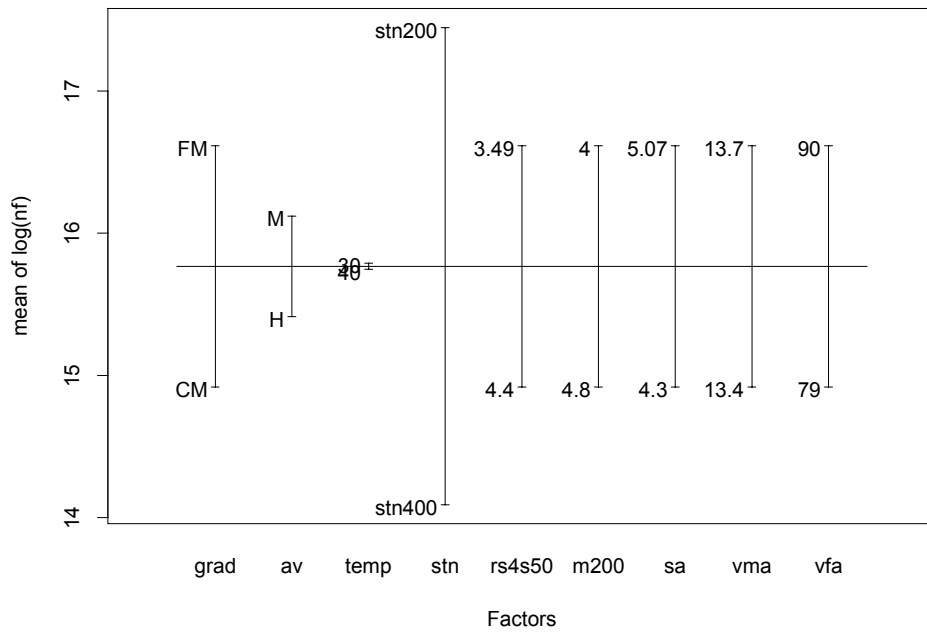

Figure B.4.14. Design plot of *lnnf* (high temperature fatigue test).

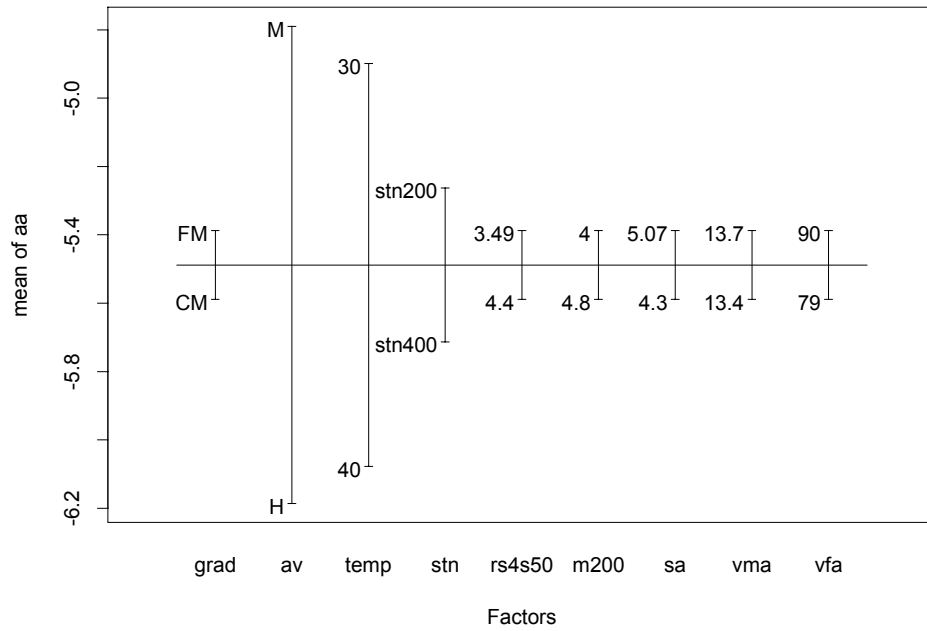

Figure B.4.15. Design plot of *aa* (high temperature fatigue test).

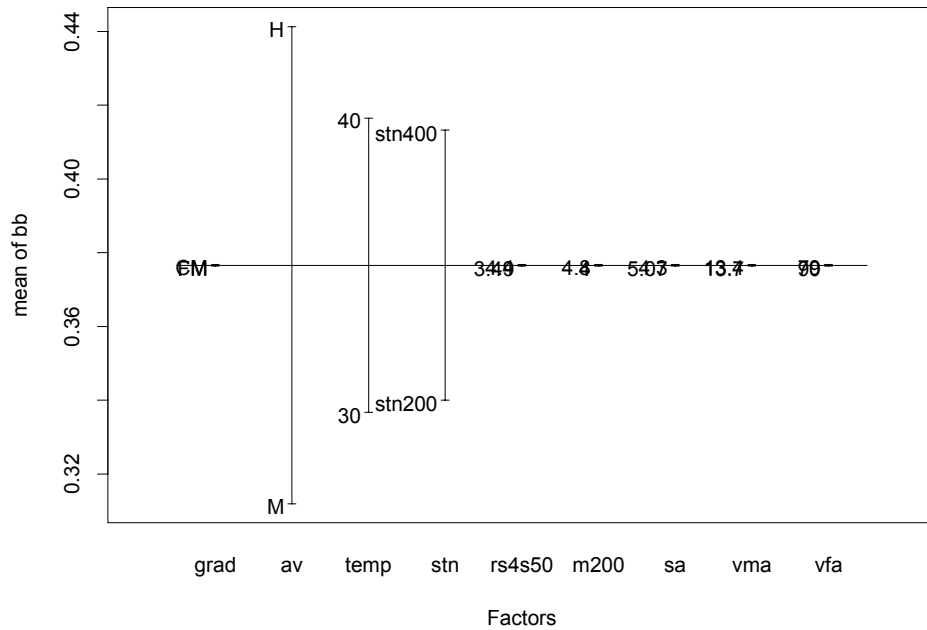

Figure B.4.16. Design plot of *bb* (high temperature fatigue test).

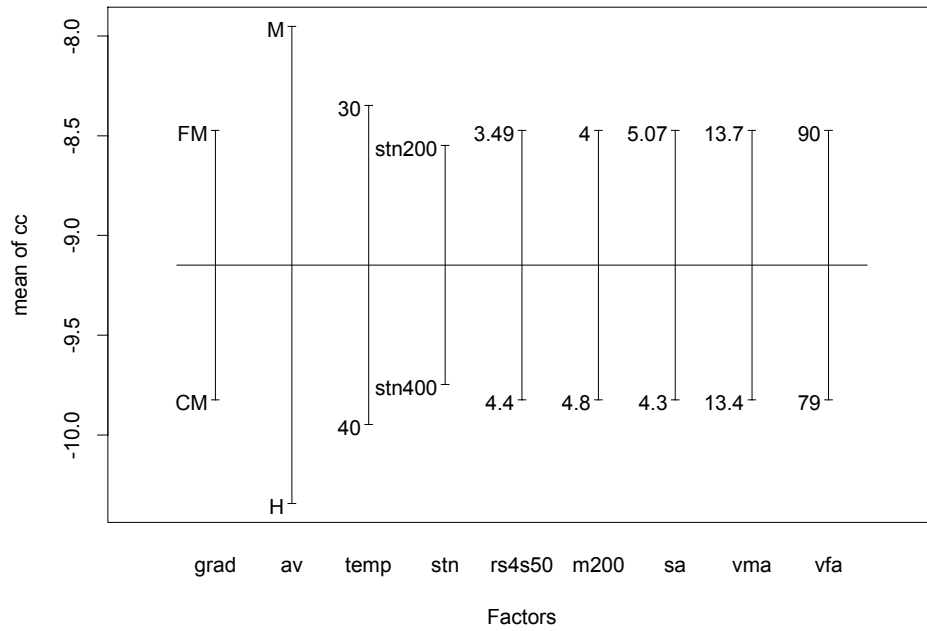

Figure B.4.17. Design plot of *cc* (high temperature fatigue test).

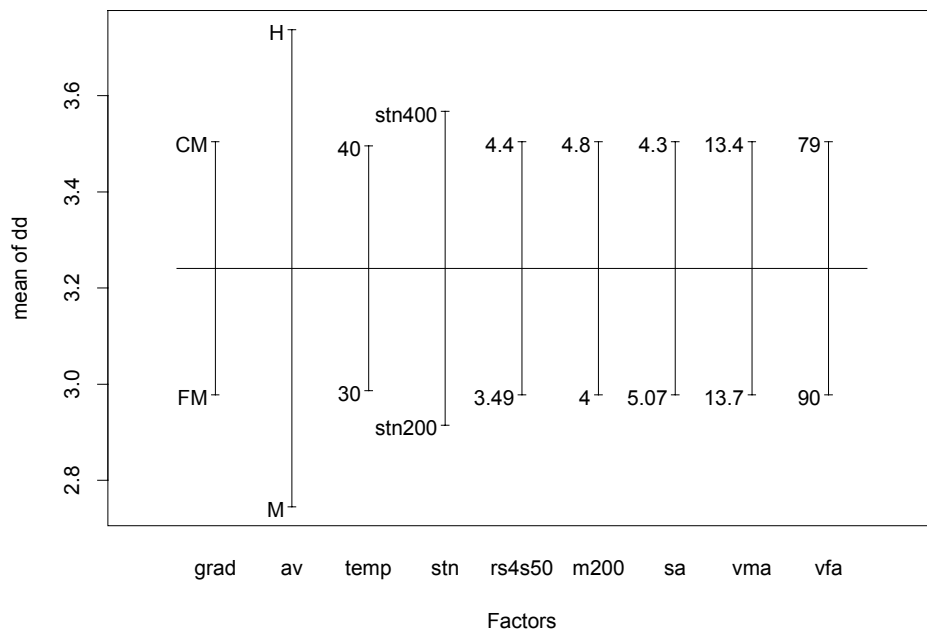

Figure B.4.18. Design plot of *dd* (high temperature fatigue test).

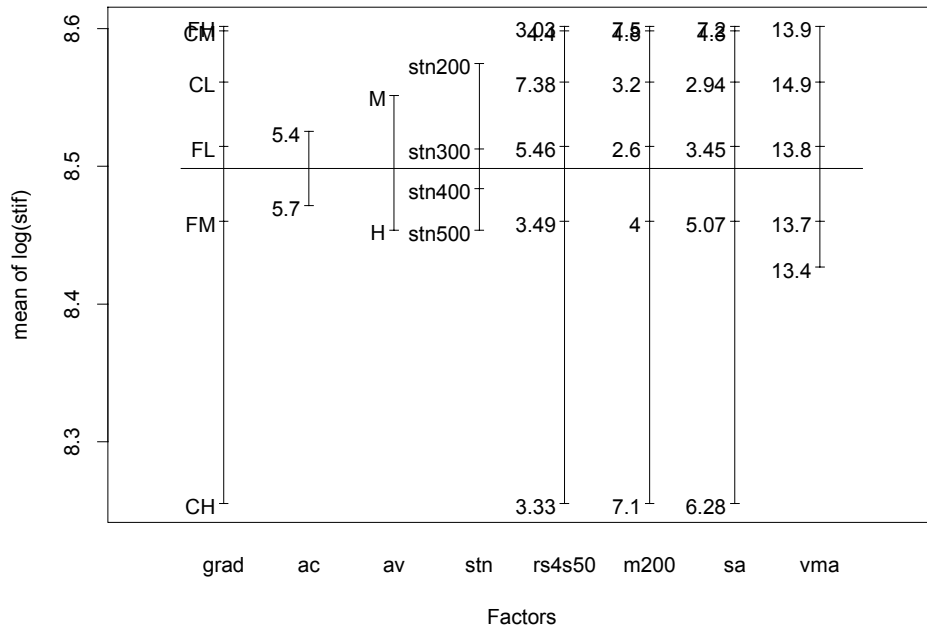

Figure B.4.19. Design plot of *lnstif* (fatigue test with various gradations at 20°C).

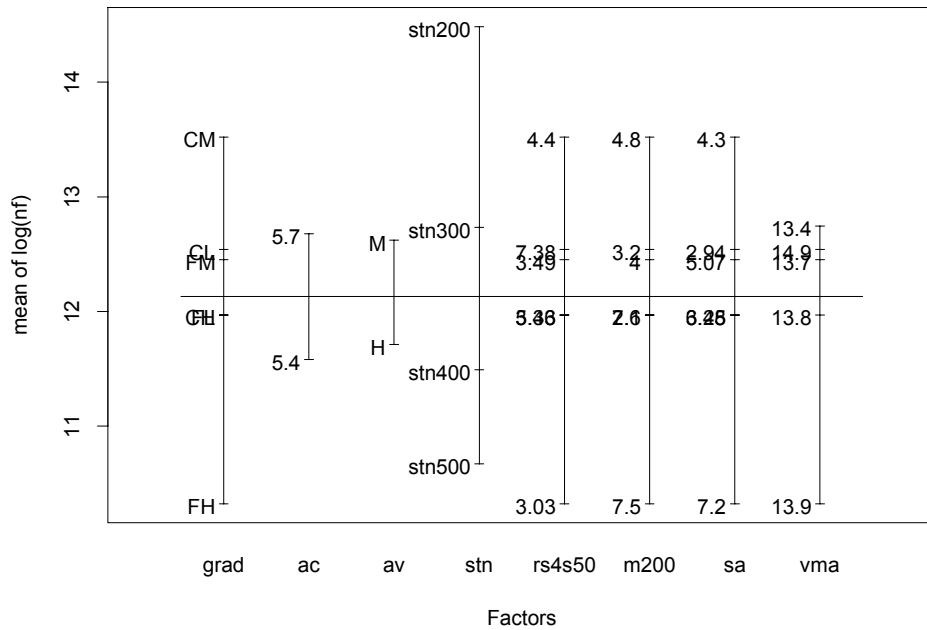

Figure B.4.20. Design plot of *lnlnf* (fatigue test with various gradations at 20°C).

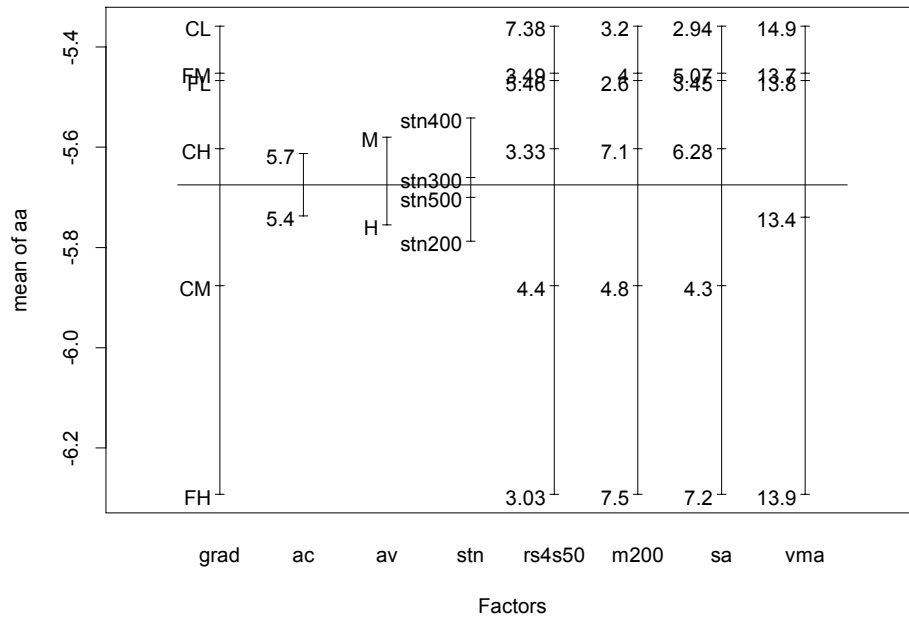

Figure B.4.21. Design plot of *aa* (fatigue test with various gradations at 20°C).

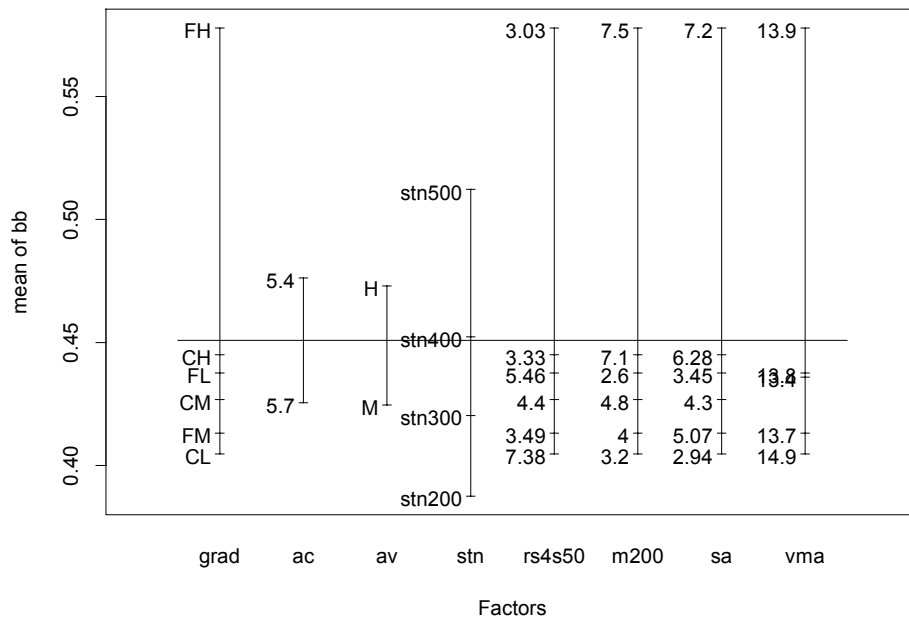

Figure B.4.22. Design plot of *bb* (fatigue test with various gradations at 20°C).

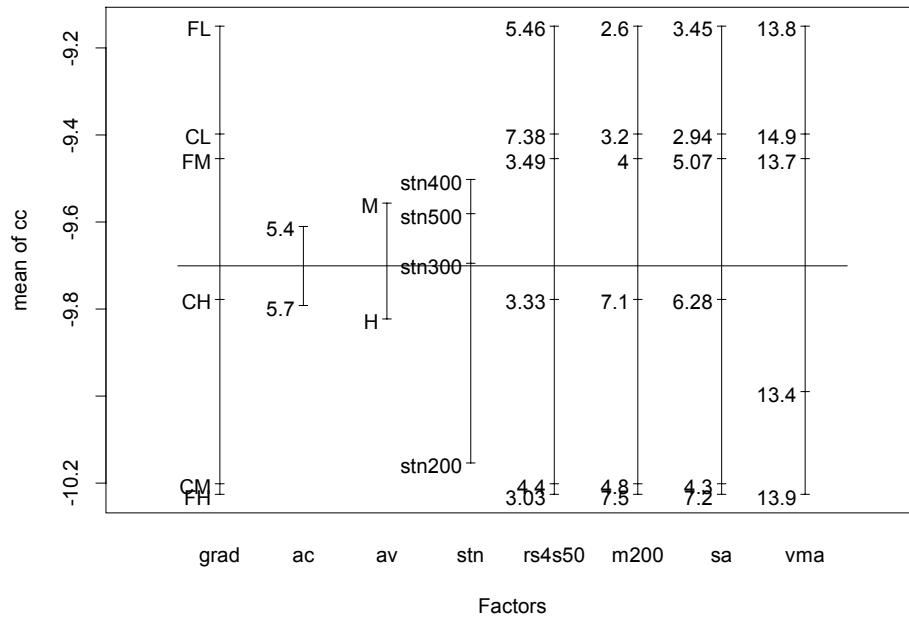

Figure B.4.23. Design plot of *cc* (fatigue test with various gradations at 20°C).

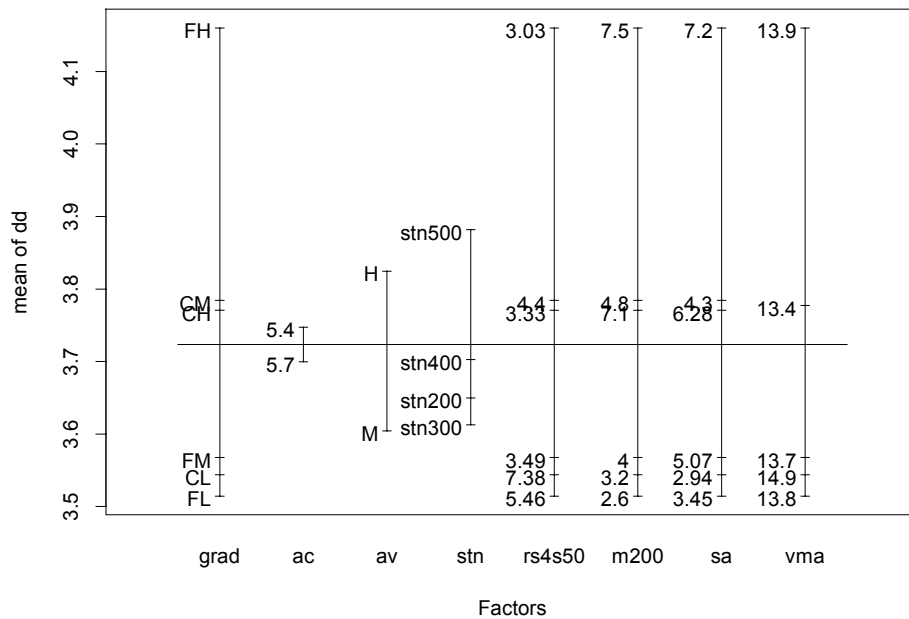

Figure B.4.24. Design plot of *dd* (fatigue test with various gradations at 20°C).

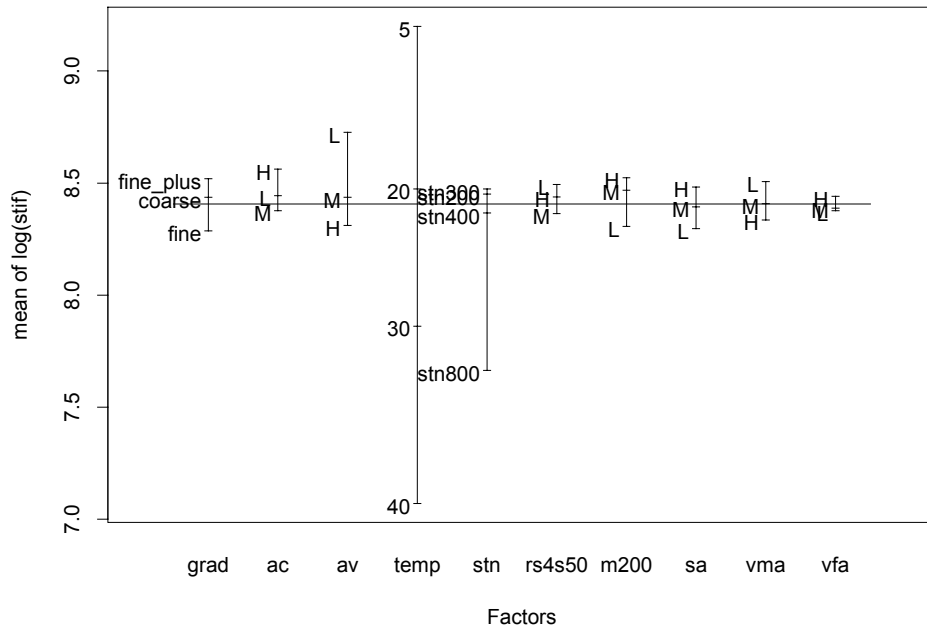

Figure B.4.25. Design plot of $\ln stif$ (pooled fatigue tests).

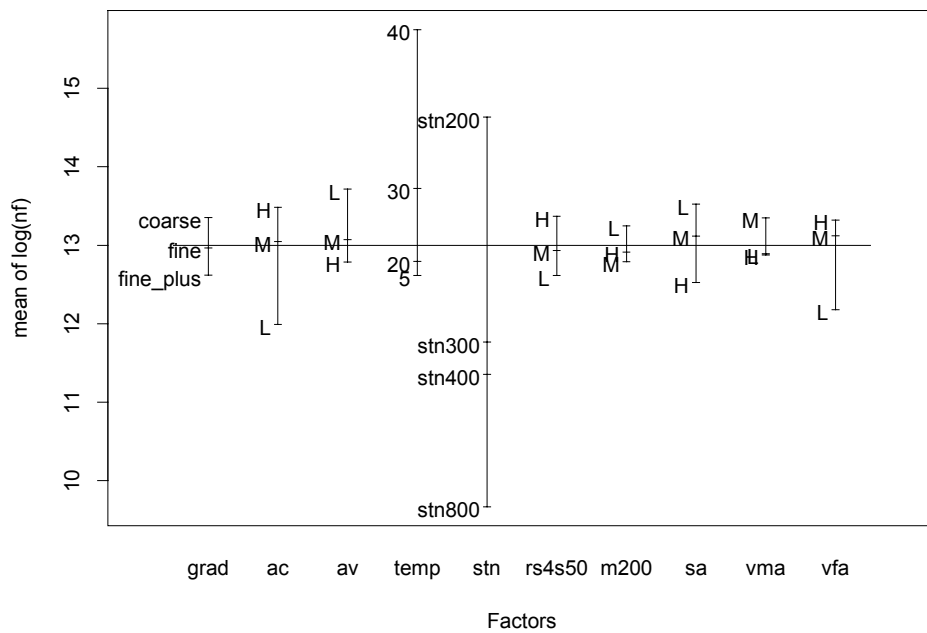

Figure B.4.26. Design plot of $\ln nf$ (pooled fatigue tests).

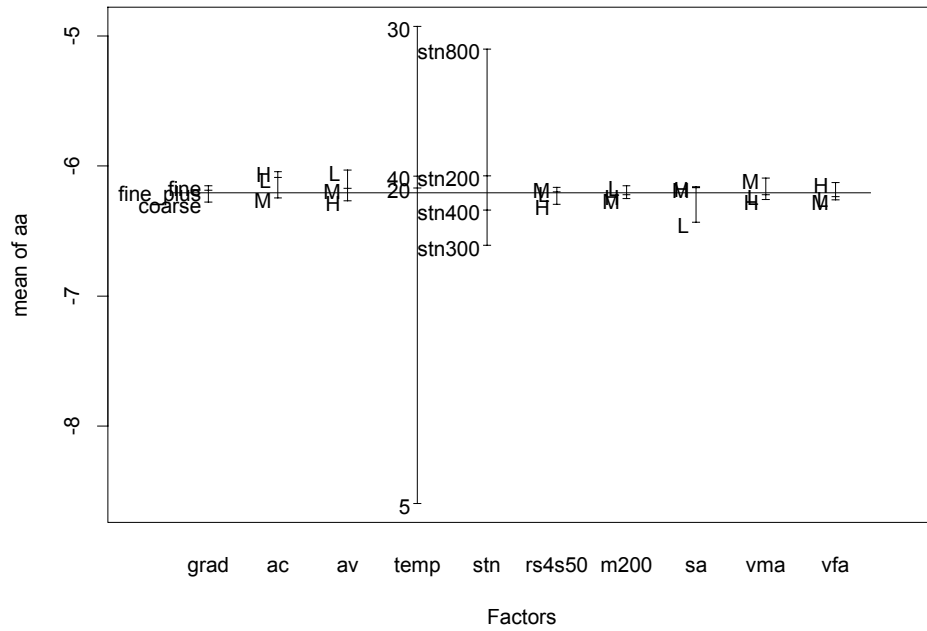

Figure B.4.27. Design plot of *aa* (pooled fatigue tests).

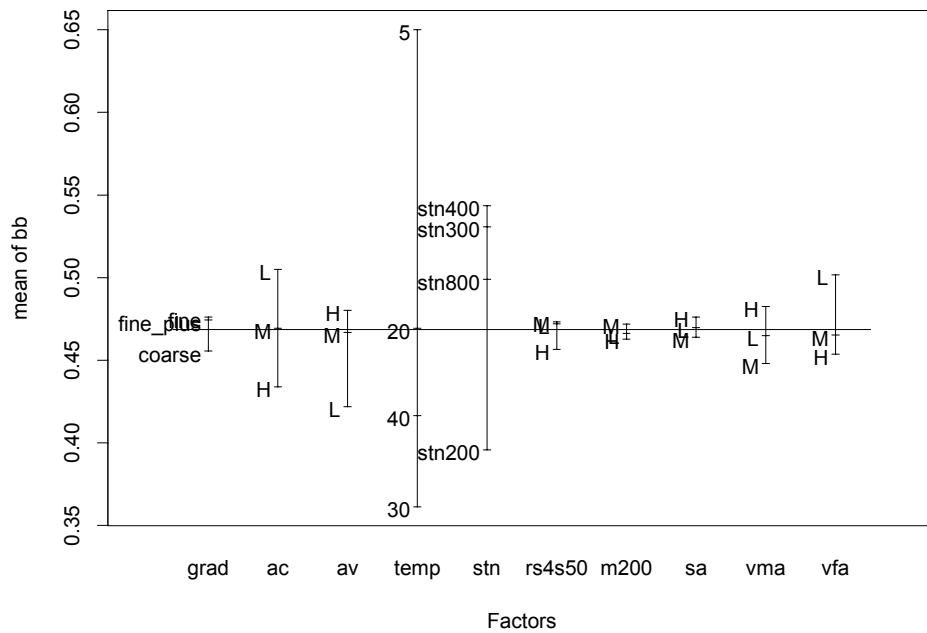

Figure B.4.28. Design plot of *bb* (pooled fatigue tests).

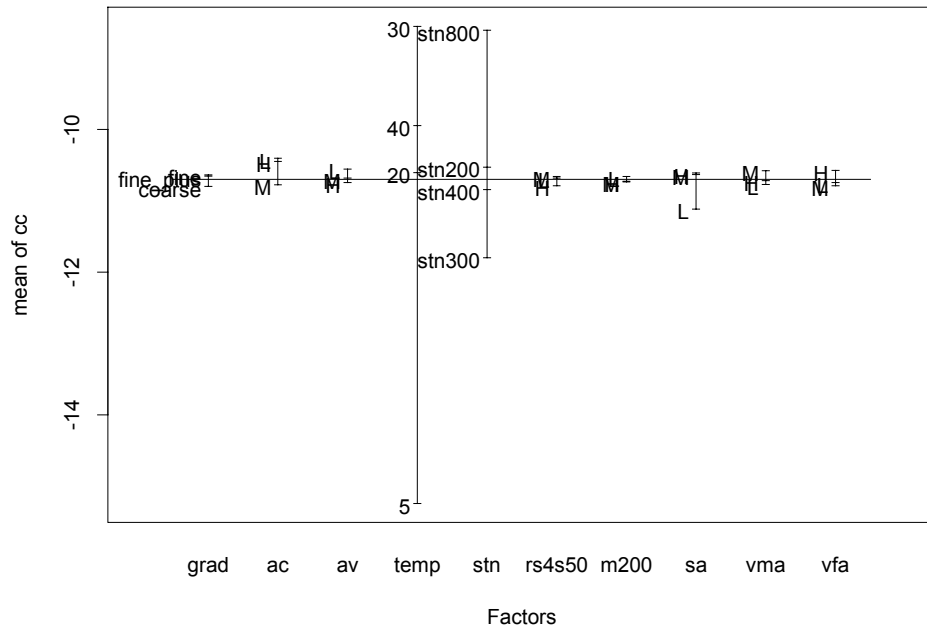

Figure B.4.29. Design plot of *cc* (pooled fatigue tests).

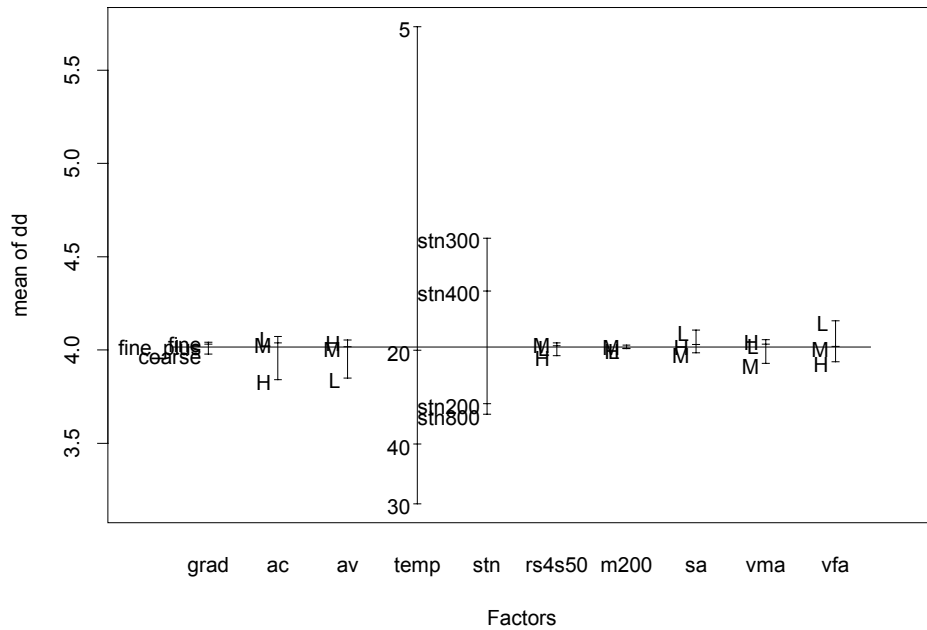

Figure B.4.30. Design plot of *dd* (pooled fatigue tests).

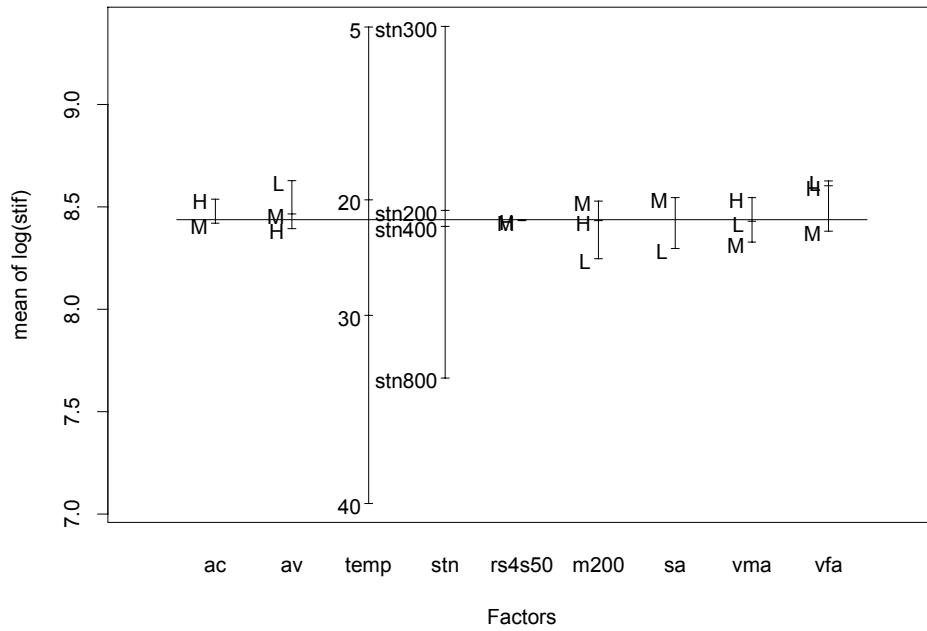

Figure B.4.31. Design plot of *lnstif* (regression: coarse).

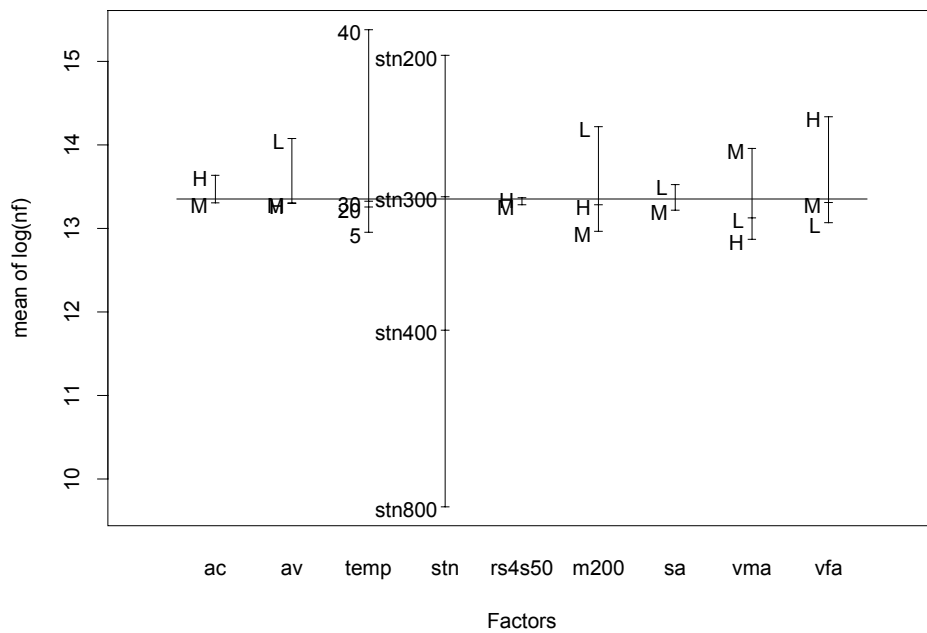

Figure B.4.32. Design plot of *lnnf* (regression: coarse).

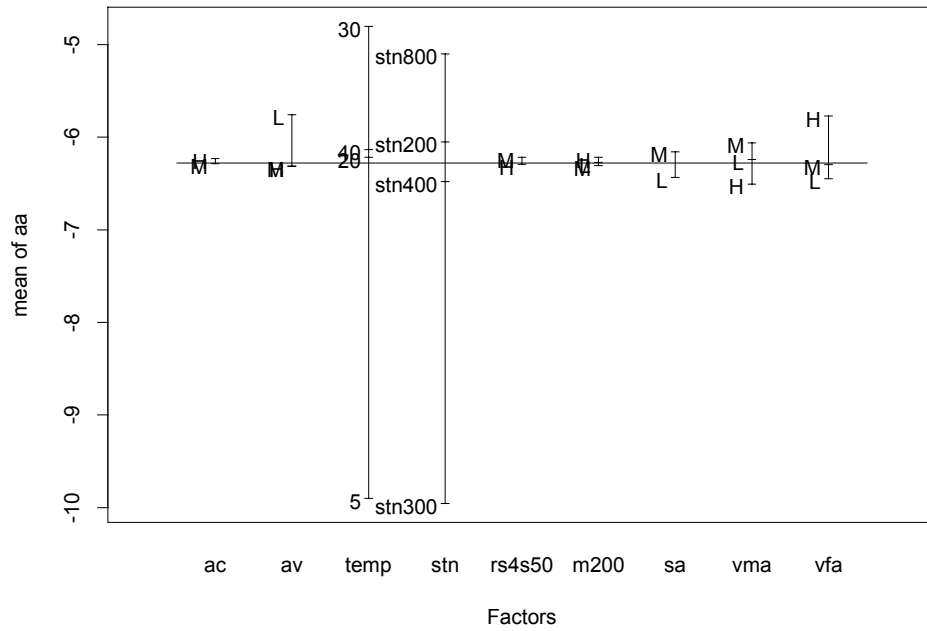

Figure B.4.33. Design plot of *aa* (regression: coarse).

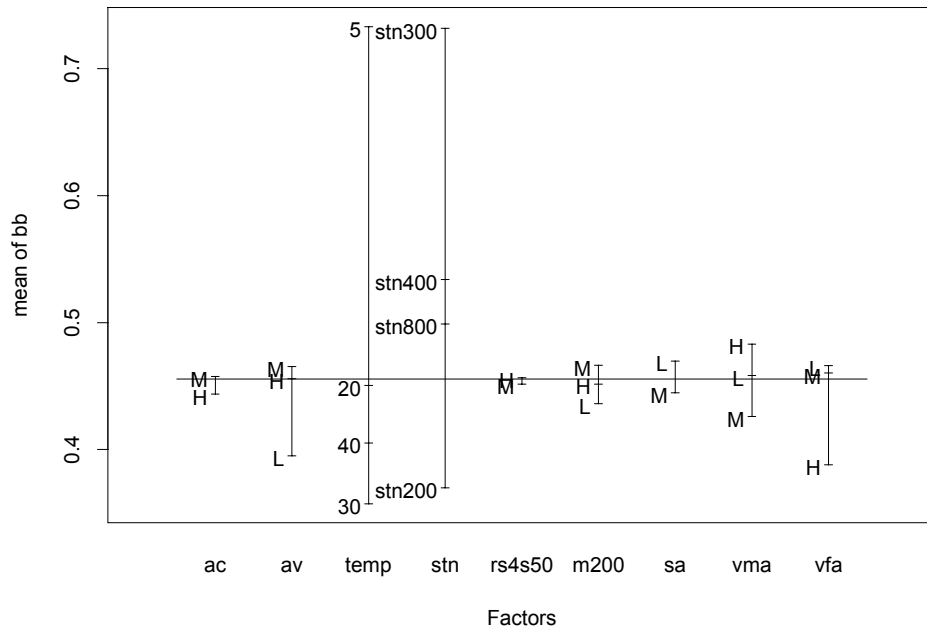

Figure B.4.34. Design plot of *bb* (regression: coarse).

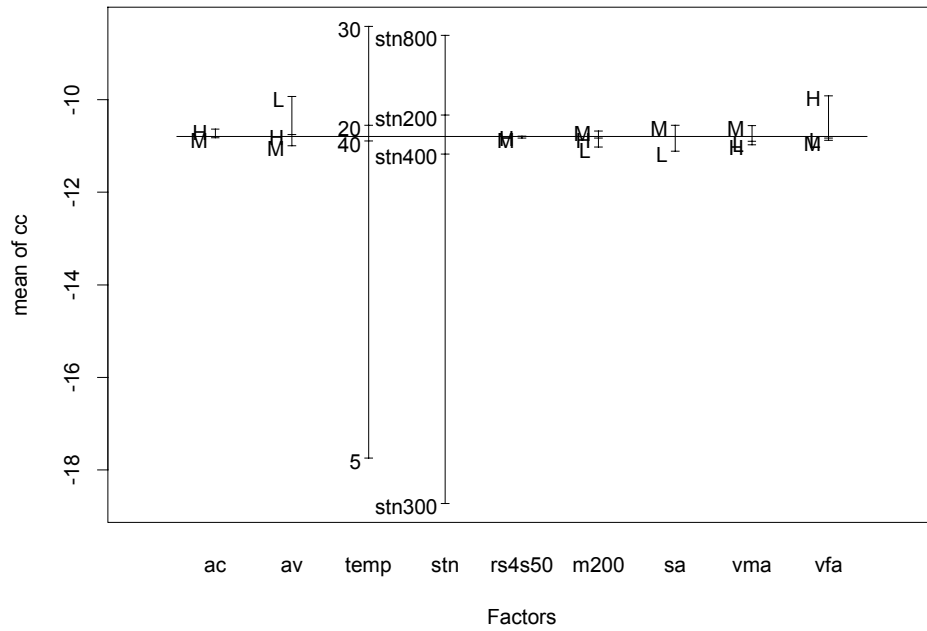

Figure B.4.35. Design plot of *cc* (regression: coarse).

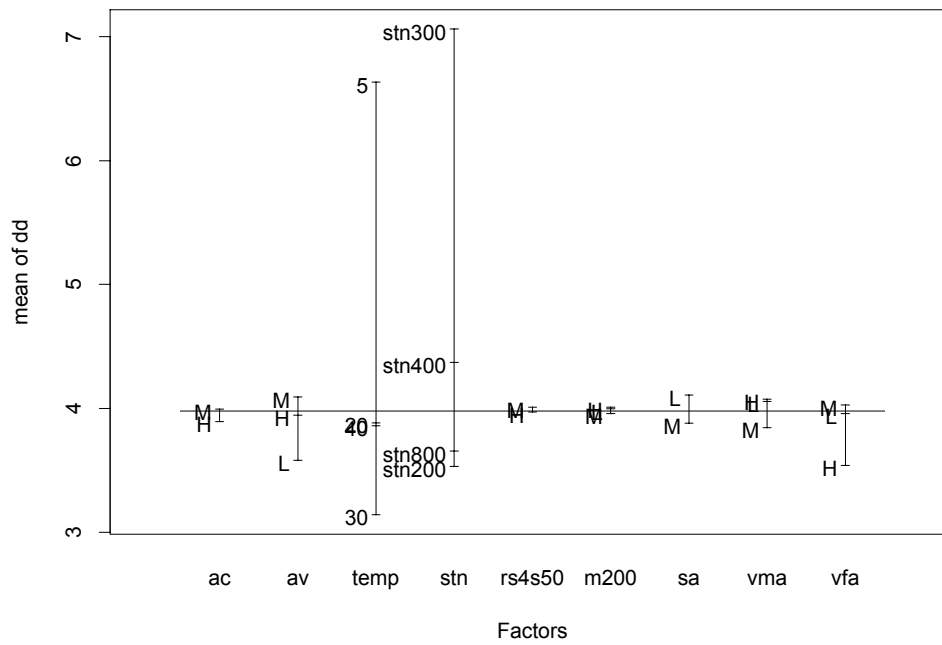

Figure B.4.36. Design plot of *dd* (regression: coarse).

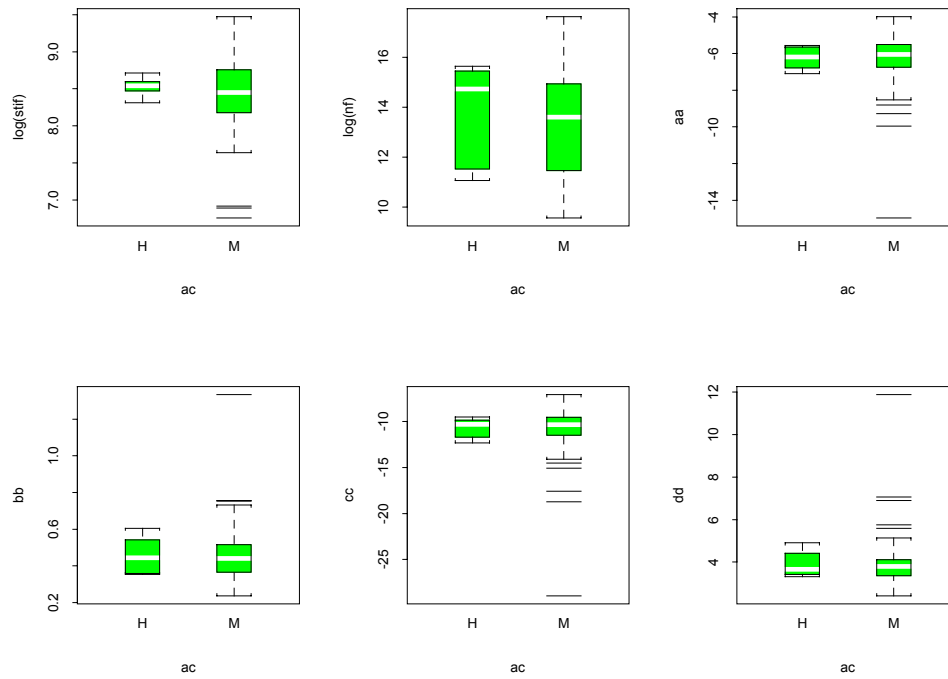

Figure B.4.37. Boxplots for factor ac (regression: coarse).

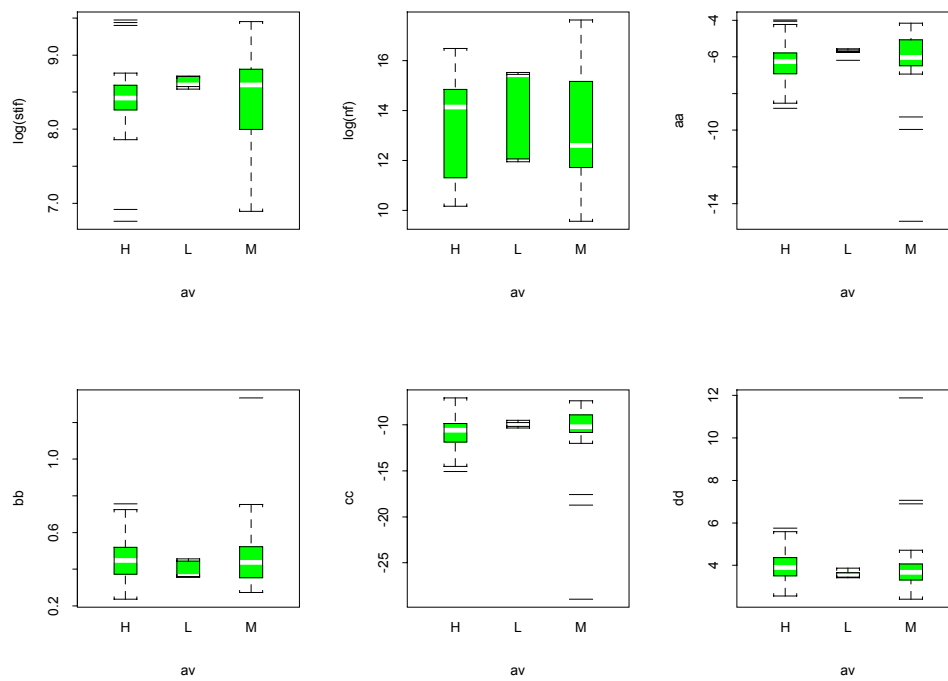

Figure B.4.38. Boxplots for factor av (regression: coarse).

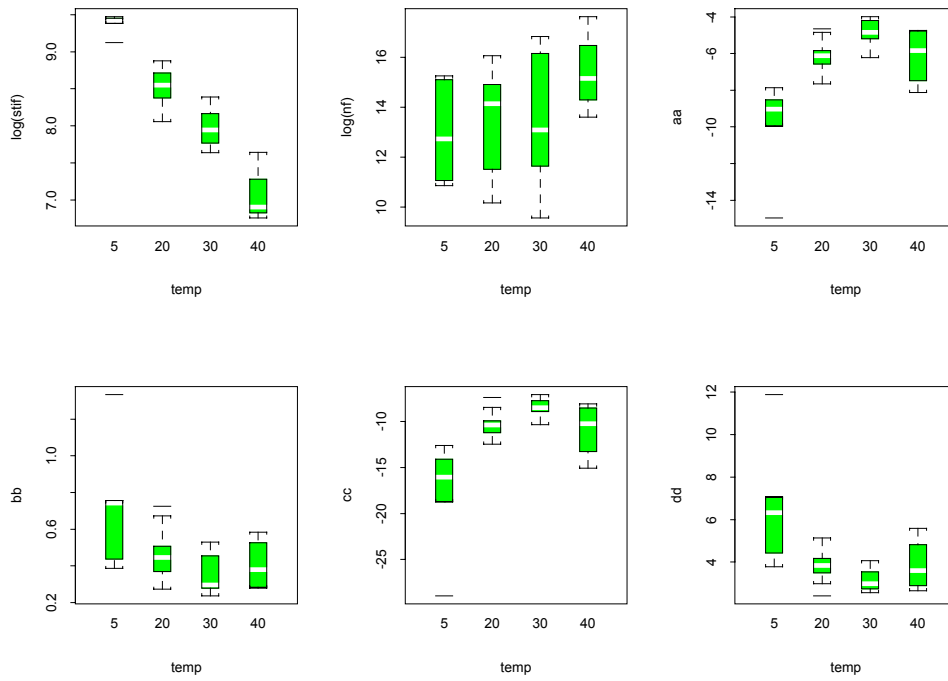

Figure B.4.39. Boxplots for factor *temp* (regression: coarse).

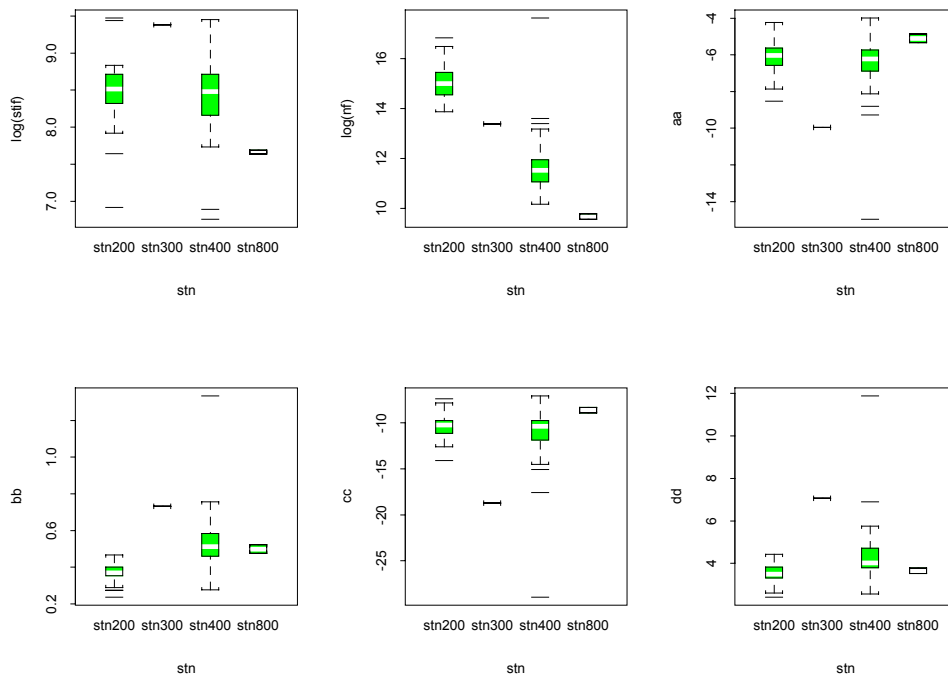

Figure B.4.40. Boxplots for factor *stn* (regression: coarse).

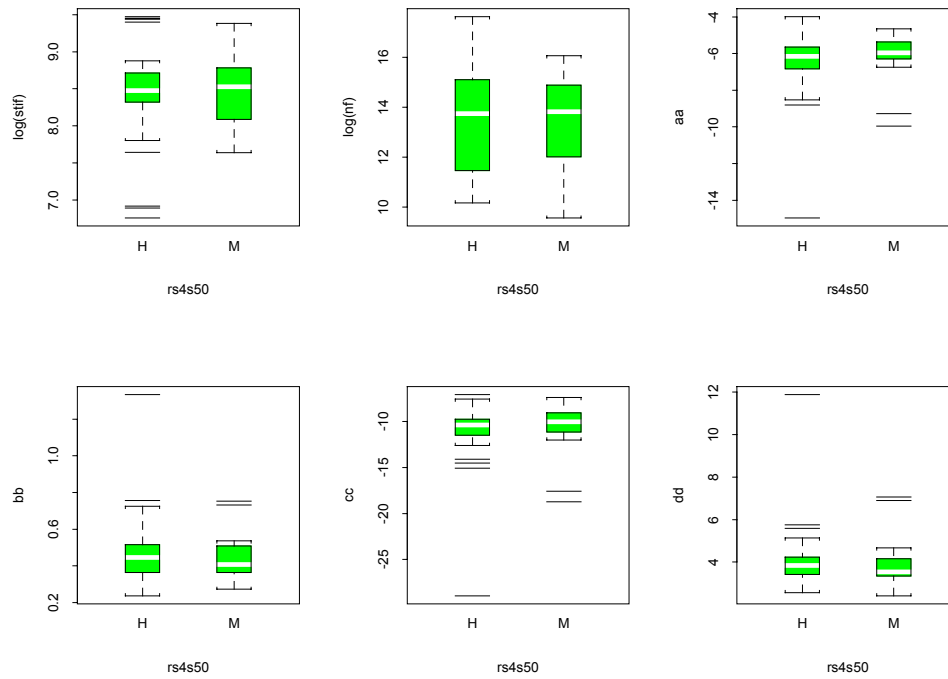

Figure B.4.41. Boxplots for factor *rs4s50* (regression: coarse).

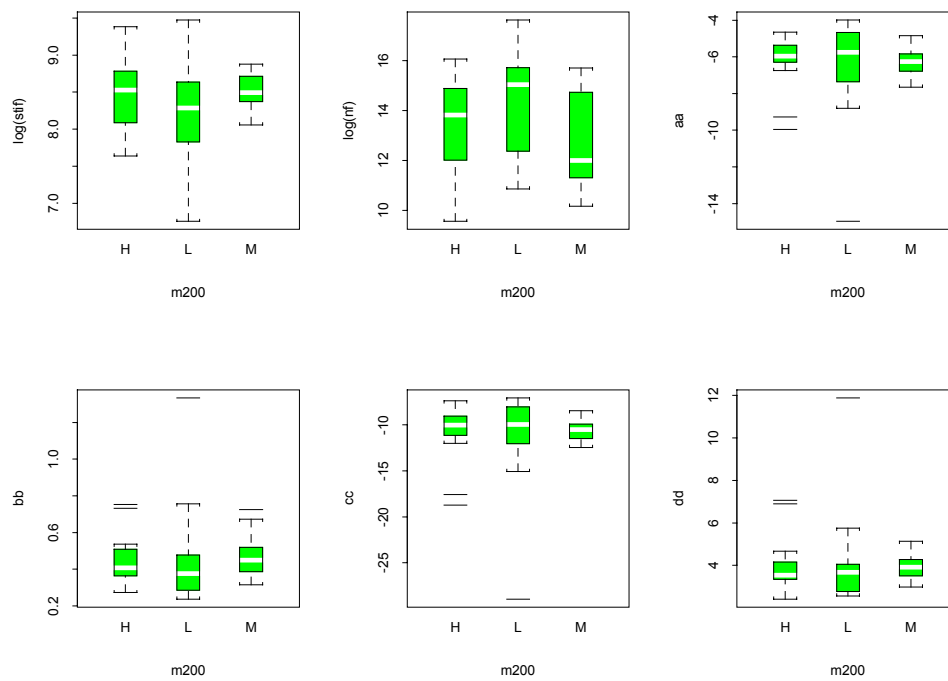

Figure B.4.42. Boxplots for factor *m200* (regression: coarse).

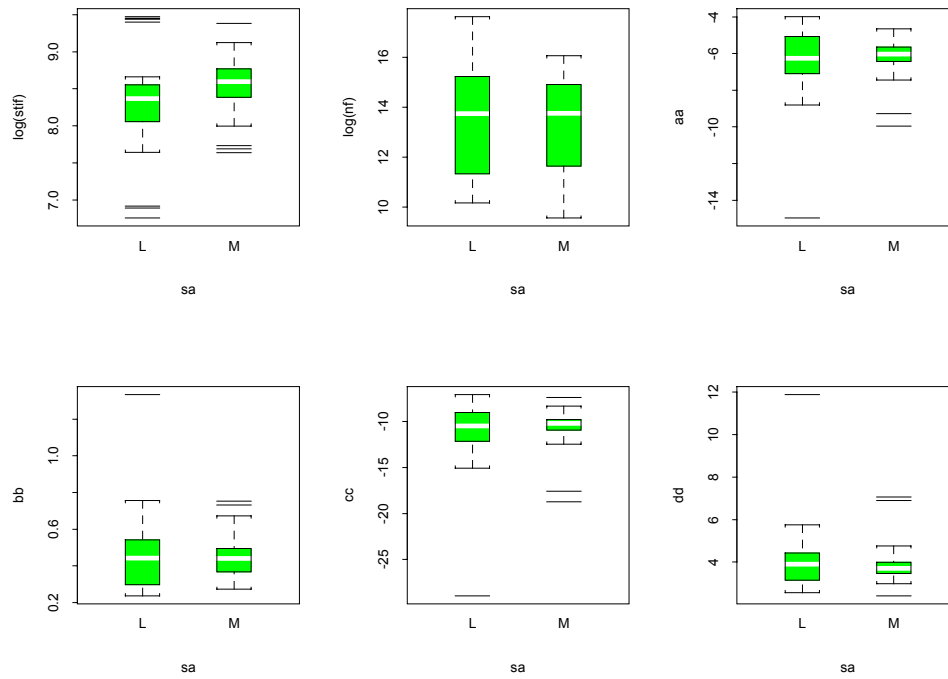

Figure B.4.43. Boxplots for factor sa (regression: coarse).

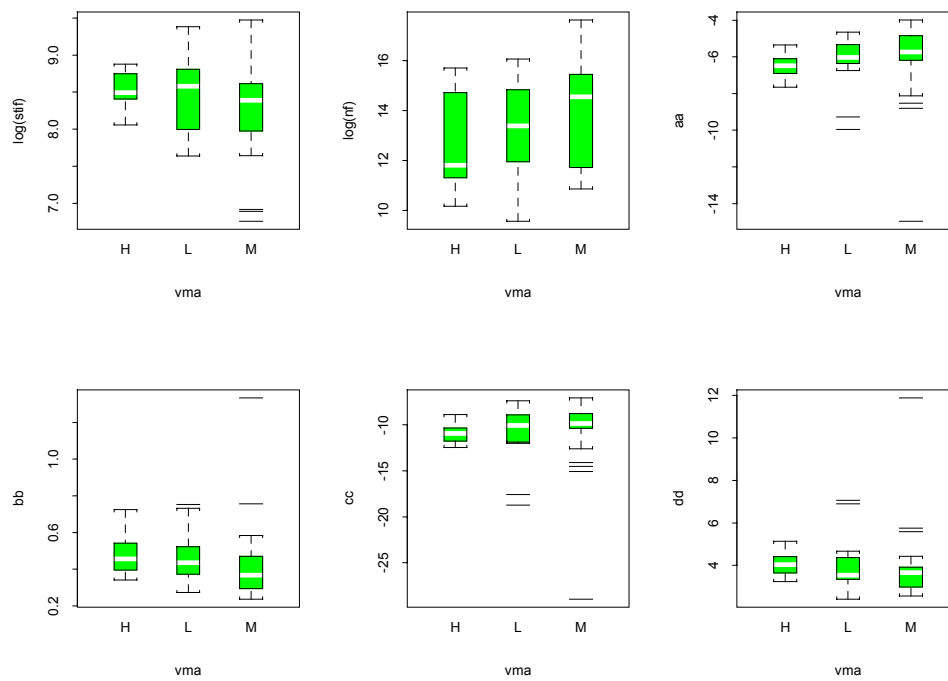

Figure B.4.44. Boxplots for factor vma (regression: coarse).

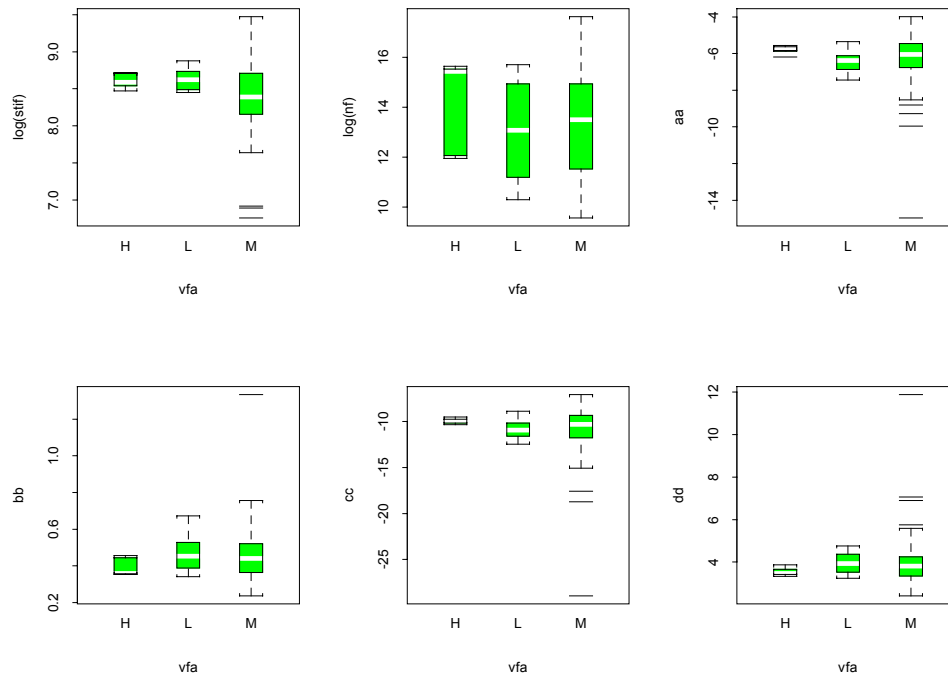

Figure B.4.45. Boxplots for factor *vfa* (regression: coarse).

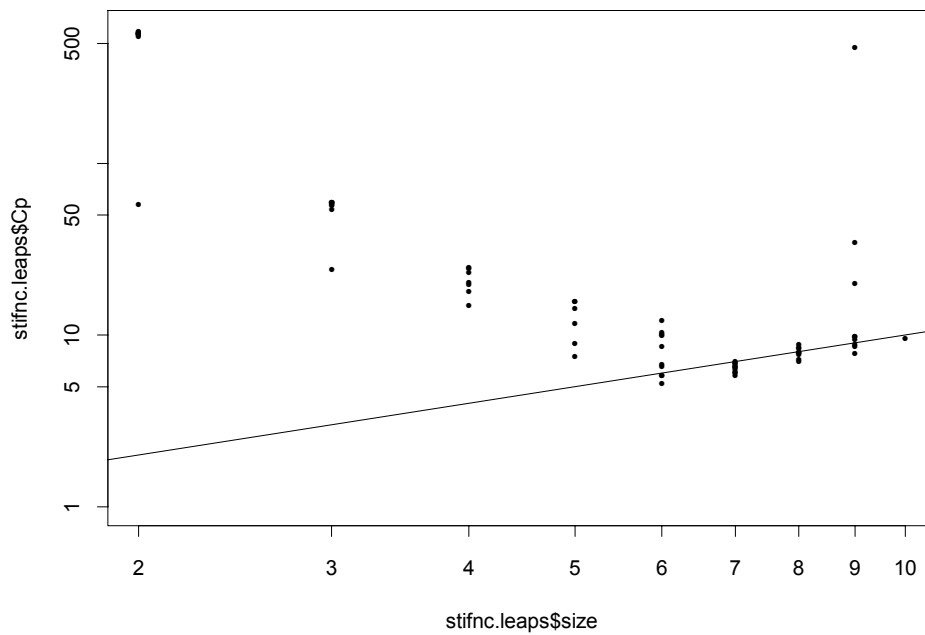

Figure B.4.46. C_p plot for the model selection of initial stiffness (coarse).

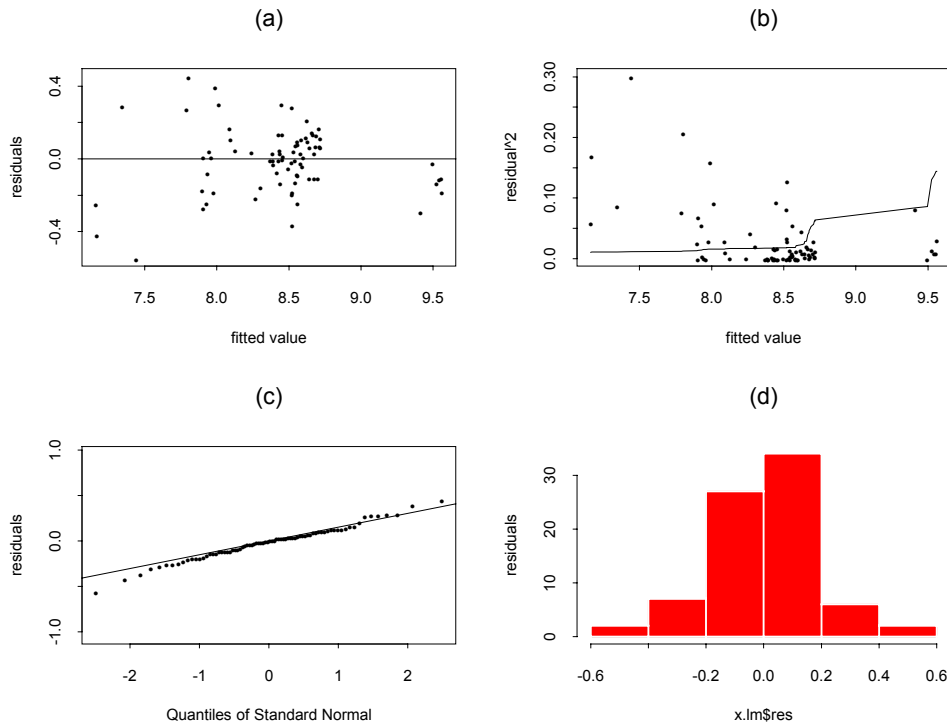

Figure B.4.47. Residual plots for the regression model of initial stiffness (coarse).

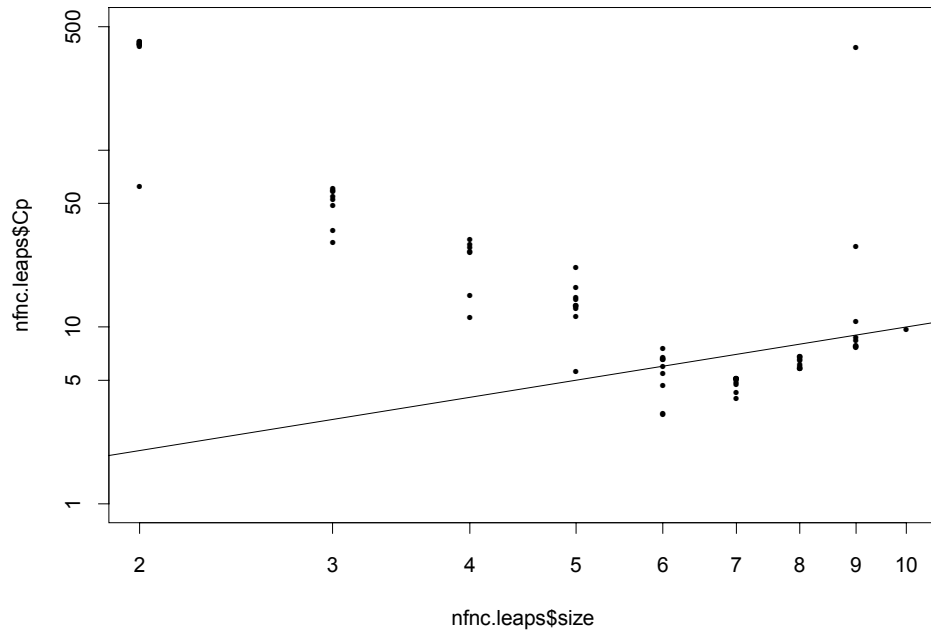

Figure B.4.48. C_p plot for the model selection of fatigue life (coarse).

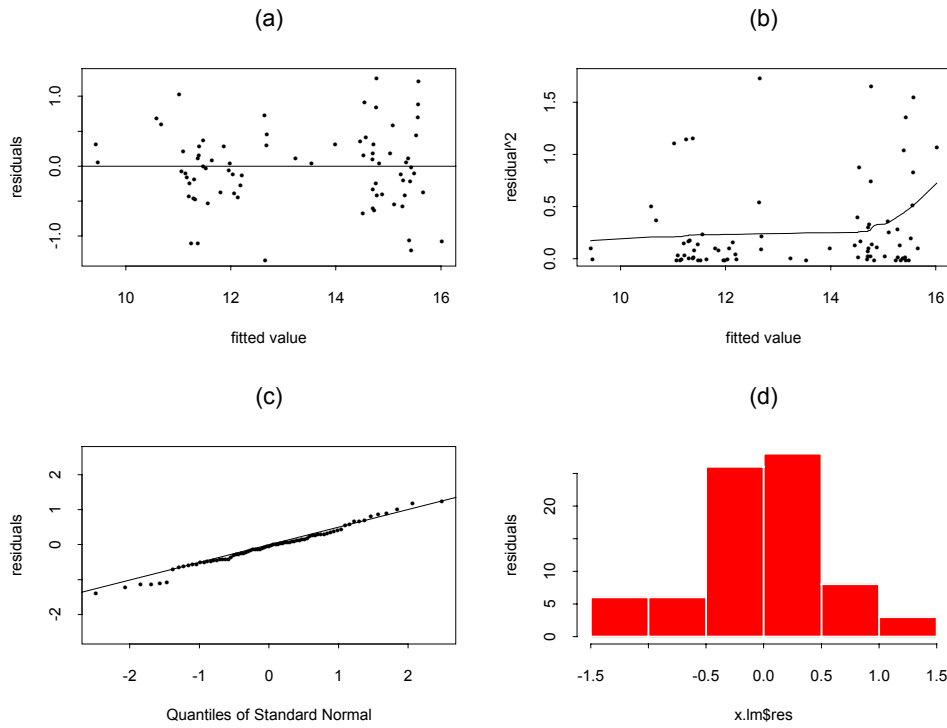

Figure B.4.49. Residual plots for the regression model of fatigue life (coarse).

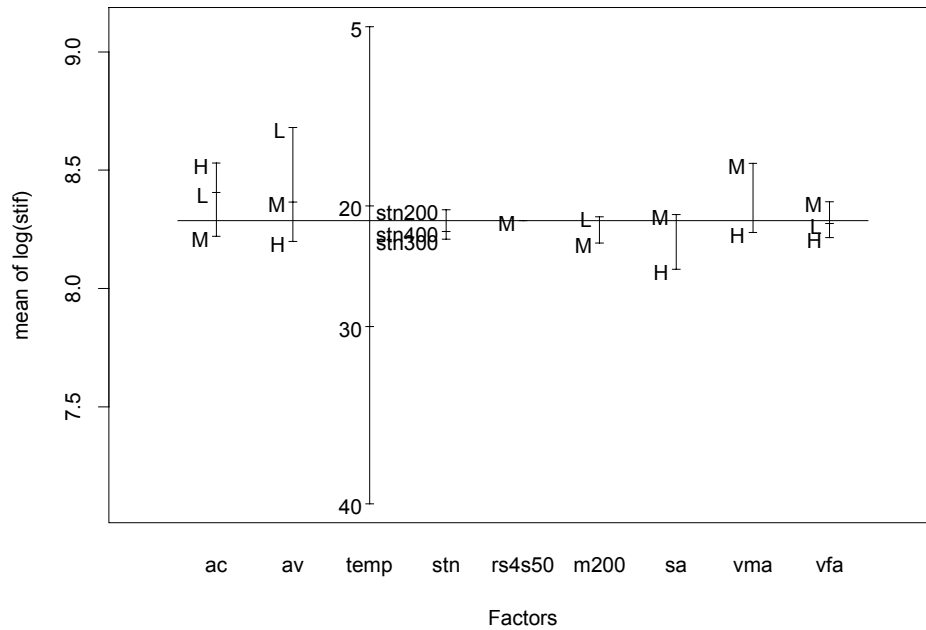

Figure B.4.50. Design plot of *lnstif* (regression: fine).

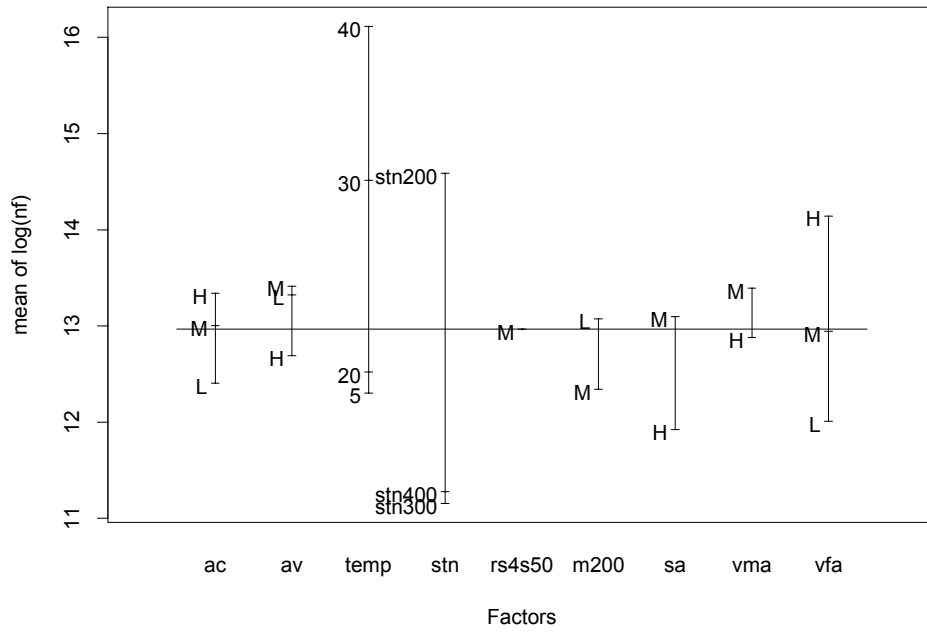

Figure B.4.51. Design plot of *ln nf* (regression: fine).

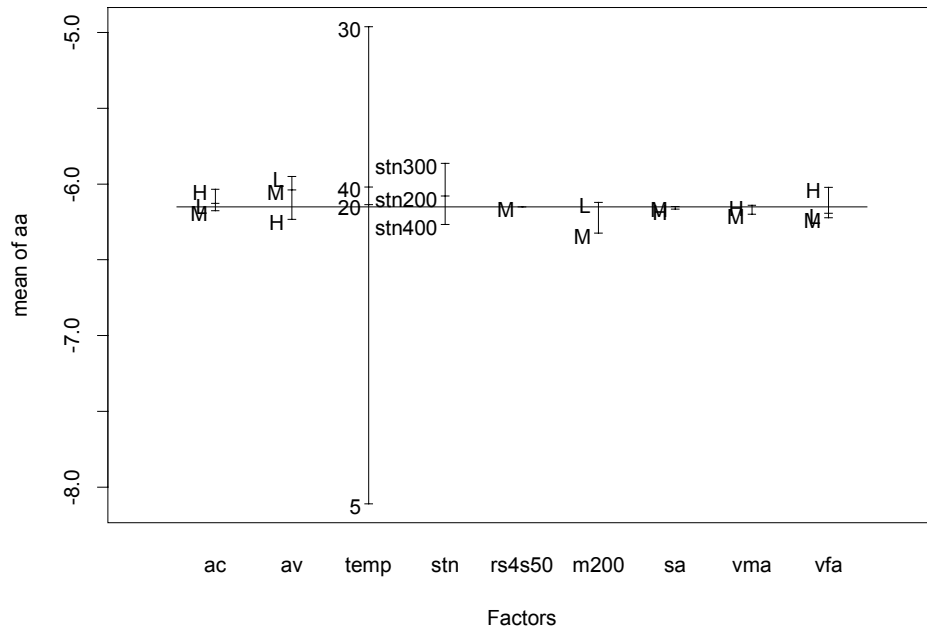

Figure B.4.52. Design plot of *aa* (regression: fine).

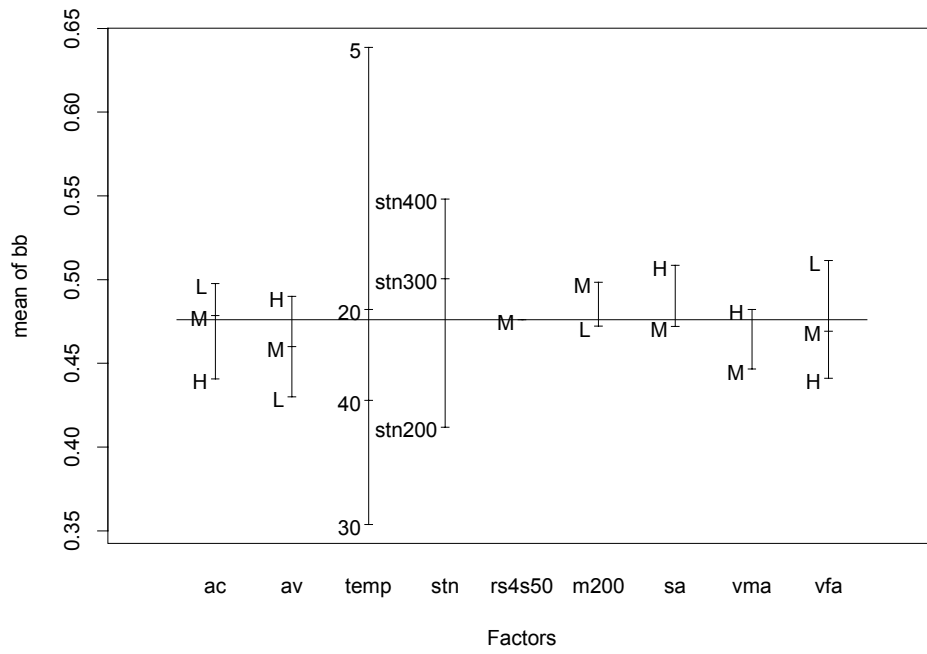

Figure B.4.53. Design plot of *bb* (regression: fine).

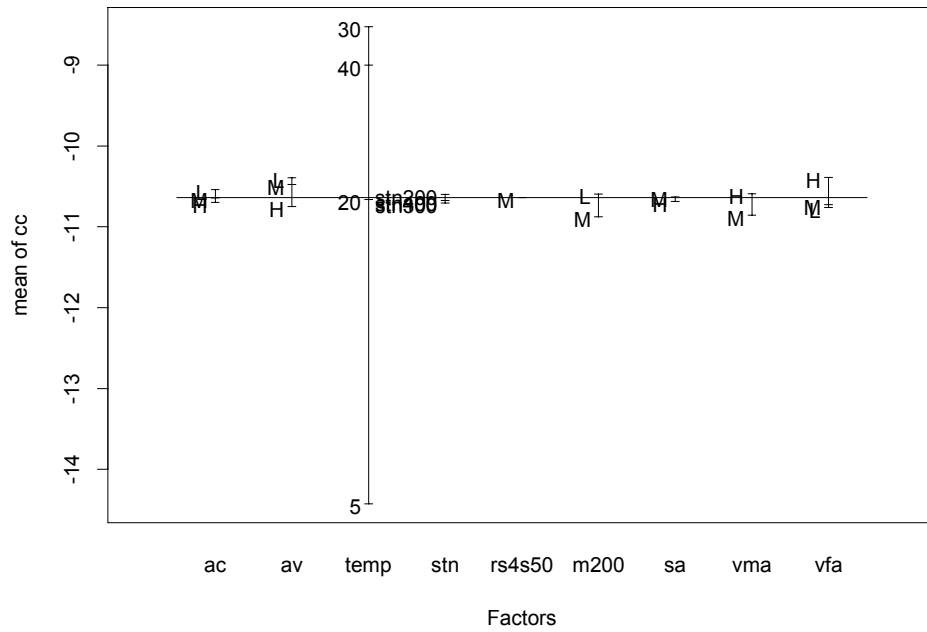

Figure B.4.54. Design plot of *cc* (regression: fine).

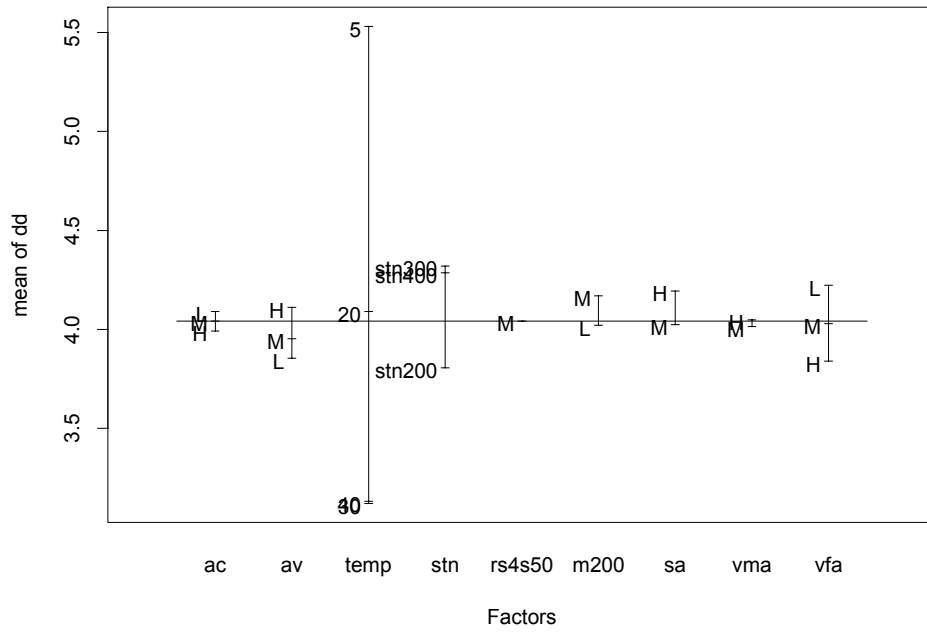

Figure B.4.55. Design plot of *dd* (regression: fine).

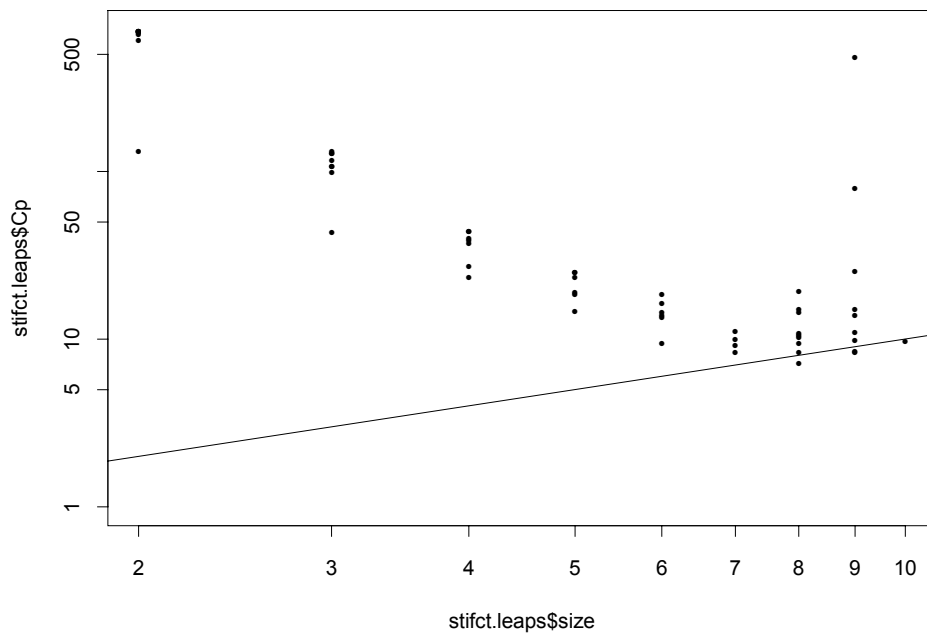

Figure B.4.56. C_p plot for the model selection of initial stiffness (fine).

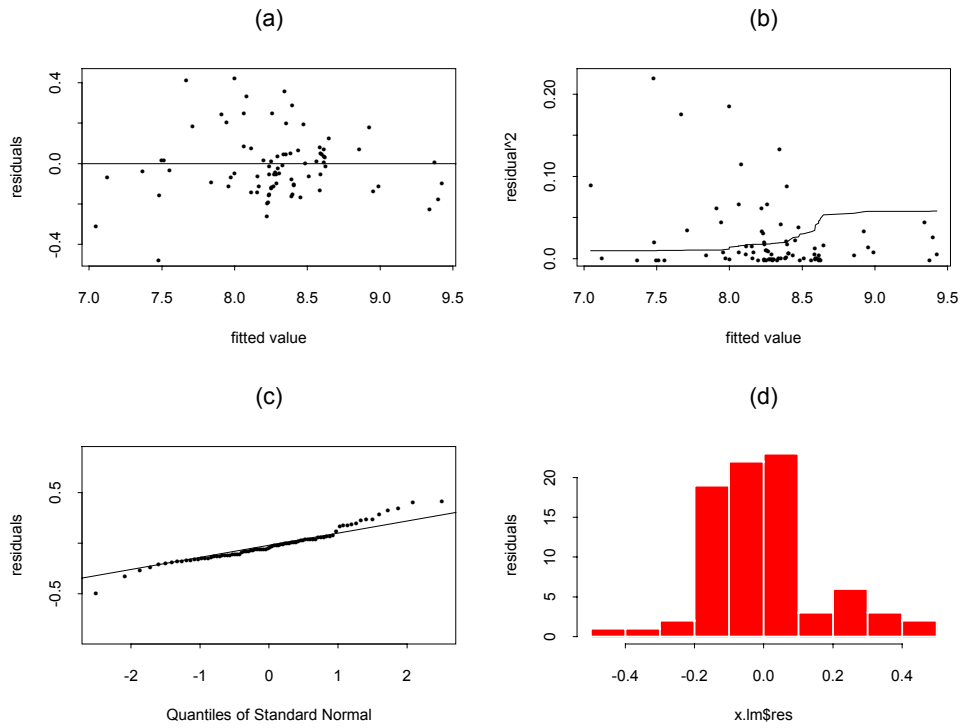

Figure B.4.57. Residual plots for the regression model of initial stiffness (fine).

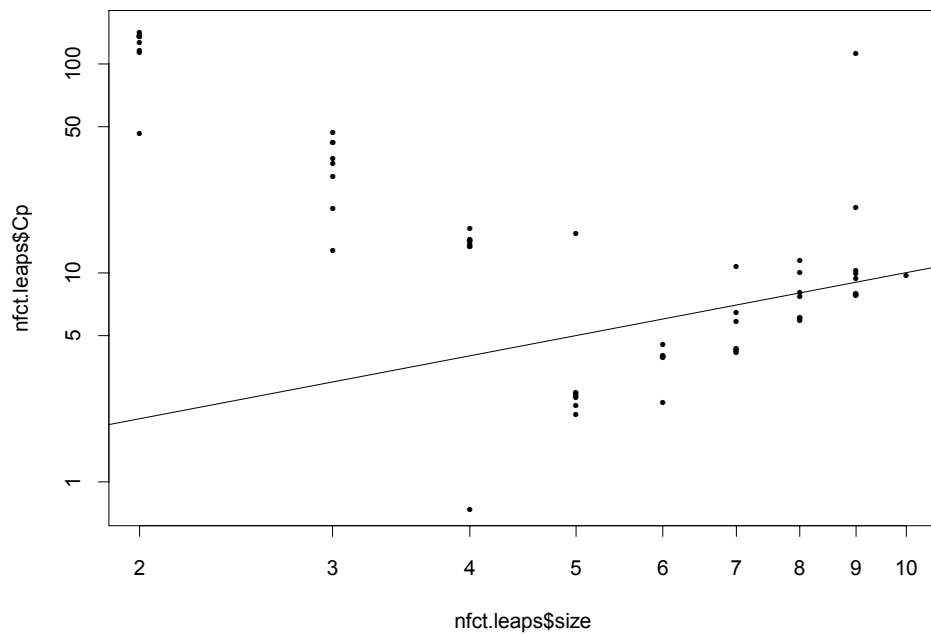

Figure B.4.58. C_p plot for the model selection of fatigue life (fine).

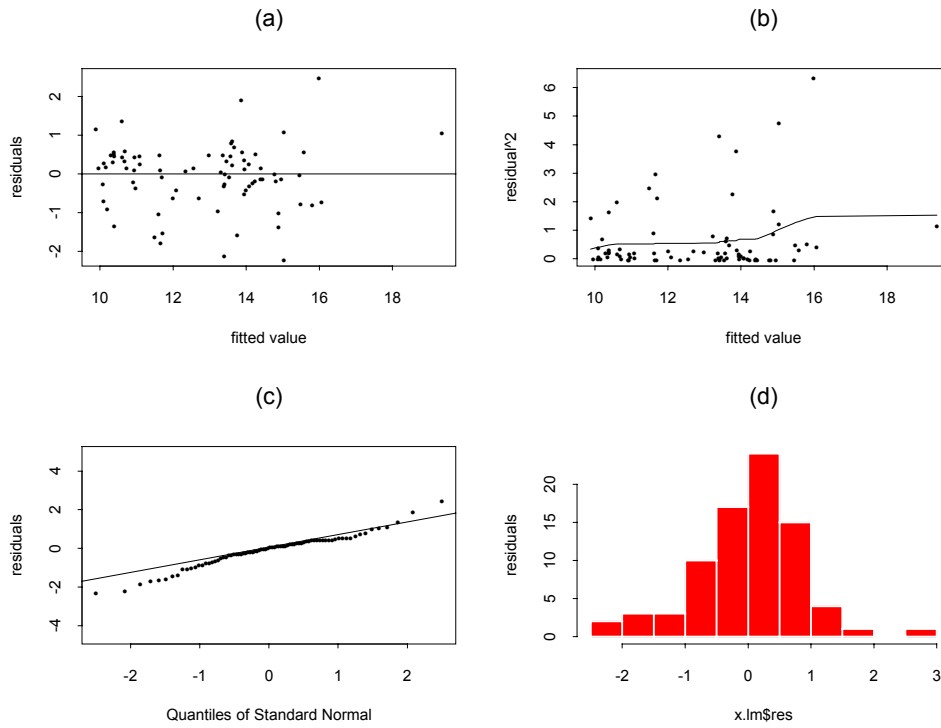

Figure B.4.59. Residual plots for the regression model of fatigue life (fine).

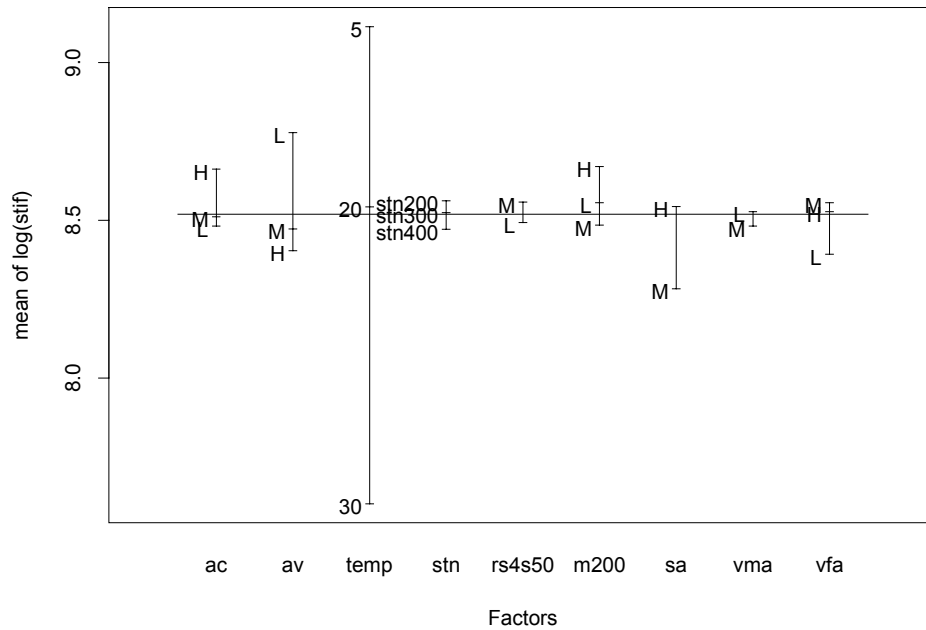

Figure B.4.60. Design plot of $\ln(\text{stif})$ (regression: fine-plus).

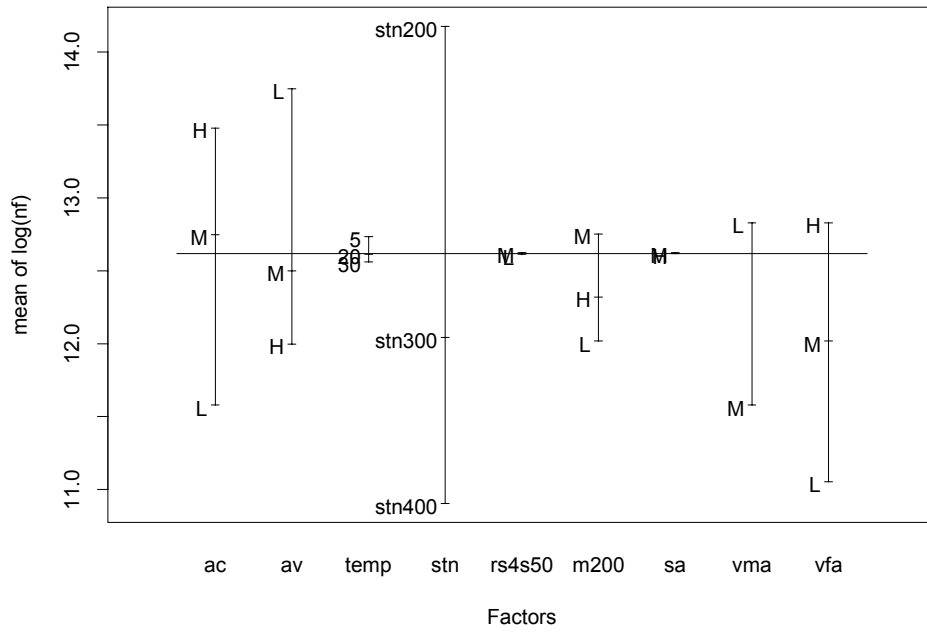

Figure B.4.61. Design plot of *lnnf* (regression: fine-plus).

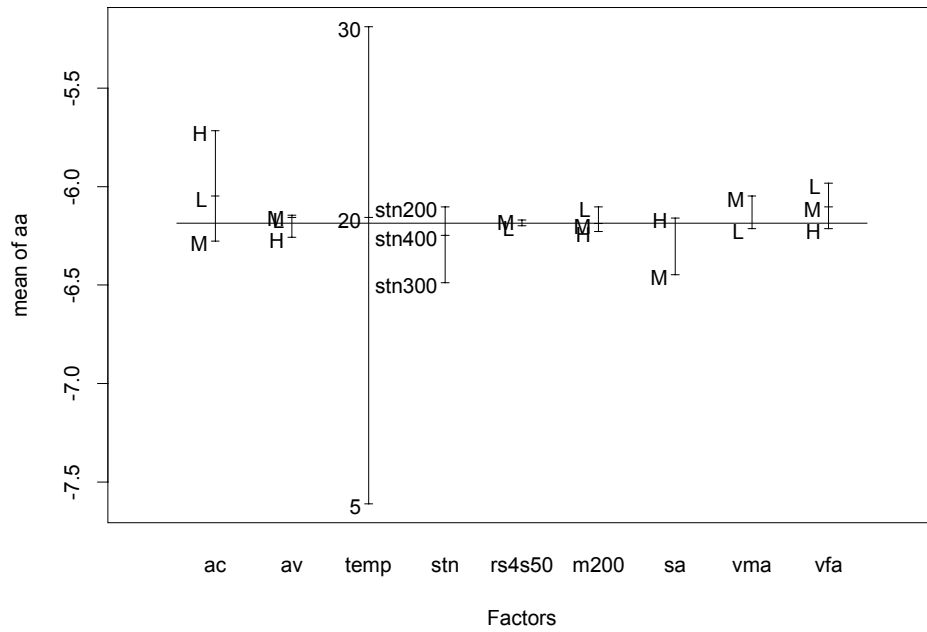

Figure B.4.62. Design plot of *aa* (regression: fine-plus).

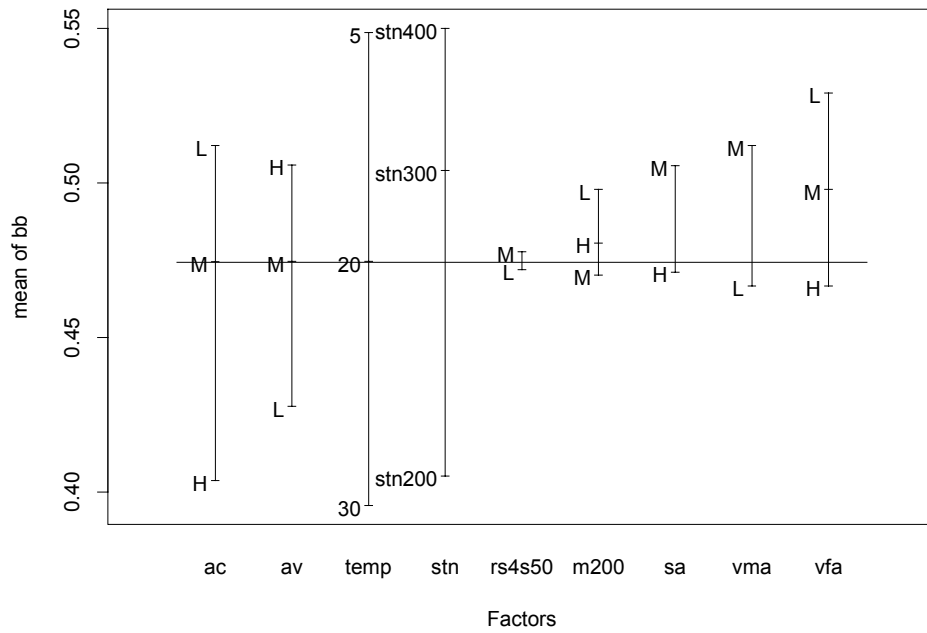

Figure B.4.63. Design plot of *bb* (regression: fine-plus).

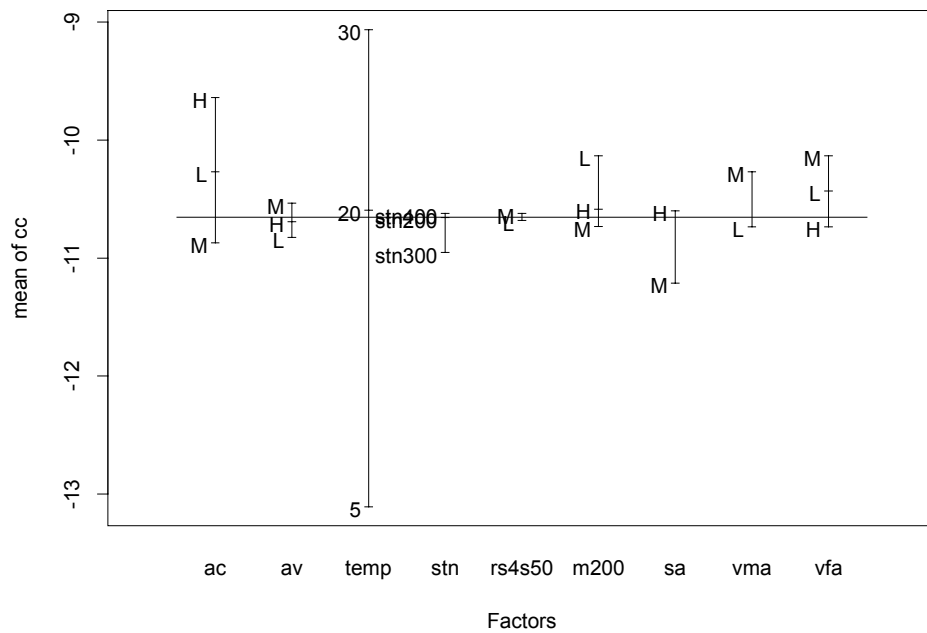

Figure B.4.64. Design plot of *cc* (regression: fine-plus).

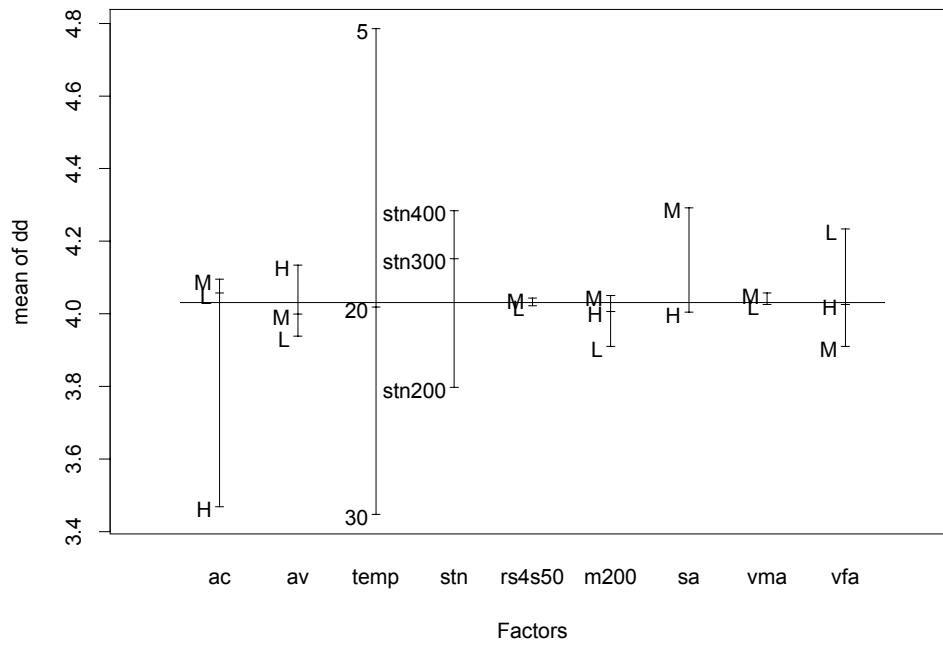

Figure B.4.65. Design plot of dd (regression: fine-plus).

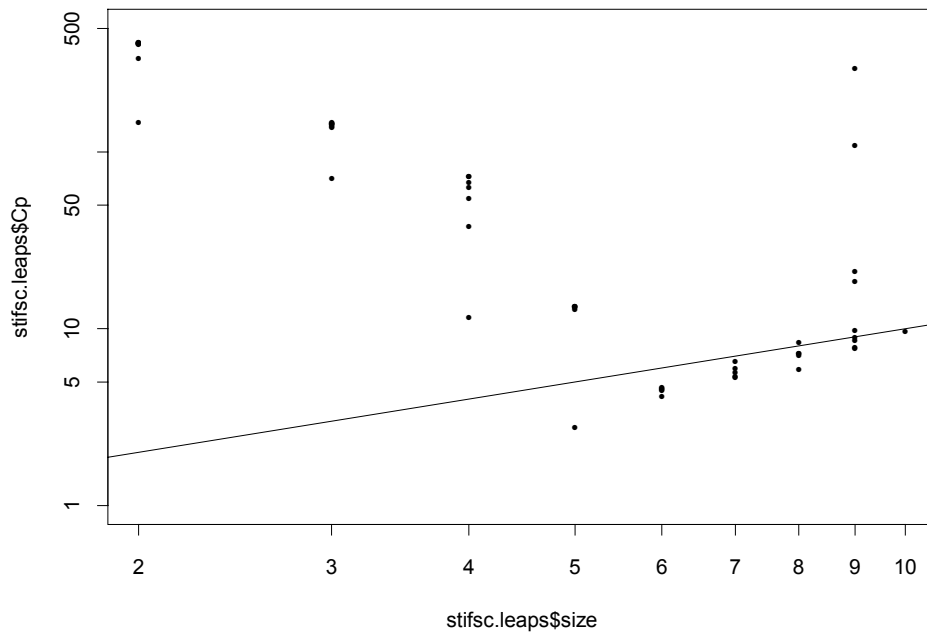

Figure B.4.66. C_p plot for the model selection of initial stiffness (fine-plus).

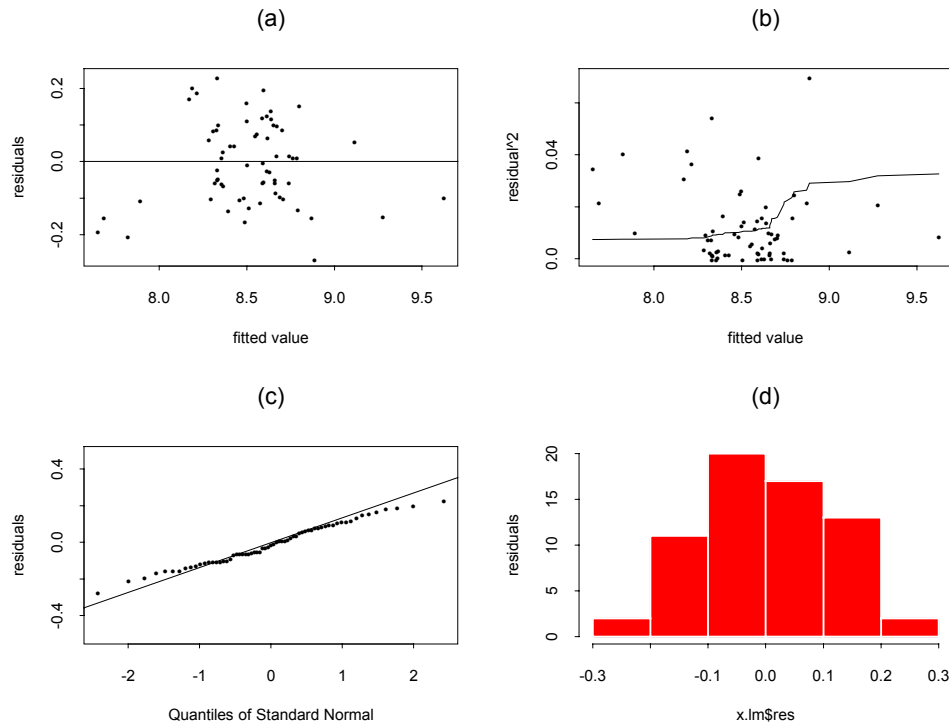

Figure B.4.67. Residual plots for the regression model of initial stiffness (fine-plus).

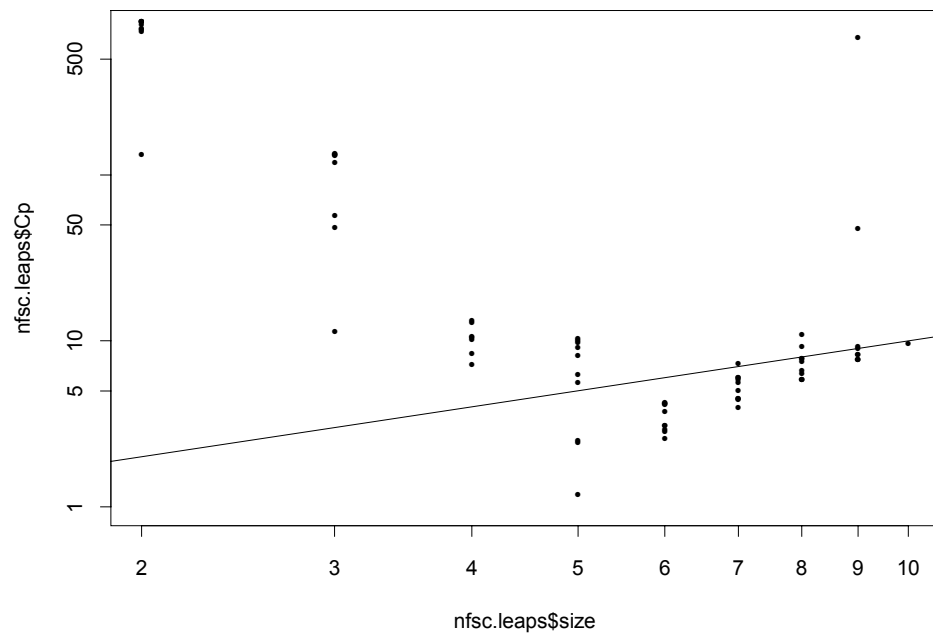

Figure B.4.68. C_p plot for the model selection of fatigue life (fine-plus).

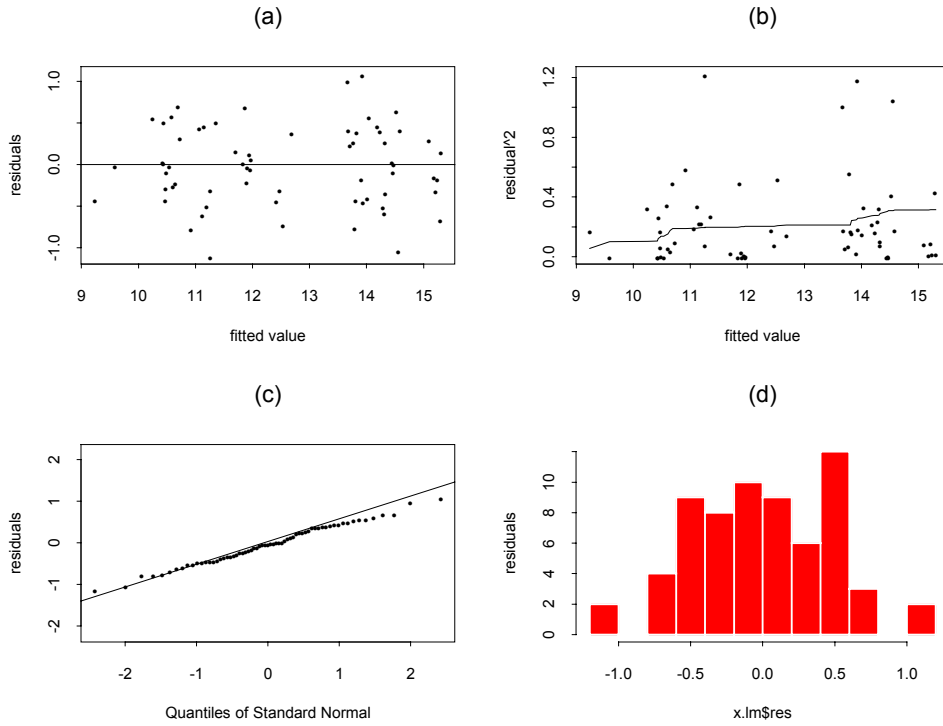

Figure B.4.69. Residual plots for the regression model of fatigue life (fine-plus).

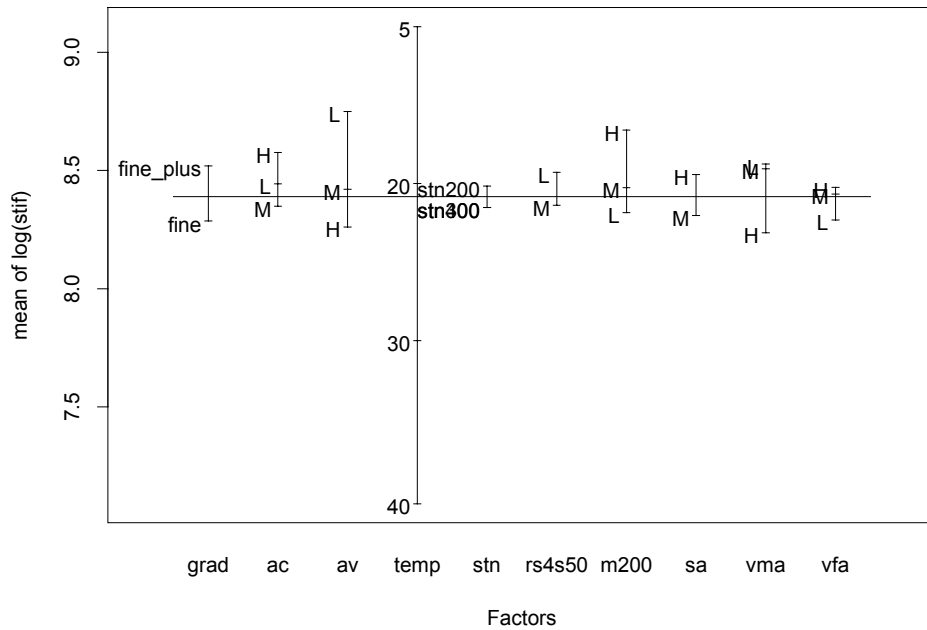

Figure B.4.70. Design plot of *lnstif* (regression: fine and fine-plus).

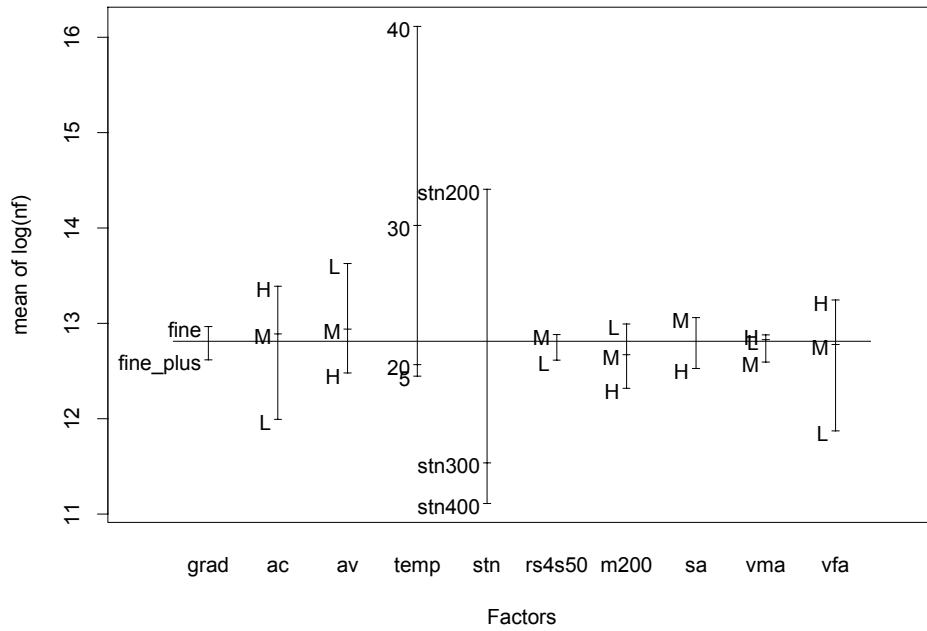

Figure B.4.71. Design plot of $\ln nf$ (regression: fine and fine-plus).

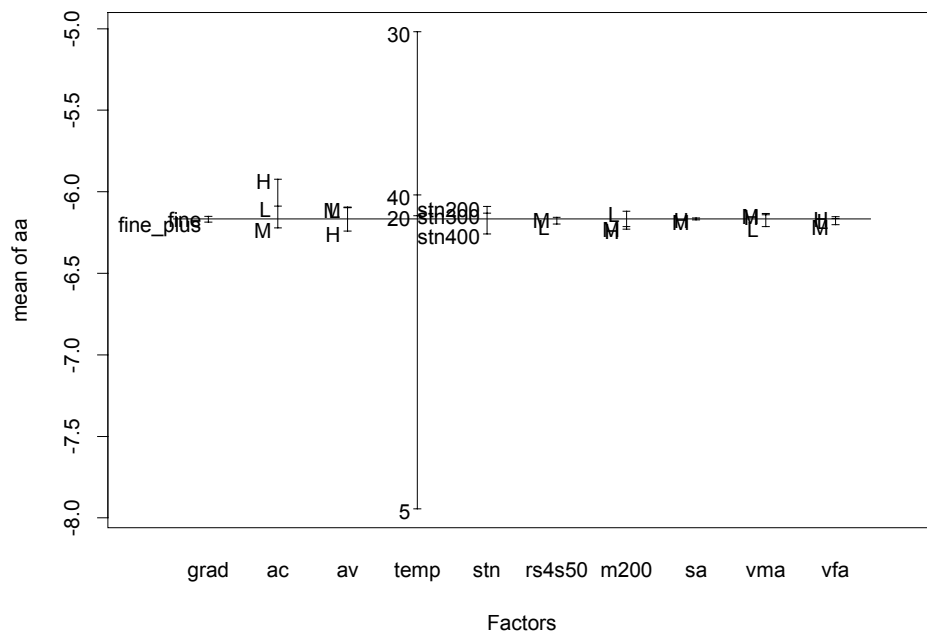

Figure B.4.72. Design plot of aa (regression: fine and fine-plus).

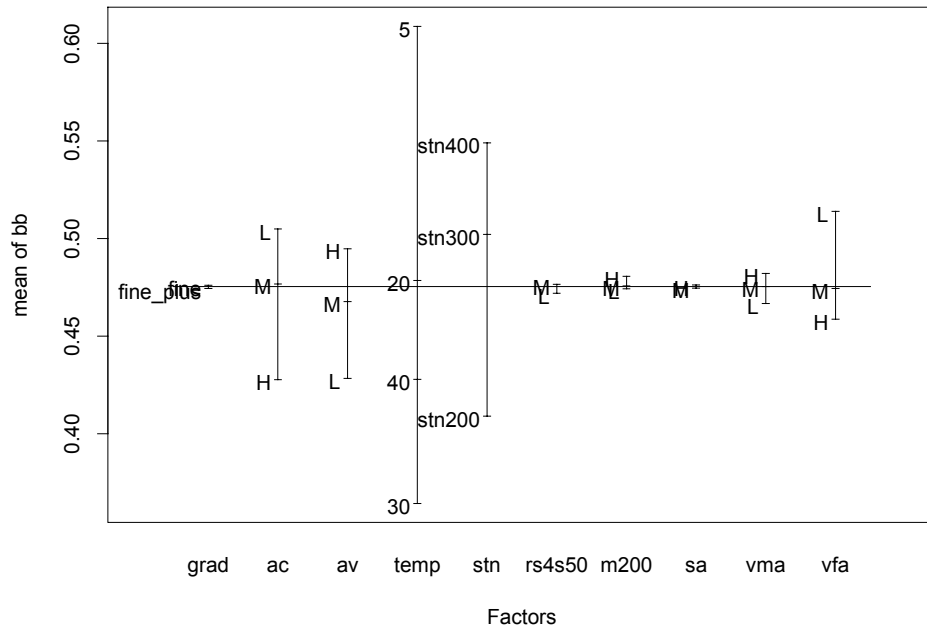

Figure B.4.73. Design plot of *bb* (regression: fine and fine-plus).

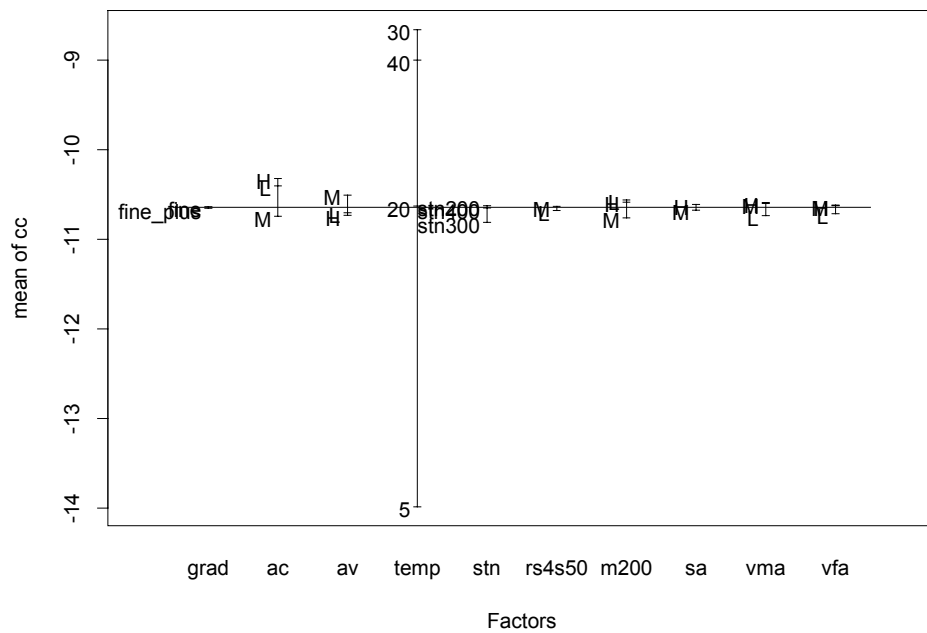

Figure B.4.74. Design plot of *cc* (regression: fine and fine-plus).

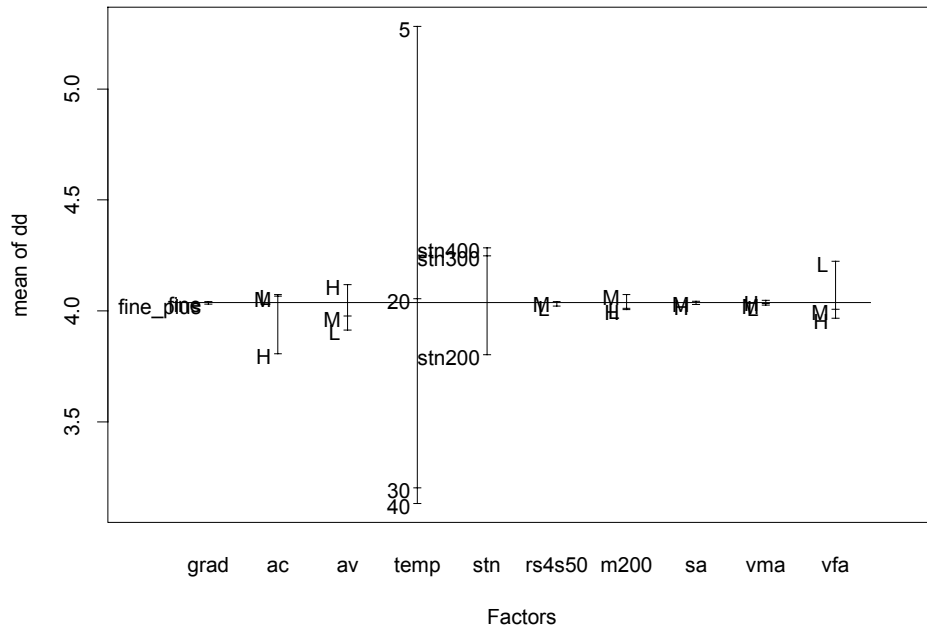

Figure B.4.75. Design plot of dd (regression: fine and fine-plus).

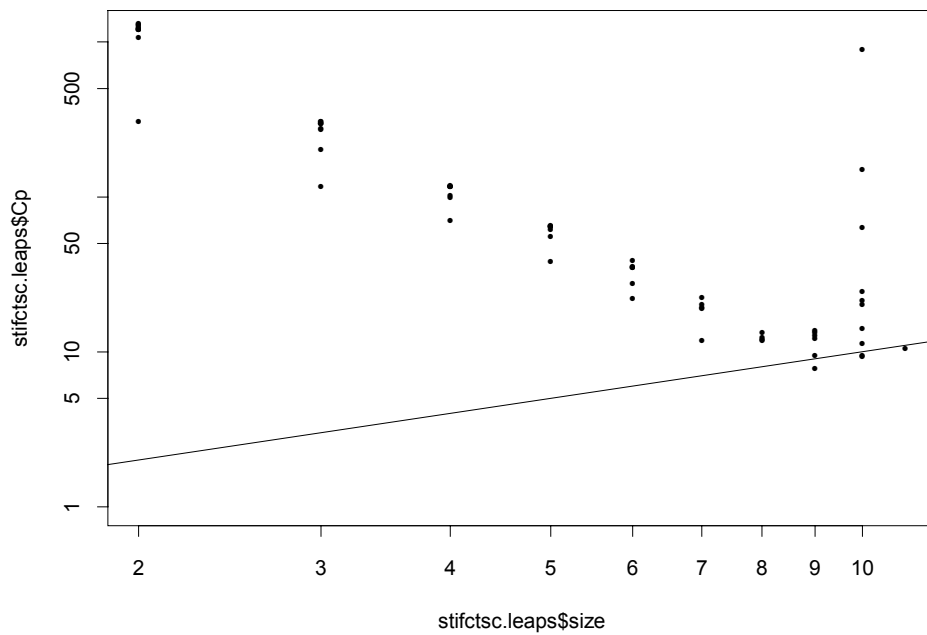

Figure B.4.76. C_p plot for the model selection of initial stiffness (fine and fine-plus).

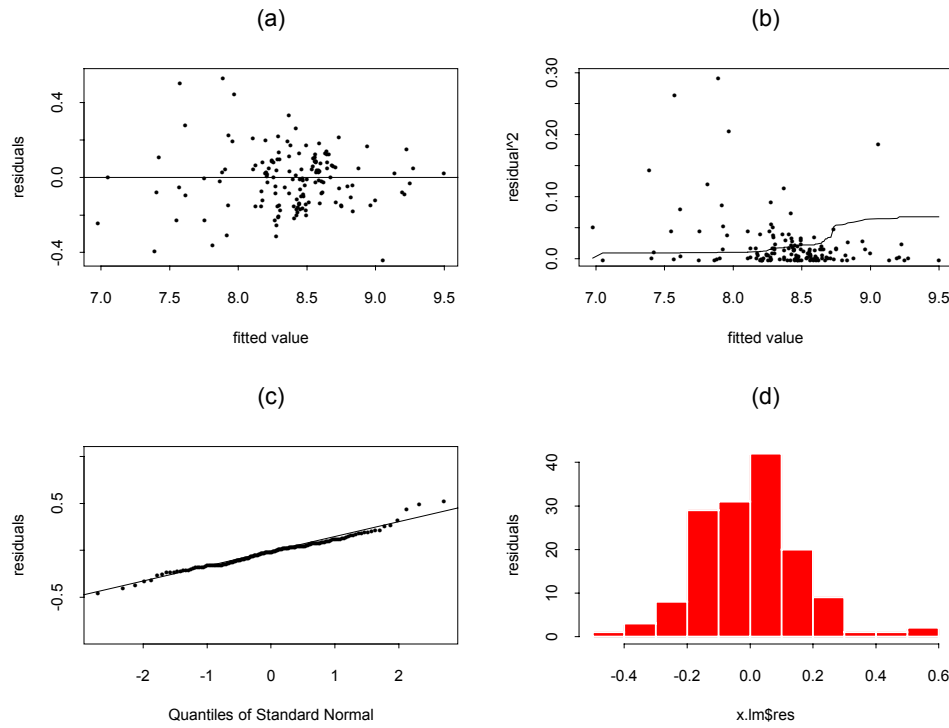

Figure B.4.77. Residual plots for the regression model of initial stiffness (fine and fine-lus).

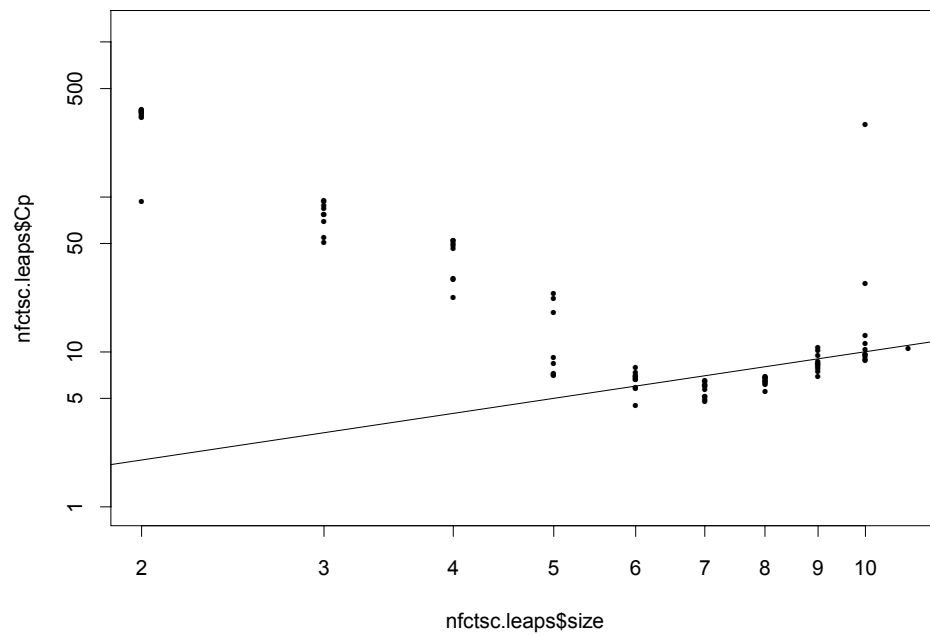

Figure B.4.78. C_p plot for the model selection of fatigue life (fine and fine-plus).

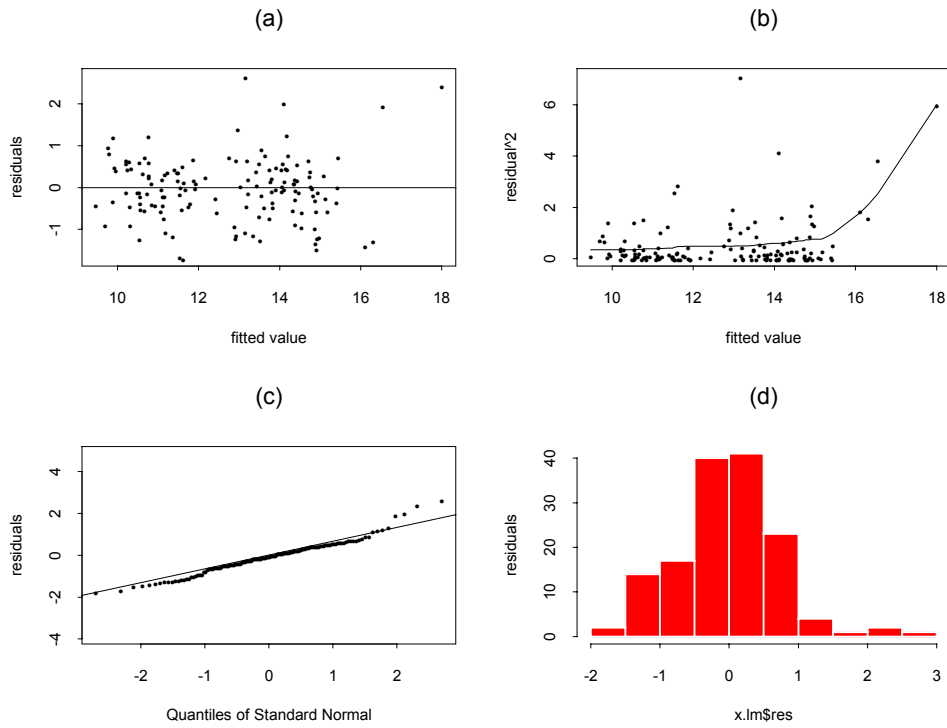

Figure B.4.79. Residual plots for the regression model of fatigue life (fine and fine-plus).

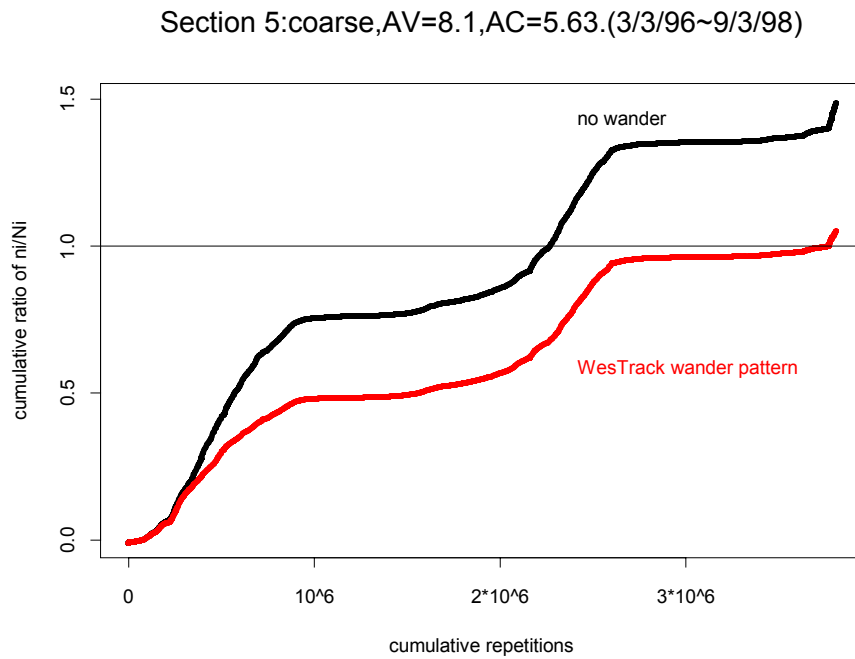

Figure B.6.1. Simulation result of crack initiation for WesTrack Section 5 (coarse, AV = 8.1 %, AC = 5.63 %).

Section 6:coarse,AV=10.8,AC=5.71.(3/3/96~9/3/98)

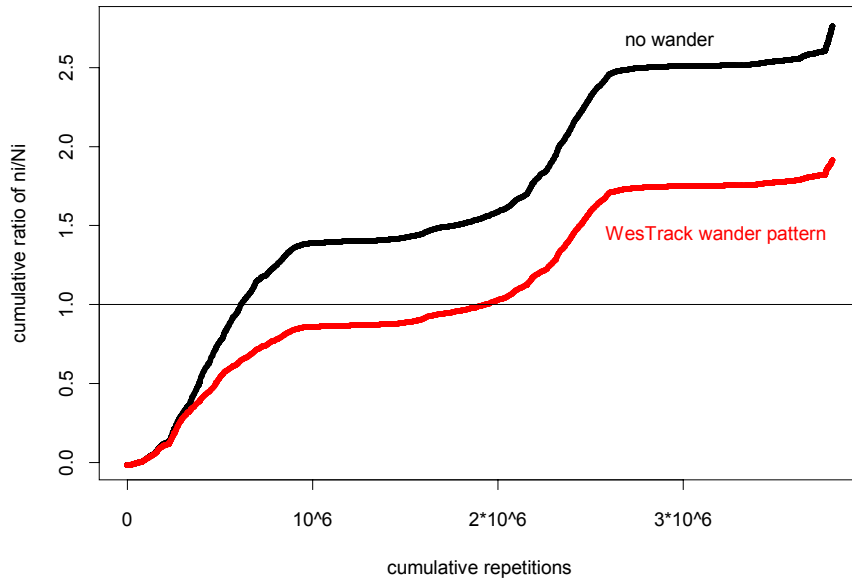

Figure B.6.2. Simulation result of crack initiation for WesTrack Section 6 (coarse, AV = 10.8 %, AC = 5.71 %).

Section 7:coarse,AV=6.9,AC=6.49.(3/3/96~9/3/98)

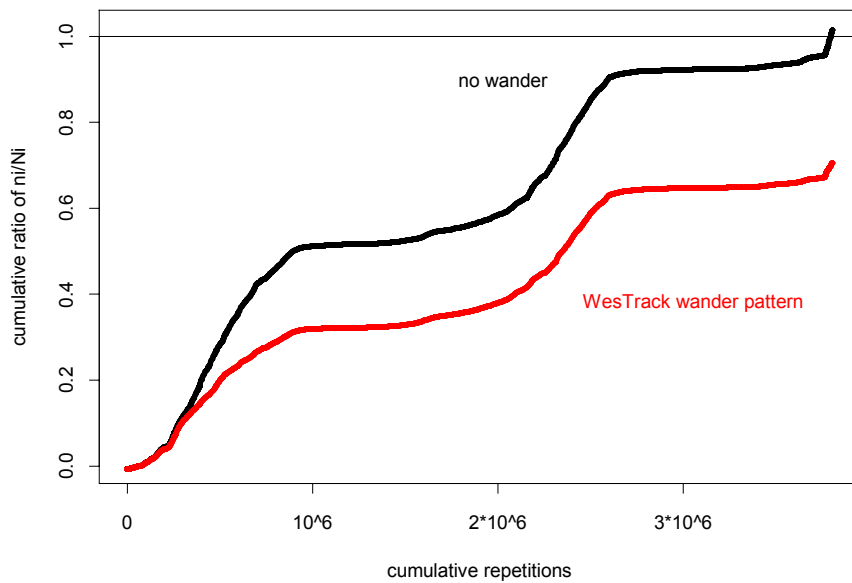

Figure B.6.3. Simulation result of crack initiation for WesTrack Section 7 (coarse, AV = 6.9 %, AC = 6.49 %).

Section 23:coarse,AV=4.9,AC=5.79.(3/3/96~9/3/98)

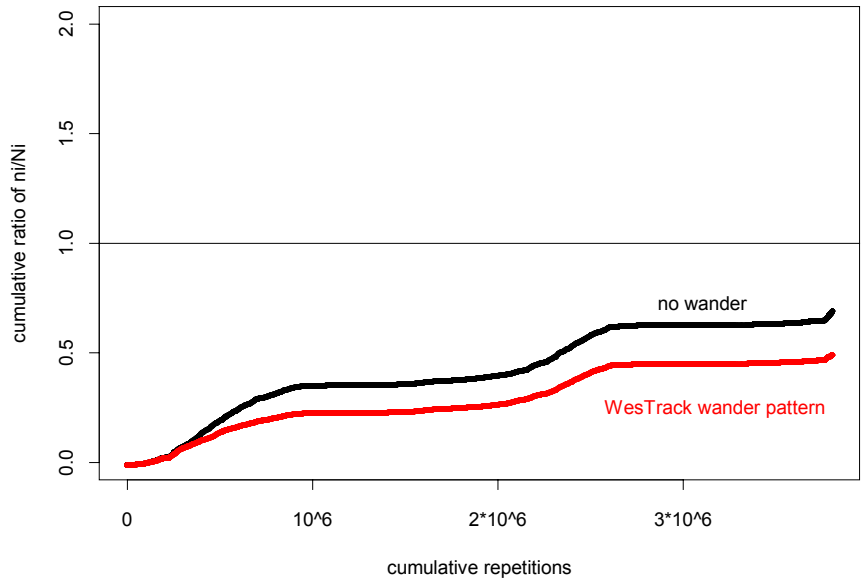

Figure B.6.4. Simulation result of crack initiation for WesTrack Section 23 (coarse, AV = 4.9 %, AC = 5.79 %).

Section 24:coarse,AV=7.2,AC=5.94.(3/3/96~9/3/98)

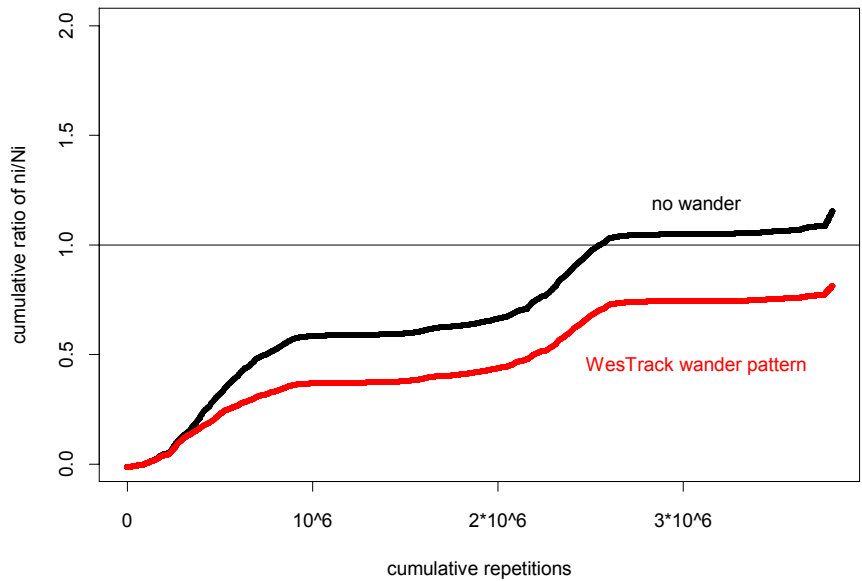

Figure B.6.5. Simulation result of crack initiation for WesTrack Section 24 (coarse, AV = 7.2 %, AC = 5.94 %).

Section 25:coarse,AV=3.7,AC=6.55.(3/3/96~9/3/98)

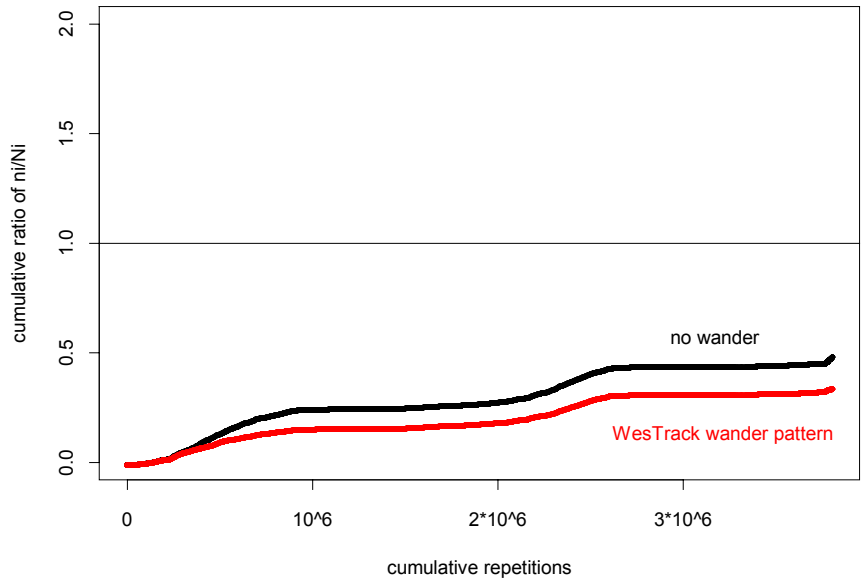

Figure B.6.6. Simulation result of crack initiation for WesTrack Section 25 (coarse, AV = 3.7 %, AC = 6.55 %).

Section 26:coarse,AV=11.0,AC=5.31.(3/3/96~9/3/98)

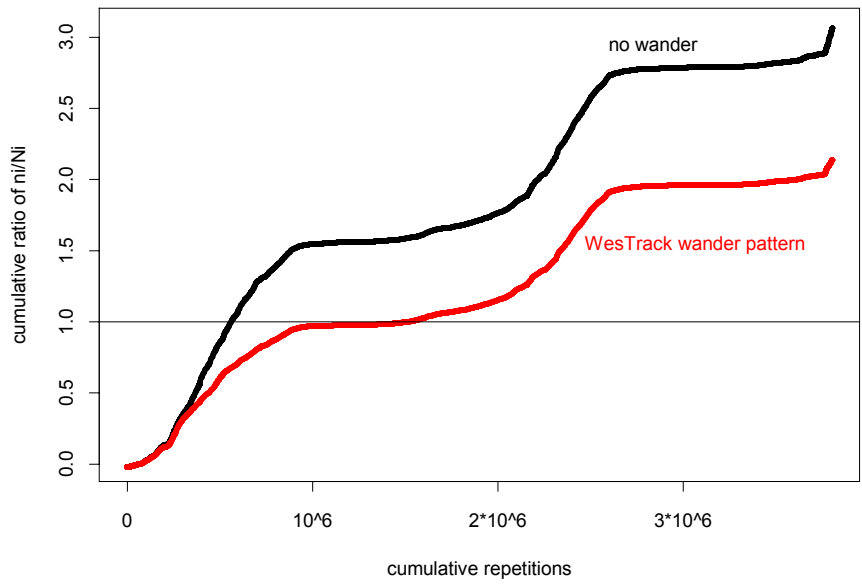

Figure B.6.7. Simulation result of crack initiation for WesTrack Section 26 (coarse, AV = 11.0 %, AC = 5.31 %).

Section 1: fine, AV=8.8, AC=5.35.(3/3/96~9/3/98)

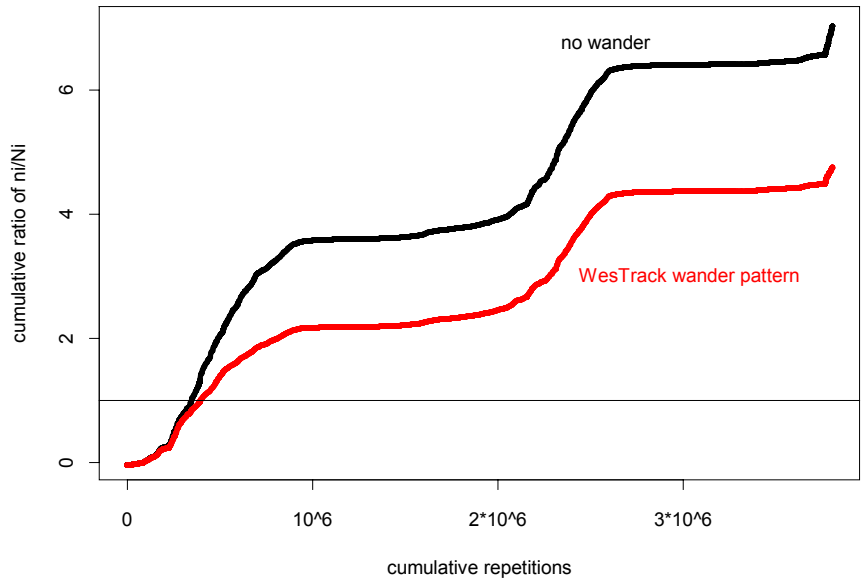

Figure B.6.8. Simulation result of crack initiation for WesTrack Section 1 (fine, AV = 8.8 %, AC = 5.35 %).

Section 2: fine, AV=10.4, AC=4.92.(3/3/96~9/3/98)

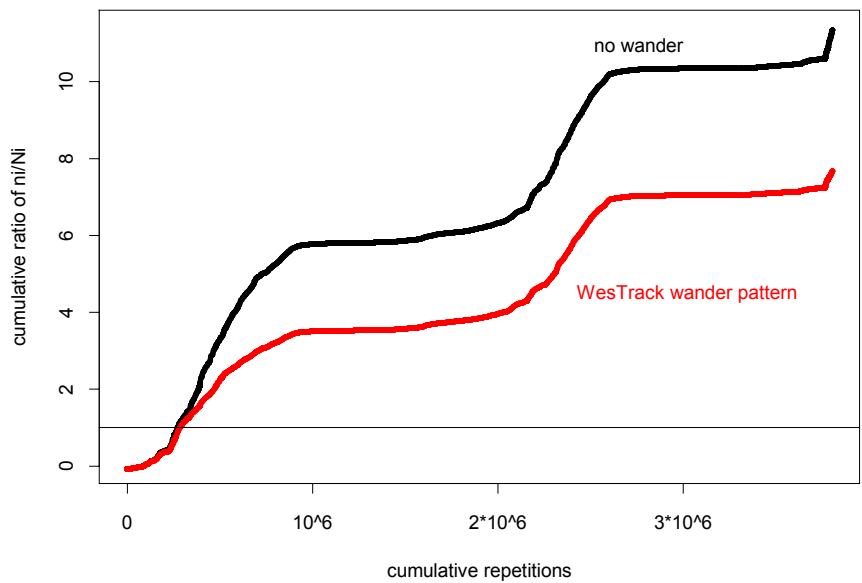

Figure B.6.9. Simulation result of crack initiation for WesTrack Section 2 (fine, AV = 10.4 %, AC = 4.92 %).

Section 3: fine, AV=12.4, AC=4.97. (3/3/96~9/3/98)

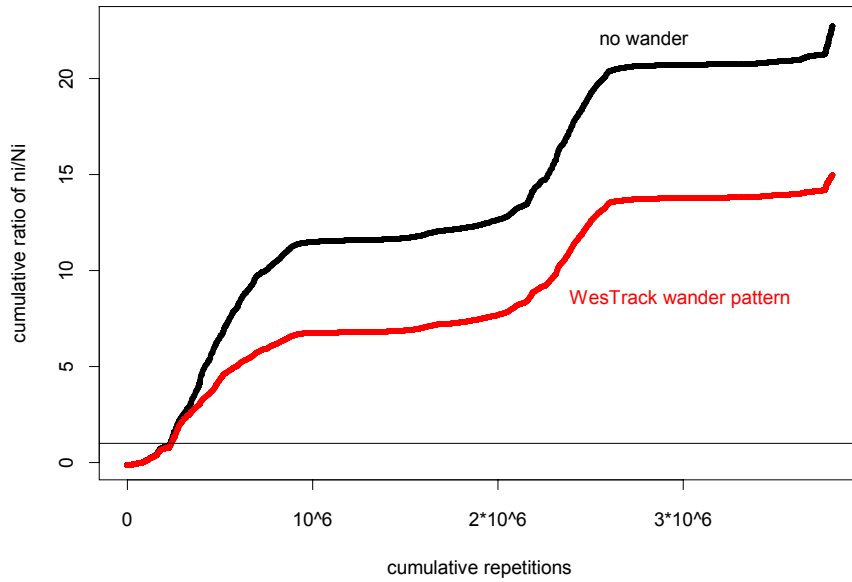

Figure B.6.10. Simulation result of crack initiation for WesTrack Section 3 (fine, AV = 12.4 %, AC = 4.97 %).

Section 4: fine, AV=6.6, AC=5.12. (3/3/96~9/3/98)

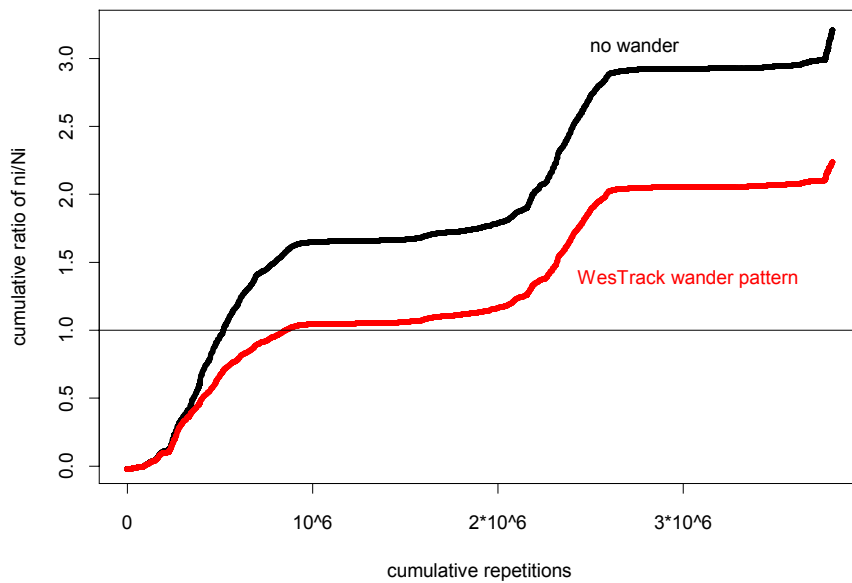

Figure B.6.11. Simulation result of crack initiation for WesTrack Section 4 (fine, AV = 6.6 %, AC = 5.12 %).

Section 14: fine, AV=9.0, AC=6.05.(3/3/96~9/3/98)

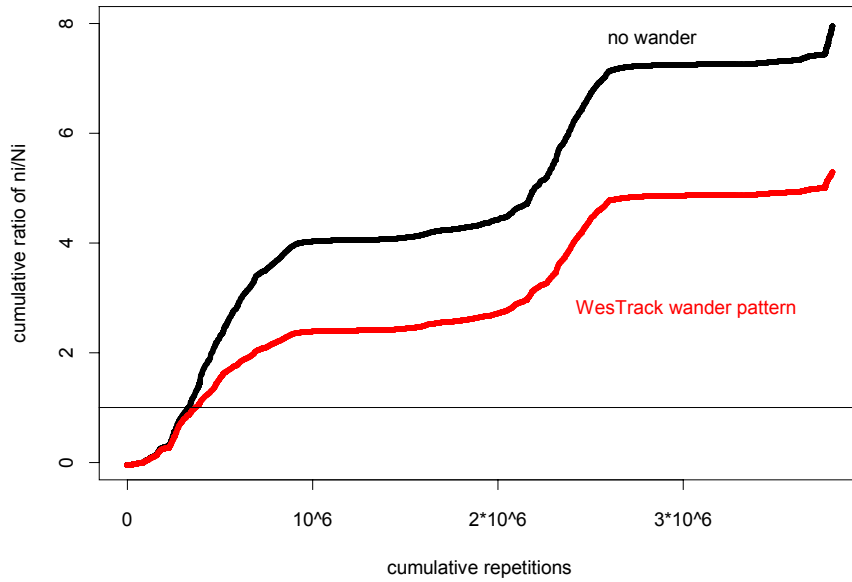

Figure B.6.12. Simulation result of crack initiation for WesTrack Section 14 (fine, AV = 9.0 %, AC = 6.05 %).

Section 15: fine, AV=8.7, AC=5.42.(3/3/96~9/3/98)

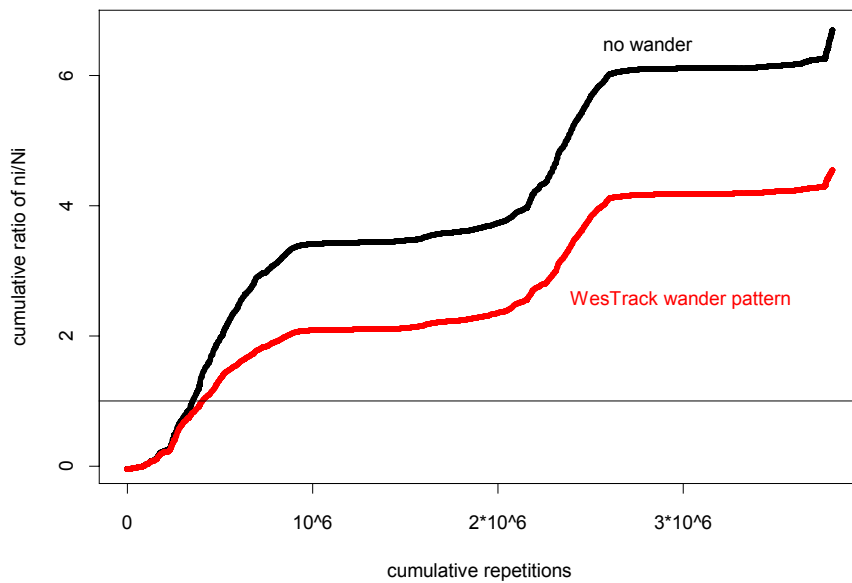

Figure B.6.13. Simulation result of crack initiation for WesTrack Section 15 (fine, AV = 8.7 %, AC = 5.42 %).

Section 16: fine, AV=12.2, AC=4.75. (3/3/96~9/3/98)

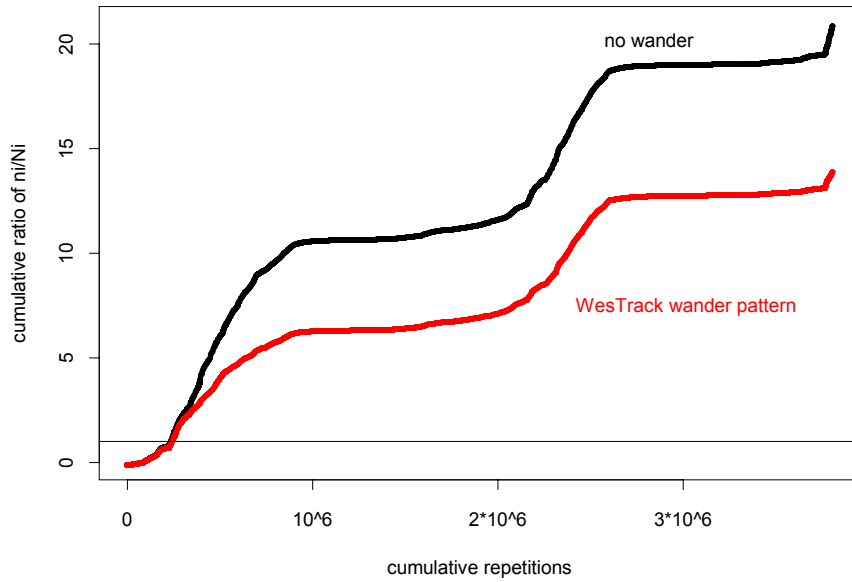

Figure B.6.14. Simulation result of crack initiation for WesTrack Section 16 (fine, AV = 12.2 %, AC = 4.75 %).

Section 17: fine, AV=11.0, AC=5.74. (3/3/96~9/3/98)

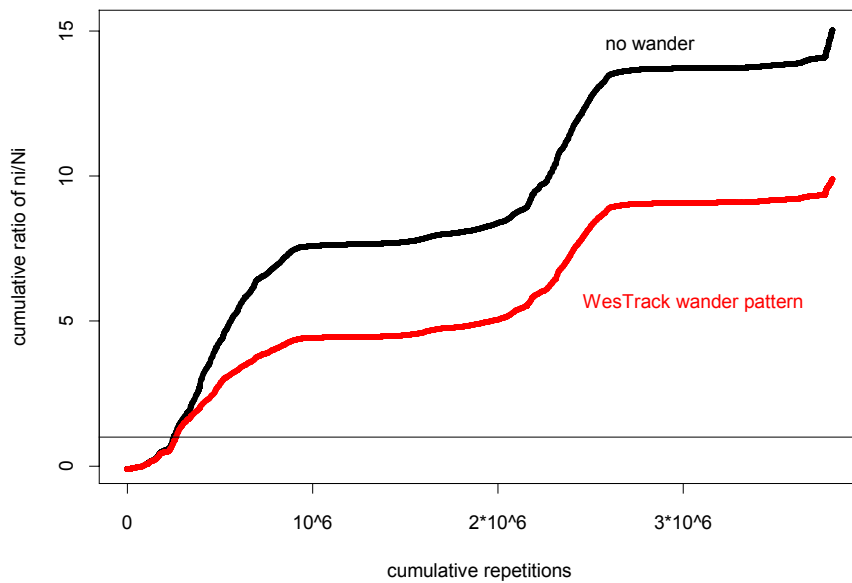

Figure B.6.15. Simulation result of crack initiation for WesTrack Section 17 (fine, AV = 11.0 %, AC = 5.74 %).

Section 18: fine, AV=4.3, AC=6.04.(3/3/96~9/3/98)

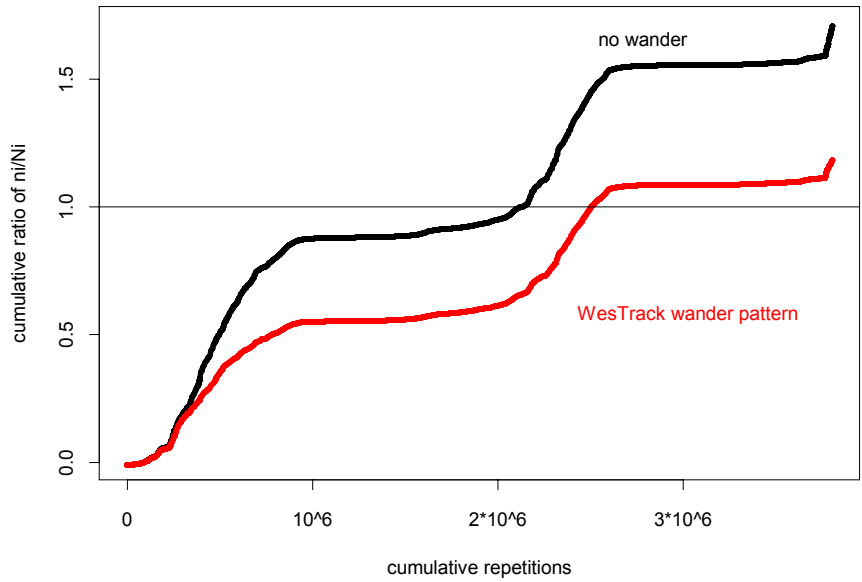

Figure B.6.16. Simulation result of crack initiation for WesTrack Section 18 (fine, AV = 4.3 %, AC = 6.04 %).

Section 9: fine plus, AV=3.9, AC=6.56.(3/3/96~9/3/98)

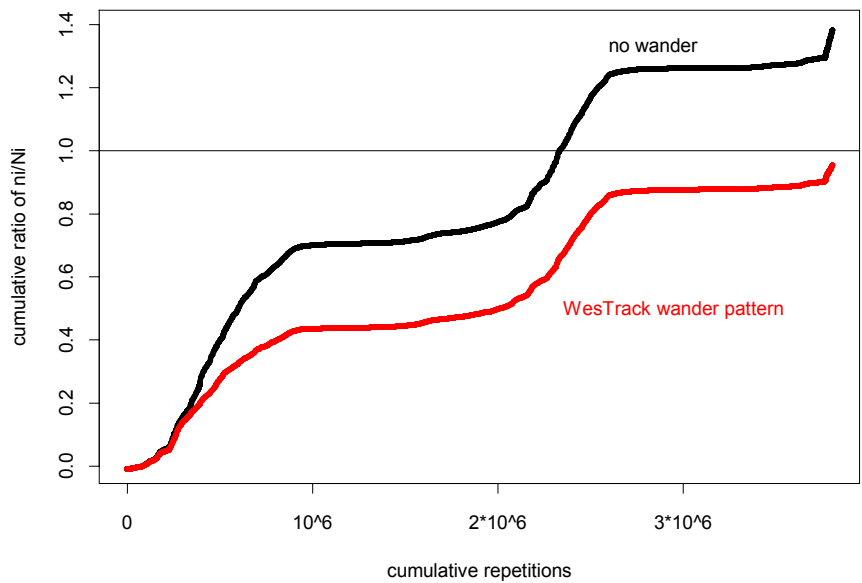

Figure B.6.17. Simulation result of crack initiation for WesTrack Section 9 (fine-plus, AV = 3.9 %, AC = 6.56 %).

Section 10: fine plus, AV=11.8, AC=5.28.(3/3/96~9/3/98)

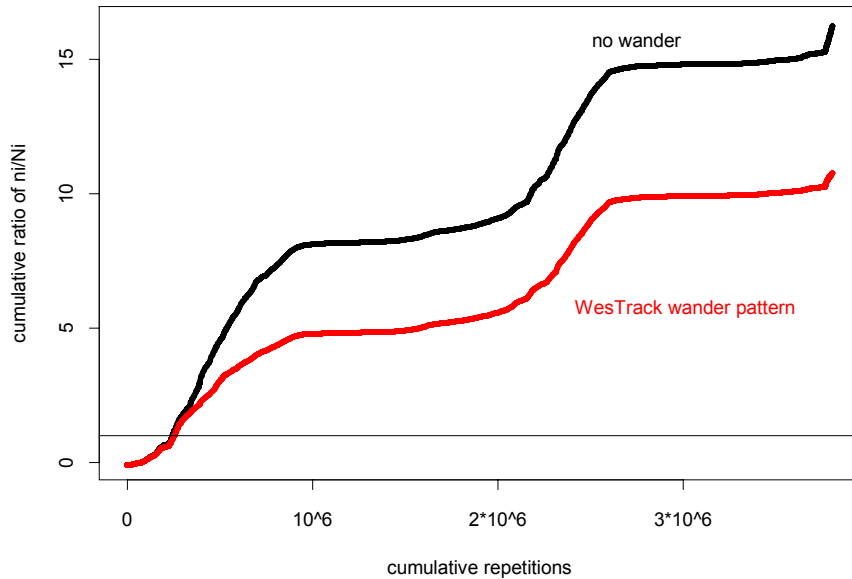

Figure B.6.18. Simulation result of crack initiation for WesTrack Section 10 (fine-plus, AV = 11.8 %, AC = 5.28 %).

Section 11: fine plus, AV=7.9, AC=5.99.(3/3/96~9/3/98)

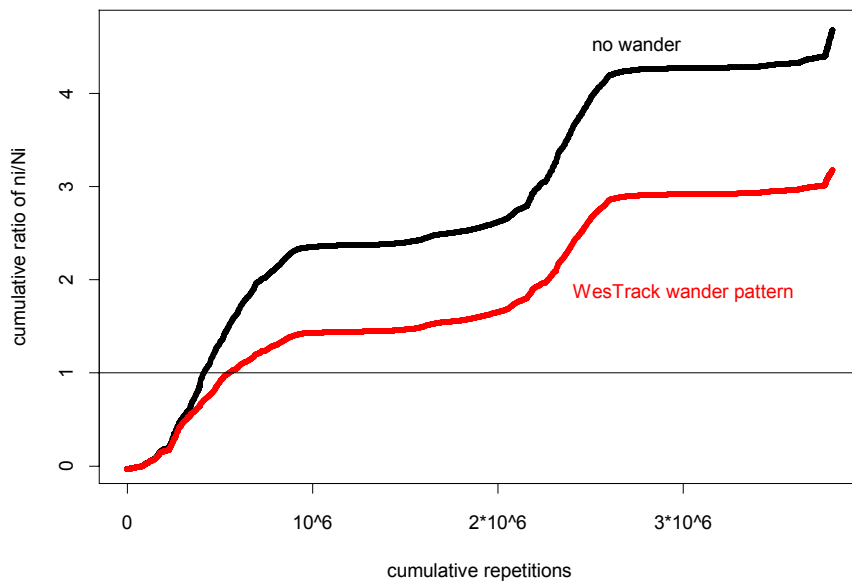

Figure B.6.19. Simulation result of crack initiation for WesTrack Section 11 (fine-plus, AV = 7.9 %, AC = 5.99 %).

Section 12: fine plus, AV=4.6, AC=5.84.(3/3/96~9/3/98)

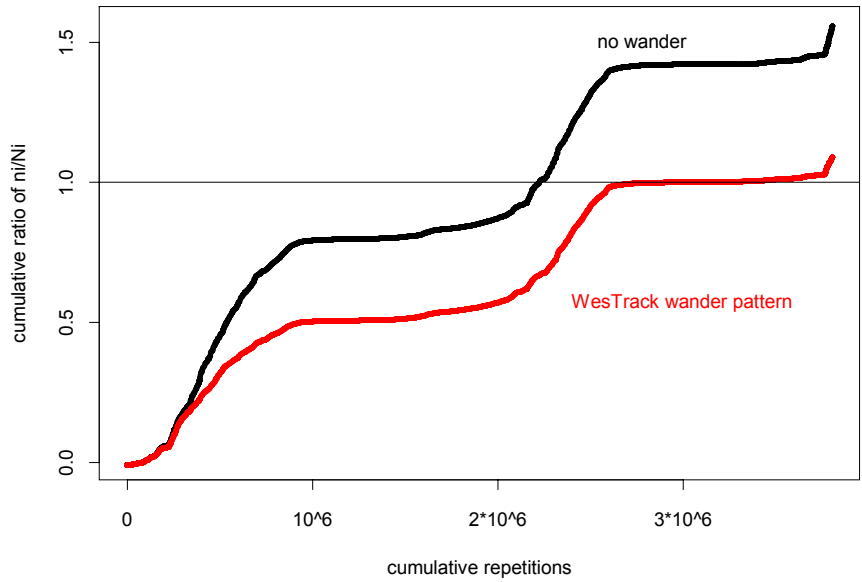

Figure B.6.20. Simulation result of crack initiation for WesTrack Section 12 (fine-plus, AV = 4.6 %, AC = 5.84 %).

Section 13: fine plus, AV=5.9, AC=6.51.(3/3/96~9/3/98)

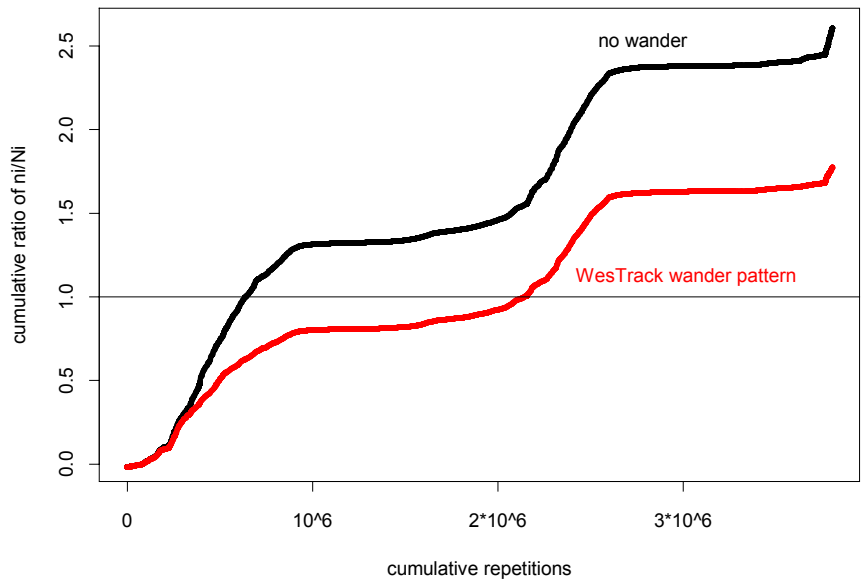

Figure B.6.21. Simulation result of crack initiation for WesTrack Section 13 (fine-plus, AV = 5.9 %, AC = 6.51 %).

Section 19: fine plus, AV=7.2, AC=5.89.(3/3/96~9/3/98)

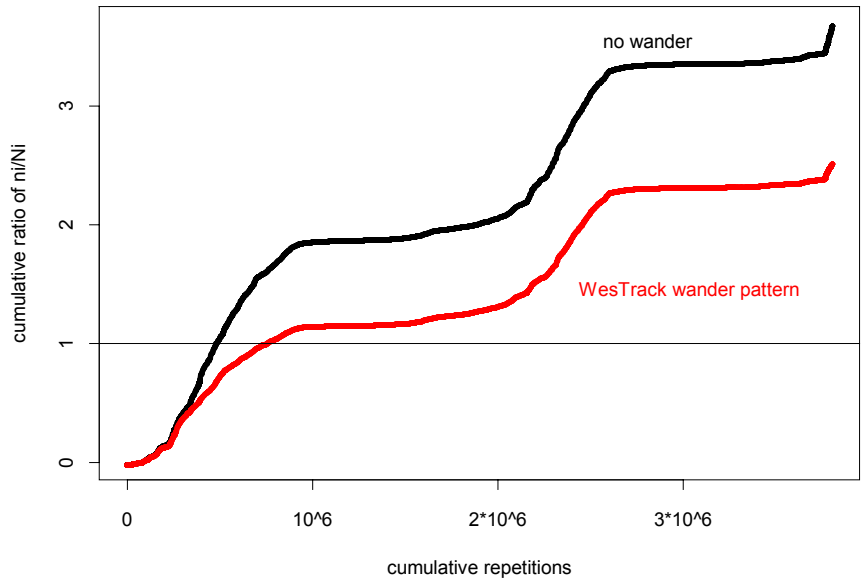

Figure B.6.22. Simulation result of crack initiation for WesTrack Section 19 (fine-plus, AV = 7.2 %, AC = 5.89 %).

Section 20: fine plus, AV=10.9, AC=5.88.(3/3/96~9/3/98)

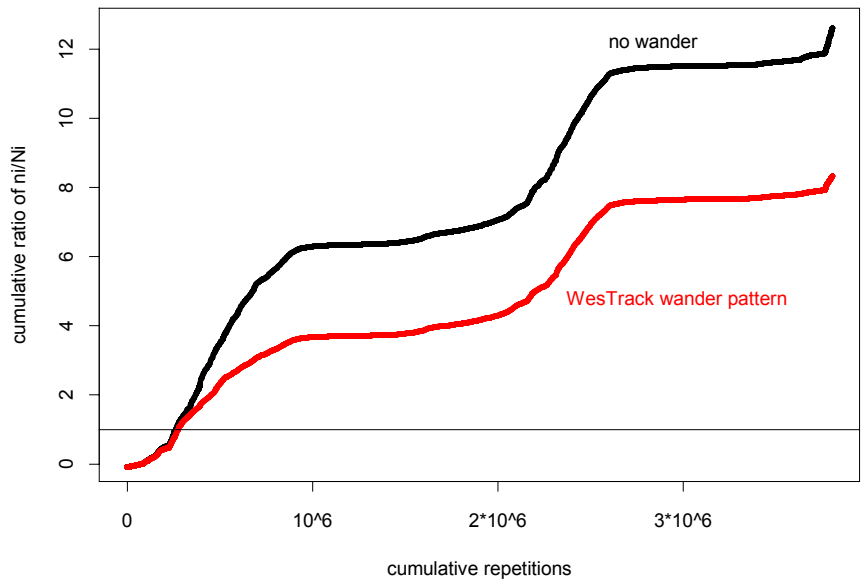

Figure B.6.23. Simulation result of crack initiation for WesTrack Section 20 (fine-plus, AV = 10.9 %, AC = 5.88 %).

Section 21: fine plus, AV=4.2, AC=6.75.(3/3/96~9/3/98)

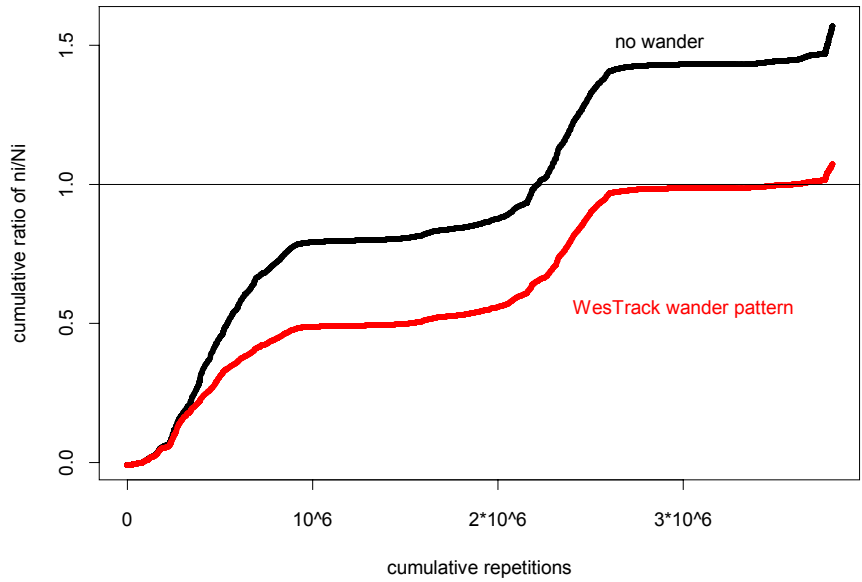

Figure B.6.24. Simulation result of crack initiation for WesTrack Section 21 (fine-plus, AV = 4.2 %, AC = 6.75 %).

Section 22: fine plus, AV=8.1, AC=5.23.(3/3/96~9/3/98)

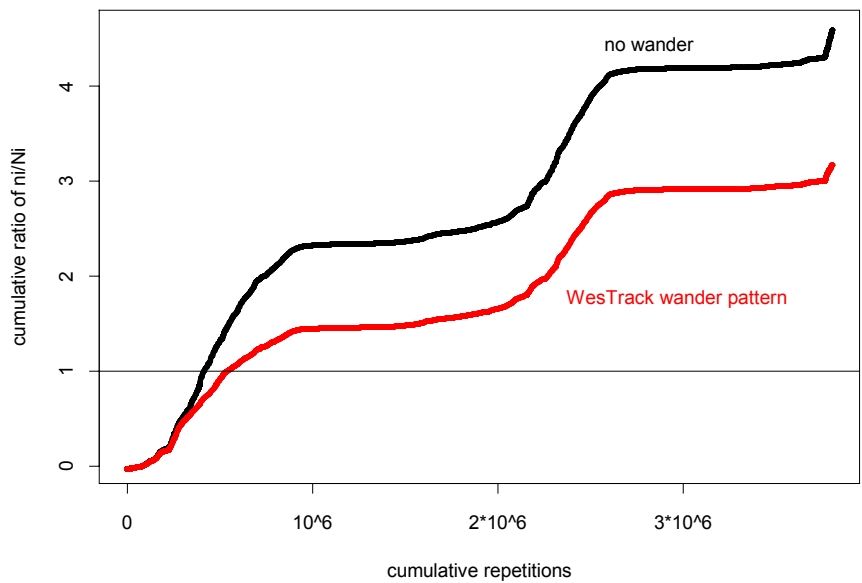
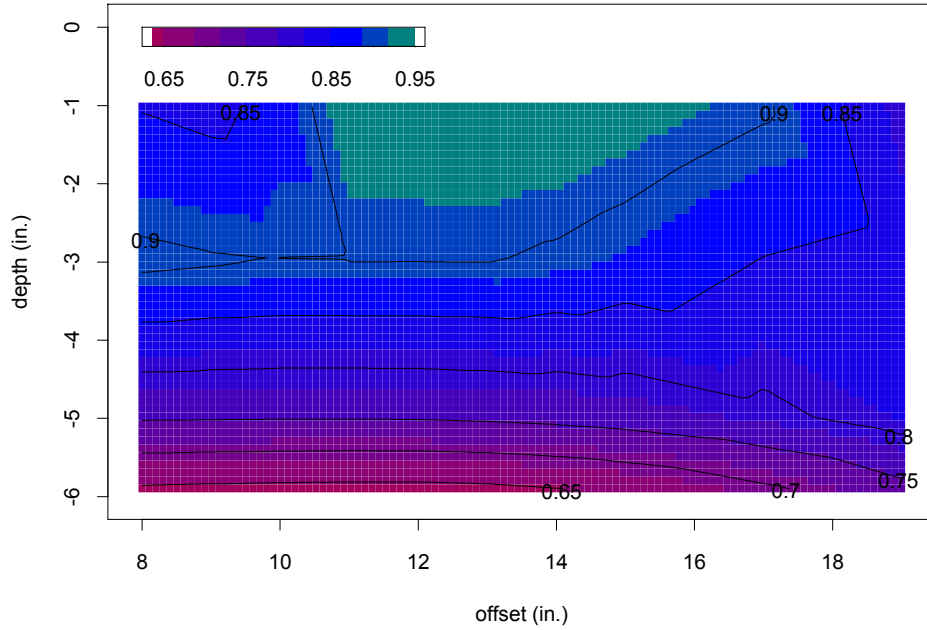

Figure B.6.25. Simulation result of crack initiation for WesTrack Section 22 (fine-plus, AV = 8.1 %, AC = 5.23 %).

section 1: fine, AC=5.55, AV=8.7, C.F.=1.0 (wander)



(a)

section 1: fine, AC=5.55, AV=8.7, C.F.=1.0 (no wander)

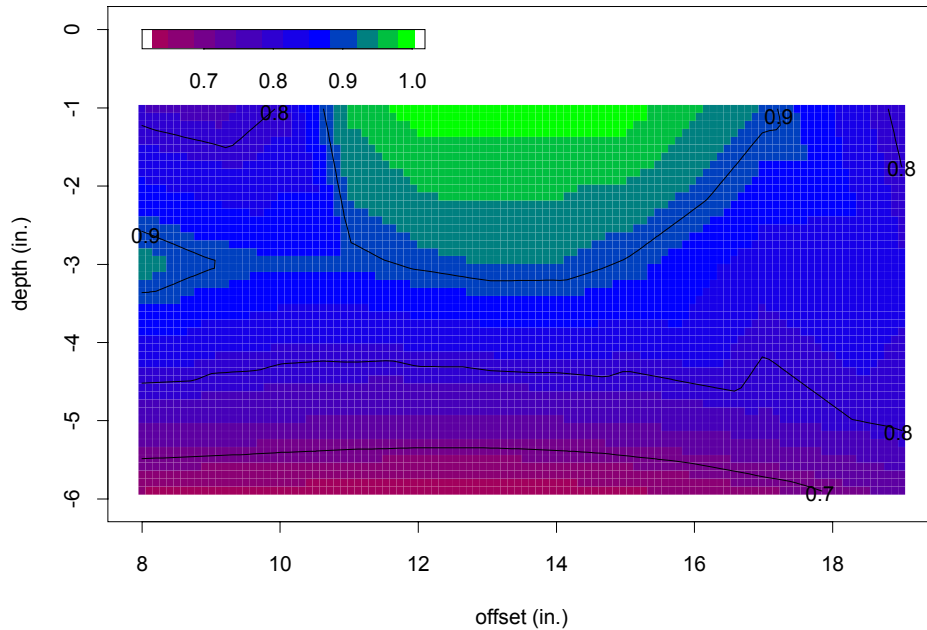

(b)

Figure B.7.1. Image-and-contour plots of SR of WesTrack Section 1 after 21,943 hours of simulation with a correction factor of 1.0: (a) wander and (b) no wander.

section 2: fine, AC=4.92, AV=10.4, C.F.=1.0 (wander)

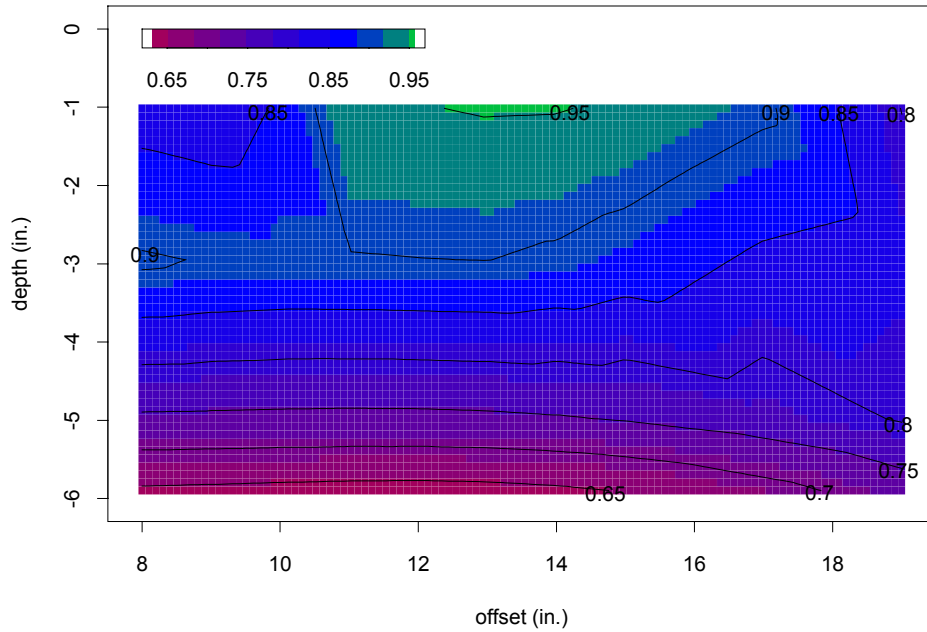

(a)

section 2: fine, AC=4.92, AV=10.4, C.F.=1.0 (no wander)

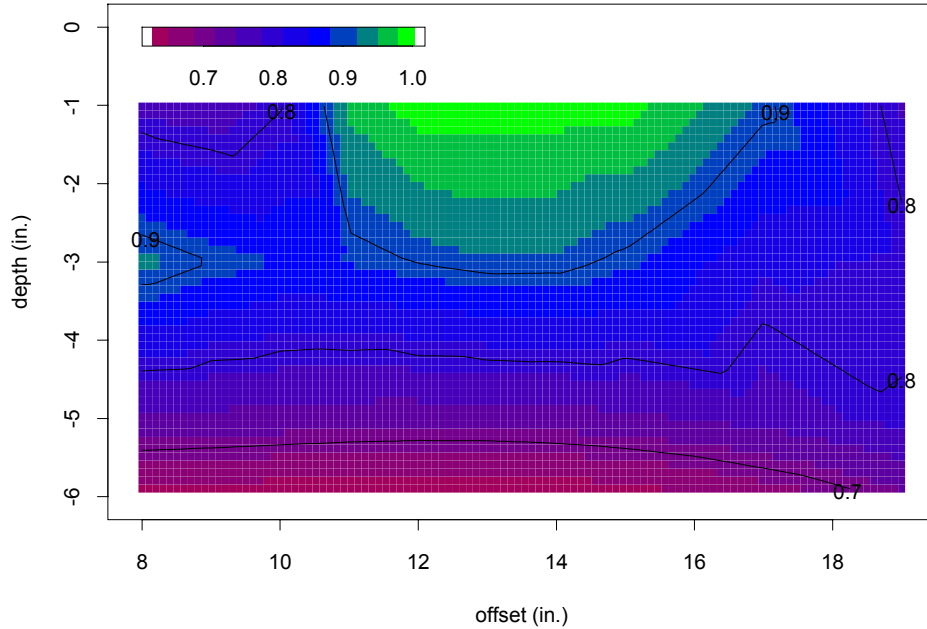

(b)

Figure B.7.2. Image-and-contour plots of SR of WesTrack Section 2 after 21,943 hours of simulation with a correction factor of 1.0: (a) wander and (b) no wander.

section 4: fine, AC=5.12, AV=6.6, C.F.=1.0 (wander)

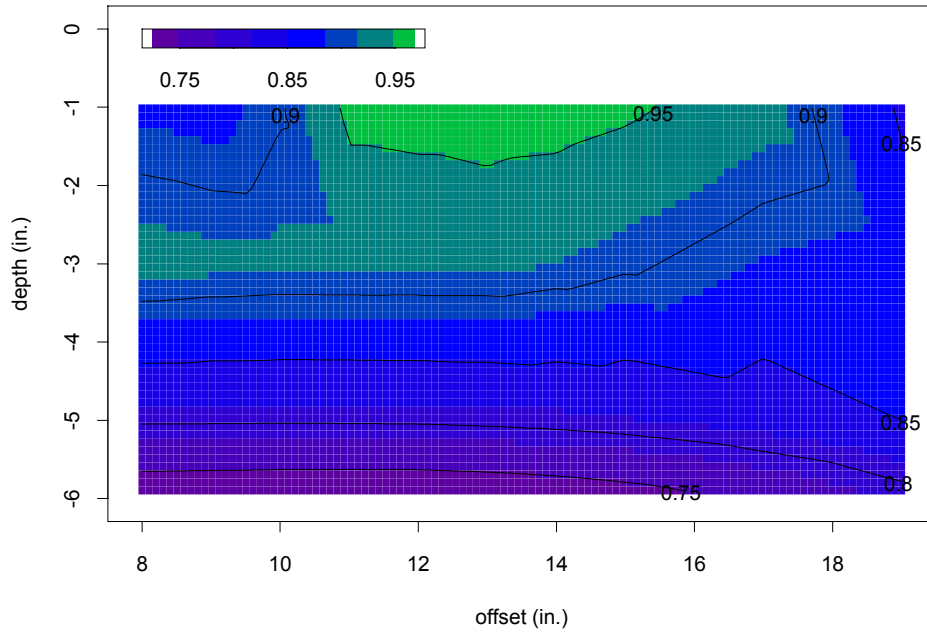

(a)

section 4: fine, AC=5.12, AV=6.6, C.F.=1.0 (no wander)

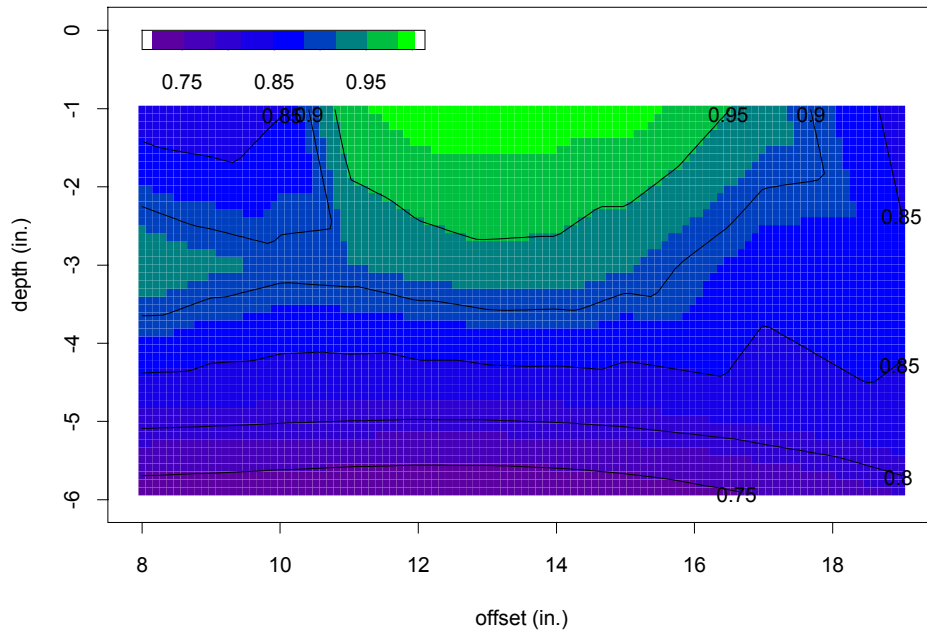

(b)

Figure B.7.3. Image-and-contour plots of SR of WesTrack Section 4 after 21,943 hours of simulation with a correction factor of 1.0: (a) wander and (b) no wander.

section 14: fine, AC=6.05, AV=9.0, C.F.=1.0 (wander)

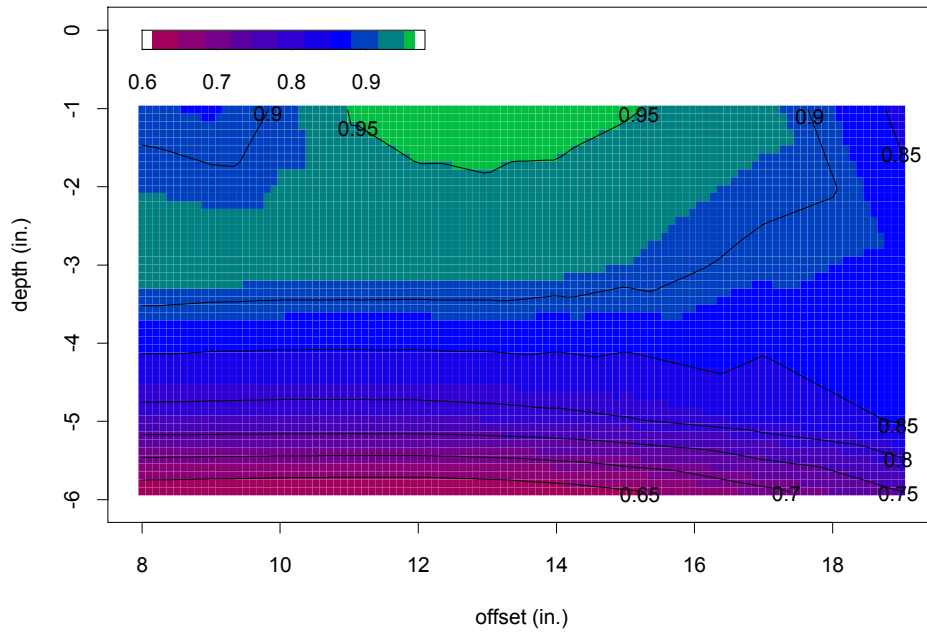

(a)

section 14: fine, AC=6.05, AV=9.0, C.F.=1.0 (no wander)

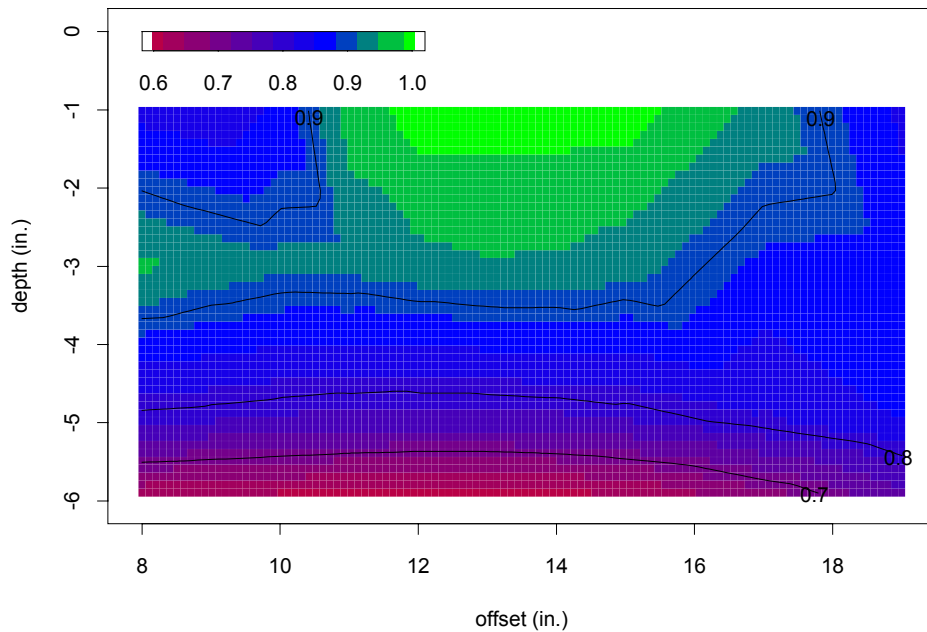

(b)

Figure B.7.4. Image-and-contour plots of SR of WesTrack Section 14 after 21,943 hours of simulation with a correction factor of 1.0: (a) wander and (b) no wander.

section 15: fine, AC=5.42, AV=8.7, C.F.=1.0 (wander)

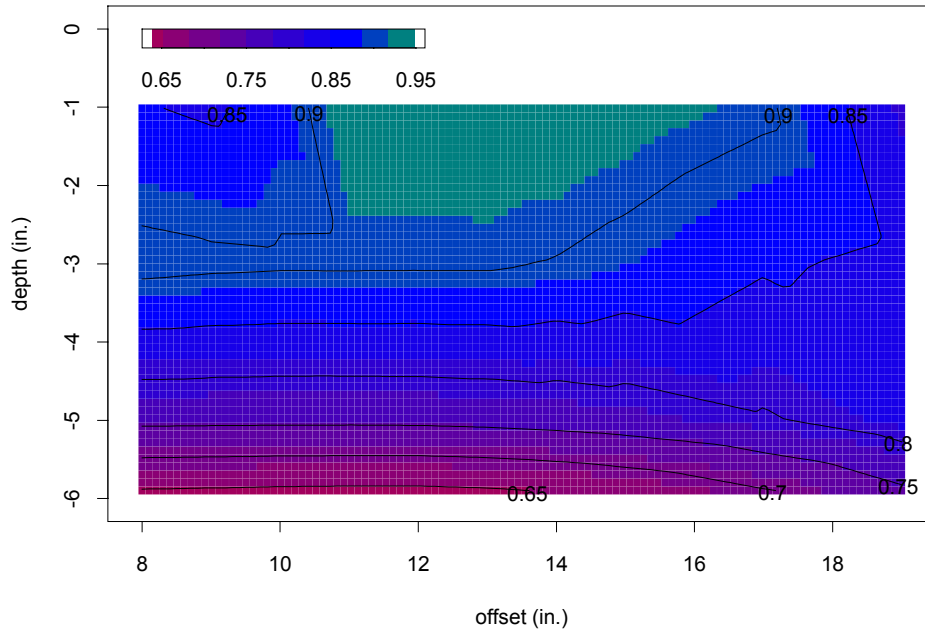

(a)

section 15: fine, AC=5.42, AV=8.7, C.F.=1.0 (no wander)

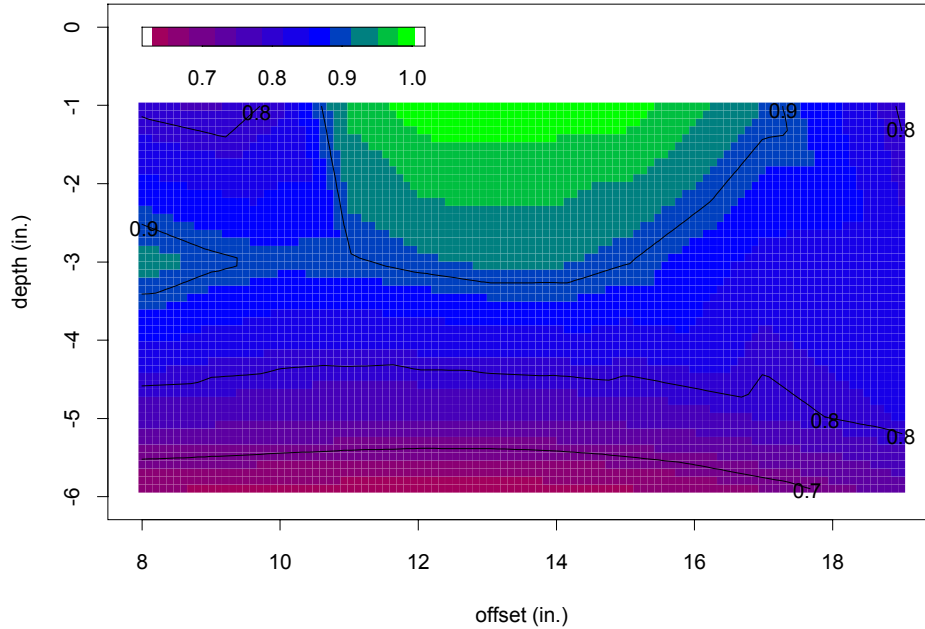

(b)

Figure B.7.5. Image-and-contour plots of SR of WesTrack Section 15 after 21,943 hours of simulation with a correction factor of 1.0: (a) wander and (b) no wander.

section 16: fine, AC=4.75, AV=12.2, C.F.=1.0 (wander)

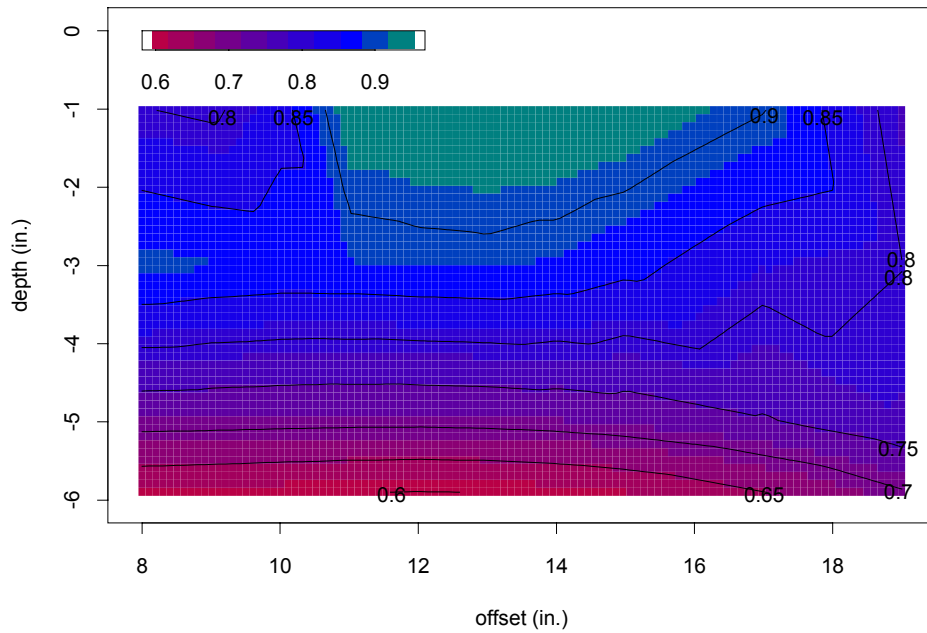

(a)

section 16: fine, AC=4.75, AV=12.2, C.F.=1.0 (no wander)

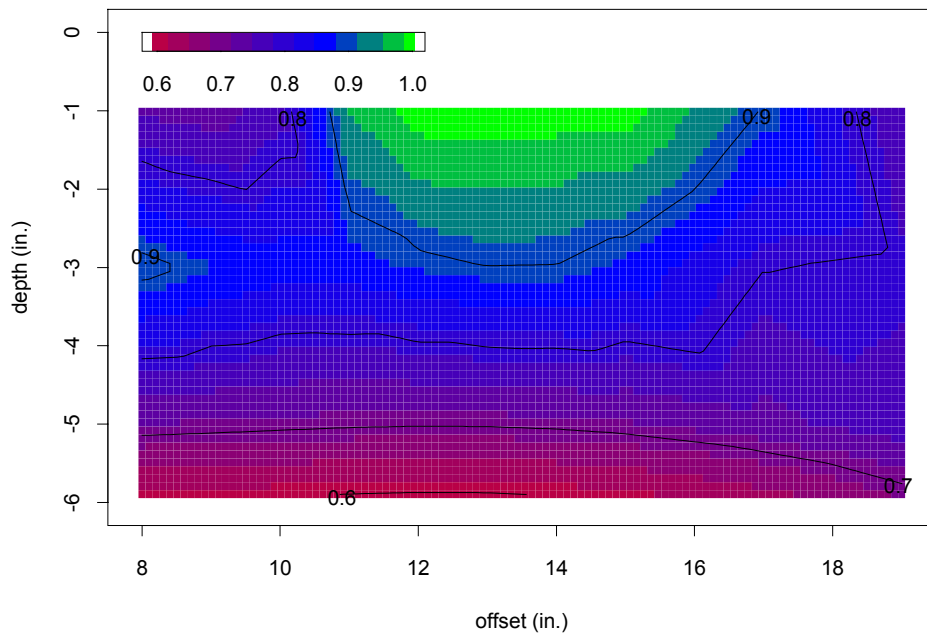

(b)

Figure B.7.6. Image-and-contour plots of SR of WesTrack Section 16 after 21,943 hours of simulation with a correction factor of 1.0: (a) wander and (b) no wander.

section 17: fine, AC=5.74, AV=11.0, C.F.=1.0 (wander)

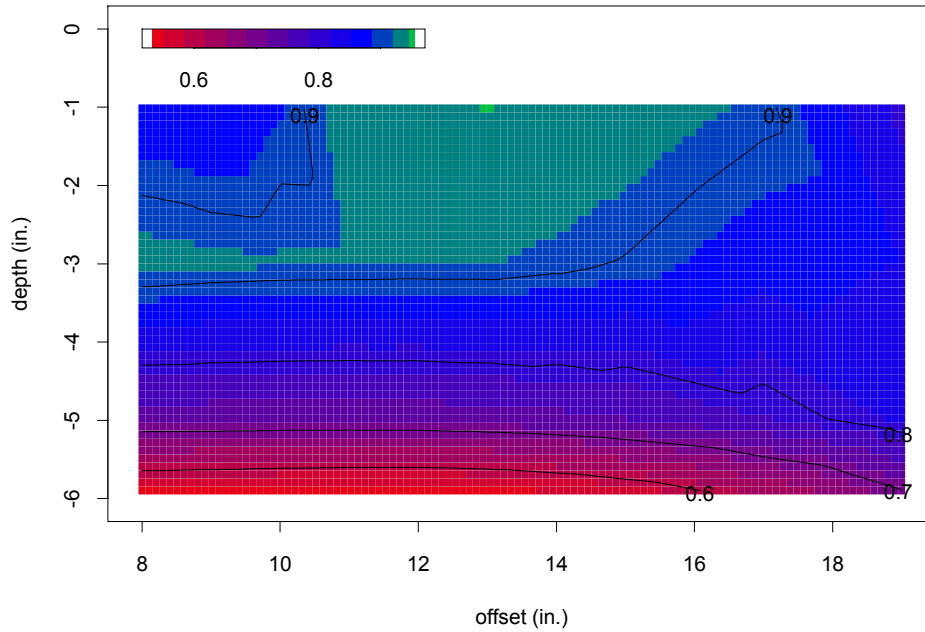

(a)

section 17: fine, AC=5.74, AV=11.0, C.F.=1.0 (no wander)

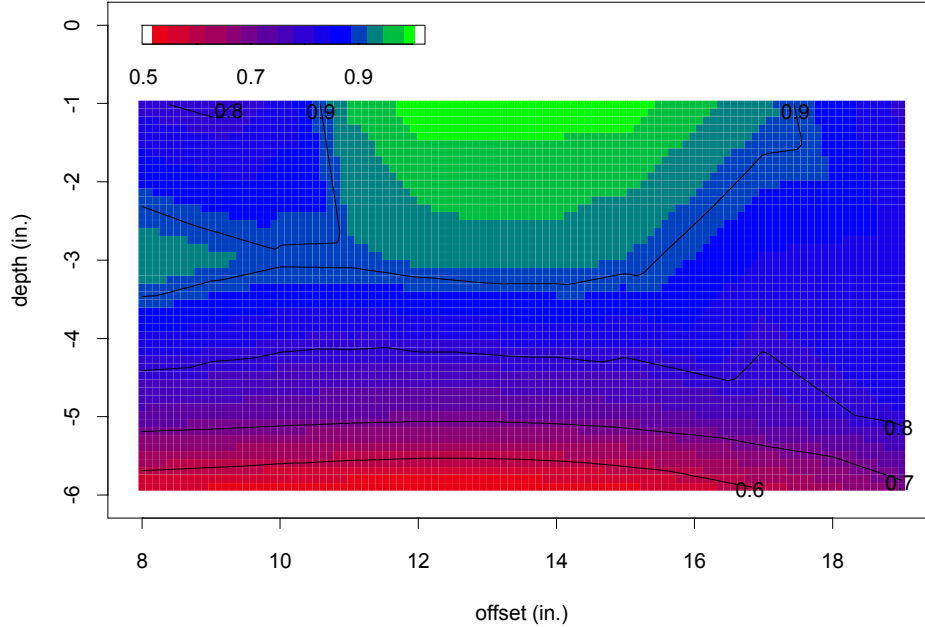

(b)

Figure B.7.7. Image-and-contour plots of SR of WesTrack Section 17 after 21,943 hours of simulation with a correction factor of 1.0: (a) wander and (b) no wander.

section 18: fine, AC=6.04, AV=4.3, C.F.=1.0 (wander)

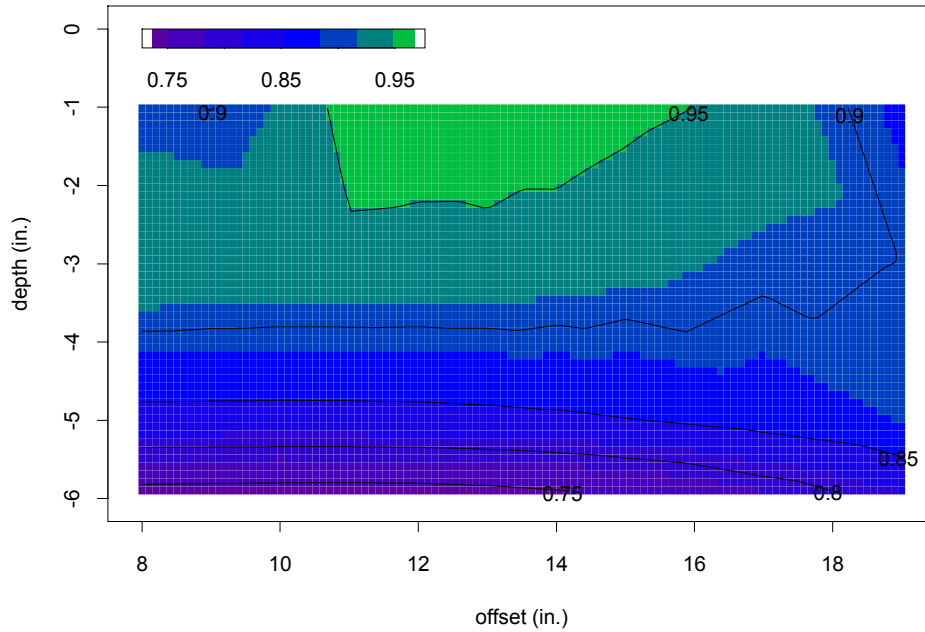

(a)

section 18: fine, AC=6.04, AV=4.3, C.F.=1.0 (no wander)

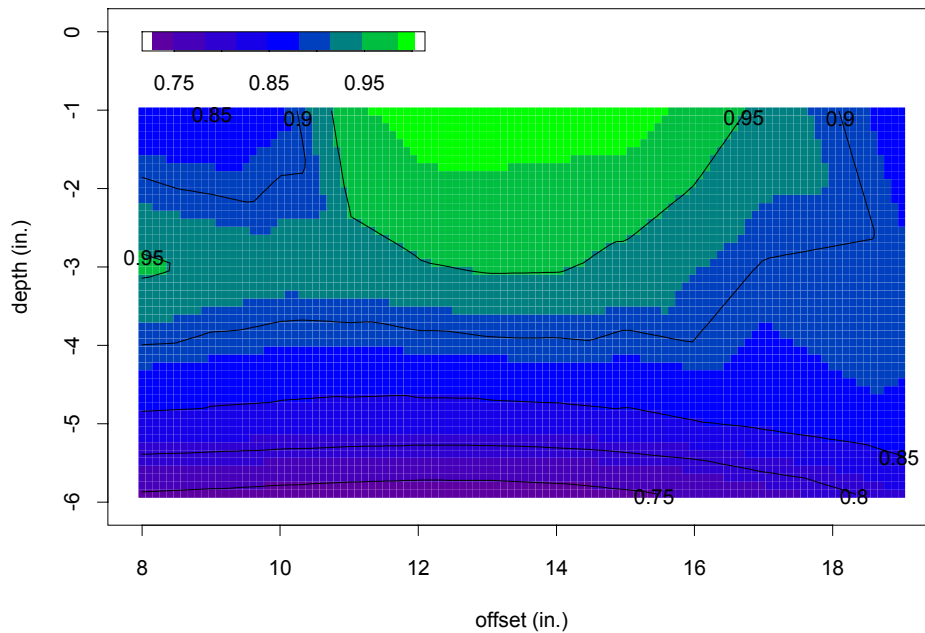

(b)

Figure B.7.8. Image-and-contour plots of SR of WesTrack Section 18 after 21,943 hours of simulation with a correction factor of 1.0: (a) wander and (b) no wander.

section 9: fine plus, AC=6.56, AV=3.9, C.F.=1.0 (wander)

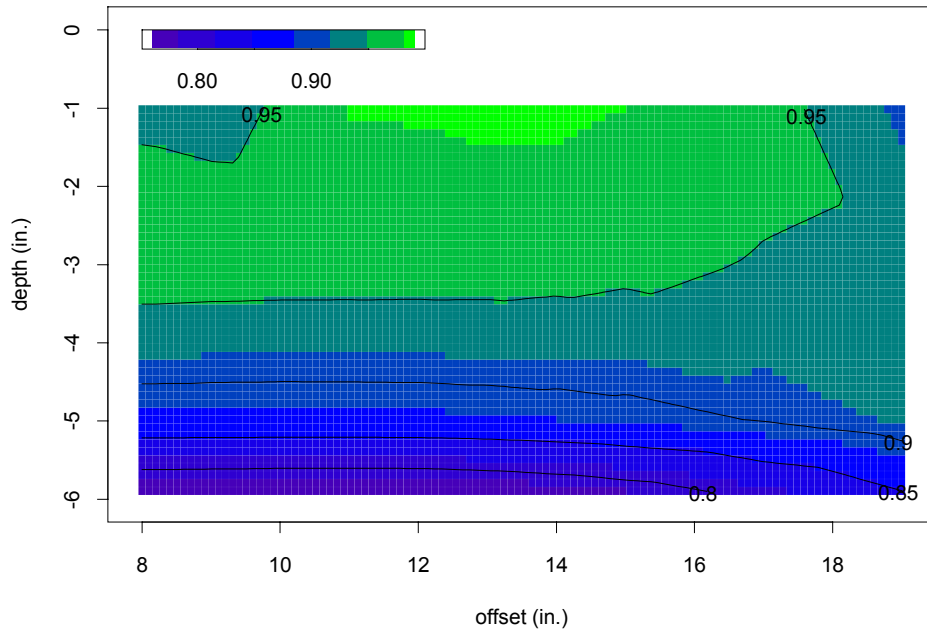

(a)

section 9: fine plus, AC=6.56, AV=3.9, C.F.=1.0 (no wander)

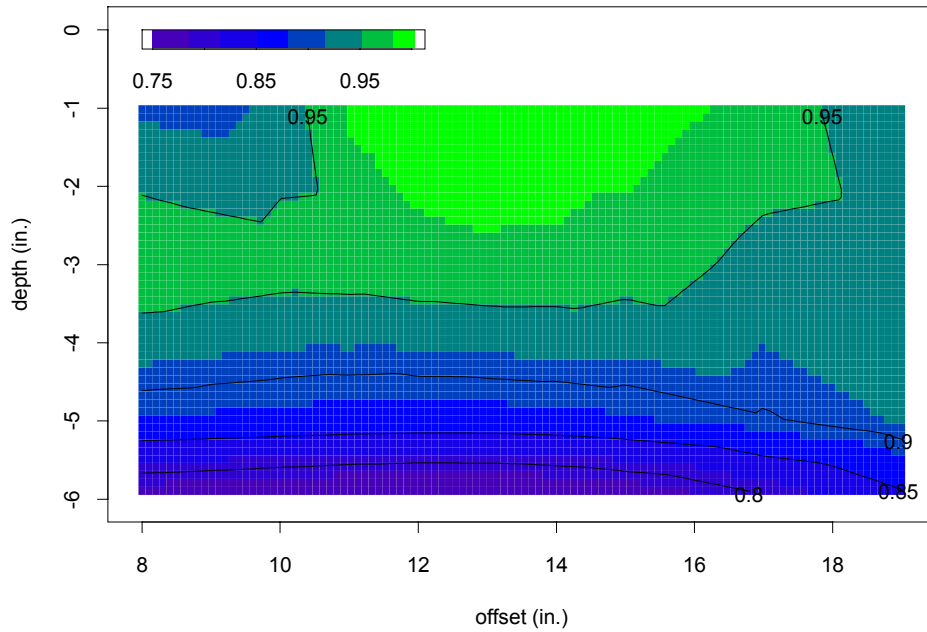

(b)

Figure B.7.9. Image-and-contour plots of SR of WesTrack Section 9 after 21,943 hours of simulation with a correction factor of 1.0: (a) wander and (b) no wander.

section 10: fine plus, AC=5.28, AV=11.8, C.F.=1.0 (wander)

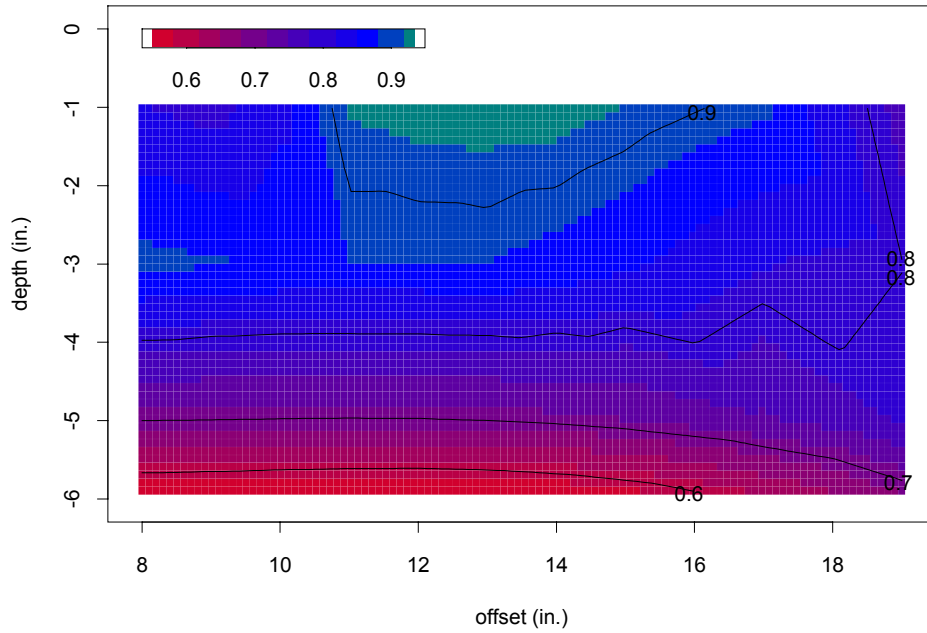

(a)

section 10: fine plus, AC=5.28, AV=11.8, C.F.=1.0 (no wander)

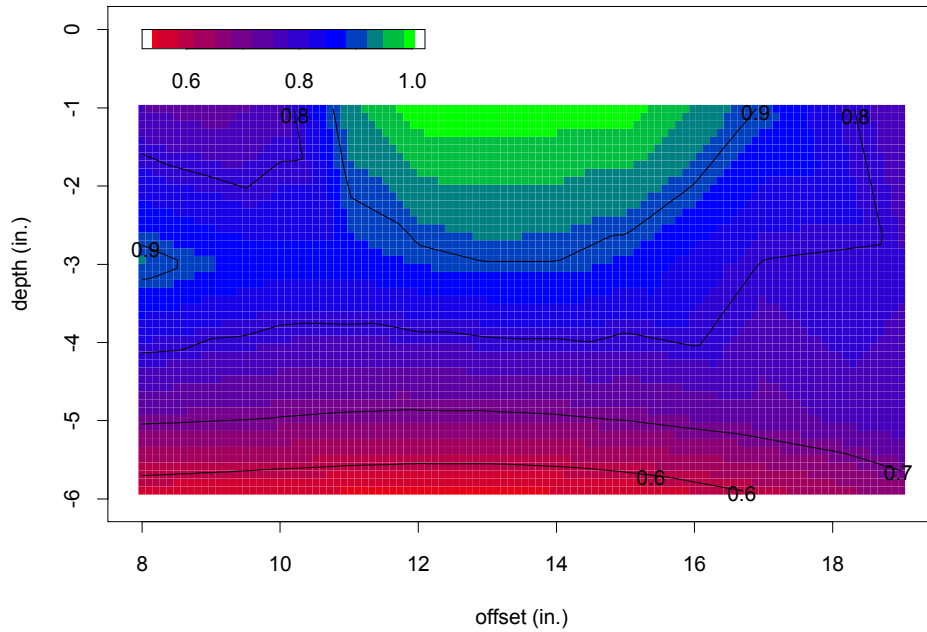

(b)

Figure B.7.10. Image-and-contour plots of SR of WesTrack Section 10 after 21,943 hours of simulation with a correction factor of 1.0: (a) wander and (b) no wander.

section 11: fine plus, AC=5.99, AV=7.9, C.F.=1.0 (wander)

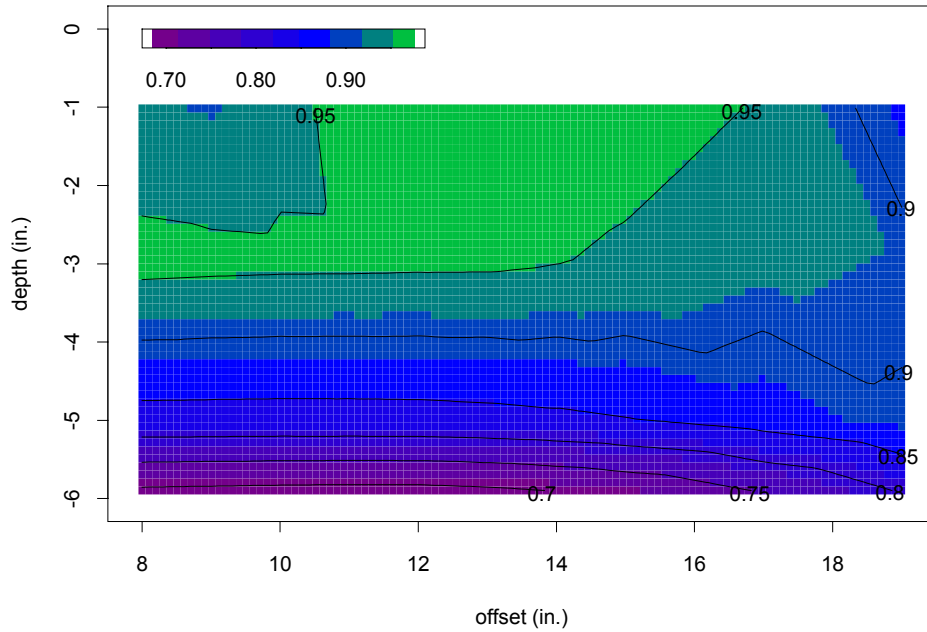

(a)

section 11: fine plus, AC=5.99, AV=7.9, C.F.=1.0 (no wander)

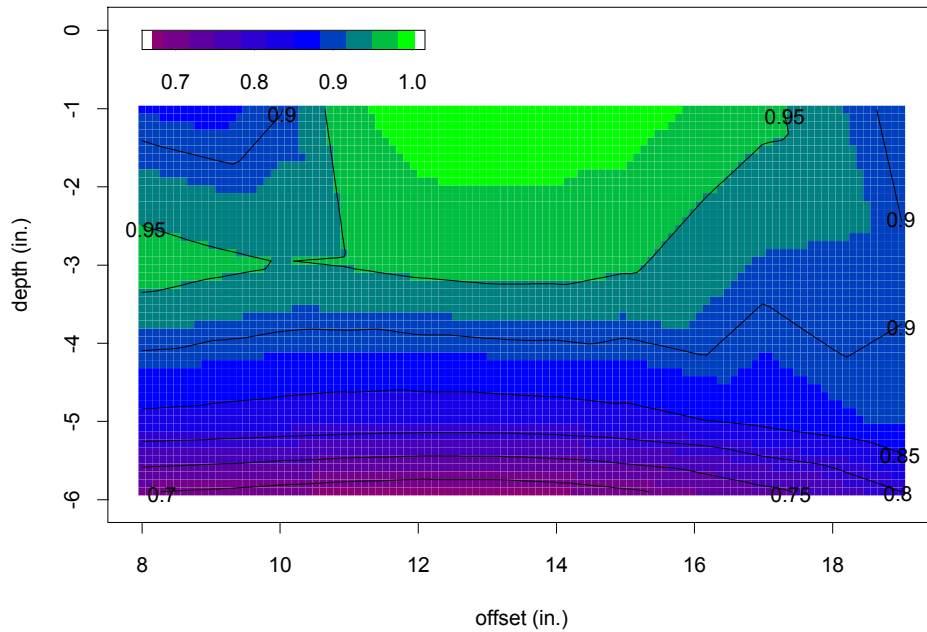

(b)

Figure B.7.11. Image-and-contour plots of SR of WesTrack Section 11 after 21,943 hours of simulation with a correction factor of 1.0: (a) wander and (b) no wander.

section 12: fine plus, AC=5.84, AV=4.6, C.F.=1.0 (wander)

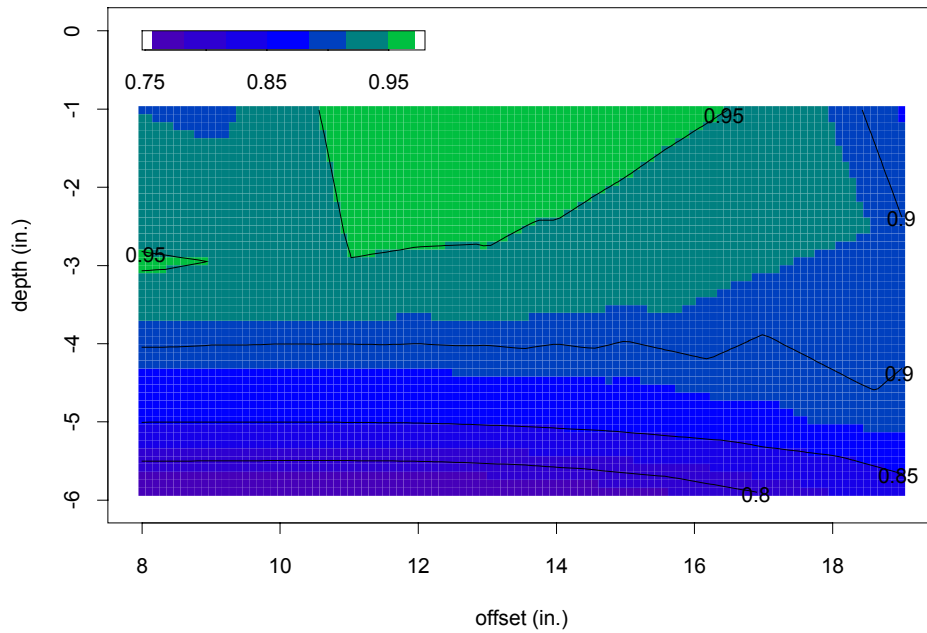

(a)

section 12: fine plus, AC=5.84, AV=4.6, C.F.=1.0 (no wander)

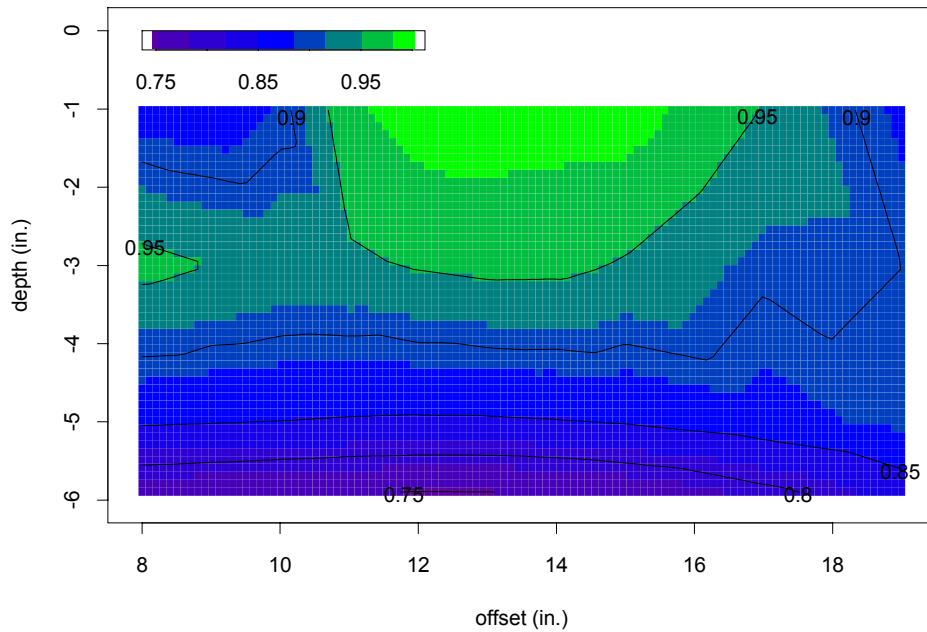

(b)

Figure B.7.12. Image-and-contour plots of SR of WesTrack Section 12 after 21,943 hours of simulation with a correction factor of 1.0: (a) wander and (b) no wander.

section 13: fine plus, AC=6.51, AV=5.9, C.F.=1.0 (wander)

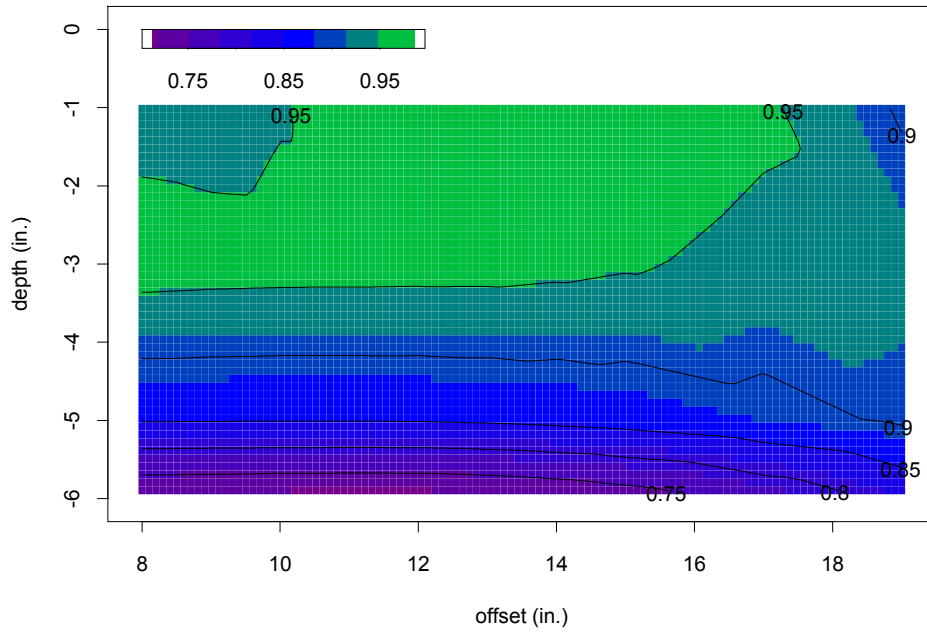

(a)

section 13: fine plus, AC=6.51, AV=5.9, C.F.=1.0 (no wander)

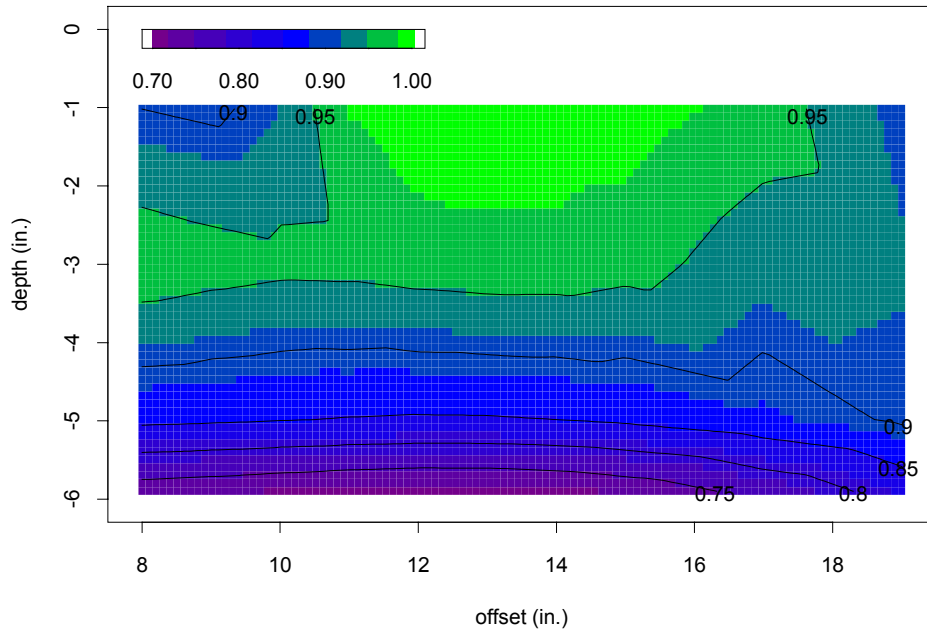

(b)

Figure B.7.13. Image-and-contour plots of SR of WesTrack Section 13 after 21,943 hours of simulation with a correction factor of 1.0: (a) wander and (b) no wander.

section 19: fine plus, AC=5.89, AV=7.2, C.F.=1.0 (wander)

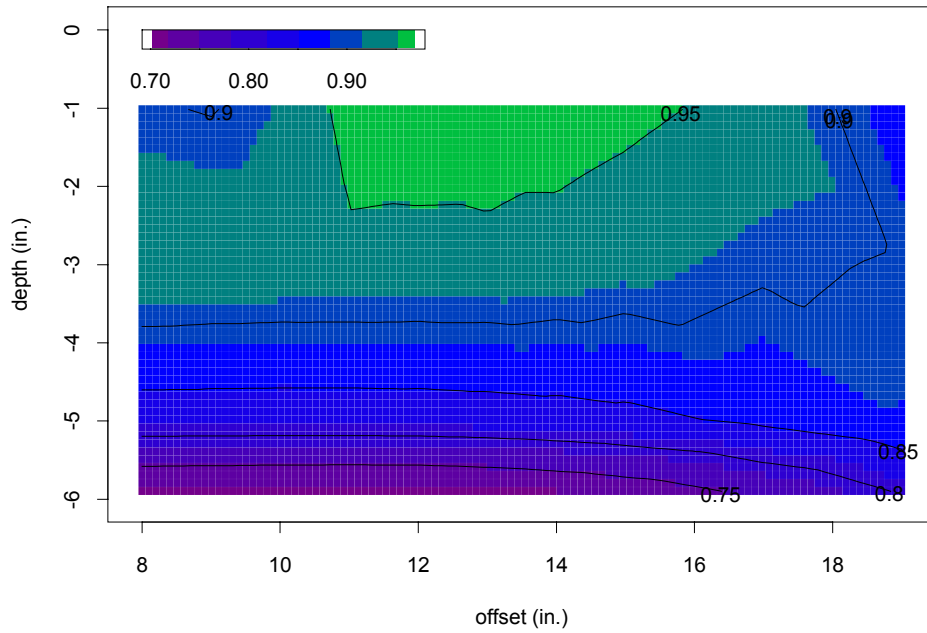

(a)

section 19: fine plus, AC=5.89, AV=7.2, C.F.=1.0 (no wander)

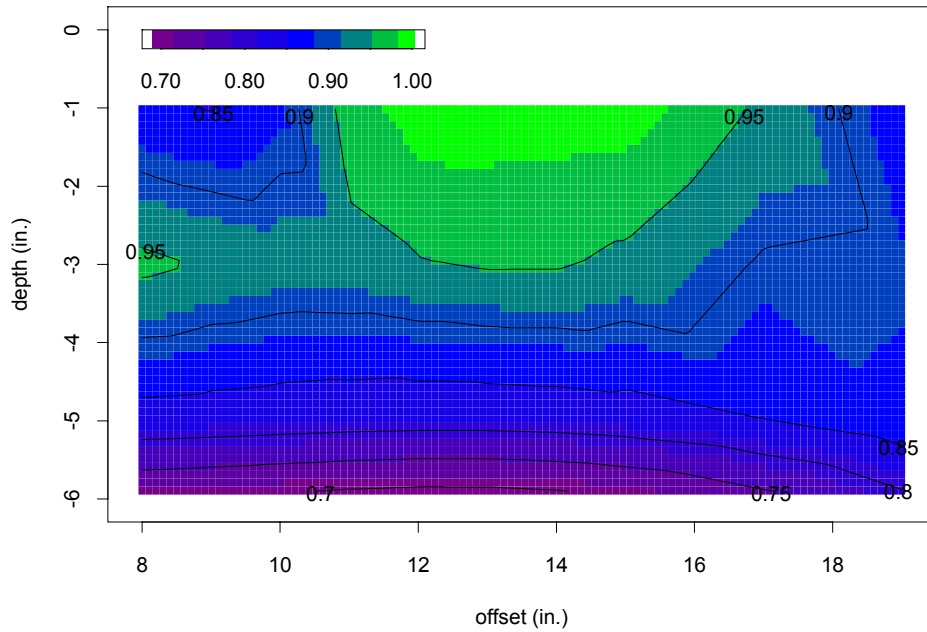

(b)

Figure B.7.14. Image-and-contour plots of SR of WesTrack Section 19 after 21,943 hours of simulation with a correction factor of 1.0: (a) wander and (b) no wander.

section 20: fine plus, AC=5.88, AV=10.9, C.F.=1.0 (wander)

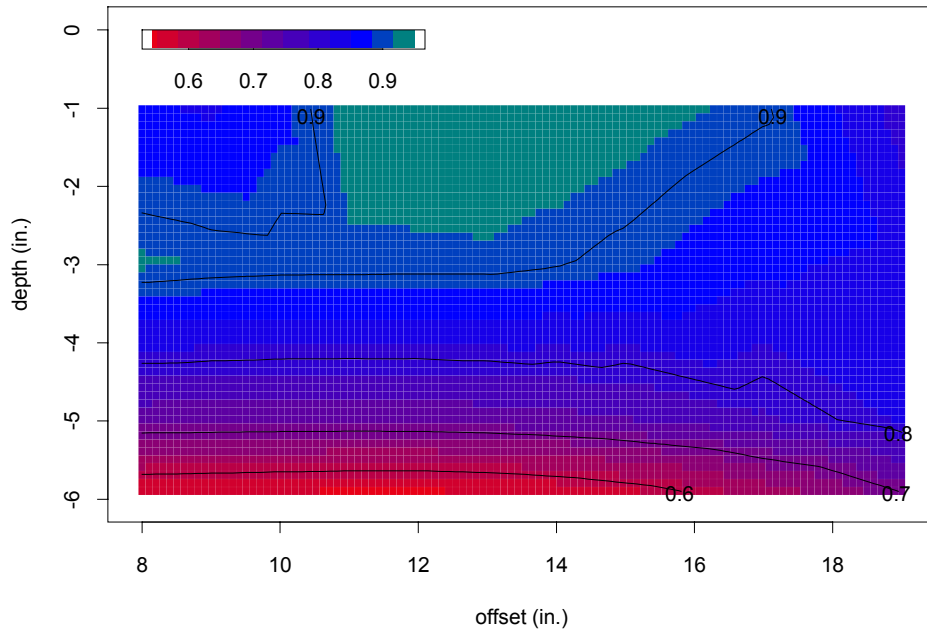

(a)

section 20: fine plus, AC=5.88, AV=10.9, C.F.=1.0 (no wander)

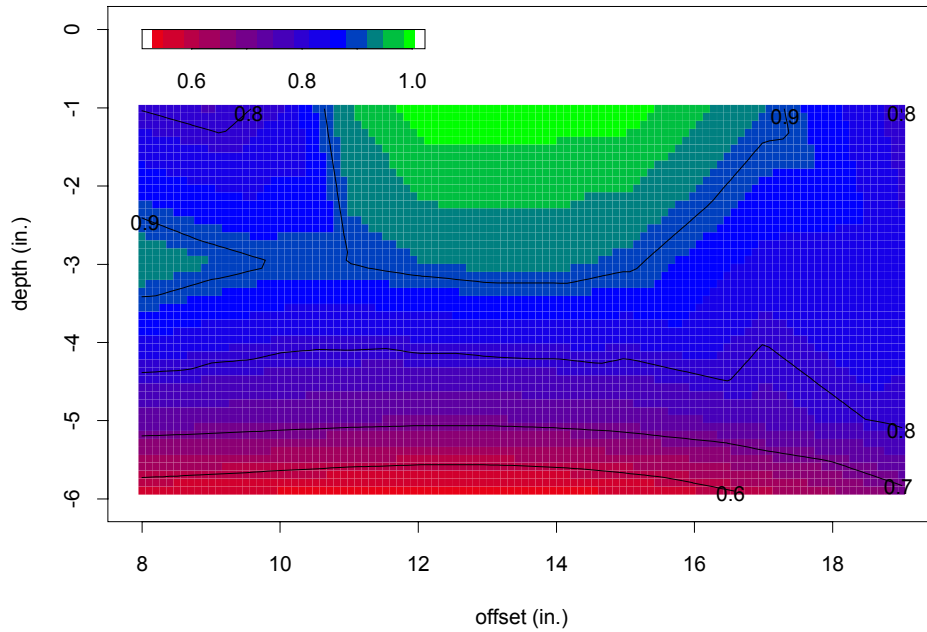

(b)

Figure B.7.15. Image-and-contour plots of SR of WesTrack Section 20 after 21,943 hours of simulation with a correction factor of 1.0: (a) wander and (b) no wander.

section 21: fine plus, AC=6.75, AV=4.2, C.F.=1.0 (wander)

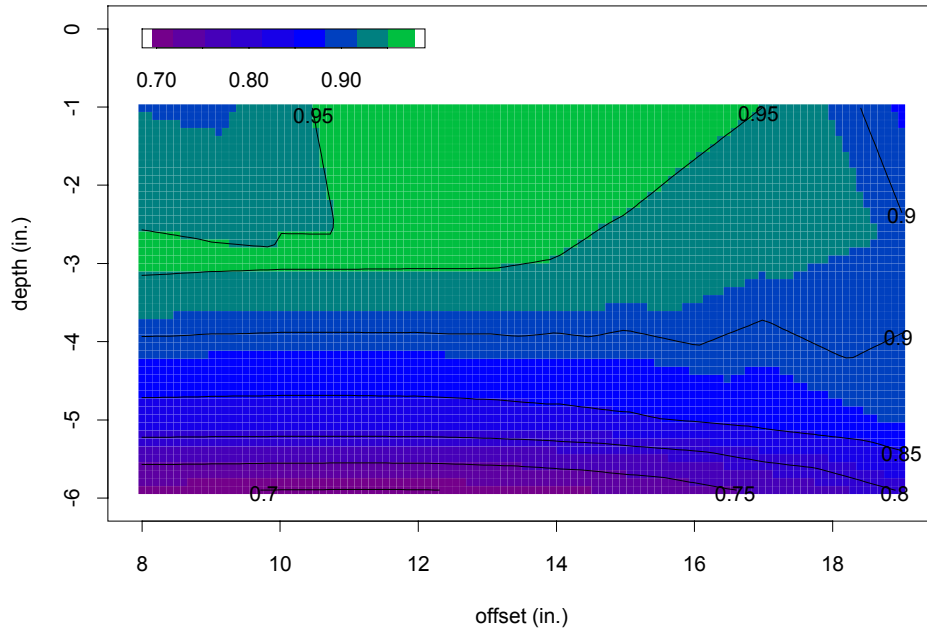

(a)

section 21: fine plus, AC=6.75, AV=4.2, C.F.=1.0 (no wander)

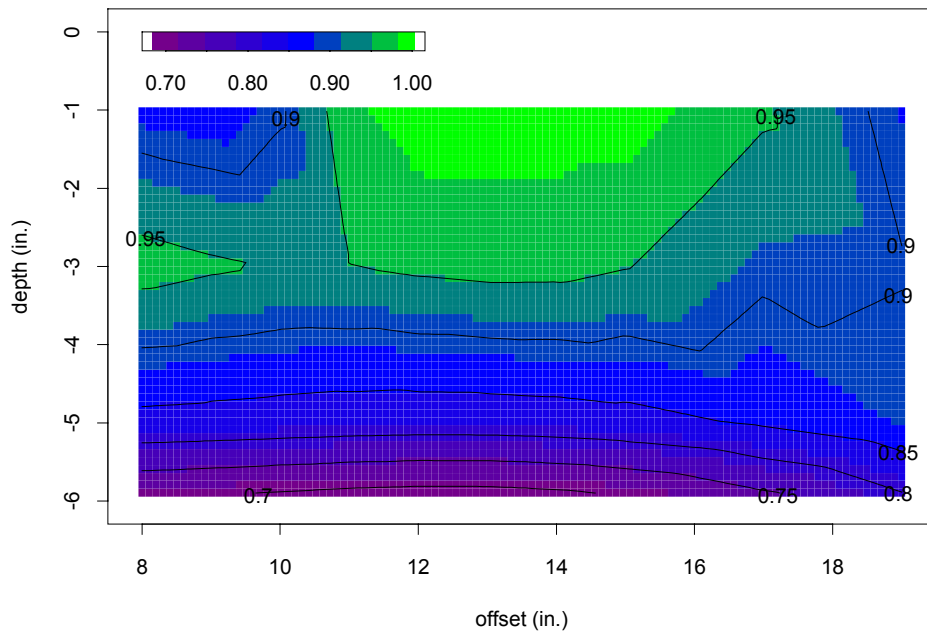

(b)

Figure B.7.16. Image-and-contour plots of SR of WesTrack Section 21 after 21,943 hours of simulation with a correction factor of 1.0: (a) wander and (b) no wander.

section 22: fine plus, AC=5.23, AV=8.1, C.F.=1.0 (wander)

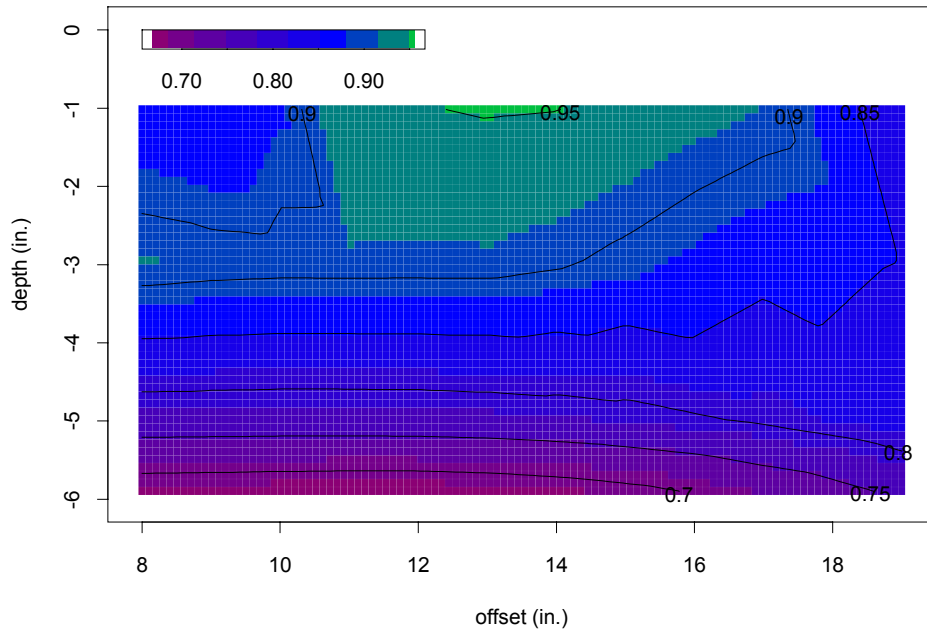

(a)

section 22: fine plus, AC=5.23, AV=8.1, C.F.=1.0 (no wander)

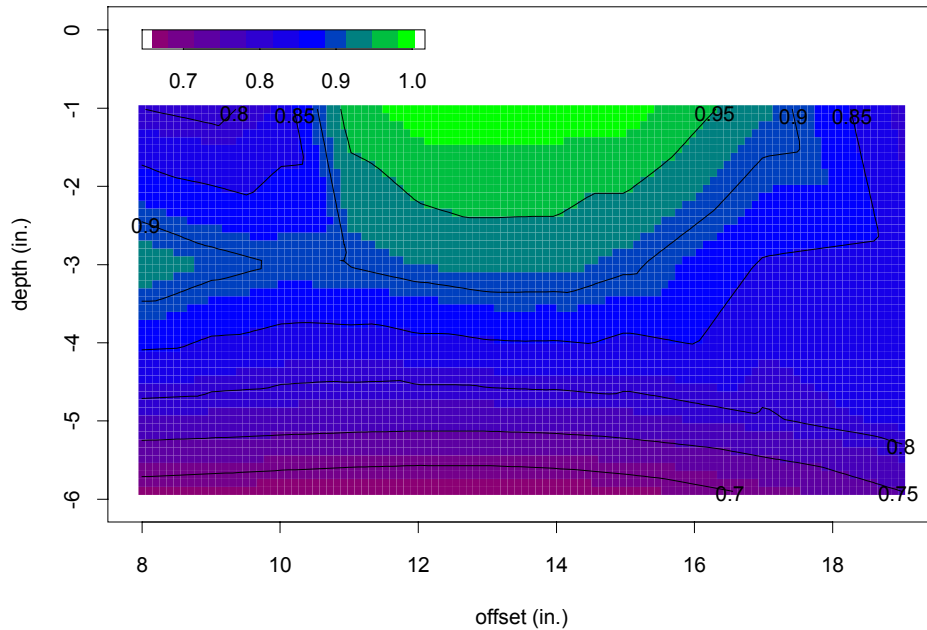

(b)

Figure B.7.17. Image-and-contour plots of SR of WesTrack Section 22 after 21,943 hours of simulation with a correction factor of 1.0: (a) wander and (b) no wander.

section 5: coarse, AC=5.63, AV=8.1, C.F.=1.0 (wander)

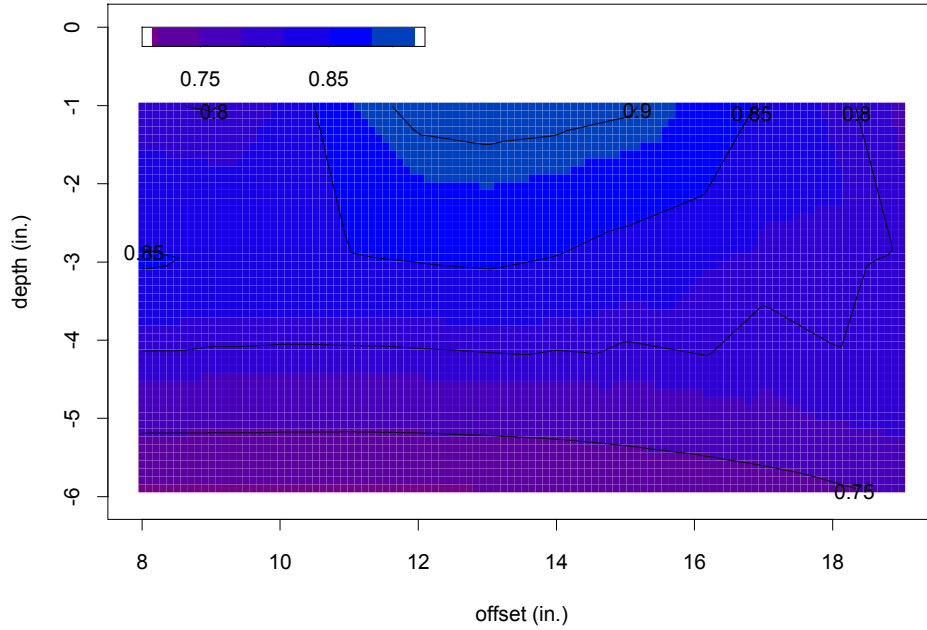

(a)

section 5: coarse, AC=5.63, AV=8.1, C.F.=1.0 (no wander)

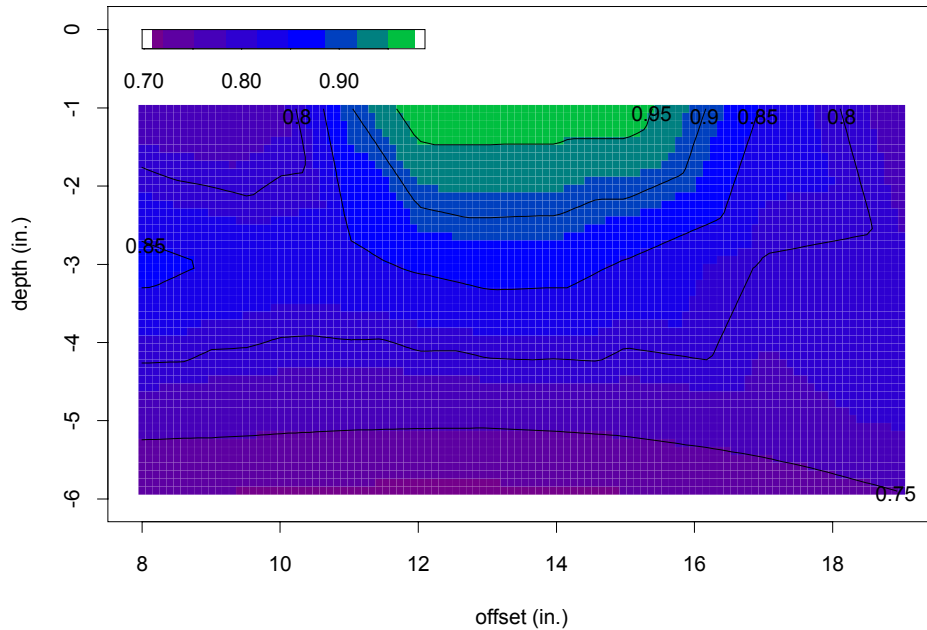

(b)

Figure B.7.18. Image-and-contour plots of SR of WesTrack Section 5 after 21,943 hours of simulation with a correction factor of 1.0: (a) wander and (b) no wander.

section 6: coarse, AC=5.71, AV=10.8, C.F.=1.0 (wander)

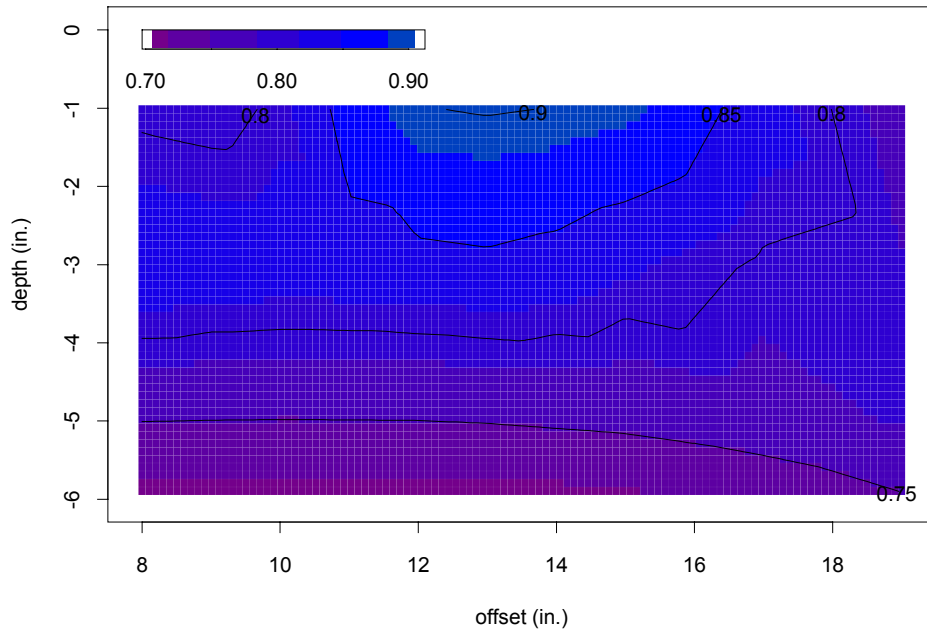

(a)

section 6: coarse, AC=5.71, AV=10.8, C.F.=1.0 (no wander)

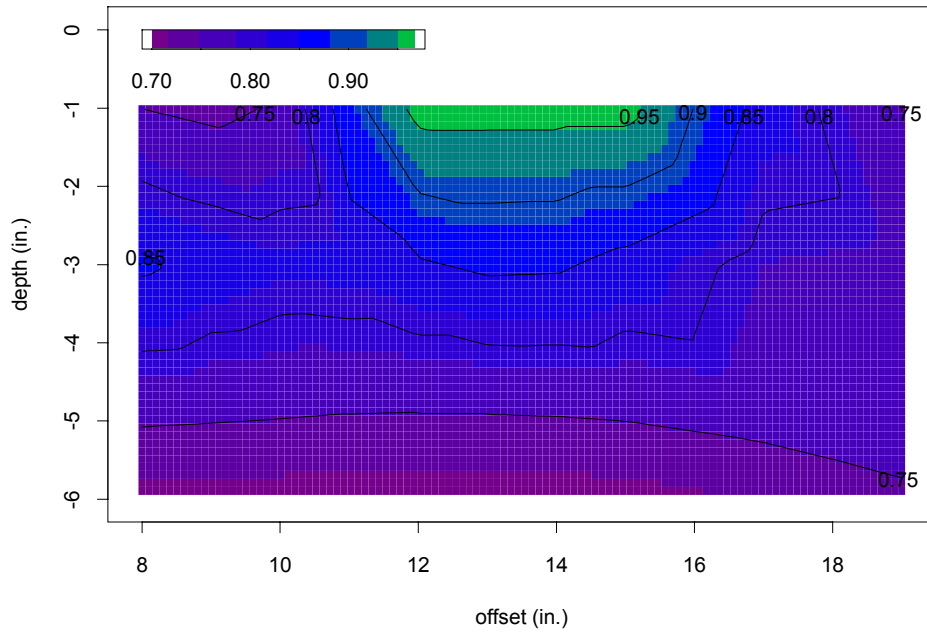

(b)

Figure B.7.19. Image-and-contour plots of SR of WesTrack Section 6 after 21,943 hours of simulation with a correction factor of 1.0: (a) wander and (b) no wander.

section 7: coarse, AC=6.49, AV=6.9, C.F.=1.0 (wander)

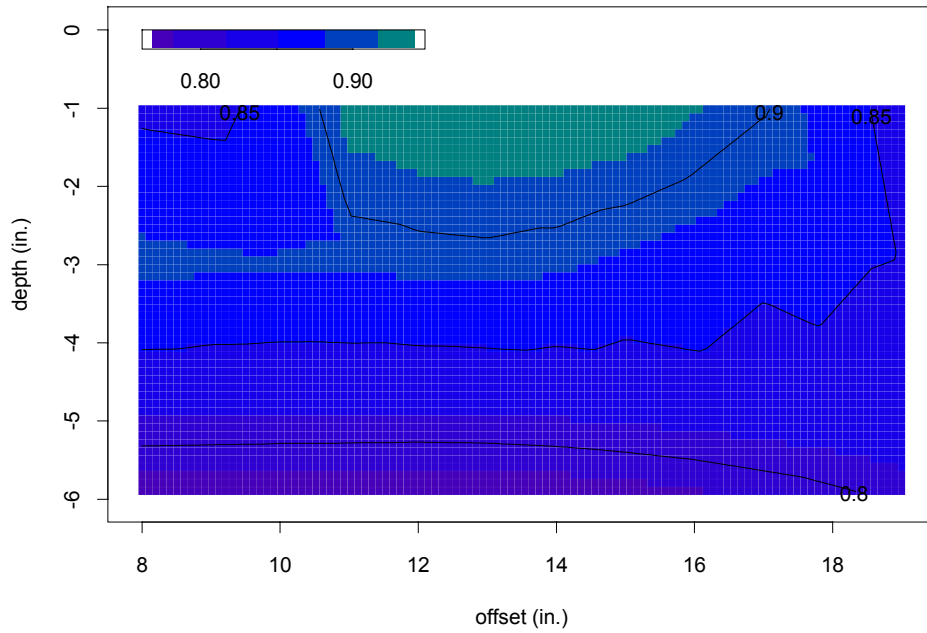

(a)

section 7: coarse, AC=6.49, AV=6.9, C.F.=1.0 (no wander)

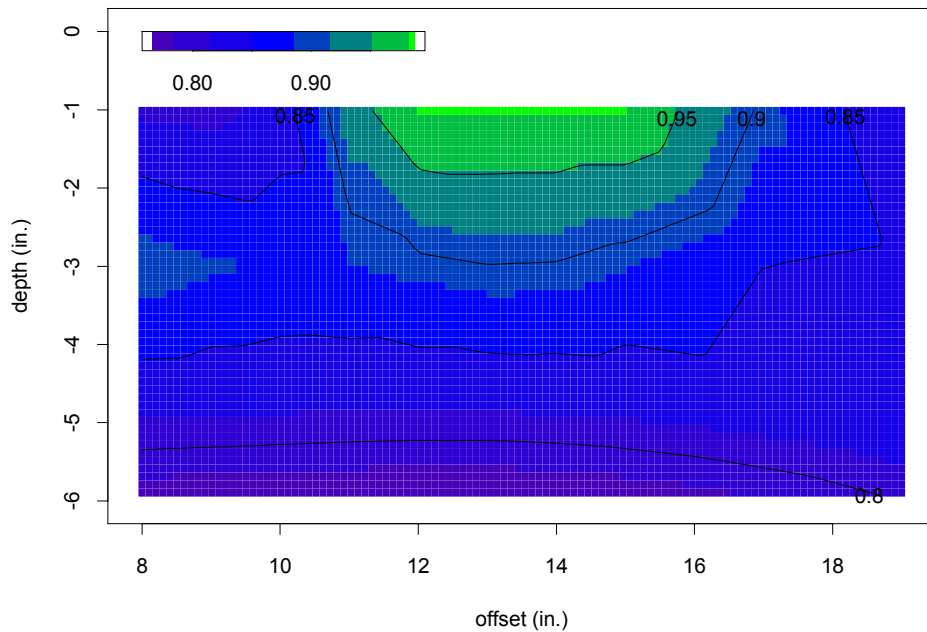

(b)

Figure B.7.20. Image-and-contour plots of SR of WesTrack Section 7 after 21,943 hours of simulation with a correction factor of 1.0: (a) wander and (b) no wander.

section 23: coarse, AC=5.79, AV=4.9, C.F.=1.0 (wander)

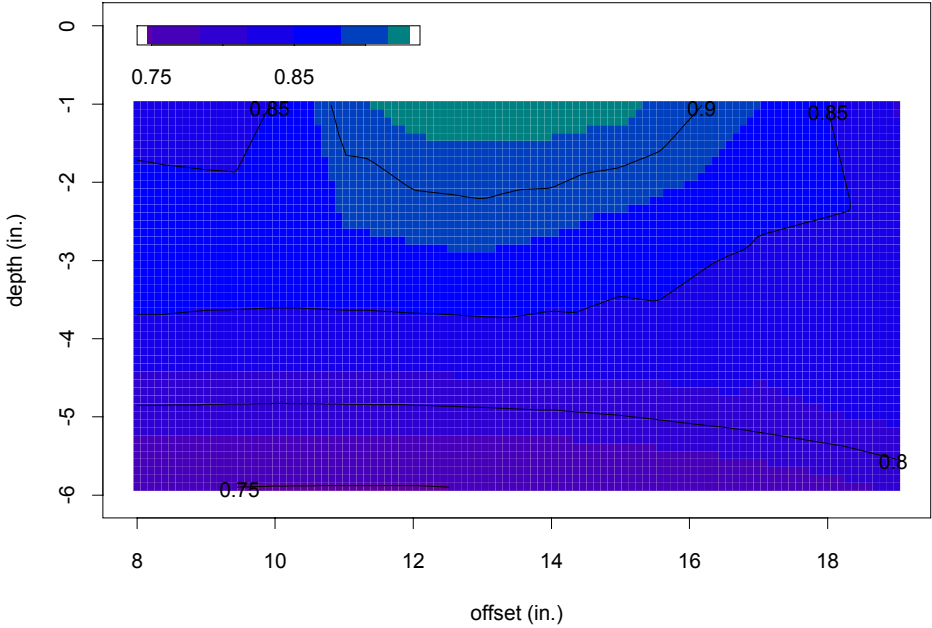

(a)

section 23: coarse, AC=5.79, AV=4.9, C.F.=1.0 (no wander)

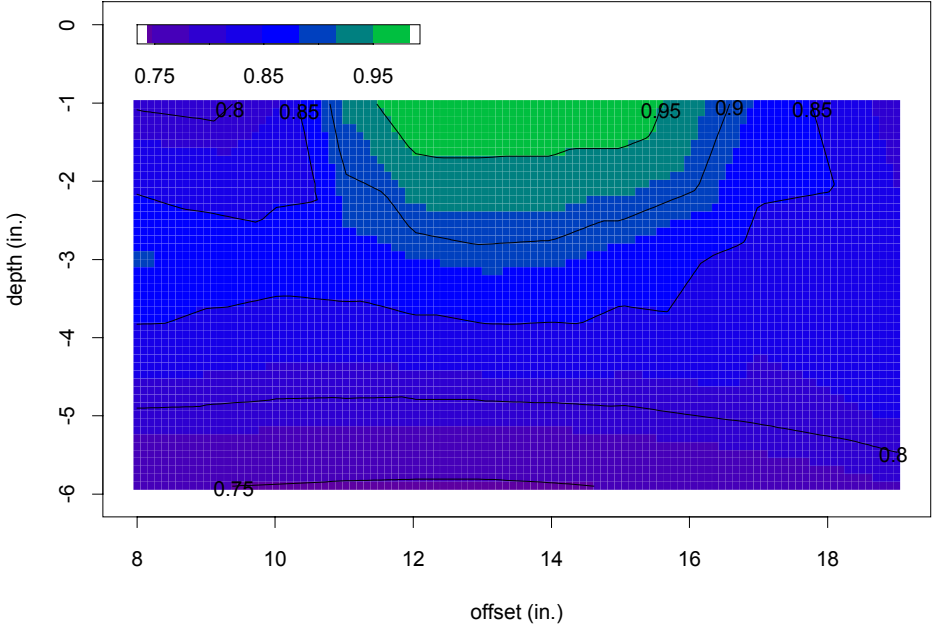

(b)

Figure B.7.21. Image-and-contour plots of SR of WesTrack Section 23 after 21,943 hours of simulation with a correction factor of 1.0: (a) wander and (b) no wander.

section 24: coarse, AC=5.94, AV=7.2, C.F.=1.0 (wander)

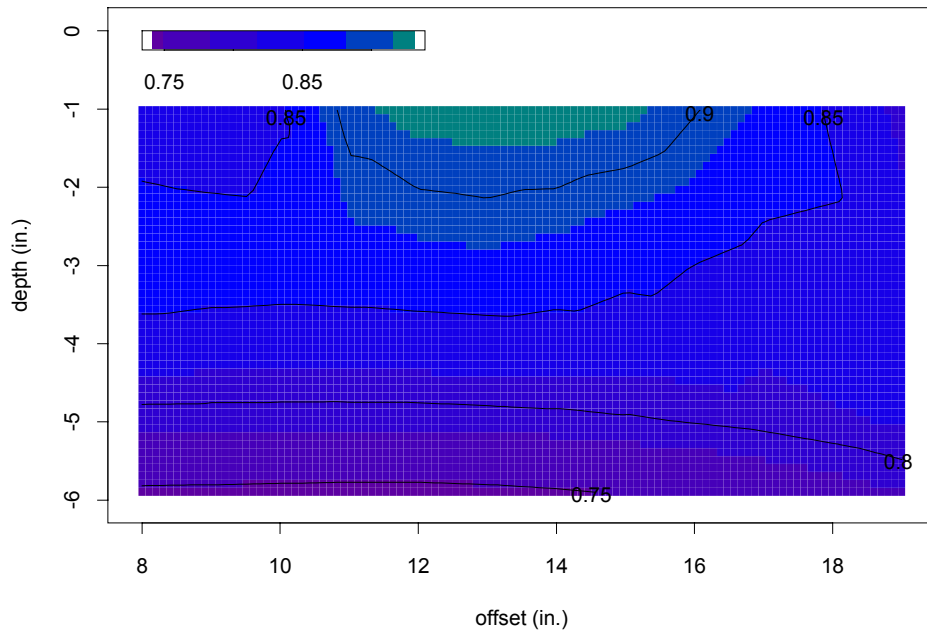

(a)

section 24: coarse, AC=5.94, AV=7.2, C.F.=1.0 (no wander)

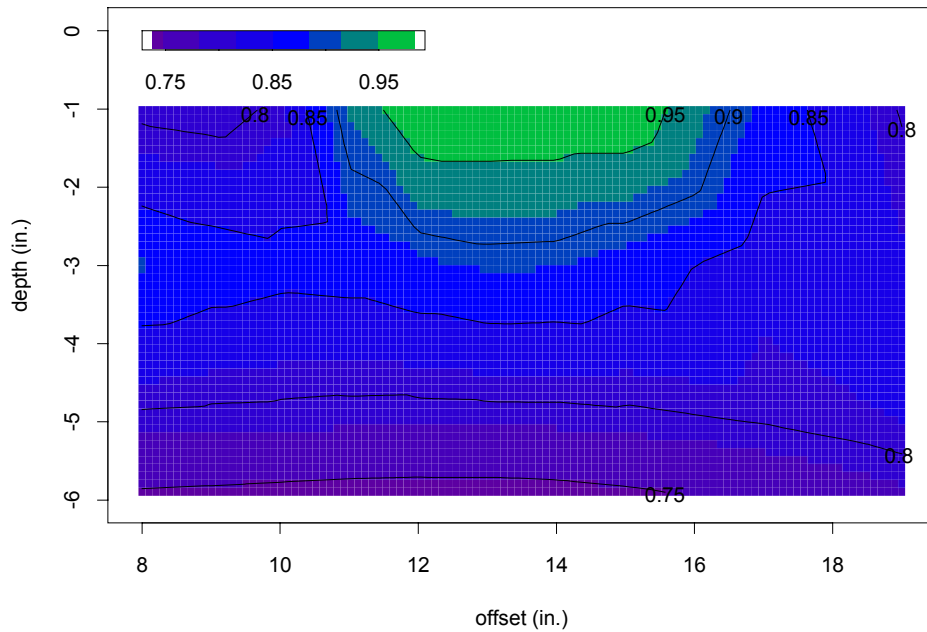

(b)

Figure B.7.22. Image-and-contour plots of SR of WesTrack Section 24 after 21,943 hours of simulation with a correction factor of 1.0: (a) wander and (b) no wander.

section 25: coarse, AC=6.55, AV=3.7, C.F.=1.0 (wander)

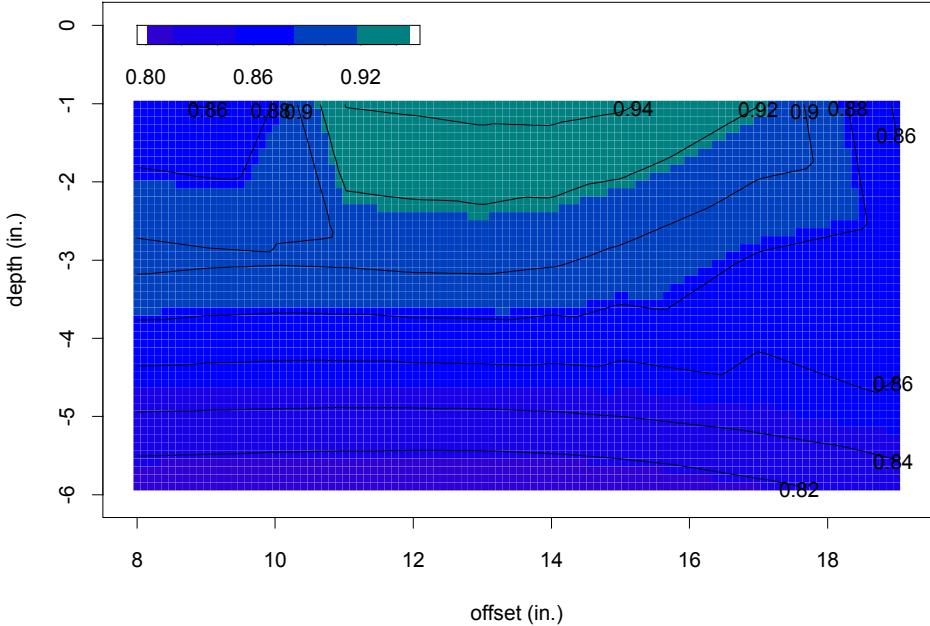

(a)

section 25: coarse, AC=6.55, AV=3.7, C.F.=1.0 (no wander)

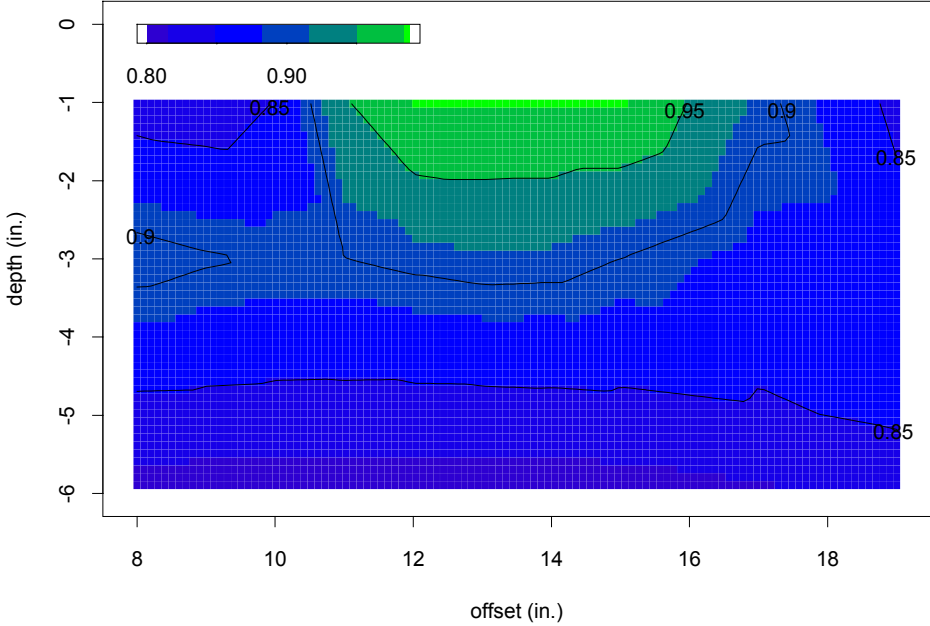

(b)

Figure B.7.23. Image-and-contour plots of SR of WesTrack Section 25 after 21,943 hours of simulation with a correction factor of 1.0: (a) wander and (b) no wander.

section 26: coarse, AC=5.31, AV=11.0, C.F.=1.0 (wander)

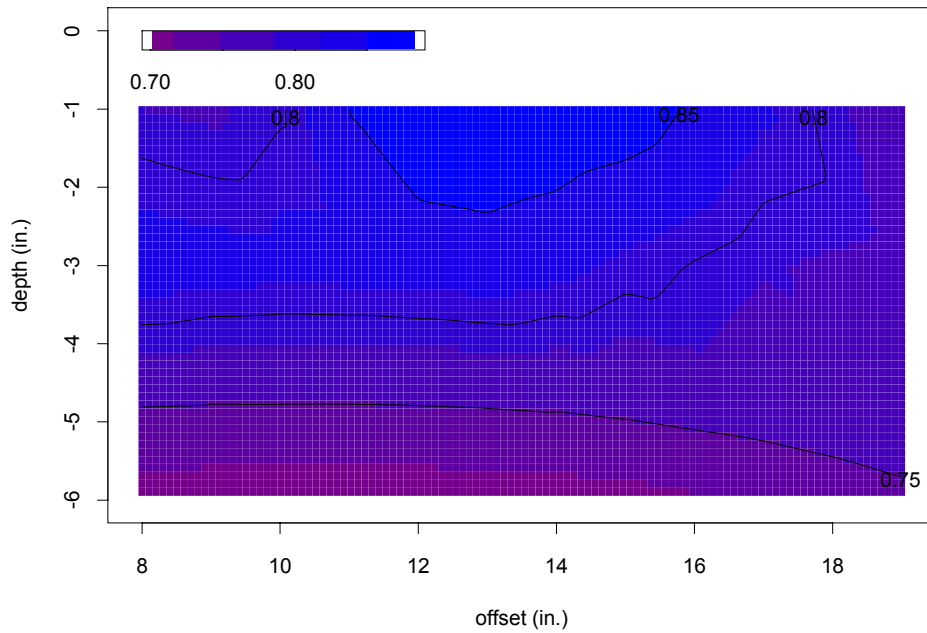

(a)

section 26: coarse, AC=5.31, AV=11.0, C.F.=1.0 (no wander)

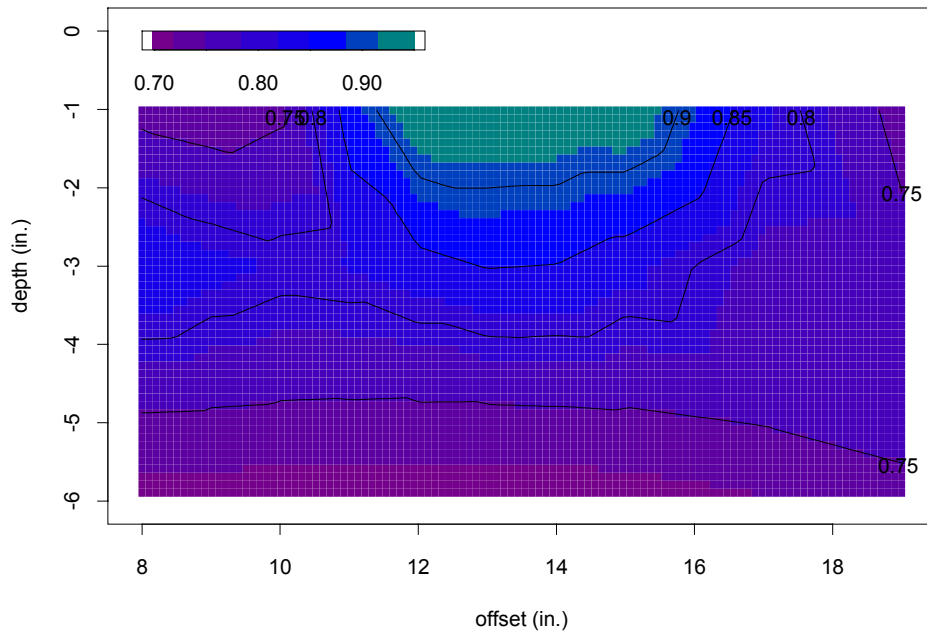

(b)

Figure B.7.24. Image-and-contour plots of SR of WesTrack Section 26 after 21,943 hours of simulation with a correction factor of 1.0: (a) wander and (b) no wander.

APPENDIX C: FLEXURAL BEAM ANALYSIS AND S-PLUS CODE FOR CHAPTER 4

C.1. Flexural Beam Analysis Using Strain Gage Data

C.1.1. Analysis without Aluminum Support

Instead of using the conventional measurements of flexural beam tests, i.e., load cell and LVDT readings, this analysis utilizes the measurements from strain gages, which were attached to the top and bottom of an asphalt concrete beam and located along the longitudinal midpoint of the beam. The main advantages to utilizing strain gage measurements are to (1) verify the feasibility of applying linear elastic theory to asphalt concrete beams especially as subjected to high temperatures, (2) validate if asphalt concrete exhibits a nonlinear or bilinear stress-strain relationship at high temperatures, and (3) perform a genuine controlled-strain flexural beam test.

Two assumptions are postulated below for analysis:

1. Plane remains plane so that, at any given time, the strains vary linearly through the depth of the beam.
2. The stress-strain diagram consists of two straight lines. The modulus of elasticity in tension is E_1 and in compression is E_2 .

According to the above assumptions, the position of the neutral axis on a rectangular beam with height h and width b , as illustrated in Figure C.1a, can then be obtained with the following equations (Gere and Timoshenko P.540):

$$h_1 = \frac{h\sqrt{E_2}}{\sqrt{E_1} + \sqrt{E_2}}, \quad h_2 = \frac{h\sqrt{E_1}}{\sqrt{E_1} + \sqrt{E_2}} \quad (1)$$

Assuming E_1 is a proportion of E_2 , i.e., $E_2 = KE_1$, then according to the “plane remains plane” assumption shown in Figure C.1c, the following equation should hold true:

$$\frac{|\varepsilon_1|}{|\varepsilon_2|} = \frac{h_1}{h_2} \quad (2)$$

$$\frac{|\varepsilon_1|}{|\varepsilon_1| + |\varepsilon_2|} = \frac{h_1}{h_1 + h_2} = \frac{h_1}{h} = \frac{\sqrt{KE_1}}{\sqrt{E_1} + \sqrt{KE_1}} = \frac{\sqrt{K}}{1 + \sqrt{K}}$$

Denote $\frac{|\varepsilon_1|}{|\varepsilon_1| + |\varepsilon_2|}$ as ε_R . Then, from the above equation, the relationship of coefficient K and ε_R can be expressed as

$$K = \left(\frac{\varepsilon_R}{1 - \varepsilon_R} \right)^2 \quad (3)$$

Thus, from the corresponding strain gage measurements, the K can be easily calculated. Note that if the material has the same modulus in tension and compression (i.e., $K = 1$), then from Equation 3, the $\varepsilon_R = 1/2$. In other words, the extreme tensile strain should be equivalent to the extreme compressive strain and the neutral axis should be located in the middle height of the beam. The location of the neutral axis can be obtained from the measurements of the strain gages attached to the asphalt concrete by utilizing Equation 2.

To find the tensile modulus, consider the moment with respect to the point O in Figure C.1d. Then, the moment equilibrium equation can be summarized as

$$\begin{aligned} \sigma_1 &= E_1 \varepsilon_1 & \sigma_2 &= E_2 \varepsilon_2 \\ T_1 &= \frac{1}{2} \sigma_2 h_2 b = \frac{1}{2} E_2 \varepsilon_2 h_2 b \\ C_1 &= \frac{1}{2} \sigma_1 h_1 b = \frac{1}{2} E_1 \varepsilon_1 h_1 b \\ T_1 \cdot \frac{1}{3} h_2 &= pl + C_1 \cdot \left(h_2 + \frac{2}{3} h_1 \right) \end{aligned} \quad (4)$$

From Equation 2, h_1 and h_2 can be obtained from the strain gage measurements. The coefficient K can be obtained from Equation 3. By plugging in all the known relationships, Equation 4 can be expressed as a determinate function of E_1 and solved easily.

C.1.2 Analysis with Aluminum Support

The basic idea behind placing an aluminum plate with a TEFLON™ sheet as a frictionless interface underneath an asphalt concrete beam is to prevent creeping of the beam during the installation and testing while subjected to high temperatures.

Assumption:

1. A thin TEFLON™ sheet is placed between the asphalt concrete and the aluminum plate. It is intended to serve as a “frictionless” layer between the two. The stress distribution along the cross section of TEFLON™ sheet was dismissed as negligible and the friction forces between interfaces were eliminated when taking the moment equilibrium because the friction forces appear in pairs and in opposite direction, thus canceling themselves out.

This assumption, as well as the assumptions mentioned in previous paragraphs, i.e., that the “plane remains plane” and “there exist different tensile and compressive moduli of asphalt concrete,” still hold up in this analysis. Under the “frictionless TEFLON™” assumption, the theoretical strain distribution along this compound material setup should be like as is shown in Figure C.2b. However, it was found that the stress and strain distribution can also be shown as in Figure C.2c. The corresponding stress distributions are illustrated in Figures C.2d and C.2e respectively. These phenomena are discussed separately in the following paragraphs.

Recall that the main purpose of this analysis is to determine the tensile flexural stiffness of asphalt concrete at any instant during a high temperature fatigue test. Although it has been recognized that the asphalt concrete could behave viscoelastically at high temperatures, it is considered appropriate to treat the material as an elastic solid at any instant, containing various tensile and compressive moduli at high temperature. Put another way, even if the asphalt concrete does behave like a viscoelastic material, (or a viscoplastic material, ..., or any other similar term), all these terms can be categorized into the “nonlinear” domain. A nonlinear relationship can be seen as a consecutive set of discrete linear events (instants). And for each specific instant, a linear approach based on that specific condition should be more than enough.

The first situation is as shown in Figure C.2d:

$$\sigma_1 = E_1 \varepsilon_1 \quad \sigma_2 = E_2 \varepsilon_2 \quad \sigma_3 = E_a \varepsilon_3 \quad \sigma_4 = E_a \varepsilon_4$$

$$T_1 = \frac{1}{2} \sigma_1 h_1 b = \frac{1}{2} E_1 \varepsilon_1 h_1 b$$

$$C_1 = \frac{1}{2} \sigma_2 h_2 b = \frac{1}{2} E_2 \varepsilon_2 h_2 b$$

$$C_2 = \frac{1}{2} \sigma_3 t b = \frac{1}{2} E_a \varepsilon_3 t b$$

$$C_3 = \frac{1}{2} \sigma_4 t b = \frac{1}{2} E_a \varepsilon_4 t b$$

where

- E_1 = tensile modulus of asphalt concrete,
- E_2 = compressive modulus of asphalt concrete,
- E_a = the elastic modulus of aluminum alloy 6061-T6 (70 GPa),
- σ_i, ε_i = the stress and strain at i th location,
- b = the width of asphalt concrete and aluminum plate,
- h_1, h_2 = the heights of tensile and compressive parts, and
- t = the thickness of the aluminum alloy plate.

To take the moment with point O, the internal moment should be balanced out with the external moment; thus, the following moment equilibrium equation:

$$T_1 \cdot \left(\frac{2}{3} h_1 + h_2 + t \right) + pl = C_1 \cdot \left(\frac{1}{3} h_2 + t \right) + C_2 \cdot \left(\frac{2}{3} t \right) + C_3 \cdot \left(\frac{1}{3} t \right)$$

Because all the measurements of strains can be obtained from the strain gages, it will be easy to calculate the tensile flexural stiffness of asphalt concrete by plugging in and substituting with the corresponding equations mentioned above. It should be noted that Equation 1 is obtained according to the curvature relationship, $\epsilon_1 = -\kappa h_1$, $\epsilon_2 = -\kappa h_2$ and the assumption that Hook's Law holds for tension and compression; therefore, knowing the magnitudes of ϵ_1 and ϵ_2 from strain gage readings, it is easy to find out the relationship of E_1 and E_2 .

The second situation is as shown in Figure C.2e:

If the moment is taken with point O, the following moment equilibrium equation can be used:

$$T_1 \cdot \left(\frac{2}{3} h_1 + h_2 + t \right) + T_2 \cdot \left(\frac{2}{3} t_1 + t_2 \right) + pl = C_1 \cdot \left(\frac{1}{3} h_2 + t \right) + C_2 \cdot \left(\frac{1}{3} t \right)$$

By following the same procedure as in the first situation, the tensile modulus of asphalt concrete can then be easily computed.

C.2. Flexural Frequency Sweep Test

The frequency sweep test is conducted to explore the relationship of loading frequency and the complex modulus of asphalt concrete subjected to various temperatures. The loading frequencies utilized in this study are 15, 10, 5, 2, 1, 0.5, 0.2, 0.1, 0.05, 0.02, and 0.01 Hz. The upper limit of 15 Hz is a constraint imposed by the capabilities of the test machine. The temperatures 40°C, 30°C, and 20°C are herein applied sequentially for the flexural beam test

setup with an aluminum support, or 30°C, 20°C, and 5°C for the test setup without the aluminum support. The general principles to conducting frequency sweep tests are “Quick to Slow in loading frequency and Hot to Cold in temperature.” This is to ensure the specimen is tested in a nondestructive manner. The number of repetitions varies with loading frequency and ranged from 5 periods for 0.01 Hz and 300 periods for 15 Hz. The following presents the corresponding S-PLUS code and an illustrated example. The flexural frequency sweep tests were conducted with both the modified (with support) and conventional (without support) fatigue test setups.

C.2.1 Analysis of Without-Support Setup

```

> fitstn
function(data)
{
  par(mfrow = c(3, 3))
  x <- data$sec
  w <- data$freq[1]
  stn1 <- data$stn1
  stn2 <- data$stn2
  load <- data$load
  lvdt <- data$lvdt
  eq1 <- plotfreq(x, stn1, w, "time(sec)", "stn1", "AC_Top")
  eq2 <- plotfreq(x, stn2, w, "time(sec)", "stn2", "AC_Bottom")
  eq3 <- plotfreq(x, load, w, "time(sec)", "load", "Loadcell_Reading")
  eq4 <- plotfreq(x, lvdt, w, "time(sec)", "lvdt", "LVDT_Reading")
  plotloop(x, eq1, eq2, "stn1", "stn2")
  plotloop(x, eq4, eq1, "lvdt", "stn1")
  plotloop(x, eq4, eq2, "lvdt", "stn2")
  par(mfrow = c(1, 1))
  return(rbind(eq1, eq2, eq3, eq4))
}
> plotfreq
function(x, y, w, xname, yname, title)
{
  A <- abs(max(y) - min(y))/2
  B <- 3
  C <- mean(y)
  plot(x, y, xlab = xname, ylab = yname, main = title)
  lines(x, y)
  tt <- fitsin(x, y, A, B, C, w)
  lines(x, tt[1] * sin(2 * pi * tt[4] * x + tt[2]) + tt[3], col = 2)
  return(tt)
}
> plotloop
function(x, eq1, eq2, name1, name2)
{
  a1 <- eq1[1]
  b1 <- eq1[2]
  c1 <- eq1[3]
  w1 <- eq1[4]
  a2 <- eq2[1]
  b2 <- eq2[2]
  c2 <- eq2[3]
  w2 <- eq2[4]
  eqn1 <- a1 * sin(2 * pi * w1 * x + b1) + c1
  eqn2 <- a2 * sin(2 * pi * w2 * x + b2) + c2

```

```

        plot(eqn1, eqn2, xlab = name1, ylab = name2)
    }
}
>
findmod<-function(stn1,stn2,h,width,load,reaction)
{
    acm<-moment(stn1*1e-6,stn2*1e-6,h,0)*width
    mt1<-acm[1]
    mt2<-acm[2]
    ratio<-abs(stn1)/(abs(stn1)+abs(stn2))
    aa<-(ratio/(1-ratio))^2
    extmoment<-reaction*load*0.001
    eaccomp<-(load*reaction*0.001)/(-mt1+mt2*aa)
    mac1<-mt1*eaccomp
    mac2<-mt2*aa*eaccomp
    eactension<-eaccomp*aa
    k<-1/aa
    return(rbind(eactension,extmoment,mac1,mac2,k))
}

```

C.2.2 Analysis of With-Support Setup

```

> stnsign
function(data)
{
    par(mfrow = c(3, 3))
    x <- data$sec
    w <- data$freq[1]
    stn1 <- data$stn1
    stn2 <- data$stn2
    stn3 <- data$stn3
    stn4 <- data$stn4
    load <- data$load
    eq1 <- plotfreq(x, stn1, w, "time(sec)", "stn1", "AC_Top")
    eq2 <- plotfreq(x, stn2, w, "time(sec)", "stn2", "AC_Bottom")
    eq3 <- plotfreq(x, stn3, w, "time(sec)", "stn3", "AL_Top")
    eq4 <- plotfreq(x, stn4, w, "time(sec)", "stn4", "AL_Bottom")
    eq5 <- plotfreq(x, load, w, "time(sec)", "load", "Loadcell_Reading")
    plotloop(x, eq1, eq2, "stn1", "stn2")
    plotloop(x, eq2, eq3, "stn2", "stn3")
    plotloop(x, eq3, eq4, "stn3", "stn4")
    plotloop(x, eq1, eq3, "stn1", "stn3")
    par(mfrow = c(1, 1))
    return(rbind(eq1, eq2, eq3, eq4, eq5))
}
>
> plotloop
function(x, eq1, eq2, name1, name2)
{
    a1 <- eq1[1]
    b1 <- eq1[2]
    c1 <- eq1[3]
    w1 <- eq1[4]
    a2 <- eq2[1]
    b2 <- eq2[2]
    c2 <- eq2[3]
    w2 <- eq2[4]
    eqn1 <- a1 * sin(2 * pi * w1 * x + b1) + c1
    eqn2 <- a2 * sin(2 * pi * w2 * x + b2) + c2
    plot(eqn1, eqn2, xlab = name1, ylab = name2)
}
> plotfreq
function(x, y, w, xname, yname, title)
{
    A <- abs(max(y) - min(y))/2
    B <- 3
    C <- mean(y)
    plot(x, y, xlab = xname, ylab = yname, main = title)
    lines(x, y)
}

```

```

tt <- fitsin(x, y, A, B, C, w)
lines(x, tt[1] * sin(2 * pi * tt[4] * x + tt[2]) + tt[3], col = 2)
return(tt)
}
>

moment<-function(stn1, stn2, h, offset)
{
  if(stn1 * stn2 > 0) {
    m1 <- 0.5 * stn1 * h * (2/3 * h + offset)
    m2 <- 0.5 * stn2 * h * (1/3 * h + offset)
  }
  else {
    h1 <- abs(stn1)/(abs(stn1) + abs(stn2)) * h
    h2 <- h - h1
    m1 <- 0.5 * stn1 * h1 * (h2 + offset + 2/3 * h1)
    m2 <- 0.5 * stn2 * h2 * (1/3 * h2 + offset)
  }
  return(c(m1, m2))
}

acmodulus<-function(stn1,stn2,stn3,stn4,h,offset,width,load,reaction,eal)
{
  acm<-moment(stn1*1e-6,stn2*1e-6,h,offset)*width
  alm<-moment(stn3*1e-6,stn4*1e-6,offset,0)*width*eal
  mt1<-acm[1]
  mt2<-acm[2]
  mt3<-alm[1]
  mt4<-alm[2]
  ratio<-abs(stn1)/(abs(stn1)+abs(stn2))
  aa<-(ratio/(1-ratio))^2
  eactension<-(load*reaction*0.001-(mt3+mt4))/(mt1+aa*mt2)
  extmoment<-reaction*load*0.001
  mac1<-mt1*eactension
  mac2<-mt2*eactension*aa
  mal3<-mt3
  mal4<-mt4
  return(rbind(eactension,extmoment,mac1,mac2,mal3,mal4,aa))
}

```

C.3 High Temperature Fatigue Test

The theoretical derivation of the high temperature flexural controlled-strain fatigue test is based on the flexural beam analysis with support mentioned in Section C.1.2. The main purpose of this analysis is to calculate the tensile complex modulus of asphalt concrete and thus monitor its stiffness deterioration process at high temperatures. Several constraints were imposed on this analysis. First, the function only accepts special formatted input as illustrated in the following S-PLUS code. Second, it assumes 50 points are collected for each period but the nonlinear fitting will takes two consecutive periods, i.e., 100 points, into account. Third, the function is

conducted period by period because the initial value for the nonlinear fitting is not the same for every period.

S-PLUS code for the high temperature fatigue analysis

```
# This fatigue program is specific for the analysis of high temperature fatigue test with #
support and with strain gages attached on top and bottom of asphalt concrete beam and #
aluminum support.
# The input data frame format is as follows:
```

sec	cycle	load	lvdt	stn1	stn2	stn3	stn4
0.901	9	230.729	-0.23914	-311.416	355.079	-40.8503	45.6121
0.903	9	132.795	-0.22253	-283.394	329.322	-43.3322	41.888

```
# (Note: the heading of this input file should be exactly the same as above.)
# The parameters are described in following:
#   data: the input data frame,
#   B: the input phase angle to conduct the nonlinear fitting,
#   filename: the destination file name to store the output result,
#   the output file format is as follow,
#   period, stiffness (GPa), tensile strain in AC_Top, load (N), lvdt (mm), and coefficient K
# (where, Ec=Ket).
#   H: height of asphalt concrete beam,
#   Offset: thickness of aluminum support,
#   Width: the width of asphalt concrete beam,
#   Reaction: machine specified length which is roughly one third of asphalt concrete
#   Length, and
#   Eal: the elastic modulus of aluminum support (70 GPa)
# The output will be stored in a specified filename of a specified directory.
# The following shows the output format:
#
```

period	Stif.	load	lvdt	K	stn1	stn2	stn3	stn4
10	3.928	395.1356	0.122828	1.252199	412.0693	-368.242	16.4413	-34.3998
25	3.932	285.4153	0.087983	1.297376	297.888	-261.529	-12.6144	-25.4100

```
> fatigue
function(data, B, filename, h, offset, width, reaction, eal)
{
  par(mfrow = c(4, 3))
  period <- data$cycle[length(data$cycle)]
  x <- data$sec
  x <- x - x[1]
  w <- 10
  stn1 <- data$stn1
  stn2 <- data$stn2
  stn3 <- data$stn3
  stn4 <- data$stn4
  load <- data$load
  lvdt <- data$lvdt
  eq1 <- xplotfreq(x, stn1, w, "time(sec)", "stn1", "AC_Top", B)
  eq2 <- xplotfreq(x, stn2, w, "time(sec)", "stn2", "AC_Bottom", B)
  eq3 <- xplotfreq(x, stn3, w, "time(sec)", "stn3", "AL_Top", B)
  eq4 <- xplotfreq(x, stn4, w, "time(sec)", "stn4", "AL_Bottom", B)
  eq5 <- xplotfreq(x, load, w, "time(sec)", "load", "Loadcell_Reading", B)
  eq6 <- xplotfreq(x, lvdt, w, "time(sec)", "lvdt", "Lvdt_Reading", B)
  s1 <- plotloop(x[1:50], eq1, eq6, "stn1", "lvdt")
  s2 <- plotloop(x[1:50], eq2, eq6, "stn2", "lvdt")
  s3 <- plotloop(x[1:50], eq3, eq6, "stn3", "lvdt")
  s4 <- plotloop(x[1:50], eq4, eq6, "stn4", "lvdt")
  if(s1 > 0)
    sign1 <- 1
  else sign1 <- -1
  if(s2 > 0)
```

```

        sign2 <- 1
    else sign2 <- -1
    if(s3 > 0)
        sign3 <- 1
    else sign3 <- -1
    if(s4 > 0)
        sign4 <- 1
    else sign4 <- -1
    par(mfrow = c(1, 1))
    sign <- c(sign1, sign2, sign3, sign4)
    cat("period = ", period, "\n")
    strain1 <- eq1
    strain2 <- eq2
    strain3 <- eq3
    strain4 <- eq4
    loadcell <- eq5
    lvdreading <- eq6
    am <- sign * c(abs(eq1[1]), abs(eq2[1]), abs(eq3[1]), abs(eq4[1])) * 2
    modulus <- acmodulus(am[1], am[2], am[3], am[4], h, offset, width, abs(eq5[1]), reaction,
eal)
    acmod <- modulus[1]
    write(c(period, acmod, abs(eq5[1]), abs(eq6[1]), modulus[7], am[1], am[2], am[3], am[4]),
ncol
        = 9, file = filename, append = T)
    return(rbind(strain1, strain2, strain3, strain4, loadcell, lvdreading, sign), modulus)
}
>
# =====
# This splus function "fatigue1" is utilized while the values of lvd are out of
# range. Therefore, it does not conduct the nonlinear fit for the lvd curves
# and will use the AC_Top tensile strain as a standard to identify the signs for
# the other three strain gages. The sign AC_Top strain gage is positive due to
# the bending up test setup.

> fatigue1
function(data, B, filename, h, offset, width, reaction, eal)
{
    par(mfrow = c(4, 3))
    period <- data$cycle[length(data$cycle)]
    x <- data$sec
    x <- x - x[1]
    w <- 10
    stn1 <- data$stn1
    stn2 <- data$stn2
    stn3 <- data$stn3
    stn4 <- data$stn4
    load <- data$load
    lvd <- data$lvd
    eq1 <- xplotfreq(x, stn1, w, "time(sec)", "stn1", "AC_Top", B)
    eq2 <- xplotfreq(x, stn2, w, "time(sec)", "stn2", "AC_Bottom", B)
    eq3 <- xplotfreq(x, stn3, w, "time(sec)", "stn3", "AL_Top", B)
    eq4 <- xplotfreq(x, stn4, w, "time(sec)", "stn4", "AL_Bottom", B)
    eq5 <- xplotfreq(x, load, w, "time(sec)", "load", "Loadcell_Reading", B)
    s1 <- plotloop(x[1:50], eq1, eq1, "stn1", "stn1")
    s2 <- plotloop(x[1:50], eq2, eq1, "stn2", "stn1")
    s3 <- plotloop(x[1:50], eq3, eq1, "stn3", "stn1")
    s4 <- plotloop(x[1:50], eq4, eq1, "stn4", "stn1")
    if(s1 > 0)
        sign1 <- 1
    else sign1 <- -1
    if(s2 > 0)
        sign2 <- 1
    else sign2 <- -1
    if(s3 > 0)
        sign3 <- 1
    else sign3 <- -1
    if(s4 > 0)
        sign4 <- 1
    else sign4 <- -1
    par(mfrow = c(1, 1))
    sign <- c(sign1, sign2, sign3, sign4)
}

```



```

cat("period = ", period, "\n")
strain1 <- eq1
strain2 <- eq2
strain3 <- eq3
strain4 <- eq4
loadcell <- eq5
am <- sign * c(abs(eq1[1]), abs(eq2[1]), abs(eq3[1]), abs(eq4[1])) * 2
modulus <- acmodulus(am[1], am[2], am[3], am[4], h, offset, width, abs(eq5[1]), reaction,
eal)
acmod <- modulus[1]
write(c(period, acmod, abs(eq5[1]), "NA", modulus[7], am[1], am[2], am[3], am[4]), ncol =
9,
      file = filename, append = T)
return(rbind(strain1, strain2, strain3, strain4, loadcell, sign), modulus)
}
> >

# =====

> acmodulus
function(stn1, stn2, stn3, stn4, h, offset, width, load, reaction, eal)
{
  acm <- moment(stn1 * 1e-006, stn2 * 1e-006, h, offset) * width
  alm <- moment(stn3 * 1e-006, stn4 * 1e-006, offset, 0) * width * eal
  mt1 <- acm[1]
  mt2 <- acm[2]
  mt3 <- alm[1]
  mt4 <- alm[2]
  ratio <- abs(stn1)/(abs(stn1) + abs(stn2))
  aa <- (ratio/(1 - ratio))^2
  eactension <- (load * reaction * 0.001 - (mt3 + mt4))/(mt1 + aa * mt2)
  extmoment <- reaction * load * 0.001
  mac1 <- mt1 * eactension
  mac2 <- mt2 * eactension * aa
  mal3 <- mt3
  mal4 <- mt4
  return(rbind(eactension, extmoment, mac1, mac2, mal3, mal4, aa))
}
>

> xplotfreq
function(x, y, w, xname, yname, title, B)
{
  A <- abs(max(y) - min(y))/2
  C <- mean(y)
  plot(x, y, xlab = xname, ylab = yname, main = title)
  lines(x, y)
  tt <- fitsin(x, y, A, B, C, w)
  lines(x, tt[1] * sin(2 * pi * tt[4] * x + tt[2]) + tt[3], col = 2)
  return(tt)
}

> plotloop
function(x, eq1, eq2, name1, name2)
{
  a1 <- eq1[1]
  b1 <- eq1[2]
  c1 <- eq1[3]
  w1 <- eq1[4]
  a2 <- eq2[1]
  b2 <- eq2[2]
  c2 <- eq2[3]
  w2 <- eq2[4]
  eqn1 <- a1 * sin(2 * pi * w1 * x + b1) + c1
  eqn2 <- a2 * sin(2 * pi * w2 * x + b2) + c2
  plot(eqn1, eqn2, xlab = name1, ylab = name2)
  sign <- tellsign(eqn1, eqn2)
  sign
}
> tellsign

```

```

function(x, y)
{
  xy <- cbind(x, y)
  xmin <- xy[xy[, 1] == min(xy[, 1]), ]
  if(length(xmin) == 4)
    xmin <- xmin[2, ]
  xmax <- xy[xy[, 1] == max(xy[, 1]), ]
  if(length(xmax)[1] == 4)
    xmax <- xmax[2, ]
  ratio <- (xmax[2] - xmin[2])/(xmax[1] - xmin[1])
  if(ratio > 0)
    result <- 1
  else result <- -1
  result
}
>

```

C.4 Varied-Strain Fatigue Test

The purpose of writing the S-PLUS code for this type of test is to make possible the analyses of sequential fatigue tests with various strain levels, which cannot be analyzed by the Automated Testing System (ATS) software. Two functions, `fat()` and `fat1()` were written for the 400-200-400 microstrain type of test and the 200-400 microstrain type of test, respectively.

The corresponding S-PLUS code is listed below.

```

> fat
function(data, h, w, l)
{
  onefat <- function(data, h, w, l, addterm)
  {
    stressfactor <- function(h, w, l)
    {
      a <- l/3
      x <- (3 * a)/(w * h * h)
      x
    }
    strainfactor <- function(h, l)
    {
      a <- l/3
      y <- (12 * h)/(3 * l * l - 4 * a * a)
      y
    }
    area <- function(x, y)
    {
      len <- length(x)
      x <- c(x, x[1])
      y <- c(y, y[1])
      sum <- 0
      for(i in 1:len) {
        sum <- sum + (x[i] * y[i + 1] - y[i] * x[i + 1])
      }
      result <- abs(sum)/2
      result
    }
    stsfac <- stressfactor(h, w, l)
    stnfac <- strainfactor(h, l)
    data.sp <- split(data, data$cycle)
  }
}

```

```

count <- length(data$temp)/50
result <- matrix(nrow = count, ncol = 6)
for(i in 1:count) {
  sts <- (max(data.sp[[i]]$load) - min(data.sp[[i]]$load)) * stsfac
  stn <- (max(data.sp[[i]]$lvd) - min(data.sp[[i]]$lvd)) * stnfac
  loopx <- as.vector(data.sp[[i]]$load)
  loopy <- as.vector(data.sp[[i]]$lvd)
  de <- area(loopx, loopy) * stsfac * stnfac
  k <- sts/stn
  result[i, 1] <- data.sp[[i]]$cycle[1] + addterm
  result[i, 2] <- mean(data.sp[[i]]$temp)
  result[i, 3] <- sts
  result[i, 4] <- stn
  result[i, 5] <- k
  result[i, 6] <- de
}
xxx <- as.data.frame(result)
xxx
}
xxx.sp <- split(data, data$seq)
data1 <- xxx.sp[[1]]
data1.len <- length(data1$load)
term1 <- data1$cycle[data1.len]
data2 <- xxx.sp[[2]]
data2.len <- length(data2$load)
term2 <- data2$cycle[data2.len]
data3 <- xxx.sp[[3]]
data1.res <- onefat(data1, h, w, 1, 0)
data2.res <- onefat(data2, h, w, 1, term1)
data3.res <- onefat(data3, h, w, 1, term1 + term2)
final <- rbind(data1.res, data2.res, data3.res) # calculate cumulative dissipated
energy
final.len <- length(final[, 1])
cde <- matrix(nrow = final.len, ncol = 1)
cde[1] <- final[1, 1] * final[1, 6]
for(i in 2:final.len) {
  cde[i] <- cde[i - 1] + ((final[i, 1] - final[i - 1, 1]) * (final[i, 6] + final[i -
1, 6]
    ))/2
}
final.res <- as.data.frame(cbind(final, cde))
names(final.res) <- c("period", "mtmp", "sts", "stn", "mod", "de", "cde")
final.res
}

fat1<-function(data, h, w, l)
{
  onefat <- function(data, h, w, l, addterm)
  {
    stressfactor <- function(h, w, l)
    {
      a <- l/3
      x <- (3 * a)/(w * h * h)
      x
    }
    strainfactor <- function(h, l)
    {
      a <- l/3
      y <- (12 * h)/(3 * l * l - 4 * a * a)
      y
    }
    area <- function(x, y)
    {
      len <- length(x)
      x <- c(x, x[1])
      y <- c(y, y[1])
      sum <- 0
      for(i in 1:len) {
        sum <- sum + (x[i] * y[i + 1] - y[i] * x[i + 1])
      }
      result <- abs(sum)/2
    }
  }
}

```

```

        result
    }
    stsfac <- stressfactor(h, w, l)
    stnfac <- strainfactor(h, l)
    data.sp <- split(data, data$cycle)
    count <- length(data$temp)/50
    result <- matrix(nrow = count, ncol = 6)
    for(i in 1:count) {
        sts <- (max(data.sp[[i]]$load) - min(data.sp[[i]]$load)) * stsfac
        stn <- (max(data.sp[[i]]$lvd) - min(data.sp[[i]]$lvd)) * stnfac
        loopx <- as.vector(data.sp[[i]]$load)
        loopy <- as.vector(data.sp[[i]]$lvd)
        de <- area(loopx, loopy) * stsfac * stnfac
        k <- sts/stn
        result[i, 1] <- data.sp[[i]]$cycle[1] + addterm
        result[i, 2] <- mean(data.sp[[i]]$temp)
        result[i, 3] <- sts
        result[i, 4] <- stn
        result[i, 5] <- k
        result[i, 6] <- de
    }
    xxx <- as.data.frame(result)
    xxx
}
xxx.sp <- split(data, data$seq)
data1 <- xxx.sp[[1]]
data1.len <- length(data1$load)
term1 <- data1$cycle[data1.len]
data2 <- xxx.sp[[2]]
data2.len <- length(data2$load)
term2 <- data2$cycle[data2.len]
data3 <- xxx.sp[[3]]
data1.res <- onefat(data1, h, w, l, 0)
data2.res <- onefat(data2, h, w, l, term1)

final <- rbind(data1.res, data2.res) # calculate cumulative dissipated energy
final.len <- length(final[, 1])
cde <- matrix(nrow = final.len, ncol = 1)
cde[1] <- final[1, 1] * final[1, 6]
for(i in 2:final.len) {
    cde[i] <- cde[i - 1] + ((final[i, 1] - final[i - 1, 1]) * (final[i, 6] + final[i -
1, 6]
        ))/2
}
final.res <- as.data.frame(cbind(final, cde))
names(final.res) <- c("period", "mtmp", "sts", "stn", "mod", "de", "cde")
final.res
}

```

C.5 Simulation of Correlated Random Variables

The main purpose of this simulation is to present a visual relationship of the correlation coefficient and the random variables. To do this one needs to generate two correlated random variables with a normal distribution $N(0,1)$, which has $\mu = 0$, and $\sigma = 1$. The theoretical procedure for generating the correlated random variables is briefly described here (Spector 1996):

If $E(X) = \Theta$ and $Var(X) = \Omega$,

Then $E(u'X) = u'\Theta$ and $Var(u'X) = u'\Omega u$.

Suppose random variables with $E(X) = \Theta$ and $Var(X) = I$ are simulated (i.e., no correlation).

Then $E(u'X) = u'\Theta$ and $Var(u'X) = u'u$

Suppose the random variables with $Var(Y) = \Omega$ are desired

Then use the Cholesky decomposition on $\Omega \Rightarrow u'u$

Therefore, $Y = u'X$ has $E(u'X) = u'\Theta$ and $Var(u'X) = u'u = \Omega$.

It should be noted that the above-illustrated symbols are in matrix form and u represents an upper triangular matrix. The correlation (ρ) of two jointly distributed random variables X and Y is defined as

$$\rho = \frac{Cov(X, Y)}{\sqrt{Var(X)} \cdot \sqrt{Var(Y)}}$$

Note that X and Y are two random variables with a normal distribution $N(0,1)$, i.e.,

$Var(X) = Var(Y) = 1$; therefore, in such a case, $\rho = Cov(X, Y)$.

```
> bivar
function(lo, n = 500)
#
# this function is to generate a set of bivariate normal distribution random variables
# with a specified correlation coefficient and demonstrate the linear relationship
# between two random variables.
#
# lo: the correlation coefficient
# the default sampling size is 500.
#
# The function will return two sets of random variables with the specified correlation
```

```
# coefficient.  
#  
{  
  vmat <- matrix(c(1, lo, lo, 1), nc = 2, byrow = T)  
  uu <- chol(vmat)  
  xx <- rnorm(n, 0, 1)  
  yy <- rnorm(n, 0, 1)  
  temp <- t(uu) %*% as.matrix(rbind(xx, yy))  
  x <- temp[1, ]  
  y <- temp[2, ]  
  return(x, y)  
}  
>
```

APPENDIX D: S-PLUS CODE FOR CHAPTER 6

D.1 S-PLUS CODE FOR STRATIFICATION

The purpose of the `cellsum()` function is to categorize the field data of the (T_b, g, sg) data sets into appropriate cubic cells which are constructed by subdividing the three coordinate axes, i.e., (T_b, g, sg) , into several subranges each with a constant interval. In the following, the `cellsum(x, ra, rb, rc, da, db, dc)` has 7 parameters: x is the data set containing three columns (T_b, g, sg) ; ra is a vector containing points with a constant interval of da for the temperature at the bottom of the asphalt concrete, rb with a constant interval of db is for the temperature gradient, and rc with a constant interval of dc is for the modulus of the subgrade. Notice that the sets of points include the beginning and ending points. Another function used here is the function `findcell(x, aa, bb, cc, dd, ee, ff)`, which serves as a subroutine of function `cellsum()`. The `findcell()` function returns a set of (x, y, z) data that is $aa \leq x \leq bb$, $cc \leq y \leq dd$, and $ee \leq z \leq ff$. The outcome of this function is a statistical summary of all the cubic cells, mainly including the number of points, means, and standard deviations for each cubic cell. Then, the Circl program was executed according to the summary table. The S-PLUS code of functions `cellsum()` and `findcell()` is listed in the following paragraphs.

D.1.1 Cellsum() Function

```
>cellsum<-function(x,ra,rb,rc,da,db,dc)
{
  result<-0
  for(i in ra){
    for(j in rb){
      for(k in rc){
        cell<-findcell(x,i,i+da,j,j+db,k,k+dc)
        if(is.na(cell[1,1])){
          count<-0
          sdx<-NA
          sdy<-NA
          sdz<-NA
          mx<-NA
          my<-NA
          mz<-NA
        }
        else{
          if(length(cell[, 1])==1){
            count<-1
            sdx<-NA
            sdy<-NA
            sdz<-NA
            mx<-cell[1,1]
            my<-cell[1,2]
            mz<-cell[1,3]
          }
          else{
            count<-length(cell[,1])
            sdx<-sqrt(var(cell[,1]))
            sdy<-sqrt(var(cell[,2]))
            sdz<-sqrt(var(cell[,3]))
            mx<-mean(cell[,1])
            my<-mean(cell[,2])
            mz<-mean(cell[,3])
          }
        }
        result<-rbind(result,c(i,i+da,j,j+db,k,k+dc,count,mx,my,mz,sdx,sdy,sdz))
      }
    }
  }
  result<-as.matrix(result)
  dimnames(result)<- list(NULL,c("Xa","Xb","Ya","Yb","Za","Zb","Freq.,""Xmean","Ymean"
    ,"Zmean","SDX","SDY","SDZ"))
  result[-1,]
}
```

D.1.2 Findcell() Function

```
> findcell<-function(x,aa,bb,cc,dd,ee,ff)
{
  xr<-x[x[,1]<=bb,]
  xr1<-xr[xr[,1]>aa,]
  if(length(xr1)==0){
    xr1<-t(as.matrix(c(NA,NA,NA)))
    xr1
  }
  else{
    if(length(xr1)==3)
      xr1<-t(as.matrix(xr1))
      yr<-xr1[xr1[,2]<=dd,]
      if(length(yr)==0){
        yr<-t(as.matrix(c(NA,NA,NA)))
        yr
      }
      else{
        if(length(yr)==3)
          yr<-t(as.matrix(yr))
          yr1<-yr[yr[,2]>cc,]
          if(length(yr1)==0){
            yr1<-t(as.matrix(c(NA,NA,NA)))
            yr1
          }
          else{
            if(length(yr1)==3)
              yr1<-t(as.matrix(yr1))
              zr<-yr1[yr1[,3]<=ff,]
              if(length(zr) == 0){
                zr<-t(as.matrix(c(NA,NA,NA)))
                zr
              }
              else{
                if(length(zr)==3)
                  zr<-t(as.matrix(zr))
                  zr1<-zr[zr[,3]>ee, ]
                  if(length(zr1)==0){
                    zr1<-t(as.matrix(c(NA,NA,NA)))
                    zr1
                  }
                  else{
                    if(length(zr1)==3){
                      zr1<-t(as.matrix(zr1))
                      zr1
                    }
                    else
                      zr1
                  }
              }
            }
          }
        }
      }
    }
  }
}
```

D.1.3 Stratification Output of the WesTrack Field Data

```

> cellsum(sgx,ra,rb,rc,10,0.05,5)
  Xa Xb  Ya  Yb  Za  Zb Freq.  Xmean  Ymean  Zmean  SDX  SDY  SDZ
[1,] -10 0 -0.15 -0.10 90 95 0 NA NA NA NA NA NA
[2,] -10 0 -0.15 -0.10 95 100 0 NA NA NA NA NA NA
[3,] -10 0 -0.15 -0.10 100 105 0 NA NA NA NA NA NA
[4,] -10 0 -0.15 -0.10 105 110 0 NA NA NA NA NA NA
[5,] -10 0 -0.15 -0.10 110 115 0 NA NA NA NA NA NA
[6,] -10 0 -0.15 -0.10 115 120 0 NA NA NA NA NA NA
[7,] -10 0 -0.10 -0.05 90 95 0 NA NA NA NA NA NA
[8,] -10 0 -0.10 -0.05 95 100 0 NA NA NA NA NA NA
[9,] -10 0 -0.10 -0.05 100 105 0 NA NA NA NA NA NA
[10,] -10 0 -0.10 -0.05 105 110 0 NA NA NA NA NA NA
[11,] -10 0 -0.10 -0.05 110 115 8 -2.2410271 -0.05180993 113.2968 0.6026753 0.001415437 0.4614003
[12,] -10 0 -0.10 -0.05 115 120 0 NA NA NA NA NA NA
[13,] -10 0 -0.05 0.00 90 95 0 NA NA NA NA NA NA
[14,] -10 0 -0.05 0.00 95 100 0 NA NA NA NA NA NA
[15,] -10 0 -0.05 0.00 100 105 6 -0.2737441 -0.02424490 103.0357 0.2014335 0.017664603 1.2495332
[16,] -10 0 -0.05 0.00 105 110 0 NA NA NA NA NA NA
[17,] -10 0 -0.05 0.00 110 115 297 -1.4980137 -0.02907022 112.9500 1.3881236 0.011982940 0.9926875
[18,] -10 0 -0.05 0.00 115 120 0 NA NA NA NA NA NA
[19,] -10 0 0.00 0.05 90 95 0 NA NA NA NA NA NA
[20,] -10 0 0.00 0.05 95 100 0 NA NA NA NA NA NA
[21,] -10 0 0.00 0.05 100 105 0 NA NA NA NA NA NA
[22,] -10 0 0.00 0.05 105 110 0 NA NA NA NA NA NA
[23,] -10 0 0.00 0.05 110 115 56 -1.1173477 0.02400832 113.0472 0.8588701 0.013579456 0.9173919
[24,] -10 0 0.00 0.05 115 120 0 NA NA NA NA NA NA
[25,] -10 0 0.05 0.10 90 95 0 NA NA NA NA NA NA
[26,] -10 0 0.05 0.10 95 100 0 NA NA NA NA NA NA
[27,] -10 0 0.05 0.10 100 105 0 NA NA NA NA NA NA
[28,] -10 0 0.05 0.10 105 110 0 NA NA NA NA NA NA
  Xa Xb  Ya  Yb  Za  Zb Freq.  Xmean  Ymean  Zmean  SDX  SDY  SDZ
[29,] -10 0 0.05 0.10 110 115 4 -0.4702953 0.05702640 113.58904 0.3332527 0.001629490 0.1166629
[30,] -10 0 0.05 0.10 115 120 0 NA NA NA NA NA NA
[31,] -10 0 0.10 0.15 90 95 0 NA NA NA NA NA NA
[32,] -10 0 0.10 0.15 95 100 0 NA NA NA NA NA NA
[33,] -10 0 0.10 0.15 100 105 0 NA NA NA NA NA NA
[34,] -10 0 0.10 0.15 105 110 0 NA NA NA NA NA NA
[35,] -10 0 0.10 0.15 110 115 0 NA NA NA NA NA NA
[36,] -10 0 0.10 0.15 115 120 0 NA NA NA NA NA NA
[37,] 0 10 -0.15 -0.10 90 95 0 NA NA NA NA NA NA
[38,] 0 10 -0.15 -0.10 95 100 0 NA NA NA NA NA NA
[39,] 0 10 -0.15 -0.10 100 105 0 NA NA NA NA NA NA
[40,] 0 10 -0.15 -0.10 105 110 0 NA NA NA NA NA NA
[41,] 0 10 -0.15 -0.10 110 115 0 NA NA NA NA NA NA
[42,] 0 10 -0.15 -0.10 115 120 0 NA NA NA NA NA NA
[43,] 0 10 -0.10 -0.05 90 95 6 9.0989265 -0.05128116 94.25935 1.0987051 0.001261055 0.4423735
[44,] 0 10 -0.10 -0.05 95 100 29 7.7085982 -0.05445682 97.68937 1.8014292 0.003356731 1.3958453
[45,] 0 10 -0.10 -0.05 100 105 17 7.7513343 -0.05423932 101.68003 1.4506262 0.002249209 0.9306973
[46,] 0 10 -0.10 -0.05 105 110 5 5.5625108 -0.05293808 108.92724 2.4106945 0.002164880 0.2636632
[47,] 0 10 -0.10 -0.05 110 115 84 6.9113525 -0.05538080 111.98424 2.3615388 0.005422832 1.3688303
[48,] 0 10 -0.10 -0.05 115 120 0 NA NA NA NA NA NA
[49,] 0 10 -0.05 0.00 90 95 45 8.6423185 -0.03123070 94.16985 1.0474636 0.014229406 1.1306639
[50,] 0 10 -0.05 0.00 95 100 255 8.0963015 -0.03318805 97.08773 1.4804672 0.012296884 1.1735135
[51,] 0 10 -0.05 0.00 100 105 575 6.4207001 -0.02962962 102.85697 2.2575033 0.011418427 1.3563647
[52,] 0 10 -0.05 0.00 105 110 767 5.4539392 -0.02315735 107.67029 2.1456164 0.011967447 1.3781369
[53,] 0 10 -0.05 0.00 110 115 2171 5.0916055 -0.02427589 113.00685 2.7437372 0.012581726 1.2275130
[54,] 0 10 -0.05 0.00 115 120 0 NA NA NA NA NA NA
[55,] 0 10 0.00 0.05 90 95 14 8.7388199 0.02285638 94.49417 1.2292061 0.011507526 0.4615980
[56,] 0 10 0.00 0.05 95 100 88 8.1992314 0.02305022 97.45234 1.4459569 0.013554241 1.3374000
  Xa Xb  Ya  Yb  Za  Zb Freq.  Xmean  Ymean  Zmean  SDX  SDY  SDZ
[57,] 0 10 0.00 0.05 100 105 142 6.188311 0.02402441 102.71627 2.2981629 0.014780815 1.5042065
[58,] 0 10 0.00 0.05 105 110 233 5.542536 0.02376650 107.82579 2.4885471 0.015162818 1.3244478
[59,] 0 10 0.00 0.05 110 115 729 5.619965 0.02219189 112.89607 2.5174420 0.014600739 1.2866422
[60,] 0 10 0.00 0.05 115 120 0 NA NA NA NA NA NA
[61,] 0 10 0.05 0.10 90 95 7 8.476257 0.06395796 94.56178 0.8180133 0.013669098 0.1707945
[62,] 0 10 0.05 0.10 95 100 39 8.295478 0.07076737 97.00438 1.5636944 0.013902249 1.2230067
[63,] 0 10 0.05 0.10 100 105 117 7.171362 0.07110835 102.83038 2.0475125 0.012744344 1.3376730
[64,] 0 10 0.05 0.10 105 110 139 6.748009 0.06982928 107.66804 1.8923044 0.013583963 1.4762495
[65,] 0 10 0.05 0.10 110 115 215 5.411796 0.06224480 112.98836 2.7969038 0.010114182 1.2470978
[66,] 0 10 0.05 0.10 115 120 0 NA NA NA NA NA NA
[67,] 0 10 0.10 0.15 90 95 0 NA NA NA NA NA NA
[68,] 0 10 0.10 0.15 95 100 1 9.527126 0.10238839 97.89440 NA NA NA NA NA NA
[69,] 0 10 0.10 0.15 100 105 13 8.245000 0.10635409 101.89829 1.2436494 0.006288321 1.0390522
[70,] 0 10 0.10 0.15 105 110 3 7.956227 0.10357257 106.07375 1.3608811 0.004441195 0.7010265
[71,] 0 10 0.10 0.15 110 115 0 NA NA NA NA NA NA
[72,] 0 10 0.10 0.15 115 120 0 NA NA NA NA NA NA
[73,] 10 20 -0.15 -0.10 90 95 0 NA NA NA NA NA NA
[74,] 10 20 -0.15 -0.10 95 100 0 NA NA NA NA NA NA
[75,] 10 20 -0.15 -0.10 100 105 0 NA NA NA NA NA NA
[76,] 10 20 -0.15 -0.10 105 110 0 NA NA NA NA NA NA
[77,] 10 20 -0.15 -0.10 110 115 0 NA NA NA NA NA NA
[78,] 10 20 -0.15 -0.10 115 120 0 NA NA NA NA NA NA
[79,] 10 20 -0.10 -0.05 90 95 225 16.327505 -0.05496448 92.14206 2.7116451 0.003610631 1.4113894
[80,] 10 20 -0.10 -0.05 95 100 55 12.657208 -0.05441023 97.28873 1.7048839 0.003435295 1.4697730
[81,] 10 20 -0.10 -0.05 100 105 46 18.027342 -0.05731546 103.59665 2.5754113 0.004161720 1.1167985
[82,] 10 20 -0.10 -0.05 105 110 140 15.760316 -0.05598991 108.54189 2.6295414 0.004513991 1.1870281
[83,] 10 20 -0.10 -0.05 110 115 66 12.357750 -0.05646340 110.64559 1.5649501 0.004662694 0.6557323
[84,] 10 20 -0.10 -0.05 115 120 0 NA NA NA NA NA NA
  Xa Xb  Ya  Yb  Za  Zb Freq.  Xmean  Ymean  Zmean  SDX  SDY  SDZ
[85,] 10 20 -0.05 0.00 90 95 909 16.54025 -0.03373725 92.28621 2.331124 0.012053880 1.5243185

```

[86,]	10	20	-0.05	0.00	95	100	775	14.11615	-0.03116140	97.40712	2.691952	0.011711545	1.4840416
[87,]	10	20	-0.05	0.00	100	105	337	13.60545	-0.02509906	101.53688	2.467370	0.011478133	1.3161559
[88,]	10	20	-0.05	0.00	105	110	355	16.32490	-0.03256209	107.46088	2.774086	0.013788184	1.5636241
[89,]	10	20	-0.05	0.00	110	115	569	12.89454	-0.02479433	112.20494	2.379942	0.013864005	1.1633702
[90,]	10	20	-0.05	0.00	115	120	0	NA	NA	NA	NA	NA	NA
[91,]	10	20	0.00	0.05	90	95	294	16.19955	0.02439048	92.03383	2.630707	0.015588535	1.5298853
[92,]	10	20	0.00	0.05	95	100	215	14.62868	0.02445470	97.42914	3.029637	0.014827393	1.3694278
[93,]	10	20	0.00	0.05	100	105	143	15.27553	0.02404933	102.13440	3.035883	0.015078154	1.5695998
[94,]	10	20	0.00	0.05	105	110	151	15.11861	0.02493240	107.58173	3.130391	0.014615833	1.4614546
[95,]	10	20	0.00	0.05	110	115	244	13.12115	0.02377968	112.53213	2.417385	0.014604177	1.1474209
[96,]	10	20	0.00	0.05	115	120	0	NA	NA	NA	NA	NA	NA
[97,]	10	20	0.05	0.10	90	95	245	16.79426	0.07408769	92.64196	2.462599	0.014123438	1.5050050
[98,]	10	20	0.05	0.10	95	100	268	15.03019	0.07583973	97.31663	2.778626	0.014110535	1.4744333
[99,]	10	20	0.05	0.10	100	105	132	14.38715	0.07475339	101.97114	2.950486	0.014578095	1.4175251
[100,]	10	20	0.05	0.10	105	110	98	16.09176	0.07025354	107.75773	3.122327	0.013253416	1.5899045
[101,]	10	20	0.05	0.10	110	115	172	13.56186	0.06884719	111.88119	2.560288	0.012458059	1.2175153
[102,]	10	20	0.05	0.10	115	120	0	NA	NA	NA	NA	NA	NA
[103,]	10	20	0.10	0.15	90	95	80	17.62329	0.11412917	92.99694	2.001630	0.010191947	1.4358705
[104,]	10	20	0.10	0.15	95	100	74	15.66211	0.10859041	97.30768	2.380847	0.006688470	1.7240776
[105,]	10	20	0.10	0.15	100	105	54	13.74402	0.11101695	101.24078	2.314327	0.007920002	0.7911365
[106,]	10	20	0.10	0.15	105	110	5	17.83314	0.10230429	109.06350	1.327255	0.002299840	0.2361347
[107,]	10	20	0.10	0.15	110	115	0	NA	NA	NA	NA	NA	NA
[108,]	10	20	0.10	0.15	115	120	0	NA	NA	NA	NA	NA	NA
[109,]	20	30	-0.15	-0.10	90	95	1	29.35311	-0.12771799	90.90057	NA	NA	NA
[110,]	20	30	-0.15	-0.10	95	100	0	NA	NA	NA	NA	NA	NA
[111,]	20	30	-0.15	-0.10	100	105	0	NA	NA	NA	NA	NA	NA
[112,]	20	30	-0.15	-0.10	105	110	0	NA	NA	NA	NA	NA	NA
	Xa	Xb	Ya	Yb	Za	Zb	Freq.	Xmean	Ymean	Zmean	SDX	SDY	SDZ
[113,]	20	30	-0.15	-0.10	110	115	0	NA	NA	NA	NA	NA	NA
[114,]	20	30	-0.15	-0.10	115	120	0	NA	NA	NA	NA	NA	NA
[115,]	20	30	-0.10	-0.05	90	95	441	25.58731	-0.05624184	91.32552	3.06111689	0.0057974332	1.3400102
[116,]	20	30	-0.10	-0.05	95	100	207	27.63018	-0.05954629	97.94626	1.51585763	0.0057969189	1.4116195
[117,]	20	30	-0.10	-0.05	100	105	294	24.41910	-0.05727797	102.65417	2.48644020	0.0062863287	1.3861469
[118,]	20	30	-0.10	-0.05	105	110	102	22.19924	-0.05690898	106.81683	1.78892286	0.0093851080	1.1291719
[119,]	20	30	-0.10	-0.05	110	115	0	NA	NA	NA	NA	NA	NA
[120,]	20	30	-0.10	-0.05	115	120	0	NA	NA	NA	NA	NA	NA
[121,]	20	30	-0.05	0.00	90	95	1543	25.14817	-0.03284250	91.47858	2.84358718	0.0127767089	1.2963219
[122,]	20	30	-0.05	0.00	95	100	299	26.41624	-0.03072258	97.64272	2.72482713	0.0143005157	1.4402260
[123,]	20	30	-0.05	0.00	100	105	480	25.87266	-0.03655897	102.74904	2.56497977	0.0119733414	1.3838425
[124,]	20	30	-0.05	0.00	105	110	339	23.97070	-0.03305230	106.87958	2.66010340	0.0118853746	1.3208249
[125,]	20	30	-0.05	0.00	110	115	5	20.64504	-0.01628047	110.20994	0.34198076	0.0064099127	0.1346243
[126,]	20	30	-0.05	0.00	115	120	0	NA	NA	NA	NA	NA	NA
[127,]	20	30	0.00	0.05	90	95	526	25.40746	0.02470667	91.55937	2.79902959	0.0155219106	1.3612545
[128,]	20	30	0.00	0.05	95	100	141	24.84655	0.02405214	97.58422	2.80420293	0.0122034652	1.5380123
[129,]	20	30	0.00	0.05	100	105	121	24.53027	0.02354988	102.54458	3.08130787	0.0141468932	1.4076984
[130,]	20	30	0.00	0.05	105	110	94	24.22483	0.02634909	107.02449	3.13507541	0.0149024527	1.5888752
[131,]	20	30	0.00	0.05	110	115	10	20.85564	0.02338224	110.50799	0.62658005	0.0143086757	0.5905112
[132,]	20	30	0.00	0.05	115	120	0	NA	NA	NA	NA	NA	NA
[133,]	20	30	0.05	0.10	90	95	577	25.41640	0.07561606	91.48809	2.85600190	0.0137902656	1.3156738
[134,]	20	30	0.05	0.10	95	100	150	26.17170	0.07422201	97.81393	2.93403987	0.0147269534	1.4042185
[135,]	20	30	0.05	0.10	100	105	190	25.80343	0.07850547	102.77482	2.67334177	0.0152272486	1.4688478
[136,]	20	30	0.05	0.10	105	110	150	24.29445	0.07910979	107.04487	2.98330305	0.0134262831	1.2937581
[137,]	20	30	0.05	0.10	110	115	2	20.91357	0.06017795	110.09731	0.05530188	0.0005370115	0.1147636
[138,]	20	30	0.05	0.10	115	120	0	NA	NA	NA	NA	NA	NA
[139,]	20	30	0.10	0.15	90	95	391	25.70158	0.11841832	91.47724	2.77093498	0.0118616787	1.2744081
[140,]	20	30	0.10	0.15	95	100	32	26.89286	0.11027493	98.31656	3.71312913	0.0069507826	1.4051305
	Xa	Xb	Ya	Yb	Za	Zb	Freq.	Xmean	Ymean	Zmean	SDX	SDY	SDZ
[141,]	20	30	0.10	0.15	100	105	96	26.59296	0.11123041	103.11455	2.2041344	0.007345034	1.3125494
[142,]	20	30	0.10	0.15	105	110	34	25.54849	0.10519758	106.70886	2.0058092	0.004547576	0.9675415
[143,]	20	30	0.10	0.15	110	115	0	NA	NA	NA	NA	NA	NA
[144,]	20	30	0.10	0.15	115	120	0	NA	NA	NA	NA	NA	NA
[145,]	30	40	-0.15	-0.10	90	95	1	30.90823	-0.13778000	90.83632	NA	NA	NA
[146,]	30	40	-0.15	-0.10	95	100	1	36.74875	-0.10943297	95.35613	NA	NA	NA
[147,]	30	40	-0.15	-0.10	100	105	0	NA	NA	NA	NA	NA	NA
[148,]	30	40	-0.15	-0.10	105	110	0	NA	NA	NA	NA	NA	NA
[149,]	30	40	-0.15	-0.10	110	115	0	NA	NA	NA	NA	NA	NA
[150,]	30	40	-0.15	-0.10	115	120	0	NA	NA	NA	NA	NA	NA
[151,]	30	40	-0.10	-0.05	90	95	351	32.96127	-0.05919163	92.36317	1.9319141	0.007247994	1.3308019
[152,]	30	40	-0.10	-0.05	95	100	158	32.24046	-0.05692647	96.84766	1.9149164	0.006501244	1.3141884
[153,]	30	40	-0.10	-0.05	100	105	20	31.34962	-0.05469370	100.66496	1.1177547	0.002905186	0.5034622
[154,]	30	40	-0.10	-0.05	105	110	4	33.41797	-0.08616048	106.94320	1.7509089	0.012956568	0.0000000
[155,]	30	40	-0.10	-0.05	110	115	0	NA	NA	NA	NA	NA	NA
[156,]	30	40	-0.10	-0.05	115	120	0	NA	NA	NA	NA	NA	NA
[157,]	30	40	-0.05	0.00	90	95	915	34.42814	-0.03291482	91.91323	2.7979118	0.013006963	1.3828572
[158,]	30	40	-0.05	0.00	95	100	503	34.30919	-0.03366839	97.43978	2.5135806	0.011904584	1.4727640
[159,]	30	40	-0.05	0.00	100	105	188	32.59171	-0.02810804	101.72881	2.1597771	0.013772699	1.1900754
[160,]	30	40	-0.05	0.00	105	110	12	30.78726	-0.01494332	106.57849	1.2134050	0.008825315	0.6251899
[161,]	30	40	-0.05	0.00	110	115	0	NA	NA	NA	NA	NA	NA
[162,]	30	40	-0.05	0.00	115	120	0	NA	NA	NA	NA	NA	NA
[163,]	30	40	0.00	0.05	90	95	300	35.08283	0.02363659	91.57366	3.1857184	0.014130807	1.3907210
[164,]	30	40	0.00	0.05	95	100	112	36.97215	0.02381332	97.55406	2.3496555	0.013723173	1.4070299
[165,]	30	40	0.00	0.05	100	105	92	33.08970	0.02516873	102.20112	2.0813053	0.013791870	1.3915647
[166,]	30	40	0.00	0.05	105	110	30	30.91833	0.02615417	106.96388	0.6149632	0.016091264	0.8492073
[167,]	30	40	0.00	0.05	110	115	0	NA	NA	NA	NA	NA	NA
[168,]	30	40	0.00	0.05	115	120	0	NA	NA	NA	NA	NA	NA
	Xa	Xb	Ya	Yb	Za	Zb	Freq.	Xmean	Ymean	Zmean	SDX	SDY	SDZ
[169,]	30	40	0.05	0.10	90	95	395	34.88522	0.07698543	91.76463	3.1383308	0.014833697	1.4085400
[170,]	30	40	0.05	0.10	95	100	191	35.45889	0.07912990	97.46175	2.8857120	0.015228591	1.4383188
[171,]	30	40	0.05	0.10	100	105	98	33.13754	0.07452610	102.16226	2.4482003	0.014001707	1.2998054
[172,]	30	40	0.05	0.10	105	110	15	30.52211	0.07008727	106.58207	0.4907504	0.012595453	0.7395400
[173,]	30	40	0.05	0.10	110	115	0	NA					

[178,]	30	40	0.10	0.15	105	110	0	NA	NA	NA	NA	NA	NA	NA	NA
[179,]	30	40	0.10	0.15	110	115	0	NA	NA	NA	NA	NA	NA	NA	NA
[180,]	30	40	0.10	0.15	115	120	0	NA	NA	NA	NA	NA	NA	NA	NA
[181,]	40	50	-0.15	-0.10	90	95	0	NA	NA	NA	NA	NA	NA	NA	NA
[182,]	40	50	-0.15	-0.10	95	100	1	43.66970	-0.10746161	96.20311	NA	NA	NA	NA	NA
[183,]	40	50	-0.15	-0.10	100	105	0	NA	NA	NA	NA	NA	NA	NA	NA
[184,]	40	50	-0.15	-0.10	105	110	0	NA	NA	NA	NA	NA	NA	NA	NA
[185,]	40	50	-0.15	-0.10	110	115	0	NA	NA	NA	NA	NA	NA	NA	NA
[186,]	40	50	-0.15	-0.10	115	120	0	NA	NA	NA	NA	NA	NA	NA	NA
[187,]	40	50	-0.10	-0.05	90	95	1	40.31201	-0.05649714	91.97546	NA	NA	NA	NA	NA
[188,]	40	50	-0.10	-0.05	95	100	5	42.06787	-0.07684567	95.59445	1.7848030	0.014908175	0.4738662	NA	NA
[189,]	40	50	-0.10	-0.05	100	105	0	NA	NA	NA	NA	NA	NA	NA	NA
[190,]	40	50	-0.10	-0.05	105	110	0	NA	NA	NA	NA	NA	NA	NA	NA
[191,]	40	50	-0.10	-0.05	110	115	0	NA	NA	NA	NA	NA	NA	NA	NA
[192,]	40	50	-0.10	-0.05	115	120	0	NA	NA	NA	NA	NA	NA	NA	NA
[193,]	40	50	-0.05	0.00	90	95	50	40.81429	-0.01600081	92.50088	0.6677293	0.011574587	1.0271954	NA	NA
[194,]	40	50	-0.05	0.00	95	100	26	41.31295	-0.02171062	96.19431	1.0599561	0.012346875	1.1569477	NA	NA
[195,]	40	50	-0.05	0.00	100	105	0	NA	NA	NA	NA	NA	NA	NA	NA
[196,]	40	50	-0.05	0.00	105	110	0	NA	NA	NA	NA	NA	NA	NA	NA
	Xa	Xb	Ya	Yb	Za	Zb	Freq.	Xmean	Ymean	Zmean	SDX	SDY	SDZ		
[197,]	40	50	-0.05	0.00	110	115	0	NA	NA	NA	NA	NA	NA	NA	NA
[198,]	40	50	-0.05	0.00	115	120	0	NA	NA	NA	NA	NA	NA	NA	NA
[199,]	40	50	0.00	0.05	90	95	91	41.21204	0.02538546	92.25815	0.8805246	0.013929374	1.2106785	NA	NA
[200,]	40	50	0.00	0.05	95	100	29	41.68350	0.02876112	96.24553	1.1876159	0.013118103	1.3434457	NA	NA
[201,]	40	50	0.00	0.05	100	105	2	40.23429	0.02719921	100.39902	0.1075136	0.003101248	0.2873086	NA	NA
[202,]	40	50	0.00	0.05	105	110	0	NA	NA	NA	NA	NA	NA	NA	NA
[203,]	40	50	0.00	0.05	110	115	0	NA	NA	NA	NA	NA	NA	NA	NA
[204,]	40	50	0.00	0.05	115	120	0	NA	NA	NA	NA	NA	NA	NA	NA
[205,]	40	50	0.05	0.10	90	95	84	41.32019	0.07293715	92.17145	1.0185664	0.014116678	1.1640512	NA	NA
[206,]	40	50	0.05	0.10	95	100	30	41.48600	0.07328170	96.37874	1.1402870	0.014498911	1.4423220	NA	NA
[207,]	40	50	0.05	0.10	100	105	1	40.24409	0.05655807	100.19586	NA	NA	NA	NA	NA
[208,]	40	50	0.05	0.10	105	110	0	NA	NA	NA	NA	NA	NA	NA	NA
[209,]	40	50	0.05	0.10	110	115	0	NA	NA	NA	NA	NA	NA	NA	NA
[210,]	40	50	0.05	0.10	115	120	0	NA	NA	NA	NA	NA	NA	NA	NA
[211,]	40	50	0.10	0.15	90	95	25	40.96155	0.11194399	92.19795	0.6704609	0.007162141	0.9908713	NA	NA
[212,]	40	50	0.10	0.15	95	100	14	41.09576	0.10910884	95.79469	0.7155374	0.008432815	0.5319398	NA	NA
[213,]	40	50	0.10	0.15	100	105	0	NA	NA	NA	NA	NA	NA	NA	NA
[214,]	40	50	0.10	0.15	105	110	0	NA	NA	NA	NA	NA	NA	NA	NA
[215,]	40	50	0.10	0.15	110	115	0	NA	NA	NA	NA	NA	NA	NA	NA
[216,]	40	50	0.10	0.15	115	120	0	NA	NA	NA	NA	NA	NA	NA	NA

>

D.2 S-PLUS CODE FOR CRACK INITIATION SIMULATION

Several functions were written using S-PLUS to complete the simulation procedure introduced in Chapter 6. The `stnregfunc()` is a function that calculates the parameters of the bi-normal function using the hourly data set of the (T_b, g, sg, av, ac) pairs. The `findsolnr()` is a utility function to find the maximum tensile strain position of the bi-normal function. The `findmatstns()` is a function to calculate the tensile strains at different wander positions for each hour. Once the strains have been calculated for each hour, the fatigue life for each wander position at any time can be estimated according to the laboratory obtained fatigue life equation. With these fatigue lives, a function named `ratiomat()` computes the cumulative fatigue damage based on Miner's Law. Detailed information of these functions is listed below.

```
>findsolnr<-function(m1,m2,si)
{
# Newton-Raphson method
p<-0.001
repeat{
  fp<-p+exp((p^2-(m2+p-m1)^2)/2/si^2)*(m2+p-m1)
  flp<-1+exp((p^2-(m2+p-m1)^2)/2/si^2)*(1+(m2+p-m1)*(m1-m2))/si^2)
  newp<-p-fp/flp
  if(abs(p-newp)<0.0001)
    break
  else{
    p<-newp
    next
  }
}
result<-newp+m2
result
}

>findoffsets<-function(m1,m2,si,aa,offsets)
{
center<-findsolnr(m1,m2,si)
result<-NULL
for(i in offsets){
  if(i!=0)
    x<-center-i
  else x<-center
  result<-c(result,aa/si/(2*pi)^0.5*(exp(-(x-m1)^2/2/si^2)+exp(-(x-m2)^2/2/
    si^2)))
}
result
}

>findstns<-function(x)
{
m1<-x[1]
m2<-x[2]
si<-x[3]
aa<-x[4]
xrange<-0.0254*seq(-5,5,len=11)
}
```

```

result<-findoffsets(m1,m2,si,aa,xrange)
result
}

>findmatstns<-function(coef)
{
t(apply(coef,1,findstns))
}

>stnregfunc<-function(tb,g,sg,av,ac)
{
# dat: a matrix contains columns: tb,g,sg
# av: percent air-void content(either a vector or a number)
# ac: percent asphalt content (either a vector or a number)
# xml:coef. matrix as a function of
# c(1,tbg,tbsg,tbg^2,tbsg^2,g,sg,av,ac,tbg*av,tbsg*av,tbg*ac,tbsg*ac,av*ac)
# xm2:m2 coef. matrix as a function of m1 in terms of c(1,m1)
# xsi:si coef. matrix as a function of m1 in terms of
# c(1,m1,m1^2,m1^3,m1^4,m1^5,sin(m1/0.01))
# xaa:log(aa) coef. matrix as a function of m1 in terms of
# c(1,m1,m1^2,sin(m1/0.01))
dat<-cbind(tb,g,sg,av,ac)
result<-NULL
myfunc<-function(x)
{
tb<-x[1]
g<-x[2]
sg<-x[3]
av<-x[4]
ac<-x[5]
tbg<-tb*g
tbsg<-tb*sg
xml<-matrix(scan("d:\\westra-1\\general\\coarse\\xml.txt"), nc=6, byrow=T)
xm2<-matrix(scan("d:\\westra-1\\general\\coarse\\xm2.txt"), nc=6, byrow=T)
xsi<-matrix(scan("d:\\westra-1\\general\\coarse\\xsi.txt"), nc=6, byrow=T)
xaa<-matrix(scan("d:\\westra-1\\general\\coarse\\xaa.txt"), nc=6, byrow=T)
varml<-c(1,tbg,tbsg,tbg^2,tbsg^2,g,sg,av,ac,tbg*av,tbsg*av,tbg*ac,tbsg*ac,
av*ac)
if(g<=-0.1&&g>-0.15)
index<-1
else if(g<=-0.05 && g>-0.1)
index<-2
else if(g<=0 && g>-0.05)
index<-3
else if(g<=0.05 && g>0)
index<-4
else if(g<=0.1 && g>0.05)
index<-5
else if(g<=0.15 && g>0.1)
index<-6
m1<-xml[,index]%%varml
varm2<-c(1,m1)
m2<-xm2[,index]%%varm2
varsi<-c(1,m1,m1^2,m1^3,m1^4,m1^5,sin(m1/0.01))
sxi<-xsi[,index]%%varsi
aa<-exp(xaa[,index]%%varml)
sum<-c(m1,m2,si,aa)
sum
}
t(apply(dat,1,myfunc))
}

>ratiomat<-function(matnf,matesal)
{
result<-NULL
result1<-NULL
for(i in 1:11){
result1<-cbind(result1,matesal[,i]/matnf[,i])
}
result<-cumsum(apply(result1,1,sum))
result
}

```

```

}

#=====
#
#       Splus Log for Main Program of Simulation
#
#=====

> # section 5:coarse,AV=8.1,AC=5.63
> tbgsg.coef<-stnregfunc(tbgsg[,1],tbgsg[,2],tbgsg[,3],8.1,5.63)
> dim(tbgsg.coef)
[1] 22627      4
> range(tbgsg.coef[,3])
[1] 0.1354227 0.1937518
> tbgsg.coef5<-tbgsg.coef
> rm(tbgsg.coef)
> dim(tbgsg.coef5)
[1] 22627      4
> stn5<-findmatstns(tbgsg.coef5)
> dim(stn5)
[1] 22627      11
> nf5<-exp(-27.6723-0.0941*8.1+0.654*5.63+0.0331*tbgsg[1:21943,1]-4.5402*log(stn5[1:21943,]))
> dim(nf5)
[1] 21943      11
> ratio5center<-esalcenter/nf5[,6]
> ratio5<-ratiomat(nf5,esal)
> plot(cumsum(esalcenter),cumsum(ratio5center),xlab="cumulative ESALs",ylab="cumulative ratio of
ni/Ni",main="Section 5:coarse,AV=8.1,AC=5.63. 3/3/96-9/3/98")
> points(cumsum(esalcenter),ratio5,col=2)
> abline(h=1)
> text(locator(1),"with no wander")
> text(locator(1),"with WesTrack Wander Pattern",col=2)
> dev.copy(win.printer,file="clipboard",format="metafile")
> dev.off()
>

```

APPENDIX E: WEIBULL USER'S MANUAL

E.1 GENERAL DESCRIPTION

E.1.1 Introduction

With the aid of the results of laboratory fatigue test and the subsequent statistical analyses of the stiffness and Weibull regression equations, the *Weibull* program is written for the purpose of simulating the fatigue performance of asphalt concrete pavement and thus predicting the initiation time of bottom-up type cracking.

The *Weibull* program is specially tailored for WesTrack; in other words, the general consideration of program design is restricted to fit the special data format of WesTrack, especially regarding traffic and wander pattern, pavement structure, and pavement temperature. Another constraint of the *Weibull* program resides in the inheritance of the original limitations of the ELSYM5 program. These limitations can be outlined as follows:(1) the ELSYM5 program is a linear elastic layer program that does not take into account the viscoelastic behavior of asphalt concrete at high temperatures; (2) the ELSYM5 program is a five-layer program, that is, only five layers or less can be input for analysis; and (3) only a limited number of points, namely 10 points of NXY and 10 points of NZ, are allowed to be calculated. These limitations notwithstanding, the ELSYM5 program plays a key role, serving as the “strain engine” to calculate the tensile strains that cause fatigue damage.

Therefore, the *Weibull* program is not a general-purpose program that can handle all different pavement structures. For this *Weibull* program to fit a specific application, the input pavement structure must be made to conform to the five-layer constraint by merging or simplifying pavement layers. The “equivalent layer” method (Ullidtz 1987) may be utilized to achieve this. In the WesTrack simulation, the pavement structure will consist of three sublayers

of asphalt concrete, one base layer, and one subgrade layer. It should be noted that the program's current primary purpose is to predict the initiation time of fatigue cracks occurring at the bottom of asphalt concrete. However, the stiffness deterioration at positions specified with ELSYM5 within an asphalt concrete layer can also be estimated. Another inconvenience encountered in running this program is the mixed input of the International System (SI) and the U.S. Customary System (USCS).

In addition to these circumscriptions, the accuracy of the *Weibull* program is highly dependent on the correctness of the Weibull and stiffness regression equations that are obtained from statistical analysis of laboratory fatigue test results. Hence, a successful prediction necessitates a carefully and completely designed experiment. Although there are many restrictions imposed on the *Weibull* program, the program itself is a program with dynamic and recursive aspects in predicting fatigue performance.

The following sections introduce the concepts and algorithms of how the *Weibull* program is coded, how the input should be prepared, and what outcome will be obtained.

E.1.2 Program Elements and Flow Charts

The central parts of this simulation program are the ELSYM5 strain engine and the Weibull algorithm that will be discussed in the following paragraphs. The strain engine has been tuned by modifying the original ELSYM5 program and turning it into an independent subroutine that can be called by the *Weibull* program and can return the values of tensile strain whenever the layer stiffness is varied due to the change of the pavement temperature and stiffness deterioration. The *Weibull* program was written in Fortran 90 and compiled by the Microsoft FORTRAN Power Station 4.0. The following will briefly describe the major elements, mainly

the modules and their corresponding major subroutines, of the *Weibull* program. Figure E.1 illustrates the relationship between modules and subroutines.

Module Strain_Engine

```
Module Strain_Engine
```

```
use ELSYM5_Program
use Link_List

subroutine strain_calculation(infile_unit, infile, center, wander, nnz, &
                             stn, avgstn)
subroutine make_image(center, old_x, old_stn, new_x, new_stn, d)
subroutine mirror_array(center, n, old_array, new_array)
function interpolation(point1, point2, xpos)
subroutine reduce_matrix(nnz, nnxy, pe_array, new_array)
subroutine find_array_strain(n, list, x, stn)
subroutine find_array_maxpos(n, list, maxpos)
subroutine find_array_avgstn(nz, nxy, list, avgstn)
```

This module will call up two other modules, namely `ELSYM5_Program` and `Link_List`.

As the name of this module implies, this module provides a main subroutine,

`strain_calculation()`, to calculate the intended maximum principal tensile strains.

Module ELSYM5_Program

```
Module ELSYM5_Program
```

```
subroutine tensile_strain(infile_unit, infile, nnz, nnxy, pe_array)
```

The main subroutine in this module is the subroutine `tensile_strain()`. This subroutine is obtained by modifying the original `ELSYM5` program into an independent module

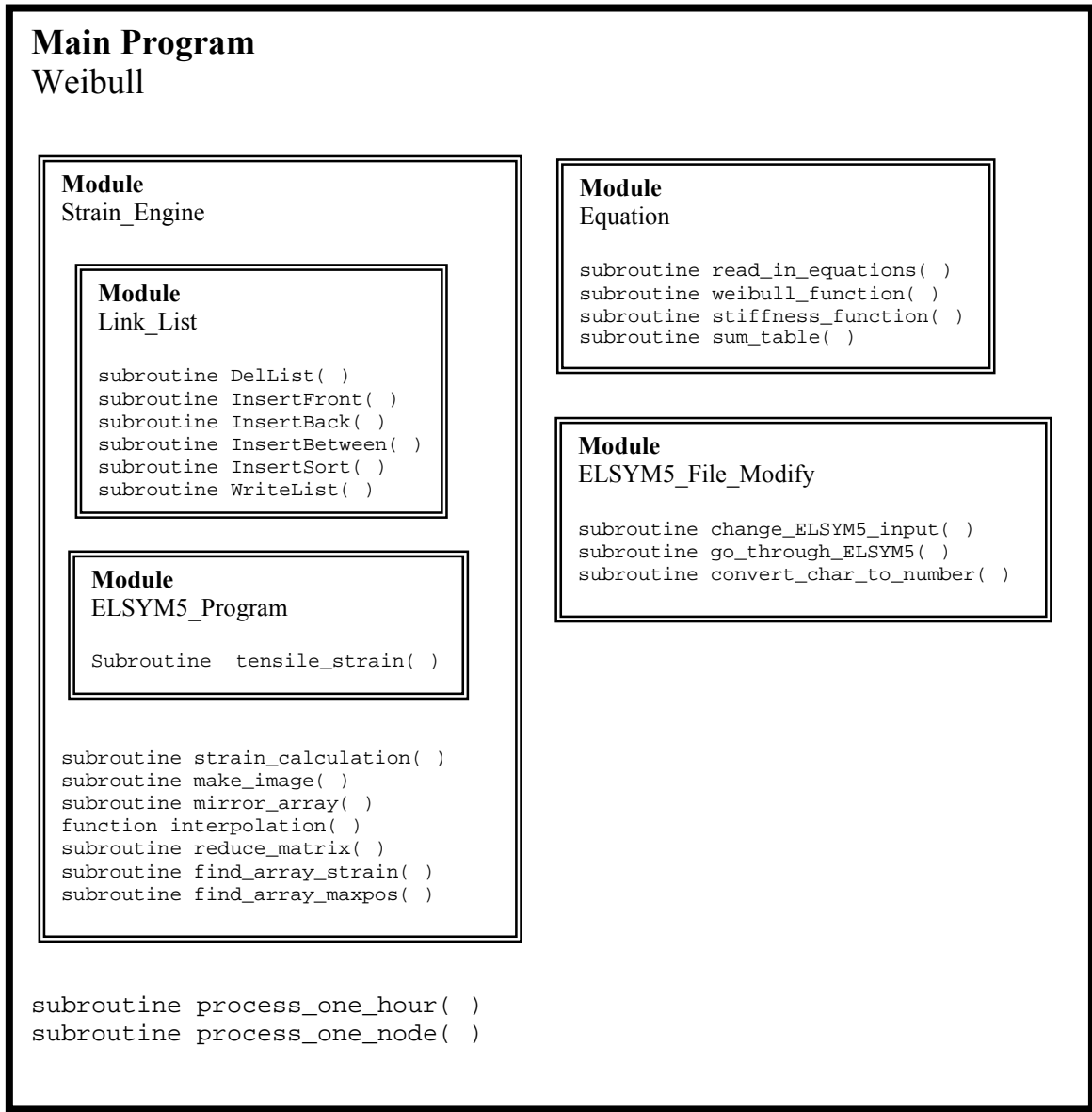

Module
Equation

```

subroutine read_in_equations( )
subroutine weibull_function( )
subroutine stiffness_function( )
subroutine sum_table( )

```

Module
ELSYM5_File_Modify

```

subroutine change_ELSYM5_input( )
subroutine go_through_ELSYM5( )
subroutine convert_char_to_number( )

```

Figure E.1. Module relationship of *Weibull* program.

that can take the same ELSYM5 input file and return an array consisting of the principal tensile strains (including ϵ_1 , ϵ_2 , and ϵ_3) at the locations specified in the input file.

Module Link_List

Module Link_List

```
subroutine Dellist(list)
subroutine InsertFront(head,a,b)
subroutine InsertBack(head,a,b)
subroutine InsertBetween(head,PredPtr,CurrPtr,temp)
subroutine InsertSort(head,a,b)
subroutine WriteList(head)
```

This utility module consists of several useful subroutines to manipulate the linked list.

Six subroutines `Dellist()`, `InsertFront()`, `InsertBack()`, `InsertBetween()`, `InsertSort()`, and `WriteList()` make up the module.

Module Equations

Module equations

```
subroutine read_in_equations(infile_unit,infile,wbl,stif)
subroutine weibull_function(coef_wbl,n0,av,ac,vma,temp,rs4s50,m200,stn,delta_n,phi,dsr)
subroutine sum_table(coef_wbl,n,av,ac,vma,temp,rs4s50,m200,stn,sum,gamma)
subroutine stiffness_function(coef_stif,av,ac,vma,temp,stif)
```

To read in and perform the calculation of the Weibull and stiffness regression equations is the main purpose of this module. The chief disadvantage of this module is the inflexible arrangement of variables of regression equations. Here, for the Weibull regression equation, only the constant term `CONST` and the covariates (or independent variables) `AV`, `AC`, `VMA`, `TEMP`, `RS4S50`, `M200`, `LN(STN)`, `LN(N)`, and `LN(LN(N))` are included. As for the stiffness regression equation, besides the constant term, the covariates included are `AV`, `AC`, `VMA`, and `TEMP`. The sequence of these covariates is very important because the input file of regression equations is

coded according to this order. The input format will be presented as a symmetrical matrix to incorporate the interaction terms.

Module ELSYM5_File_Modify

Module ELSYM5_File_Modify

```
subroutine change_ELSYM5_input(infile_unit,infile,outfile_unit,outfile,stif)
subroutine go_through_ELSYM5(infile_unit,infile,center,nxy,nz,zout)
subroutine convert_char_to_number(string,number)
```

This module serves the purpose of changing the layer stiffness of the ELSYM5 input file whenever the situations that cause stiffness changes exist such as temperature change, and traffic application which leads to the stiffness deterioration.

Main Program Weibull_Simulation

Program Weibull_Simulation

```
Use equations
Use Strain_Engine
Use ELSYM5_File_Modify

subroutine process_one_hour(infile_unit,infile,center,nz,nout,&
                           tb,g,sg,base,av,ac,vma,rs4s50,m200,&
                           coef_wbl,coef_stif,n0,traffic,&
                           cum_reps,phi,sr_old,sr_new,&
                           sr_old_nowander,sr_new_nowander,&
                           sr_old_avg,sr_new_avg,&
                           sr_old_nw_avg,sr_new_nw_avg)

subroutine process_one_node(infile_unit,infile,center,wander,&
                            sg,base,av,ac,vma,temp,rs4s50,m200,s0,&
                            nxy,nz,n0,dn,coef_wbl,cum_reps,phi,&
                            sr_old,sr_new,sr_old_avg,sr_new_avg,&
                            sr_old_nowander,sr_new_nowander,&
                            sr_old_nw_avg,sr_new_nw_avg)
```

The main program `Weibull_Simulation` utilizes three modules, namely `Equations`, `Strain_Engine`, and `ELSYM5_File_Modify`, and contains two subroutines called `process_one_hour()` and `process_one_node()`.

The flowchart of the main program is briefly illustrated in Figure E.2. As can be seen from this flowchart, the essential part is the subroutine `process_one_hour()`, which conducts all the calculations of stiffness ratio. The detailed flowchart of `process_one_hour()` is listed in Figure E.3. From Figure E.4, it will be easy to see why these two main subroutines `process_one_hour()` and `process_one_node()` are named in such a way, as the algorithm is executed “hour-by-hour” and “node-by-node.”

A very important assumption made herein is that, during each hour, the fatigue damage caused by traffic applications at *random* wander positions is equivalent to the fatigue damage accumulated by applying traffic in *sequential and sorted* wander positions. Each node on Figure E.4 represents a wander position that has been subjected to traffic loading. Each hour consists of several or no nodes and has its particular environmental variables. The execution flow is wander-controlled as shown in the direction of arrow in Figure E.4. Notice that the stiffness will be changed node by node due to the stiffness deterioration calculated from the Weibull regression equation; hence, the ELSYM5 strain engine will be called up at each node. The environmental variables are user-defined, updating hourly from the input file.

E.1.3 Weibull Theory

This paragraph presents an approach to simulate the fatigue damage process using the Weibull proportional hazards model (Weibull PH model). Instead of using the Cox Proportional hazards model, the primary benefit of the Weibull PH model is that it can estimate the baseline function, thus making it possible to estimate the parameters of the model using the method of linear regression.

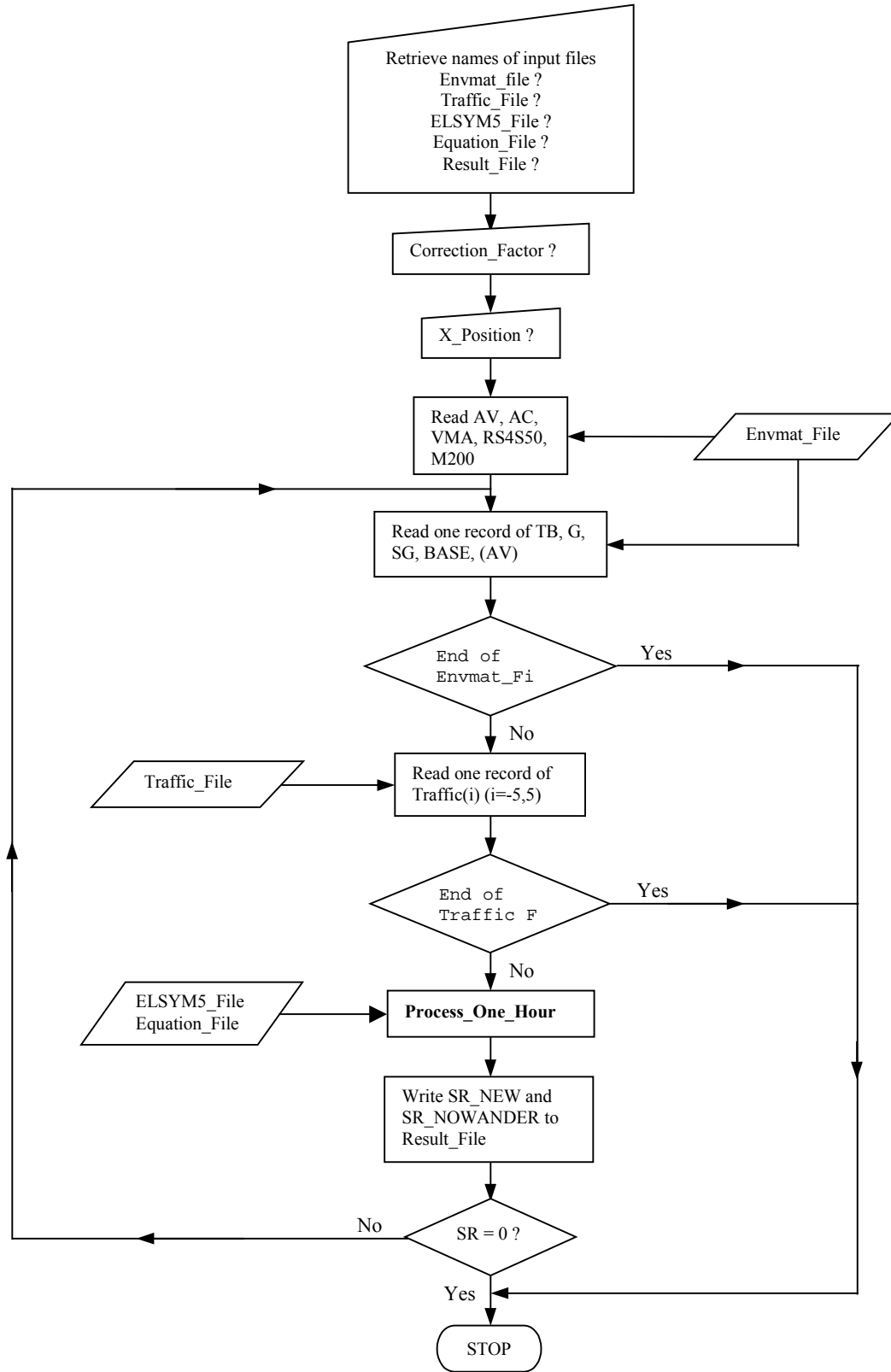

Figure E2. Flow chart of *Weibull* main program.

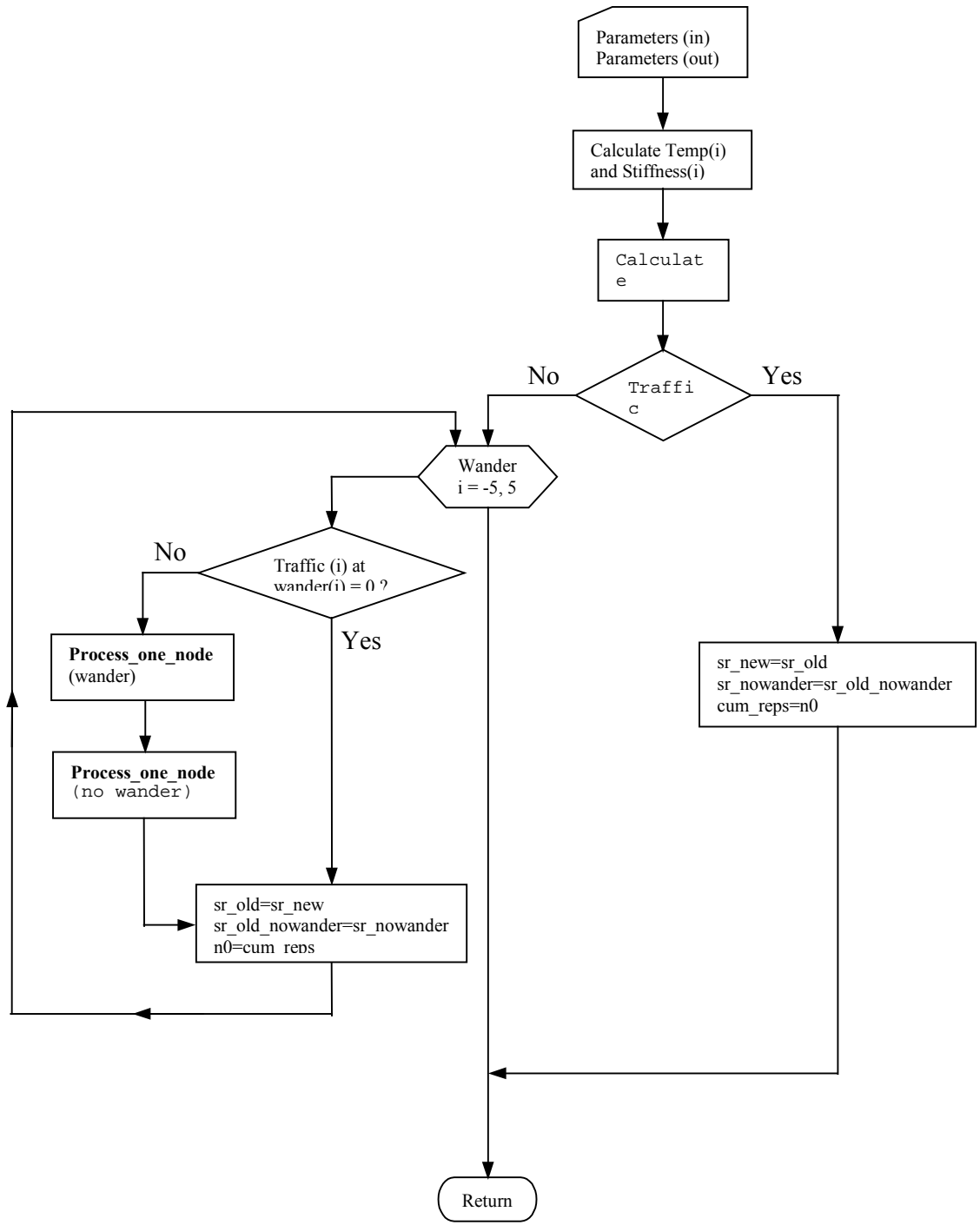
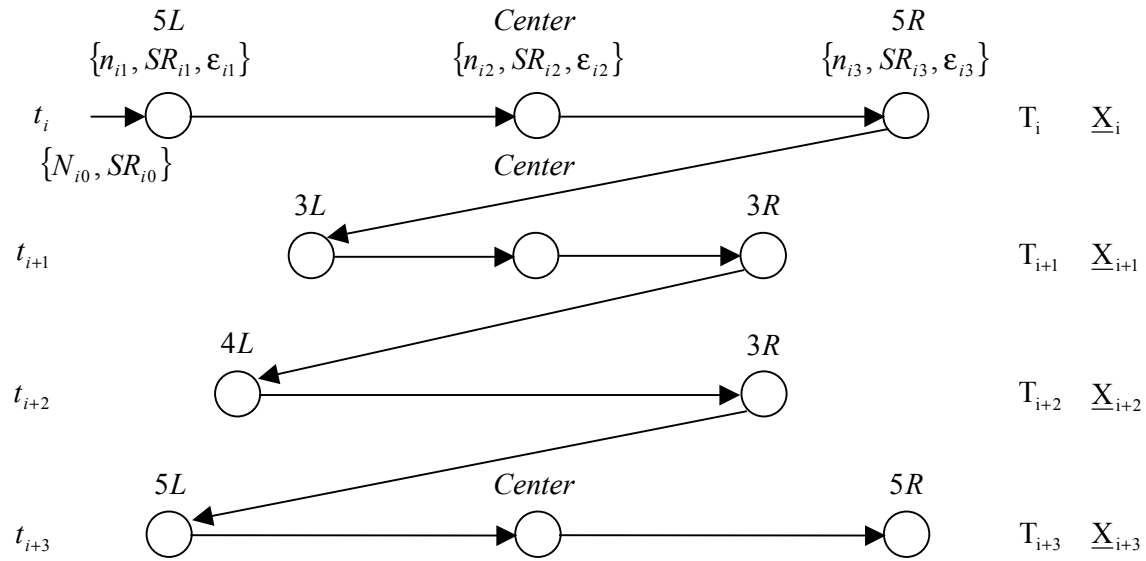

Figure E3. Flow chart of the process_one_hour () subroutine.

Wander Pattern



Where

- t_i = ith time period,
- n_{ij} = trafficking ESALs at time period i and loading location j,
- N_{i0} = cumulative ESALs at time period i and loading location 0,
- SR_{ij} = stiffness ratio at time period i and loading location j,
- ϵ_{ij} = maximum tensile strain at time period i and loading location j,
- T_i = bottom temperature of AC layer at time period i,
- \underline{X}_i = a vector of material variables at time period i,
- NR = the wander (loading center) is N inch to the right of Center,
- NL = the wander is N inch to the left of Center, and
- Center = no wander occurred.

Figure E.4. “Node-by-node” and “hour-by-hour” algorithm of *Weibull* program.

The fatigue damage process is a process combined with the effects of both material and environmental variables. Some of the material variables included are percent air-void content, percent asphalt content, fines content, aggregate type and gradation, and asphalt type. Two notable environmental variables are traffic and temperature. Inferably, the fatigue damage process should be a function of both material and environment variables. The approach shown herein is an attempt to find an adequate function that can reflect the effects of both material and environment variables as contributing to the fatigue failure process through the study of stiffness ratio of laboratory fatigue tests.

Following the definition given by Bogdanoff (1985),-"a stochastic process is a mathematical model of any dynamical process whose evolution with time is governed by probabilistic laws," it was found that the fatigue failure of a laboratory prepared asphalt concrete beam can be appropriately described by the survivor function with a Weibull stochastic density function.

In the following paragraphs, the theoretical background of the Weibull PH model will be briefly described. A set of data from the laboratory temperature sensitivity tests of WesTrack samples is used as an example to illustrate how to apply the Weibull PH model. The comparison of predicted regression results and real data are also included. The approach to applying the Weibull PH model to real pavement is also discussed. It should be mentioned that the derivation process of the Weibull theory and the Weibull accelerated failure time model generally follows Collett's famous book on survival analysis (Collett 1994).

E.1.3.1 Weibull Density Function

It should be noted that the stiffness deterioration is utilized as an index of fatigue damage in this Weibull approach. Stiffness ratio is a normalized quantity that normalizes the stiffness

value relative to its initial stiffness (defined as the stiffness at 50 repetitions) for a specified testing condition. Herein, the stiffness ratio as a function of time is regarded as the survival function in survival analysis. The actual survival time of an individual beam, t , can be regarded as the value of a variable T , which is the survival time random variable. Thus, the different values that T can take have a probability distribution function, called $f(t)$. The distribution function of T is then given by

$$F(t) = P(T < t) = \int_0^t f(u) du$$

The survival function is defined as the probability that the survival time is greater than or equal to t , that is,

$$S(t) = P(T \geq t) = 1 - F(t)$$

The hazard function used in survival analysis is defined as

$$h(t) = \frac{f(t)}{S(t)} = -\frac{d}{dt}(\ln S(t))$$

Here, it is assumed that the probability density function of T follows a two-parameter Weibull density function.

The Weibull density function has the following form:

$$f(t) = \lambda \gamma t^{\gamma-1} \exp(-\lambda t^\gamma) \quad 0 \leq t \leq \infty$$

where λ is the scale parameter and γ is the shape parameter. Therefore,

$$S(t) = 1 - \int_0^t f(u) du = 1 - \int_0^t \lambda \gamma u^{\gamma-1} \exp(-\lambda u^\gamma) du = 1 - \int_0^t \frac{d(\exp(-\lambda u^\gamma))}{du} = \exp(-\lambda t^\gamma)$$

It follows then, that

$$\ln(-\ln(S(t))) = \ln \lambda + \gamma \ln t$$

That is to say, if the Weibull assumption is tenable, then a plot of $\ln(-\ln(\hat{S}(t)))$ against $\ln t$ would give an approximately straight line ($\hat{S}(t)$ is the observed stiffness ratios).

E.1.3.2 Weibull Proportional Hazards Model

To understand the Weibull proportional hazards model, it is necessary to comprehend the nature and significance of the Cox proportional hazards model (Cox 1972). The formula for the Cox PH model is

$$h(t, X) = h_0(t) \exp\left(\sum_{i=1}^p \beta_i X_i\right)$$

where $h_0(t)$ = baseline hazard function and $X = (X_1, X_2, \dots, X_p)$, the covariates.

Another important definition is the hazard ratio (HR) which is defined as the hazard for one individual divided by the hazard for a different individual. Two individuals can be distinguished by the set of different covariates, i.e., the X 's. The Cox PH model assumption requires that the HR stays constant over time:

$$HR = \frac{h(t, X^*)}{h(t, X)} = \text{constant}$$

Recall that the survival function and the hazard function with a Weibull density function can be expressed as

$$S(t) = \exp(-\lambda t^\gamma)$$

$$h(t) = \frac{d(-\ln S(t))}{dt} = \lambda \gamma t^{\gamma-1}$$

For any laboratory fatigue test, imagine that there exists a base line function such that

$$\frac{h_i(t)}{h_0(t)} = \frac{\lambda_i \gamma t^{\gamma-1}}{\lambda_0 \gamma t^{\gamma-1}} = \frac{\lambda_i}{\lambda_0} = \varphi$$

that is,

$$h_i(t) = \varphi h_0(t)$$

The baseline function in the Weibull PH model can be expressed as

$$h_0(t) = \lambda \gamma t^{\gamma-1}$$

The φ cannot be negative as it is a function of test conditions and material variables.

One way to express and ensure the positiveness of any variable's values is to use the exponential function.

Thus, if the survival time has a Weibull distribution, then the hazard function can be as the following form:

$$h(t, X) = \lambda \gamma t^{\gamma-1} \exp\left(\sum_{i=1}^p \beta_i X_i\right)$$

After performing substitution and integration, the Weibull survival function can be obtained as

$$S(t, X) = \exp\left\{-\exp\left(\sum_{i=1}^p \beta_i X_i\right) \lambda t^\gamma\right\}$$

or,

$$\ln(-\ln(S(t, X))) = \sum_{i=1}^p \beta_i X_i + \ln \lambda + \gamma \ln t$$

Thus, the Weibull PH model then transforms into a linear regression model. With the observations of the survival function (stiffness ratio function in this case) and the covariates (material variables, temperature, and test strain level), the parameters can then be estimated.

E.1.3.3 Fitting the Weibull PH Model

The data to which the Weibull PH model is applied is the temperature sensitivity fatigue test data of WesTrack. Table E.1 lists the material variables and the environmental variables as well. Due to the large amount of data of the stiffness ratio for each specimen, they are not itemized here.

Table E.1. Temperature Susceptibility Fatigue Test Results of WesTrack Fine-plus Gradation

Specimen	AV	AC	M200	r.s4s50	Temp.	Strain	Nf
WT12ET	5.0	5.35	6.0	2.92	5.1	0.000196	3872422
WT19ET	8.4	5.41	5.8	2.87	5.1	0.000178	923182
WT19FT	9.3	5.41	5.8	2.87	5.1	0.000296	144082
WT21AT	8.1	6.25	5.4	2.94	5.1	0.000400	25615
WT12FT	4.5	5.35	6.0	2.92	19.8	0.000198	3308278
WT11ET	8.8	5.50	5.5	3.10	19.7	0.000178	1191716
WT12DT	5.3	5.35	6.0	2.92	20.2	0.000298	194603
WT21BT	6.5	6.25	5.4	2.94	19.5	0.000401	25559
WT12AT	7.5	5.35	6.0	2.92	30.1	0.000199	925205
WT19CT	9.4	5.41	5.8	2.87	30.2	0.000181	820324
WT12CT	7.6	5.35	6.0	2.92	30.1	0.000300	174999
WT12BT	8.9	5.35	6.0	2.92	30.1	0.000404	49999

As can be seen in Figure E.5 through Figure E.7, temperature and strain level have significant effects. In addition to this, three important observations can be addressed:

- (a) All slopes are almost the same.
- (b) The intercept ($\ln \lambda + \sum_{i=1}^p \beta_i X_i$) is definitely affected by the material variables and test conditions.
- (c) All the intercepts are negative.

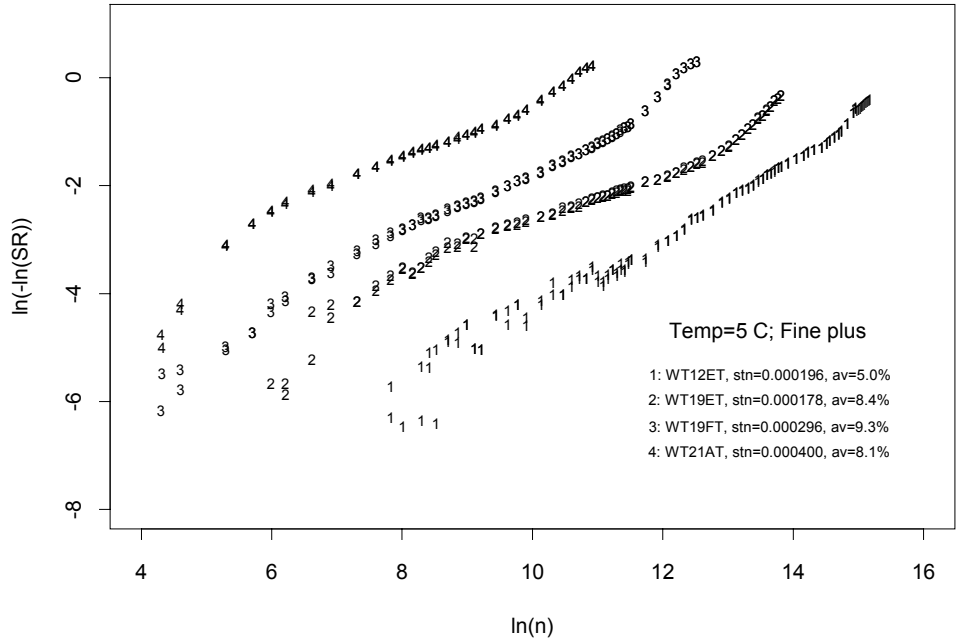

Figure E.5. Weibull curves for fine-plus gradation at temperature 5°C.

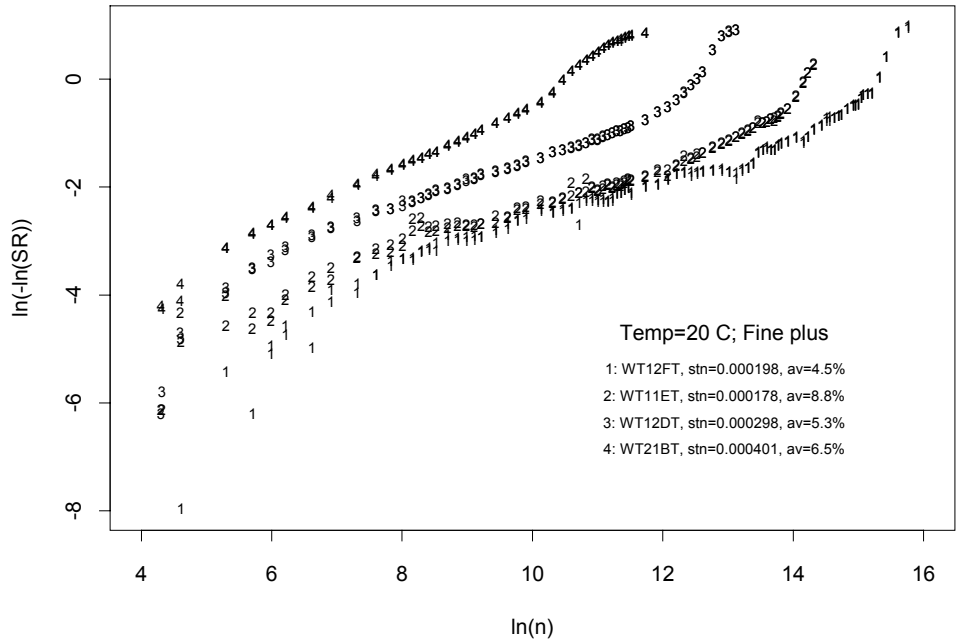

Figure E.6. Weibull curves for fine-plus gradation at temperature 20°C.

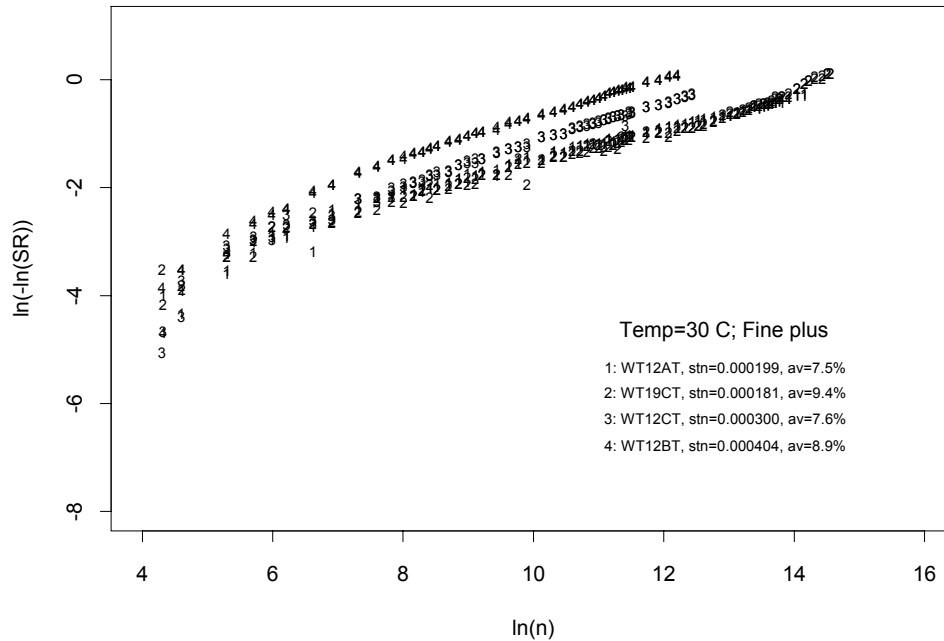

Figure E.7. Weibull curves for fine-plus gradation at temperature 30°C.

The data lines in the plots of $\ln(-\ln(\text{stiffness ratio}))$ against $\ln(\text{repetition})$ of Figures E.5 through E.7 are reasonably straight, indicating that the Weibull assumption is adequate for dealing with the fatigue damage process of laboratory testing. It can be easily seen that in these figures, for the same test temperature, the lines are almost parallel in the order of test strain levels. The higher the test strain level, the bigger the numerical value of the intercept. Also, the spaces among data lines decrease as the test temperature increases, indicating an interaction effect between the temperature and strain level. The following shows the S-PLUS result of regression equation.

Call: lm(formula = log(- log(sr)) ~ av + m200 + r.s4s50 + log(strain) + temp + temp * log(strain) + log(n))

Residuals:
 Min 1Q Median 3Q Max
 -4.525 -0.2541 0.03081 0.3204 1.245

Coefficients:

	Value	Std. Error	t value	Pr(> t)
(Intercept)	31.1304	1.2732	24.4508	0.0000
av	0.1027	0.0099	10.4026	0.0000
m200	-1.3976	0.1131	-12.3546	0.0000
r.s4s50	-2.7272	0.3066	-8.8964	0.0000
log(strain)	2.8252	0.1238	22.8140	0.0000
temp	-0.2448	0.0451	-5.4254	0.0000
log(n)	0.4935	0.0058	84.8145	0.0000
temp:log(strain)	-0.0355	0.0054	-6.6206	0.0000

Residual standard error: 0.5183 on 1369 degrees of freedom
 Multiple R-Squared: 0.8674
 F-statistic: 1279 on 7 and 1369 degrees of freedom, the p-value is 0

Notice that each term in this application model is significant and the multiple R-squared is 0.8674. The final Weibull PH model then is

$$\ln(-\ln(sr)) = \underset{(1.2732)}{31.1304} + \underset{(0.0099)}{0.1027} av - \underset{(0.0451)}{0.2448} temp - \underset{(0.3066)}{2.7272} r.s4s50 - \underset{(0.1131)}{1.3976} m200 + \underset{(0.1238)}{2.8252} \ln(stn) + \underset{(0.0058)}{0.4935} \ln(n) - \underset{(0.0054)}{0.0355} temp \cdot \ln(stn)$$

where

- sr* = stiffness reduction ratio,
- av* = percent air-void content,
- m200* = percent passing #200 (0.075 mm) sieve,
- r.s4s50* = ratio of percent passing #4 (4.75 mm) and #50 (0.3 mm) sieves,
- ln* = natural logarithm,
- stn* = micro strain,
- temp* = test temperature (°C), and
- n* = repetition.

The number in the parentheses is the standard error of regression coefficient. It should be noted that the *av*, *lnstn* and *lnn* have positive coefficients, whereas the *m200*, *r.s4s50*, *temp*, and the interaction term *temp · ln(stn)* have negative coefficients. To interpret the physical meaning of these coefficients, make a simple example of the change of percent air-void content to the effect of stiffness ratio.

Example:

Two mixes, A and B, have the same material and environmental variables except one has 8 % *av*, the other has 5 % *av*, respectively. Thus, to reach the same stiffness ratio, say sr_t ,

$$\text{For mix A: } \ln(-\ln(sr_t)) = C + 0.1027 \cdot 8 + 0.4935 \ln n_A$$

$$\text{For mix B: } \ln(-\ln(sr_t)) = C + 0.1027 \cdot 5 + 0.4935 \ln n_B$$

$$\text{Subtracting formula B from formula A, } 0.1027 \cdot (8 - 5) + 0.4935 \left(\ln \frac{n_A}{n_B} \right) = 0 \Rightarrow \ln \frac{n_A}{n_B} = -0.6243$$

$$\Rightarrow n_A = 0.536 n_B.$$

That is to say that mix B (with 5 % *av*) needs almost twice the time to reach the same stiffness ratio as does mix A. In other words, mix A fails faster than mix B. Since the *av*, $\ln n$ and $\ln n$ have the positive coefficients in the model, their effects to the stiffness reduction are negatively correlated: the higher the values, the quicker the failure. Interestingly, the temperature has a negative coefficient in the model; therefore, the higher the temperature, the slower the failure. But remember that the temperature range of this application model is from 5°C to 30°C.

Figure E.8 displays the comparison of the application model (solid line in plots) and real data in the plots of $\ln(-\ln(\text{stiffness reduction ratio}))$ against the $\ln(\text{repetition})$ for each specimen. Frankly speaking, the fitting is quite promising and satisfactory. The model seems to capture the main trend of each specimen.

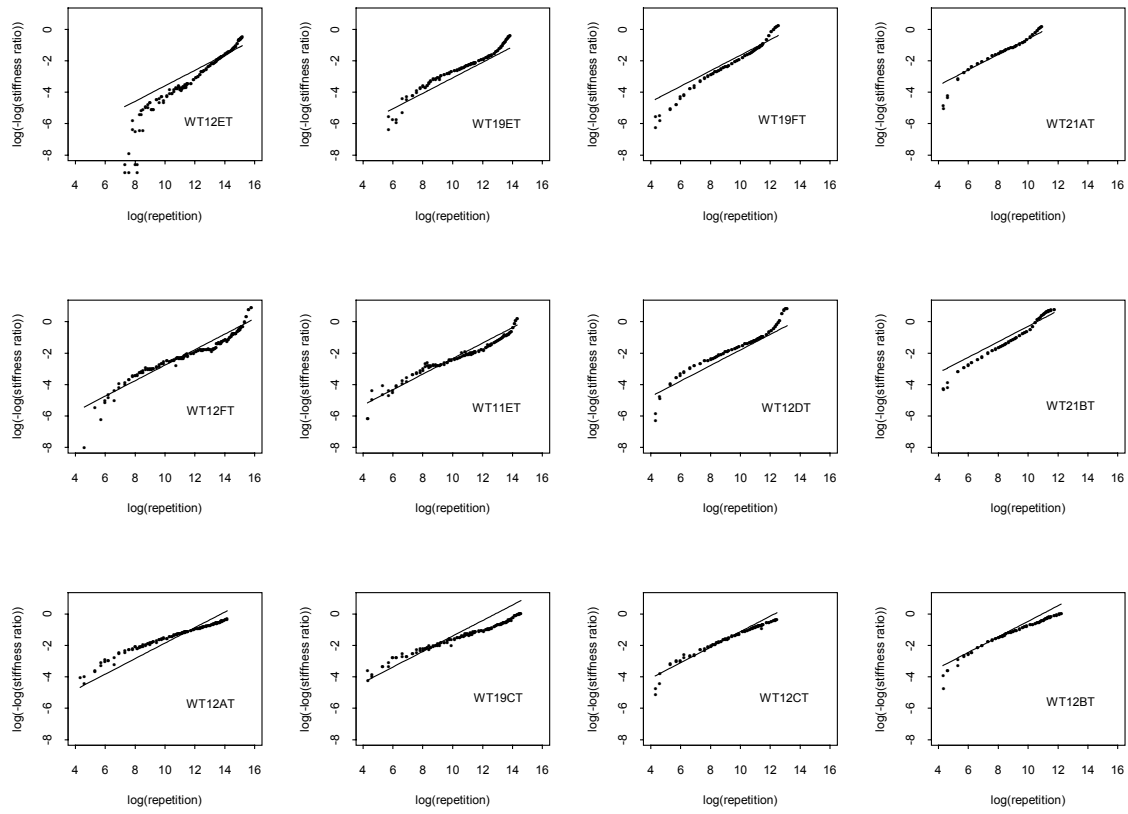

Figure E.8. Weibull regression fitting and real data for fine-plus gradation.

E.1.4 Weibull Accelerated Failure Time Model

The following paragraph will focus on general discussion of the accelerated failure time model. The independent variable, stiffness or stiffness ratio of asphalt concrete, as measured in the field is assumed to act multiplicatively on the time-scale relative to the stiffness observed in the laboratory. Intuitively the model can be utilized as a comparison measurement in terms of the speed of the stiffness deterioration process between the fatigue test conducted in the laboratory and fatigue performance in the field. It is postulated that the stiffness deterioration process on the field pavement follows a Weibull function.

Under an accelerated failure time model, the survival time of a beam tested in the laboratory is taken to be a multiple of the survival time obtained from the back-calculation in field. Thus the effect of different boundary conditions is to ‘speed up’ or ‘slow down’ the passage of time. Under this assumption, the probability that a beam tested in the laboratory survives beyond time t is the probability that a pavements performance in the field survives beyond time ϕt , where ϕ is an unknown positive constant. The ϕ is also identified as a correction factor to be multiplied by the laboratory fatigue life to obtain the corresponding fatigue life in the field, and is mainly caused by the differences of boundary conditions between laboratory and field.

Now let $S_{Lab}(t)$ and $S_{Field}(\phi t)$ be the survival functions for laboratory and field respectively. Then, the accelerated failure time model specifies that

$$S_{Lab}(t) = S_{Field}(\phi t) \quad (1)$$

for any value of the survival time t .

According to the relationship among the survival function $S(t)$, probability density function $f(t)$, and hazard function $h(t)$, the relationship between the density and hazard functions can be derived as follows:

Take the derivative with respect to time of Equation 1,

$$\frac{dS_{Lab}(t)}{dt} = \frac{dS_{Field}(\phi t)}{dt}$$

Then,

$$f_{Lab}(t) = \phi f_{Field}(\phi t)$$

According to the definition of hazard function,

$$\frac{f_{Lab}(t)}{S_{Lab}(t)} = \frac{\phi f_{Field}(\phi t)}{S_{Field}(\phi t)}$$

one obtains

$$h_{Lab}(t) = \phi h_{Field}(\phi t)$$

that is,

$$h_{Field}(t) = \phi^{-1} h_{Lab}(\phi^{-1} t)$$

The parameter ϕ must be non-negative; therefore, it is convenient to set ϕ as an exponential function e^β . This Weibull function is not to be confused with a Weibull distribution, for the fatigue damage process is a consecutive process with time, which should not be considered as the survival time value arrived at by following a Weibull distribution. The stiffness deterioration process, namely the survival function or the fatigue damage process, of laboratory fatigue tests is assumed to follow a Weibull function and its base line hazard function is

$$h_{Lab}(t) = \lambda \gamma t^{\gamma-1}$$

Under the assumption that the stiffness deterioration process of laboratory fatigue tests is a Weibull function with scale parameter λ and the shape parameter γ , the hazard function of the accelerated failure time model for field performance can be represented as

$$h_{Field}(t) = \phi^{-1} h_{Lab}(\phi^{-1}t) = \phi^{-1} \lambda \gamma (\phi^{-1}t)^{\gamma-1} = \phi^{-\gamma} \lambda \gamma t^{\gamma-1}$$

and its survival function can be represented as

$$S_{Field}(t) = \exp\left(-\int_0^t h_{Field}(u) du\right) = \exp\left(-\int_0^t \phi^{-\gamma} \lambda \gamma u^{\gamma-1} du\right) = \exp(-\lambda \phi^{-\gamma} t^\gamma)$$

i.e.,

$$\ln(-\ln(S_{Field}(t))) = \ln \lambda - \gamma \ln \phi + \gamma \ln t$$

which is a Weibull function with scale parameter $\lambda \phi^{-\gamma}$ and the shape parameter γ .

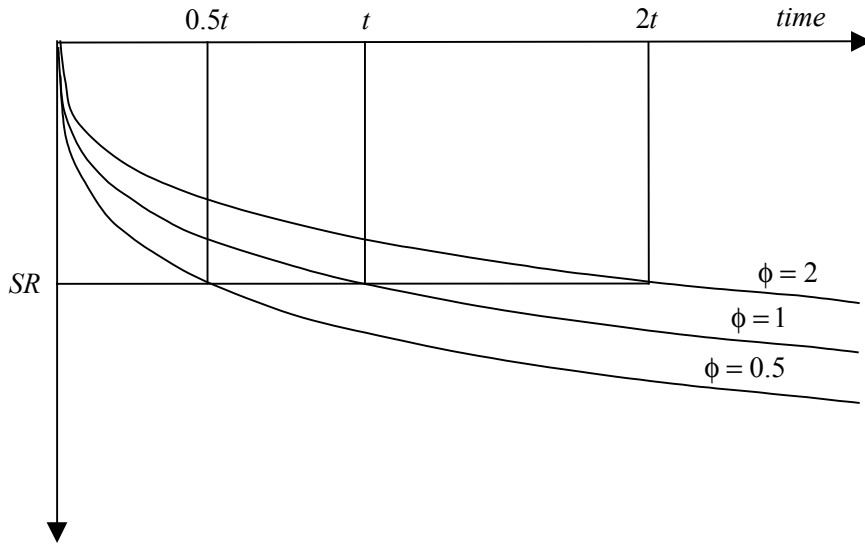

Figure E.9. Weibull accelerated failure time model with different correction factors.

Therefore, if the stiffness deterioration processes of asphalt concrete in both the field and in the laboratory are following the Weibull function when subjected to the same test conditions (excluding test setup), then according to the Weibull accelerated failure time model $\phi > 1$ will slow down the deterioration process while $0 < \phi < 1$ will accelerate it.

Figure E.9 illustrates why $0 < \phi < 1$ speeds up the deterioration process and $\phi > 1$ slows it. If $\phi = 1$ is taken as a standard curve and termed “standard ϕ curve”, then for the $\phi = 2$ curve, at any given SR value, the survival time is twice that of the standard ϕ curve; namely, if $\phi = 2$, the fatigue life will be twice that of the standard ϕ curve.

E.1.5 Wander Consideration

Instead of having channelized traffic, the wander distribution of tires on a highway along the cross section direction is usually distributed as a normal distribution. The effect of wander to the fatigue performance is significant, as has been demonstrated in previous discussion in Chapter 5 utilizing Miner’s Law. However, without considering the stiffness deterioration of pavement itself and lacking the high temperature fatigue information, it seems that Miner’s approach is too conservative. That is to say the correction factor, which is defined as the ratio of repetitions of the no wander case divided by repetitions of the wander case, tends to overestimate. The *Weibull* program will take the traffic and wander as its input along with the other input files and compute the stiffness ratios both for the cases with wander and without wander. For a specified position, the tensile strain encountered at the bottom of an asphalt concrete layer will be varied with time and wander position as well. Figure E.10 illustrates how to estimate the tensile strain due to the wander at a specified position.

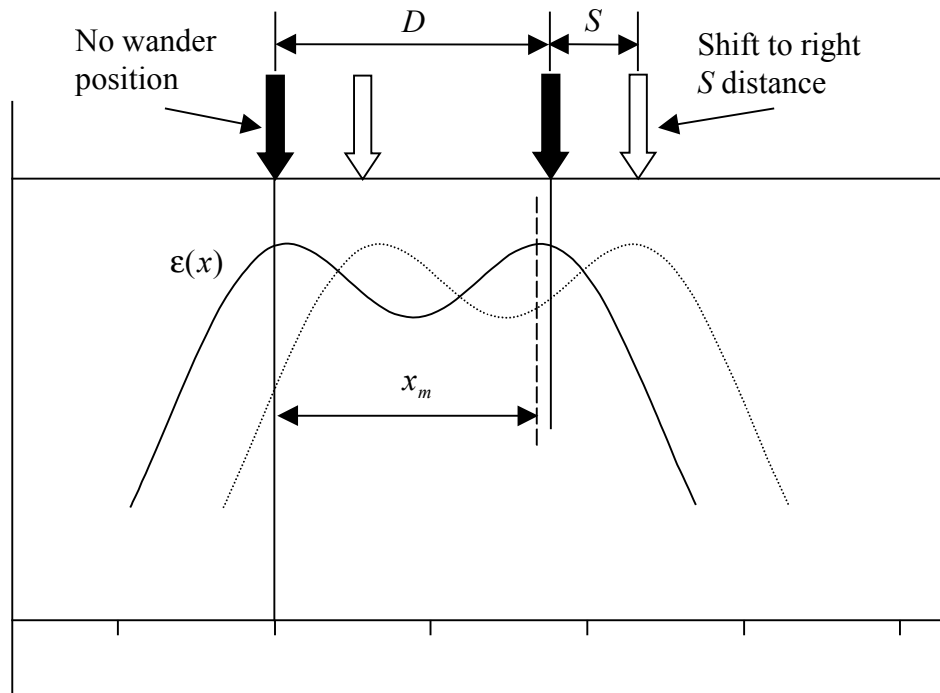

Note: $\epsilon(x_m) = \epsilon(x_m - S)$, if shift to right S distance.
 $\epsilon(x_m) = \epsilon(x_m + S)$, if shift to left S distance.

Figure E.10. Illustration of tensile strain calculation with wander.

E.1.6 Stiffness, Temperature, and Stiffness Ratio

In this Weibull approach, the stiffness ratio is used as an index of fatigue damage. Once the stiffness ratio reaches a certain level, it is said that the crack initiation will occur. The assumption postulated in this Weibull approach is that the fatigue damage of asphalt concrete cannot be recovered once damaged. However, keep in mind that the stiffness ratio is defined as $S(n, \underline{X}, T)/S(0, \underline{X}, T)$, where $S(n, \underline{X}, T)$ is the stiffness of asphalt concrete with mix properties \underline{X} at loading repetition n subjected to temperature T ; when n equals zero means the initial stiffness at temperature T .

It has been identified that temperature affects the stiffness of asphalt concrete. The asphalt concrete loses stiffness at higher temperatures and conversely gains strength when the temperature cools down. Thus both temperature and stiffness varies with time, and the value of stiffness is a relative quantity rather than an absolute one. Instead of an absolute stiffness, the Weibull approach utilizes the stiffness ratio. But, in the calculation of tensile strain, the ELSYM5 program needs an absolute stiffness as an input. To solve this discrepancy, an algorithm needs to be provided to take into account not only the temperature variation but also the stiffness deterioration. It is important to note that this algorithm must maintain the first assumption above.

Two stiffness deterioration curves of laboratory fatigue tests with the same mix are shown in Figure E.11. One is the $S^*(n, \underline{X}, T_2)$ curve at temperature T_2 and the other is the $S(n, \underline{X}, T_1)$ curve at temperature T_1 . Now, if the fatigue test starts at the $S(n, \underline{X}, T_1)$ curve and stops after n_1 applications, then the stiffness ratio will decrease from 1.0 to, say, R_1 . Afterward, if the temperature changes from T_1 to T_2 , then the stiffness will jump from $S(n, \underline{X}, T_1)$ to $S^*(n, \underline{X}, T_2)$. However, before any loading is applied, the stiffness ratio is assumed to maintain at R_1 , that is, the stiffness $S^*(n_1, \underline{X}, T_2)$ equals to $S^*(0, \underline{X}, T_2) \cdot R_1$. Notice that $\Delta S = S^*(n_2, \underline{X}, T_2) - S^*(n_1, \underline{X}, T_2)$. When this equation is divided by $S^*(0, \underline{X}, T_2)$, the difference of stiffness ratio ($\Delta R_{1 \rightarrow 2}$) along the $S^*(n, \underline{X}, T_2)$ curve after applying $n_2 - n_1$ loading repetitions is obtained. Hence, at loading repetition n_2 , the stiffness ratio will be

$$R_2 = R_1 + \Delta R_{1 \rightarrow 2}.$$

One thing should be pointed out: most of time the conventional stiffness equation obtained from laboratory fatigue tests is meant to be the “initial stiffness”, defined as the

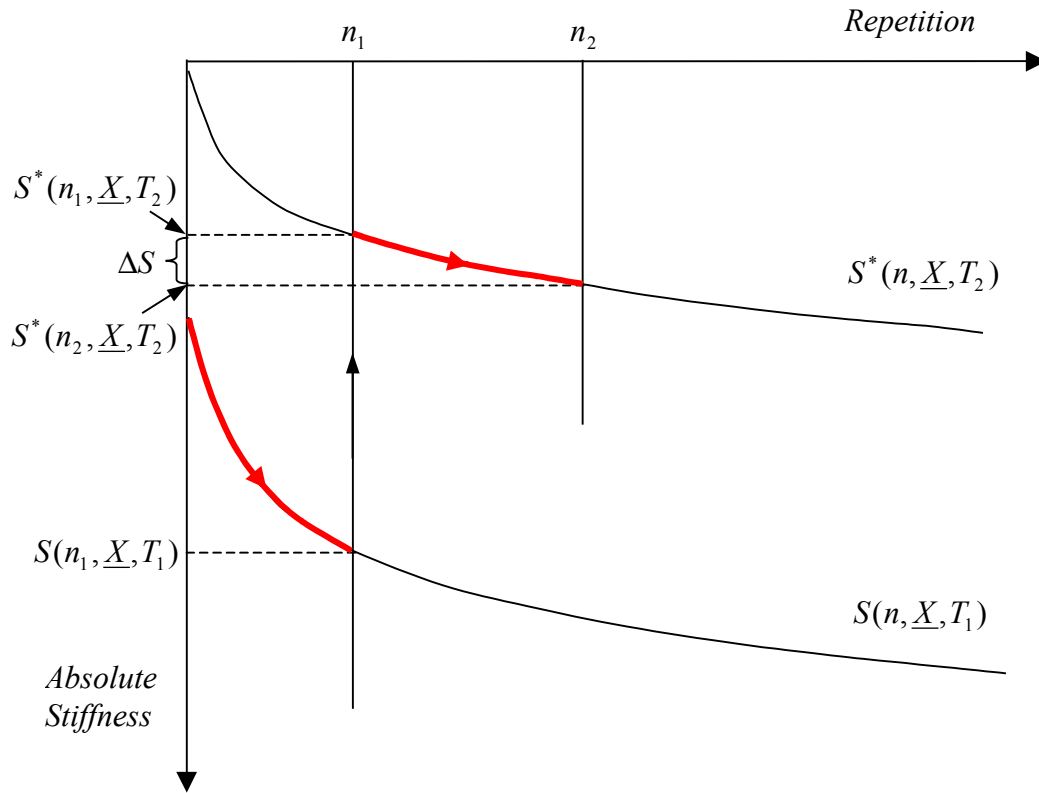

Figure E.11. Relationship between initial stiffness and stiffness ratio.

stiffness at repetition 50 and a function of either material or environmental variables. In the *Weibull* program, the stiffness at any loading repetition and any temperature will be calculated based on the present stiffness ratio and the conventional initial stiffness regression equation described above.

E.1.7 Vehicle Speed and Stiffness

The frequency sweep test is a classic test utilized to find the master curves of the material of interest, especially a thermorheologically simple material such as asphalt concrete. Typical results from the frequency sweep test are shown schematically in Figure E.12, which illustrates the relationship between loading frequency (or loading time) and complex moduli at various

Frequency sweep test: WTCM57-17AB

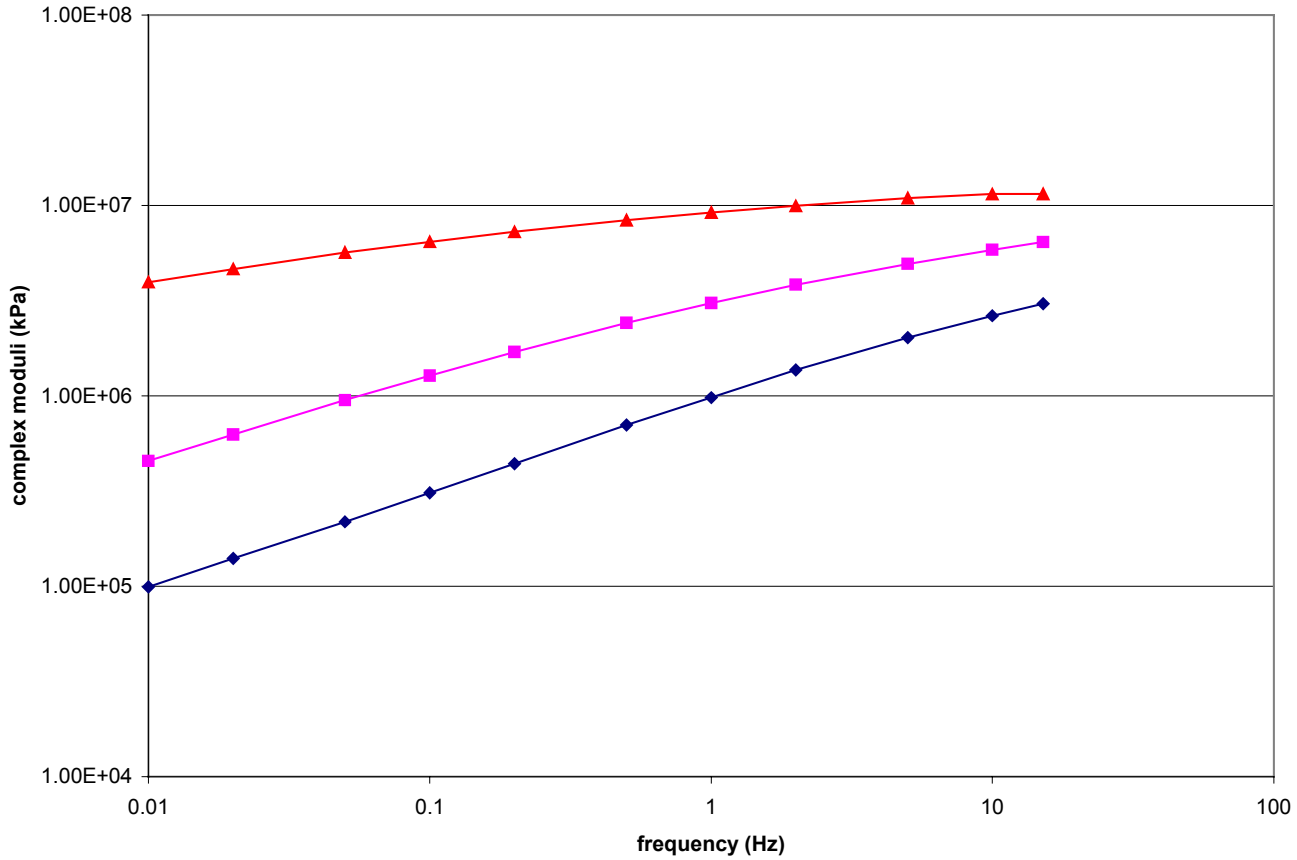

522

Figure E.12. Plot of traditional flexural frequency sweep test at various reference temperatures.

reference temperatures. Thus, for a specific asphalt mix, the complex modulus depends not only on the temperature but also the loading time. In highway trafficking, the various vehicle speeds will result in different loading times on asphalt pavement; accordingly, the asphalt pavement will respond differently in stiffness.

As shown in Figure E.12, the relationship between loading frequency (or loading time) and the stiffness of asphalt concrete is a nonlinear relationship, which is characteristic of a viscoelastic material. This nonlinear relationship seems to be appropriately described by the Gamma function. Note that these obtained complex moduli can be regarded as the initial stiffness without any consideration of deterioration due to traffic loading. Once the initial stiffness is represented by the material variables, temperature, and the loading time (vehicle speed), this will bring up the same issue as in Section E.1.6—initial stiffness and stiffness ratio—when discussing the fatigue performance of asphalt concrete.

E.1.8 Traffic Wander, Traffic Composition, and Vehicle Speed

Several aspects such as traffic wander, traffic composition, and vehicle speed can characterize the applied traffic loading that causes the distress of asphalt concrete pavement. To conduct a simulation of pavement performance, the details of traffic loading must be provided for an accurate prediction. Simulations are generally not intended to monitor the service conditions of a newly constructed or an overlapped asphalt concrete pavement. Therefore, a prudent and thrifty way is to statistically generate a random sequence of data based on either the real or the postulated distributions of wander, composition, and vehicle speed. The following paragraphs illustrate how easily this random sequence can be generated.

The effect of traffic wander on pavement performance is significant, as proved in previous discussion. The fact that various types of trucks will cause differing degrees of damage to pavement is without question. Clearly, traffic composition is another variable to be considered when predicting pavement performance. Vehicle speed is an equivalent term of loading time. From the results of frequency sweep tests, it is recognized that the stiffness of asphalt concrete pavement is affected not only by loading time but also by temperature.

It should be noted that, other than the traffic wander, traffic composition and vehicle speed are excluded in this version of the *Weibull* program.

Table E.2 tabulates the postulated distributions of traffic wander, traffic composition, and vehicle speed. The traffic wander is assumed to be a normal distribution through all the times, whereas the traffic composition and vehicle speed are regarded as category variables with a discrete distribution and changing with time.

Table E.2 The Time-varied Distributions of Wander, Traffic Composition, and Vehicle Speed

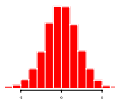
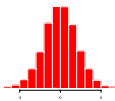
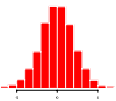
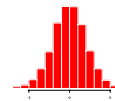
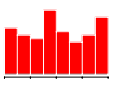
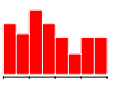
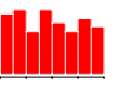
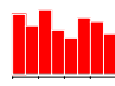
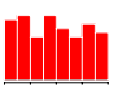
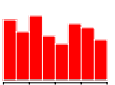
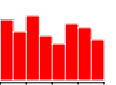
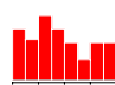
Time Period	t_1	t_2	...	t_i	...	t_n
Total hourly Traffic	N_1	N_2	...	N_i	...	N_n
Wander Distribution			...		...	
Traffic Composition Distribution			...		...	
Vehicle Speed Distribution			...		...	

E.1.9. Random wander generation

Generate a random series of wander positions based on the wander distribution $N(\mu, \sigma)$, assuming a normal distribution with mean μ and standard deviation σ , and the total hourly traffic N_i at the i hour. The procedure to generate such a random series can be summarized in the following steps:

1. Generate a uniform distribution on the interval $[0, 1]$ with N_i samples.
2. For each sample from uniform distribution, map this point through the distribution function of $N(\mu, \sigma)$ to obtain the corresponding wander position followed the $N(\mu, \sigma)$ distribution, that is, $x_p = F^{-1}(p)$, which is shown in Figure E.13.
3. Make the continuous wander positions attracted to the nearest discrete wander locations, as illustrated in Figure E.14. For instance, any x falling in the shade region will be labeled as x_i .
4. Finally, a random series based on the $N(\mu, \sigma)$ wander distribution and total hourly traffic N_i can be easily constructed. If there are p locations of wander, say

$X = \{x_1, x_2, \dots, x_p\}$, then the random series can be expressed, for instance,

$\overbrace{x_1, x_5, x_7, \dots, x_{p-1}, x_3}^{N_i}$, which contain N_i samples and follow a $N(\mu, \sigma)$ distribution.

E.1.10 Random traffic composition generation

Likewise, the previous procedure can generally be applied to any continuous distribution. However, the traffic composition is a category variable in a statistics sense. A similar approach is postulated as follows:

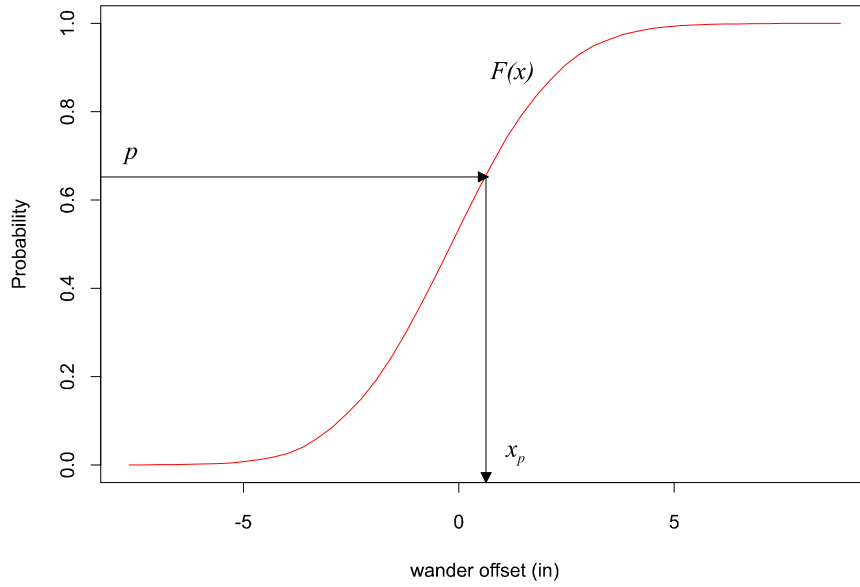

Figure E.13. Using a uniform distribution $U(0,1)$ to generate a set of random numbers with a given distribution function.

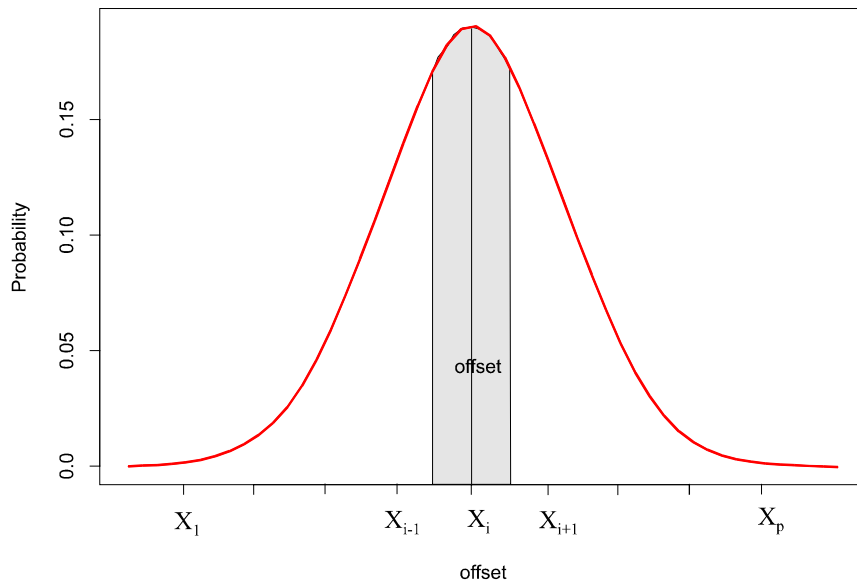

Figure E.14. Assignment of random numbers to the nearest discrete number.

1. First, assume the traffic composition consists of q categories, say

$$\underline{C} = \{c_1, c_2, \dots, c_q\} \text{ and has a known distribution.}$$

2. Based upon the distribution and the total hourly traffic, it is easy to identify the proportion and the corresponding number of each category. That is,

$$\left\{ \overbrace{c_1, \dots, c_1}^{\#(c_1)} \quad \overbrace{c_2, \dots, c_2}^{\#(c_2)} \quad \dots \quad \overbrace{c_q, \dots, c_q}^{\#(c_q)} \right\}, \text{ where } \#(c_i) \text{ is the number of category one}$$

$$\text{and } \sum_k^q \#(c_k) = N_i.$$

3. Randomly permute the series $\left\{ \overbrace{c_1, \dots, c_1}^{\#(c_1)} \quad \overbrace{c_2, \dots, c_2}^{\#(c_2)} \quad \dots \quad \overbrace{c_q, \dots, c_q}^{\#(c_q)} \right\}$, then

$$\overbrace{c_3, c_q, c_1, \dots, c_2, c_3}^{N_i}.$$

E.1.11 Random vehicle speed generation

The vehicle speed can be assumed to have either a continuous or discrete distribution.

Assume there are r various speeds. Using the above-described procedure, a random series of vehicle speed can be formed as follows:

$$\overbrace{s_3, s_r, s_1, \dots, s_2, s_3}^{N_i}$$

Therefore, according to the previously generated random series of wander, composition, and vehicle speed, a combined random series will be constructed as the input of traffic loading of the simulation of pavement performance. Thus,

$$\left\{ \overbrace{\begin{pmatrix} x_1 \\ c_3 \\ s_3 \end{pmatrix} \begin{pmatrix} x_5 \\ c_q \\ s_r \end{pmatrix} \begin{pmatrix} x_7 \\ c_1 \\ s_1 \end{pmatrix} \cdots \begin{pmatrix} x_{p-1} \\ c_2 \\ s_2 \end{pmatrix} \begin{pmatrix} x_3 \\ c_3 \\ s_3 \end{pmatrix}}^{N_i} \right\}$$

where the first element in the set describes a traffic load, caused by a c_3 category truck with vehicle speed s_3 applied on the wander location x_1 .

E.2 Input Data

There are four files requested by the *Weibull* program, the ELSYM5 file, the environment and material file, the traffic file, and the file of stiffness and Weibull regression equations. The details of these input files will be discussed as follows.

E.2.1 ELSYM5 Input File

Basically, this input file has the same format as the ELSYM5 program. Instead of using SI units, ELSYM5's input file still adheres to the original USCS units; namely, the pressure or stiffness has the unit psi, the unit of force is pound, and the distance is in inches. However, these units are changed to SI units internally. In addition, several constraints have been imposed to suit the special purpose of this simulation program.

1. No multiple tasks are allowed in this input file; instead, only one complete task is requested for input. In other words, the input file should consist of the following ELSYM5 key words, namely, PROBLEM, LOADS, XYOUT, ZOUT, and NLAYERS.
2. In preparing this input, note that the simulation program will take the deepest point as the point at the bottom of asphalt concrete layer; in other words, all the specified

points under ZOUT should be located within the asphalt concrete layer. Therefore, it is the user's responsibility to check the compatibility of the farthest point and the thickness of the asphalt concrete layer. In the *Weibull* program, as it is tailored to WesTrack, it is required to input four points of ZOUT. This means that the asphalt concrete layer is divided into three sublayers and each layer has one ZOUT point so that the temperature variation across the asphalt concrete layers can be estimated. The fourth point of ZOUT represents the bottom of asphalt concrete layer and is monitored for the purpose of predicting the initiation time of bottom-up type cracking.

3. Some suggestions about the input of XYOUT are listed below:
 - a. the starting point of the x coordinate should be located to the right side of loading center line but as close as possible, because the tensile strains are symmetrical to the loading center. The *Weibull* program will map mirror-image points using the location of the loading center line as a bisector.
 - b. If possible, input the maximum number of points (i.e., 10 points) under XYOUT to obtain a more accurate simulation result.
 - c. The input range of X coordinates should cover the possible wander range.

It should be noted how the traffic loading system (i.e., the coordinate system) is set up. All the corresponding input should comply with this system.

The same restrictions of the ELSYM5 program will also apply to the input file of this simulation program because the simulation program uses the ELSYM5 program to calculate the principal tensile strains. For instance, there is no input for the interface properties between layers.

The following is a sample file of the ELSYM5 program.

```
PROBLEM 1 1
WesTrack
LOADS 2 5000. 100.
0. 0. 14.0 0.
XYOUT 10
8.0 0. 9.0 0. 10.0 0. 11.0 0. 12.0 0. 13.0 0. 14.0 0. 15.0 0.
17.0 0. 19.0 0.
ZOUT 4
1.0 3.0 5.0 5.99
NLAYERS 5
LAYER 1 1535902. 2.0 .35
LAYER 2 1654497. 2.0 .35
LAYER 3 32000. 2.0 .35
LAYER 4 20000. 12.0 .40
LAYER 5 3850. 0.0 .45
END
```

Above is a sample input of a five-layer system, three sublayers of asphalt concrete, one base layer, and one subgrade layer. The loading center of this example is 7.0 in. and the starting x coordinate of the XYOUT is at 8.0 in.

E.2.2 Environment and Material File

The first line of this input file is a “controlled card” that indicates if the air-void content of the asphalt concrete is varied with time or remains the same during the whole simulation. “1” represents the air-void content and should be input as an independent column right after the subgrade column. “0” means that the air-void content will be assigned the same value throughout the simulation. The intent of this design format is to include and estimate the “traffic compaction” effect on the pavement fatigue performance.

The second line of this input file consists of a set of ordered constant variables, namely (*av*), *ac*, *vma*, *rs4s50*, *m200*, where *av* is the air-void content, *ac* the asphalt content, *vma* the percent voids in mineral aggregate, *rs4s50* the ratio of percent passing at #4 (4.75 mm) sieve to the percent passing at #50 (0.3 mm) sieve, and *m200* is the percent passing #200 (0.075 mm) sieve. These constant variables, excluding *av*, will be regarded as the invariant quantities all the

pavement life. If the first line presents “1”, then the *av* is not going to show up in the second line; conversely, if a “0” is input, *av* should be put at the beginning of the second line. It should be noted that all these constant variables should be input in the order described above.

Starting from the third line, this file will include input of *Tb*, *g*, *sg*, *base*, and (*av*) in order, where *Tb* is the temperature at the bottom of the asphalt concrete, *g* the temperature gradient, *sg* the subgrade modulus, *base* the stiffness of the base layer, and *av* if presented.

Notice that all the input lines of this file are free formatted. The following shows an example of an environmental and material input file.

```

0
6.0 5.0 0.0 3.0 5.0
10.88610236 0.014237795 102.5170364 172.4
10.86551181 0.007225984 102.5170364 172.4
10.80114173 -0.003320472 102.5170364 172.4
10.35346457 -0.009829528 102.5170364 172.4
9.960629921 -0.010391732 102.5170364 172.4
9.617893701 -0.009690748 102.5170364 172.4
9.360629921 -0.010340157 102.3094934 172.4
9.118070866 -0.013825 102.3094934 172.4
8.823543307 -0.012802953 102.3094934 172.4
8.590137795 -0.016741201 102.3094934 172.4
8.264694882 -0.018324154 102.3094934 172.4
7.967151575 -0.020566417 102.3094934 172.4
7.625283465 -0.02307437 102.3094934 172.4
7.286362205 -0.025141457 102.3094934 172.4
6.913775591 -0.02807874 102.3094934 172.4
6.43342126 -0.015802874 102.3094934 172.4
6.345281496 0.019932047 102.3094934 172.4
7.146889764 0.034477756 102.3094934 172.4

```

E.2.3 Traffic File

The traffic file of the *Weibull* program is specifically tailored to the WesTrack traffic pattern. The traffic file contains eleven columns; each column represents one wander location. The wander locations range from 5 inches to the left of loading center (5L) to 5 inches to the right of loading center (5R) with 1-inch spacing. Thus, the first column stands for the wander that is shifted 5 inches to the left of loading center. The number in the sixth column is the traffic with no wander shift. Likewise, the eleventh column means the wander is shifted 5 inches to the right of loading center. One thing to bear in mind is that the traffic has the unit ESAL; however,

it will be converted to repetitions inside the program and will be multiplied by a conversion factor of 0.7633 for the special truck configuration of WesTrack.

The following is an example of the traffic file of WesTrack. The first line shows that three wander locations, 2L, 1R, and 4R, all with traffic 238.2 ESALs are encountered during that hour.

```
0 0 0 238.1818 0 0 238.1818 0 0 238.1818 0
0 0 0 238.1818 0 0 238.1818 0 0 238.1818 0
0 0 0 238.1818 0 0 238.1818 0 0 238.1818 0
0 0 0 238.1818 0 0 238.1818 0 0 238.1818 0
0 0 0 238.1818 0 0 238.1818 0 0 238.1818 0
0 0 0 238.1818 0 0 238.1818 0 0 238.1818 0
0 0 0 238.1818 0 0 238.1818 0 0 238.1818 0
0 0 0 238.1818 0 0 238.1818 0 0 238.1818 0
0 0 0 198.4848333 0 0 198.4848333 0 0 198.4848333 0
0 99.24241667 0 99.24241667 0 0 99.24241667 0 0 99.24241667 0
0 198.4848333 0 198.4848333 0 0 198.4848333 0 0 198.4848333 0
0 0 0 19.84848333 0 0 19.84848333 0 0 19.84848333 0
0 0 0 138.9393833 0 0 138.9393833 0 0 138.9393833 0
```

E.2.4 Stiffness and Weibull regression equations File

The stiffness and Weibull regression equations from the statistic analysis should be prepared according to the format described below:

$$\ln(-\ln(SR)) = c_0 + c_1 av + c_2 ac + c_3 vma + c_4 temp + c_5 rs4s50 + c_6 m200 + c_7 \ln(stn) + c_8 \ln(n) \text{ (or } c_8 \ln(\ln(n))) + \text{two - term interaction}$$

$$\ln(stif) = c_0 + c_1 av + c_2 ac + c_3 vma + c_4 temp + \text{two - term interaction}$$

where

- av* = percent air-void,
- ac* = percent asphalt content,
- vma* = percent aggregate voids,
- temp* = temperature (°C),
- rs4s50* = the ratio of percent passing #4 (4.75 mm) and #50 (0.3 mm) sieves,
- m200* = percent passing #200 (0.075 mm) sieve,
- stn* = strain level (microstrain),
- n* = repetitions,
- SR* = stiffness ratio,
- Stif* = initial stiffness at repetition 50 (MPa),
- ln* = natural logarithm, and
- c_i* = experimentally determined coefficients.

Note that the units used, especially those of initial stiffness, are crucial.

For instance, if one has the following Weibull and stiffness regression equations,

Weibull regression equation:

$$\ln(-\ln(SR)) = 31.1304 + 0.1027av - 0.2448temp - 2.7272rs4s50 - 1.3976m200 + 2.8252 \ln(stn) + 0.4935 \ln(n) - 0.0355temp \cdot \ln(stn)$$

Stiffness regression equation:

$$\ln(stif) = 11.468 - 0.0827av - 0.2285ac - 0.058temp$$

Then, the input for the equation file should be like the following:

```
WEIBULL
const av ac vma temp rs4s50 m200 ln(stn) ln(n)
ln(ln(n))
31.1304 0.0 0.0 0.0 0.0 0.0 0.0 0.0 0.0 0.0
0.0 0.1027 0.0 0.0 0.0 0.0 0.0 0.0 0.0 0.0
0.0 0.0 0.0 0.0 0.0 0.0 0.0 0.0 0.0 0.0
0.0 0.0 0.0 0.0 0.0 0.0 0.0 0.0 0.0 0.0
0.0 0.0 0.0 0.0 -0.2448 0.0 0.0 0.0 0.0 0.0
0.0 0.0 0.0 0.0 0.0 -2.7272 0.0 0.0 0.0 0.0
0.0 0.0 0.0 0.0 0.0 0.0 -1.3976 0.0 0.0 0.0
0.0 0.0 0.0 0.0 -0.0355 0.0 0.0 2.8252 0.0 0.0
0.0 0.0 0.0 0.0 0.0 0.0 0.0 0.0 0.4935 0.0
0.0 0.0 0.0 0.0 0.0 0.0 0.0 0.0 0.0 0.0
STIFFNESS
const av ac vma temp
11.468 0.0 0.0 0.0 0.0
0.0 -0.0827 0.0 0.0 0.0
0.0 0.0 -0.2285 0.0 0.0
0.0 0.0 0.0 0.0 0.0
0.0 0.0 0.0 0.0 -0.058
```

The program only reads from the lower triangular parts of the Weibull and Stiffness matrices. The equations only take the main effects and the two-factor interaction terms, and this is why the input is in the form of a matrix. Since the matrix is symmetric, the program intends not to read in coefficients of the upper triangular region. The two title variable lines immediately following the WEIB(ULL) and STIF(FNESS) keywords are two comment lines, which make the input of coefficients more clear and easy (Note: the letters inside the parentheses of the two keywords are optional.). It should be noticed that the order of the title variables is fixed. The last two variables of Weibull equation can only be chosen either $\ln(n)$ or $\ln(\ln(n))$ at its input. It is

recommended that the two title variable lines should be input; otherwise, an empty line should replace it. The input order for the basic variables is very important and should be stringently observed. Although the coefficients of equations are handled with free format, it is recommended that user adapts the formatted input.

E.3 OUTPUT

The output consists of the fatigue damage process for each point as specified in the ELSYM5 input file; accordingly for any given instant you can find the damage pattern of said points within the asphalt concrete. The index of fatigue damage is represented by using the stiffness ratio. All the points specified in the ELSYM5 input file will be calculated and monitored. Thus the output file will consist of the history of stiffness ratios for all these points hour by hour. The correction factor that adjusts the effect caused by boundary conditions is listed in the first line. The following demonstrates the output format:

$$count \quad cum_reps \quad \overbrace{SR_1 \quad \cdots \quad SR_{10}}^{1^{st} \text{ Depth}} \quad \overbrace{SR_1 \quad \cdots \quad SR_{10}}^{2^{nd} \text{ Depth}} \quad \overbrace{SR_1 \quad \cdots \quad SR_{10}}^{3^{rd} \text{ Depth}} \quad \overbrace{SR_1 \quad \cdots \quad SR_{10}}^{\text{Bottom of AC layer}}$$

Again, the specific output format of this version of the *Weibull* program is specially tailored for WesTrack.

E.4 EXAMPLES

The following two examples demonstrate how to prepare the input, how to run the *Weibull* program, and what analysis is returned in the output file. The first example contains a fictitious traffic file that has all the traffic at 5L wander locations. The main purpose of this example is showing the obvious wander effect under this traffic pattern. The second example demonstrates the real simulation using the temperature and traffic data of WesTrack. These two

examples will share the same ELSYM5 file and equations file, that is to say, the same pavement structure and loading configuration and the same properties of asphalt mix will be applied on both examples. The ELSYM5 file and Equations file are listed below.

ELSYM5 input file:

```

PROBLEM 1 1
WesTrack
LOADS 2 5000. 100.
0. 0. 14.0 0.
XYOUT 10
8.0 0. 9.0 0. 10.0 0. 11.0 0. 12.0 0. 13.0 0. 14.0 0. 15.0 0.
17.0 0. 19.0 0.
ZOUT 4
1.0 3.0 5.0 5.99
NLAYERS 5
LAYER 1 1535902. 2.0 .35
LAYER 2 1654497. 2.0 .35
LAYER 3 32000. 2.0 .35
LAYER 4 20000. 12.0 .40
LAYER 5 3850. 0.0 .45
END

```

Weibull and Stiffness regression equations:

```

WEIBULL
const av ac vma temp rs4s50 m200 ln(stn) ln(n)
ln(ln(n))
31.1304 0.0 0.0 0.0 0.0 0.0 0.0 0.0 0.0 0.0
0.0 0.1027 0.0 0.0 0.0 0.0 0.0 0.0 0.0 0.0
0.0 0.0 0.0 0.0 0.0 0.0 0.0 0.0 0.0 0.0
0.0 0.0 0.0 0.0 0.0 0.0 0.0 0.0 0.0 0.0
0.0 0.0 0.0 0.0 -0.2448 0.0 0.0 0.0 0.0 0.0
0.0 0.0 0.0 0.0 0.0 -2.7272 0.0 0.0 0.0 0.0
0.0 0.0 0.0 0.0 0.0 0.0 -1.3976 0.0 0.0 0.0
0.0 0.0 0.0 0.0 -0.0355 0.0 0.0 2.8252 0.0 0.0
0.0 0.0 0.0 0.0 0.0 0.0 0.0 0.0 0.4935 0.0
0.0 0.0 0.0 0.0 0.0 0.0 0.0 0.0 0.0 0.0
STIFFNESS
const av ac vma temp
11.468 0.0 0.0 0.0 0.0
0.0 -0.0827 0.0 0.0 0.0
0.0 0.0 -0.2285 0.0 0.0
0.0 0.0 0.0 0.0 0.0
0.0 0.0 0.0 0.0 -0.058

```

Figure E.15 represents the corresponding pavement structure, the loading configuration of a dual-tire, coordinate setup, and the intended strain-calculation points. Notice that the origin of this coordinate system is under the center of the left tire.

E.4.1 Example Problem 1

The purpose of this example is to verify the wander effect by introducing an obvious traffic setup. The traffic file is prepared in such a way that all traffic is assumed to be applied at

the 5L wander location. The following lists the compute log of the *Weibull* program; the underlined words need to be specified by the user.

```
F:\temp>weibull
*** the environment and material file name: xenvmat.txt
*** the traffic file name: xreps.txt
*** the ELSYM5 input file name: elsym5.in
*** the Weibull and Stiffness equations input file name: eqn.dat
*** the output file name (wander): exl.out
*** the output file name (no wander): exlnw.out
*** correction factor (default=1.0)? 1.
```

The specific traffic file, *xreps.txt*, for example problem 1:

```
10000 0 0 0 0 0 0 0 0 0
20000 0 0 0 0 0 0 0 0 0
12000 0 0 0 0 0 0 0 0 0
10000 0 0 0 0 0 0 0 0 0
20000 0 0 0 0 0 0 0 0 0
12000 0 0 0 0 0 0 0 0 0
10000 0 0 0 0 0 0 0 0 0
20000 0 0 0 0 0 0 0 0 0
12000 0 0 0 0 0 0 0 0 0
10000 0 0 0 0 0 0 0 0 0
20000 0 0 0 0 0 0 0 0 0
12000 0 0 0 0 0 0 0 0 0
```

The environment and material file for example problem 1:

```
0
6.0 5.0 0.0 3.0 5.0
9.617893701 -0.009690748 102.5170364 172.4
9.360629921 -0.010340157 102.3094934 172.4
9.118070866 -0.013825 102.3094934 172.4
8.823543307 -0.012802953 102.3094934 172.4
8.590137795 -0.016741201 102.3094934 172.4
8.264694882 -0.018324154 102.3094934 172.4
7.967151575 -0.020566417 102.3094934 172.4
7.625283465 -0.02307437 102.3094934 172.4
7.286362205 -0.025141457 102.3094934 172.4
6.913775591 -0.02807874 102.3094934 172.4
6.43342126 -0.015802874 102.3094934 172.4
6.345281496 0.019932047 102.3094934 172.4
7.146889764 0.034477756 102.3094934 172.4
```

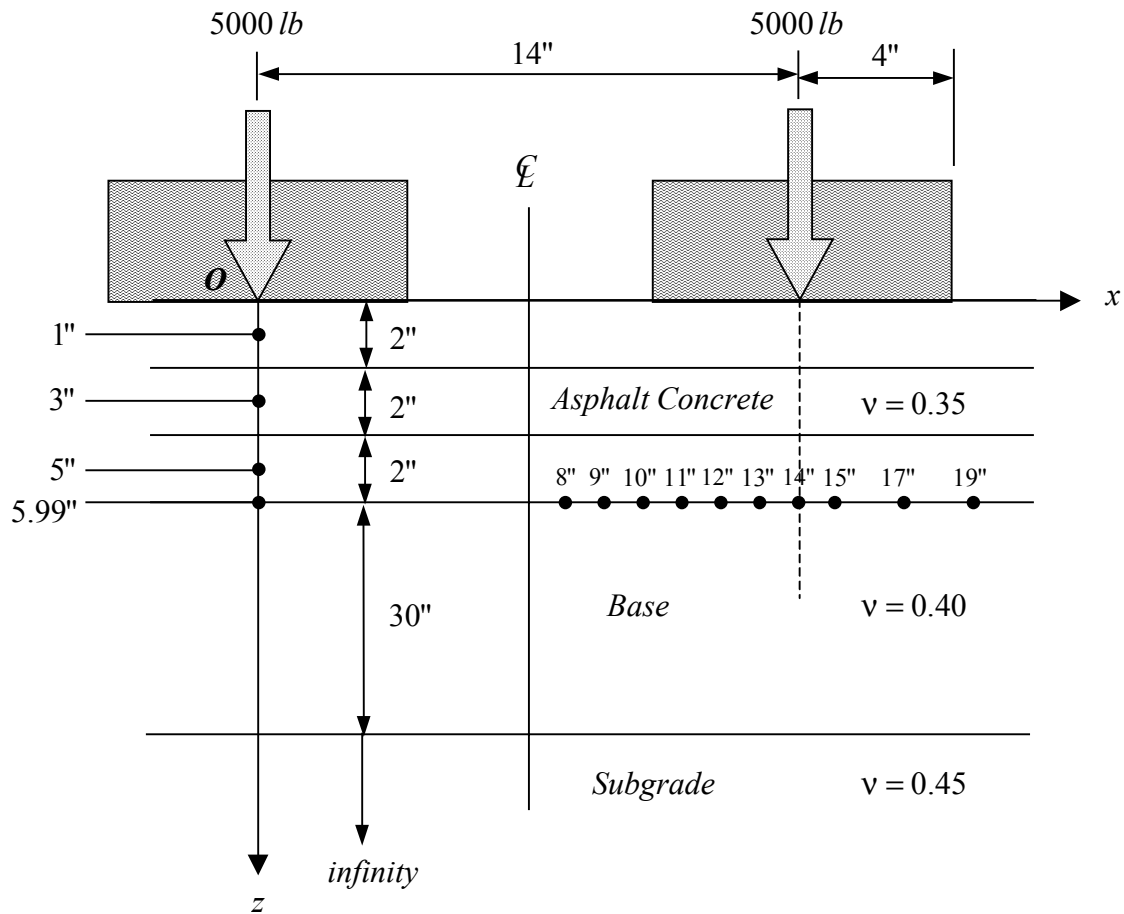

Figure E.15. Loading configuration, pavement structure, and ELSYM5 input of WesTrack for Weibull simulation.

The output is too tedious to show here. Instead, Figure E.16 and Figure E.17 present the image and contour plots of stiffness ratio after the last traffic loading for both wander and no wander cases respectively. Another information can be extracted from the output is shown in Figure E.18 which has two stiffness deterioration curves, wander and no wander, occurred at the bottom of the asphalt concrete layer and under the center of the right tire.

Example 1: wander case, AV=6.0

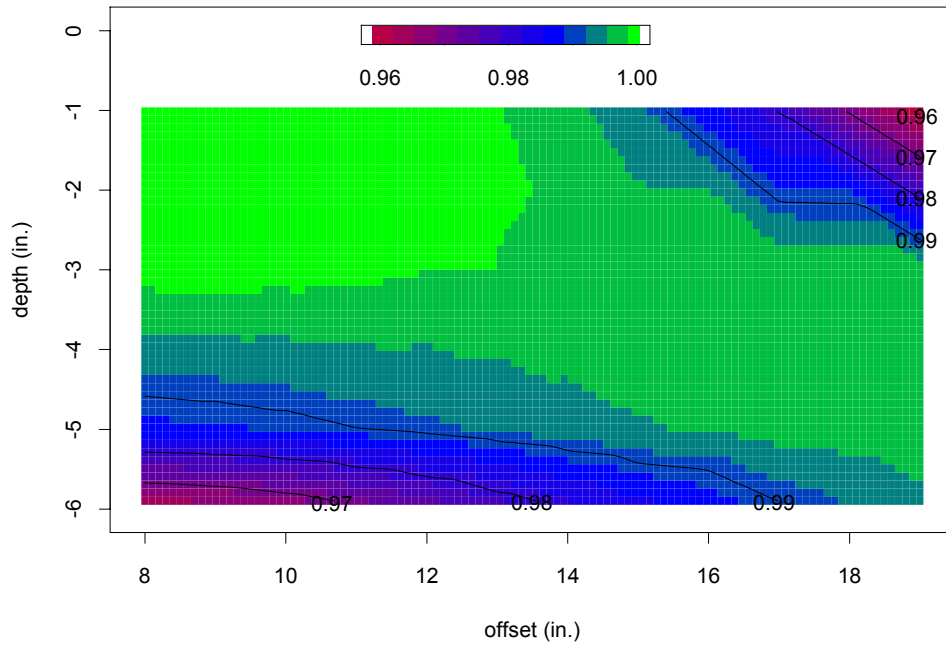

Figure E.16. Image-and-contour plot of stiffness ratio after the last application of traffic loading of example 1 with wander.

Example 1: no wander case, AV=6.0

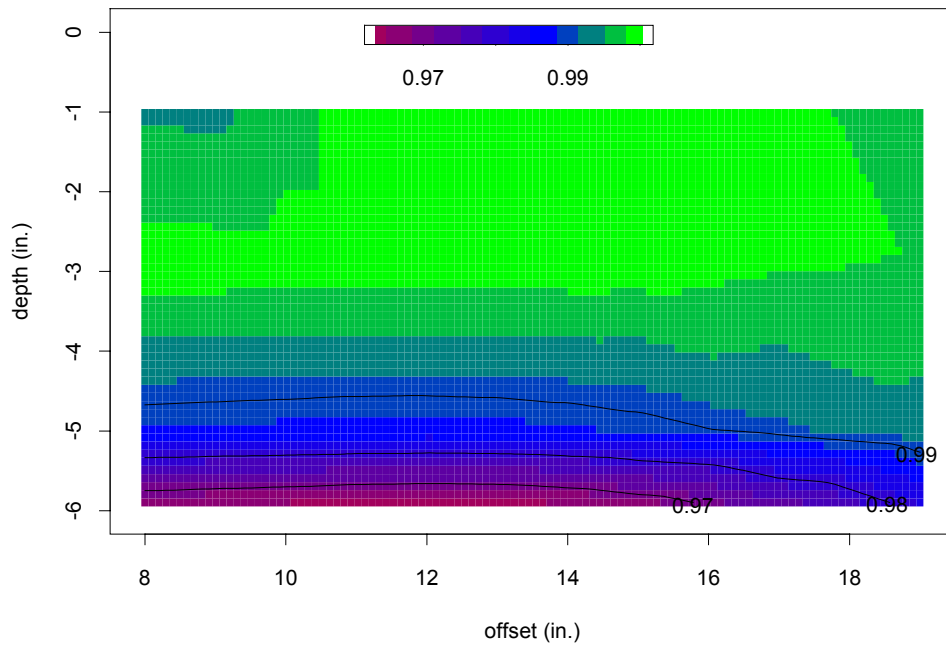
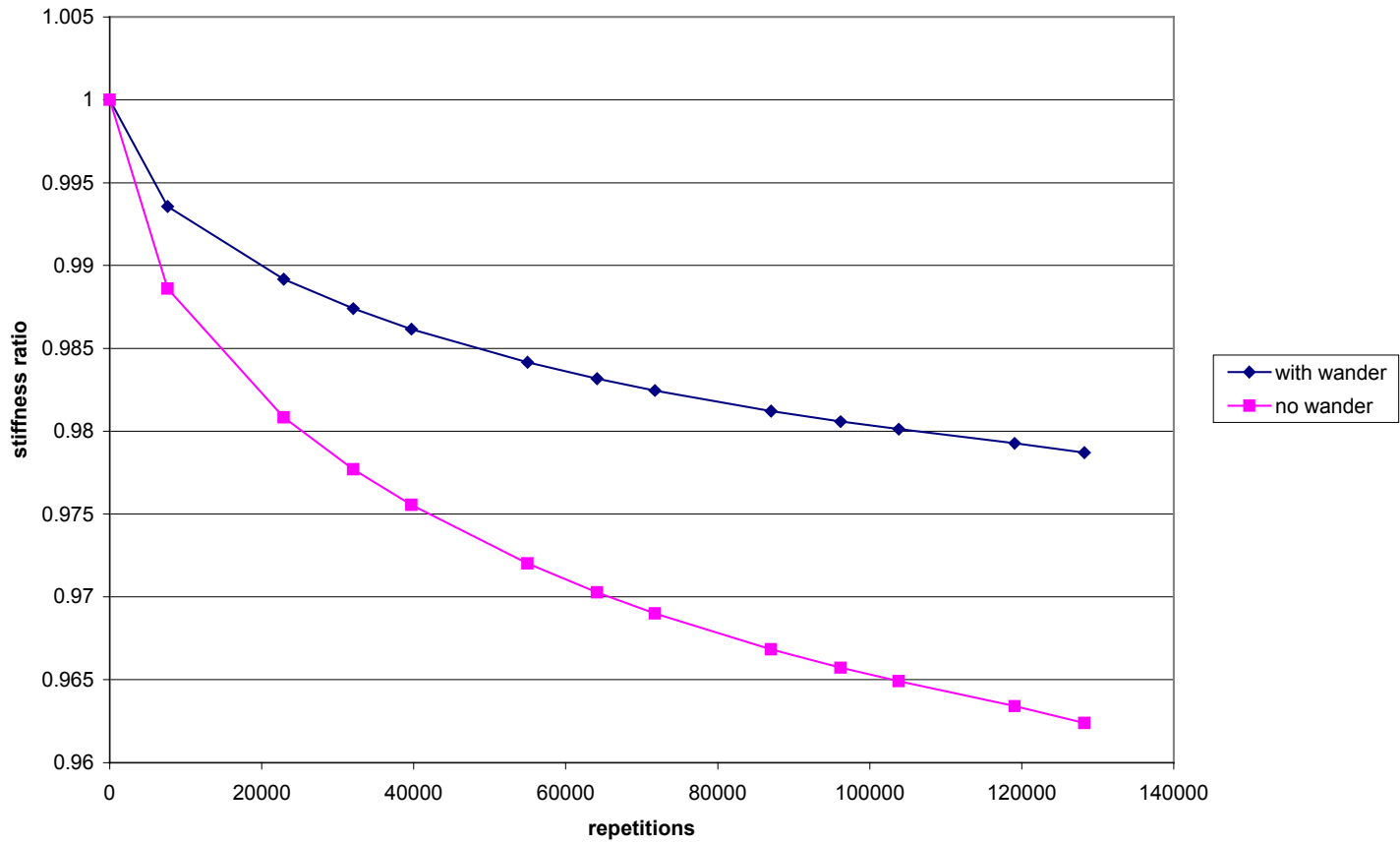

Figure E.17. Image-and-contour plot of stiffness ratio after the last application of traffic loading of example 1 with no wander.

Example of Problem 1



539

Figure E.18. Stiffness deterioration curves at offset 14 in. and depth 5.99 in. for both wander and no-wander cases for example 1.

E.4.2 Example Problem 2

In this example, the field data collected in WesTrack is incorporated as a demonstration of how the stiffness ratio of an asphalt concrete layer changes while subjected to variations in temperature and traffic pattern. Due to the enormous detail of the traffic file and the file of environment and material, it is not listed here. As in Example 1, the image and contour plots of the wander and no-wander cases are demonstrated separately in Figure E.19 and Figure E.20. The comparison of stiffness deterioration curves for the wander and no-wander cases at the same position of Example 1 is plotted in Figure E.21.

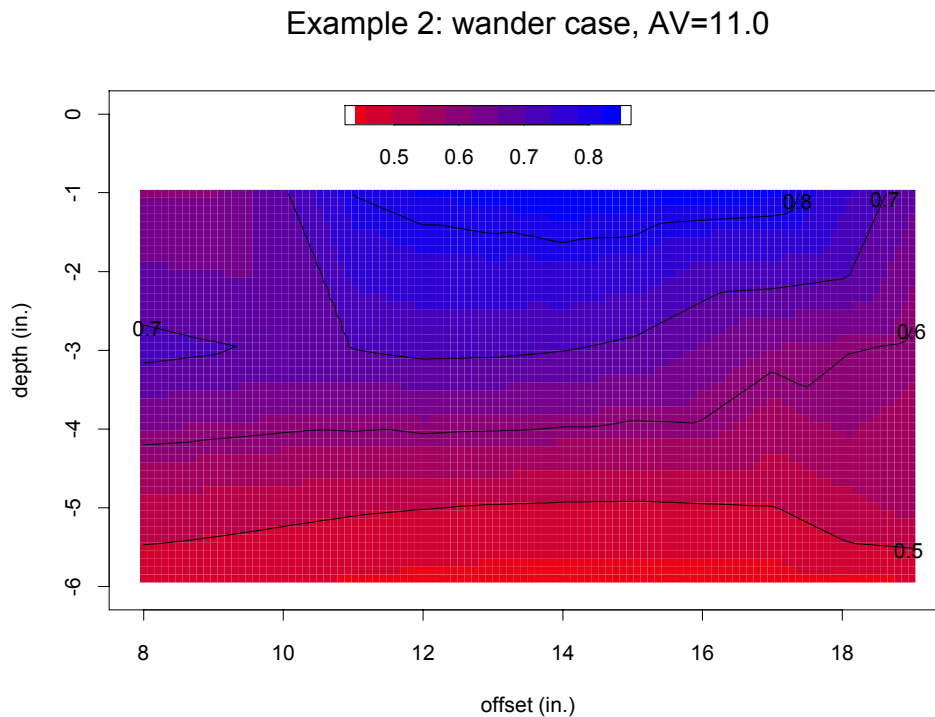

Figure E.19. Image-and-contour plot of stiffness ratio after the last application of traffic loading of WesTrack (example 2: with wander).

Example 2: no wander case, AV=11.0

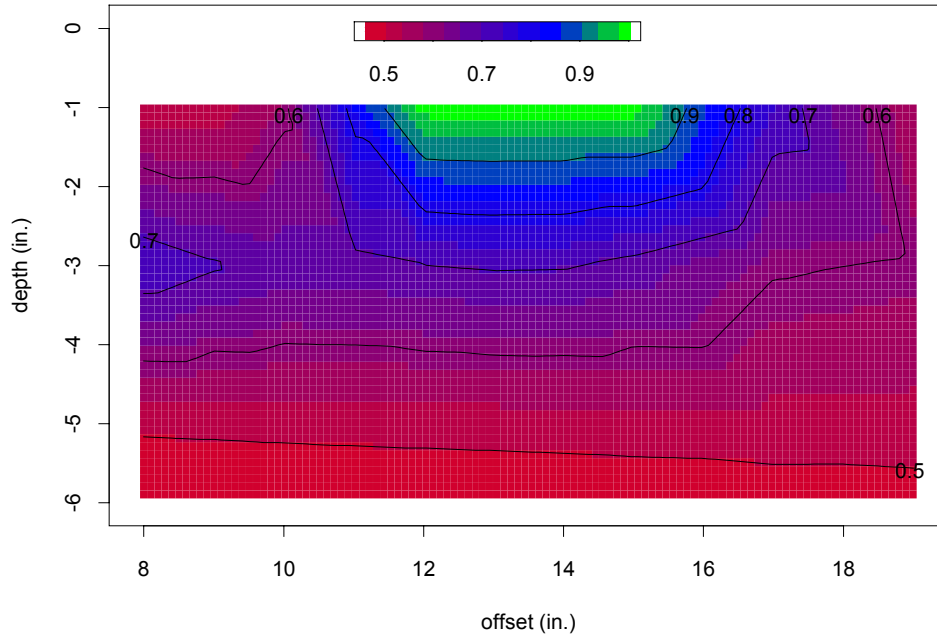
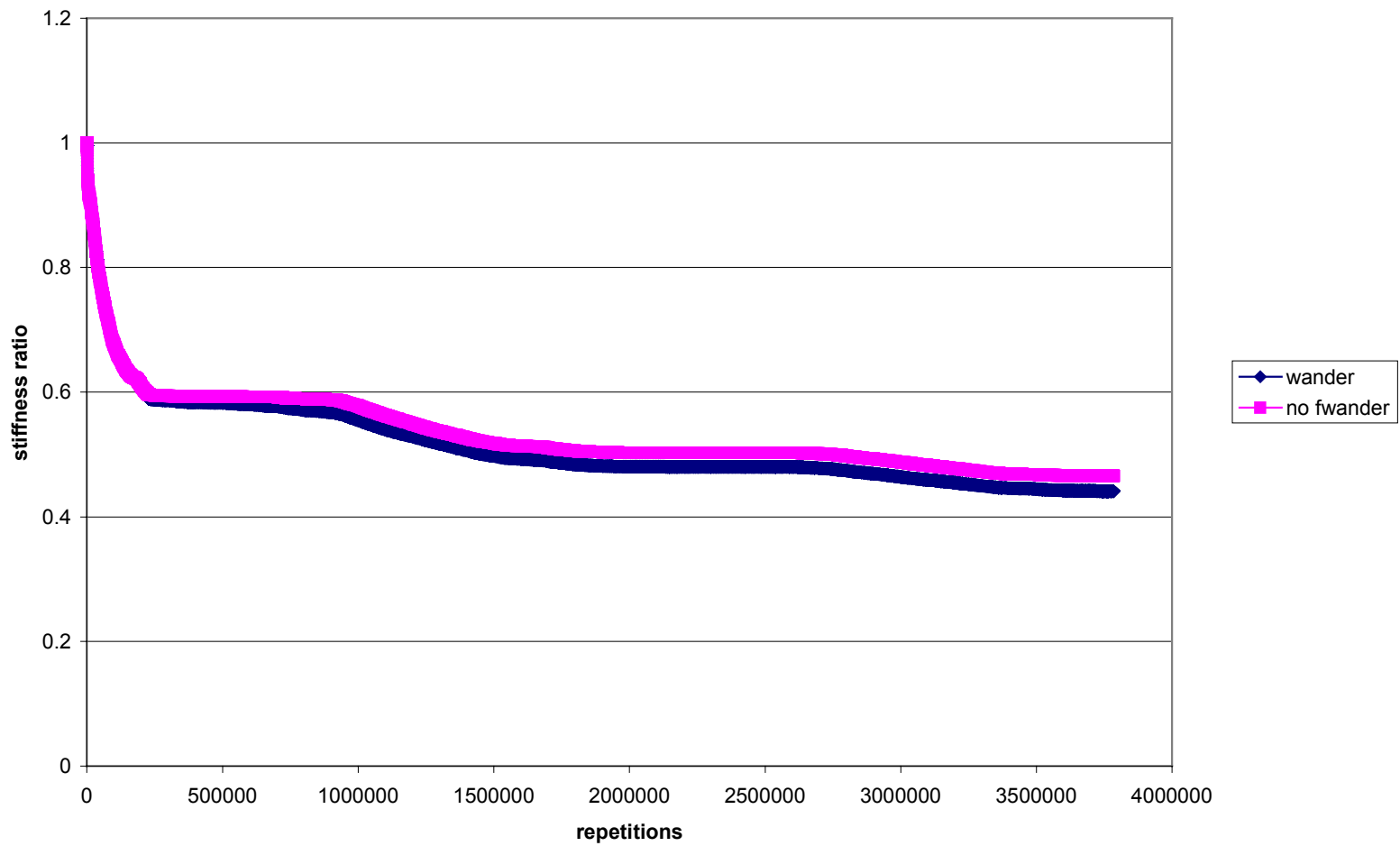

Figure E.20. Image-and-contour plot of stiffness ratio after the last application of traffic loading of WesTrack (example 2: with no wander).

Example of Problem 2



S42

Figure E.21. Stiffness deterioration curves for example 2.

E.5 SOURCE CODE

E.5.1 Main Program: Weibull_Simulation

```
!=====
program Weibull_simulation

use equations
! contains Weibull and Stiffness regression equations

use Strain_Engine
! includes modules: ELSYM5_Program + array_manipulations

use ELSYM5_File_Modify
! change the ELSYM5 input file based on new stiffness values

implicit none

type SrPoint
  real(8)::sr
  real::x,z
end type SrPoint

!-----+
!
! envmat_file: contains Tb,G,sg,base,(av),(ac),(vma)
! traffic_file: contains traffic and wander information
! elsym5_file: contains the information of pavement structure and
!             loading
! equation_file: contains the information of stiffness and Weibull
!             equations
!-----+

character(30)::envmat_file,traffic_file,elsym5_file,equation_file
integer::envmat_file_unit=1,traffic_file_unit=2,elsym5_file_unit=3,&
equation_file_unit=4
integer::envmat_status,traffic_status,elsym5_status,equation_status
integer::input_envmat_status,input_traffic_status

!-----+
!
! temp_file is working as a temporary elsym5 input file
!-----+

character(30)::temp_file
integer::temp_file_unit=11
integer::temp_status

!-----+
!
! result_file should output the SRs (stiffness ratio), time, and
! cumulated repetitions (wander)
! result_nw_file is for no wander.
!-----+

character(30)::result_file,result_nw_file
integer::result_file_unit=21,result_nw_file_unit=22
integer::result_status,result_nw_status

!-----+
!
```

```

! Temporary file for check
!
!-----+
!character(30)::xxx_file="xxx.tmp"
!integer::xxx_file_unit=30
!integer::xxx_file_status
!-----+
!
! Define the global constants
!
!-----+

real,parameter::offset_unit=1.0 ! unit:inch
! The wander_pos will be set as an odd number, for the symmetricity
! of loading configuration.
integer,parameter::WTTYPE=11
real,parameter::psi_to_Pa=6.894757e3
real,parameter::esal_to_reps=0.76336
real,parameter::inch_to_mm=25.4

!-----+
!
! define the global variables
!
!-----+

character(1)::is_av ! is_av is the first row in EnvMat file
real::tb,g,sg,base,av,ac,vma,rs4s50,m200
real,dimension(-5:5)::traffic_temp
integer,dimension(-5:5)::traffic
integer::i,j
real::phi
! note: WBLNUM and STIFNUM are defined in module equations
real,dimension(WBLNUM,WBLNUM)::coef_wbl
real,dimension(STIFNUM,STIFNUM)::coef_stif
real::center
integer::nxy,nz
integer::n0
real,dimension(10)::zout
integer::index
integer::cum_reps
type(SrPoint),dimension(:),allocatable::sr_old,sr_old_nowander,sr_new,&
sr_new_nowander
real(8),dimension(:),allocatable::sr_old_avg,sr_new_avg,sr_old_nw_avg,&
sr_new_nw_avg
integer::AllocateStatus

!*****
!
!-----+
!
! open the EnvMat file
!
!-----+

write (*,'(lx,a)',advance="no") " *** the environment and material file name: "
read *,envmat_file
open(unit=envmat_file_unit,file=envmat_file,status="old",&
action="read",access="sequential",iostat=envmat_status)
if(envmat_status>0) stop " *** input error: envmat_file *** "

!-----+
!
! open the traffic file
!
!-----+

write (*,'(lx,a)',advance="no") " *** the traffic file name: "

```

```

read *,traffic_file
open(unit=traffic_file_unit,file=traffic_file,status="old",&
      action="read",access="sequential",iostat=traffic_status)
if(traffic_status>0) stop "*** input error: traffic_file ***"

!-----+
!
! open the ELSYM5 file
!
!-----+

write (*,'(lx,a)',advance="no") "*** the ELSYM5 input file name: "
read *,elsym5_file
open(unit=elsym5_file_unit,file=elsym5_file,status="old",&
      action="read",access="sequential",iostat=elsym5_status)
if(elsym5_status>0) stop "*** input error: elsym5_file ***"

!-----+
!
! open the equations file
!
!-----+

write (*,'(lx,a)',advance="no") "*** the Weibull and Stiffness&
                                equations input file name: "
read *,equation_file
open(unit=equation_file_unit,file=equation_file,status="old",&
      action="read",access="sequential",iostat=equation_status)
if(equation_status>0) stop "*** input error: equation_file ***"

!-----+
!
! open the result file
!
!-----+

write (*,'(lx,a)',advance="no") "*** the output file name (wander): "
read *,result_file
open(unit=result_file_unit,file=result_file,status="new",&
      action="write",iostat=result_status)
if(result_status>0) stop "*** output error: result_file ***"

write (*,'(lx,a)',advance="no") "*** the output file name (no wander): "
read *,result_nw_file
open(unit=result_nw_file_unit,file=result_nw_file,status="new",&
      action="write",iostat=result_nw_status)
if(result_nw_status>0) stop "*** output error: result_nw_file ***"

!-----+
!
! open the xxx.tmp file
!
!-----+

!open(unit=xxx_file_unit,file=xxx_file,status="new",&
      action="write",iostat=xxx_file_status)
!if(xxx_file_status>0) stop "*** output error: xxx_file ***"

!-----+
!
! Enter the correction factor caused by the boundary condition
! difference
!
!-----+

write(*,'(lx,a)',advance="no") "*** correction factor (default=1.0)? "
read *, phi ! refer to the accelerated failure time model

!-----+
!
! Enter the location that intends for being monitored for the fatigue

```

```

! damage process.
!
!-----+
!write(*,'(lx,a)') "**** Note: the following input must be consistant &
!               with the ELSYM5 input file."
!write(*,'(lx,a)',advance="no") "**** location of fatigue damage process? "
!read *, xpos
! must be consistant with the ELSYM5 input file

!-----+
!
! read in the coefficients of equations
!
!-----+

call read_in_equations(equation_file_unit,equation_file,coef_wbl,coef_stif)

!-----+
!
! open the ELSYM5 file to fetch ZOUT, center of loads application
!
!-----+

call go_through_ELSYM5(elsym5_file_unit,elsym5_file,center,nxy,nz,zout)

!-----+
!
! Initialization of sr_old, sr_old_nowander, sr_new, and
! sr_new_nowander arrays.
!
!-----+

allocate(sr_old(nxy*nz),sr_new(nxy*nz),sr_old_nowander(nxy*nz),&
         sr_new_nowander(nxy*nz),sr_old_avg(nz),sr_new_avg(nz),&
         sr_old_nw_avg(nz),sr_new_nw_avg(nz), stat=AllocateStatus)
if(AllocateStatus /=0) stop "**** Not enough memory! ****"

do i=1,nz
  sr_old_avg(i)=1.0
  sr_new_avg(i)=1.0
  sr_old_nw_avg(i)=1.0
  sr_new_nw_avg(i)=1.0
  do j=1,nxy
    sr_old(j+(i-1)*nxy)%sr=1.0
    sr_new(j+(i-1)*nxy)%sr=1.0
    sr_old_nowander(j+(i-1)*nxy)%sr=1.0
    sr_new_nowander(j+(i-1)*nxy)%sr=1.0
  end do
end do

!-----+
!
! Check the AV input of envmat_file.
!
!-----+

read(envmat_file_unit,'(a1)') is_av
if (is_av=="1") then
  read(envmat_file_unit,*) ac,vma,rs4s50,m200
else
  read(envmat_file_unit,*) av,ac,vma,rs4s50,m200
end if

index=0
n0=0

write(result_file_unit,'(lx,a,f6.3//)') "correction factor= ",phi
write(result_nw_file_unit,'(lx,a,f6.3//)') "correction factor= ",phi

do !***** Main do loop *****

```

```

!write(30,*) "***** count= ",count !!!!!
if (is_av=="1") then
  read(envmat_file_unit,*,iostat=input_envmat_status) tb,g,sg,base,av
else
  read(envmat_file_unit,*,iostat=input_envmat_status) tb,g,sg,base
end if

if (input_envmat_status>0) stop "*** input error ***"
if (input_envmat_status<0) exit ! end of file

read(traffic_file_unit,*,iostat=input_traffic_status) (traffic_temp(i),i=-5,5)
if (input_traffic_status>0) stop "*** input error ***"
if (input_traffic_status<0) exit ! end of file

do i=-5,5
  traffic(i)=traffic_temp(i)*esal_to_reps
end do

call process_one_hour(elsym5_file_unit,elsym5_file,center,nz,zout, &
  tb,g,sg,base,av,ac,vma,rs4s50,m200,&
  coef_wbl,coef_stif,n0,traffic, &
  cum_reps,phi,sr_old,sr_new,&
  sr_old_nowander,sr_new_nowander,&
  sr_old_avg,sr_new_avg,&
  sr_old_nw_avg,sr_new_nw_avg)

index=index+1
n0=cum_reps
do i=1,nz
  sr_old_avg(i)=sr_new_avg(i)
  sr_old_nw_avg(i)=sr_new_nw_avg(i)
  do j=1,nxy
    sr_old(j+(i-1)*nxy)%sr=sr_new(j+(i-1)*nxy)%sr
    sr_old_nowander(j+(i-1)*nxy)%sr=sr_new_nowander(j+(i-1)*nxy)%sr
  end do
end do
print *, "***** count = ",index

write(result_file_unit,'(1x,2i10,40f12.8)') index,cum_reps,&
  (sr_new(i)%sr,i=1,40)
write(result_nw_file_unit,'(1x,2i10,40f12.8)') index,cum_reps,&
  (sr_new_nowander(i)%sr,i=1,40)

! if(sr_new(nz)%sr<0. .or. sr_new_nowander(nz)%sr<0.0 .or. sr_new_mstn(i)<0.0) then
!   exit
! end if
do i=1,nxy
  if (sr_new(i+(nz-1)*nxy)%sr<0. .or. sr_new_nowander(i+(nz-1)*nxy)%sr<0.) then
    exit
  end if
end do

end do !***** end Main do loop *****

deallocate(sr_new,sr_old,sr_old_nowander,sr_new_nowander)
deallocate(sr_old_avg,sr_new_avg,sr_old_nw_avg,&
  sr_new_nw_avg)

close(envmat_file_unit)
close(traffic_file_unit)
close(elsym5_file_unit)
close(result_file_unit)
close(result_nw_file_unit)
close(temp_file_unit)

```

contains

!-----

```

subroutine process_one_hour(infile_unit,infile,center,nz,nout, &
                           tb,g,sg,base,av,ac,vma,rs4s50,m200,&
                           coef_wbl,coef_stif,n0,traffic, &
                           cum_reps,phi,sr_old,sr_new,&
                           sr_old_nowander,sr_new_nowander,&
                           sr_old_avg,sr_new_avg,&
                           sr_old_nw_avg,sr_new_nw_avg)

implicit none

integer,intent(in)::infile_unit
character(30),intent(in)::infile
real,intent(in)::center,tb,g,sg,base,av,ac,vma,rs4s50,m200
integer,intent(in)::nz
integer,intent(inout)::n0
real,dimension(nz),intent(in)::nout ! desired depths
integer,dimension(-5:5),intent(in)::traffic
real,dimension(WBLNUM,WBLNUM),intent(in)::coef_wbl
real,dimension(STIFNUM,STIFNUM),intent(in)::coef_stif
integer,intent(out)::cum_reps
real,intent(in)::phi
type(SrPoint),dimension(nxy*nz),intent(inout)::sr_old
type(SrPoint),dimension(nxy*nz),intent(out)::sr_new
real(8),dimension(nz),intent(inout)::sr_old_avg
real(8),dimension(nz),intent(out)::sr_new_avg
type(SrPoint),dimension(nxy*nz),intent(inout)::sr_old_nowander
type(SrPoint),dimension(nxy*nz),intent(out)::sr_new_nowander
real(8),dimension(nz),intent(inout)::sr_old_nw_avg
real(8),dimension(nz),intent(out)::sr_new_nw_avg

integer::i,j,k
real,dimension(nz)::temp
real,dimension(nz)::s0
integer::sum
integer::cum_reps_nowander

sum=0
do i=1,nz
  temp(i)=tb+g*(nout(nz)-nout(i))*inch_to_mm
  call stiffness_function(coef_stif,av,ac,vma,temp(i),s0(i))
  s0(i)=s0(i)*1e6/psi_to_Pa
  print *, "++++ so(i)=",s0(i)," temp(i)= ",temp(i)
end do

do i=-5,5
  sum=sum+traffic(i)
end do

if (sum==0) then
  do i=1,nz
    sr_new_avg(i)=sr_old_avg(i)
    sr_new_nw_avg(i)=sr_old_nw_avg(i)
    do j=1,nxy
      sr_new(j+(i-1)*nxy)%sr=sr_old(j+(i-1)*nxy)%sr
      sr_new_nowander(j+(i-1)*nxy)%sr=sr_old_nowander(j+(i-1)*nxy)%sr
    end do
  end do
  cum_reps=n0
else
  do i=-5,5
    print *, "*****8"
    if (traffic(i) .NE. 0) then
      print *, "### i*offset",i*offset_unit

      call process_one_node(infile_unit,infile,center,i*offset_unit,&
                           sg,base,av,ac,vma,temp,rs4s50,m200,s0, &
                           nxy,nz,n0,traffic(i),coef_wbl,cum_reps,phi,&
                           sr_old,sr_new,sr_old_avg,sr_new_avg,&
                           sr_old_nowander,sr_new_nowander,&
                           sr_old_nw_avg,sr_new_nw_avg)
    end if
  end do
end if

```

```

do j=1,nz
  sr_old_avg(j)=sr_new_avg(j)
  sr_old_nw_avg(j)=sr_new_nw_avg(j)
  do k=1,nxy
    sr_old(k+(j-1)*nxy)%sr=sr_new(k+(j-1)*nxy)%sr
    sr_old_nowander(k+(j-1)*nxy)%sr=sr_new_nowander(k+(j-1)*nxy)%sr
  end do
end do
n0=cum_reps
end do

end if

end subroutine process_one_hour
!-----

!-----
subroutine process_one_node(infile_unit,infile,center,wander,      &
                           sg,base,av,ac,vma,temp,rs4s50,m200,s0,  &
                           nxy,nz,n0,dn,coef_wbl,cum_reps,phi,&
                           sr_old,sr_new,sr_old_avg,sr_new_avg,&
                           sr_old_nowander,sr_new_nowander,&
                           sr_old_nw_avg,sr_new_nw_avg)

implicit none
integer::infile_unit
character(30)::infile
real,intent(in)::center,wander
real,intent(in)::sg,base,av,ac,vma,rs4s50,m200
integer,intent(in)::nxy,nz
real,dimension(nz),intent(in)::s0,temp
integer,intent(in)::n0,dn
real,dimension(WBLNUM,WBLNUM),intent(in)::coef_wbl
integer,intent(out)::cum_reps
real,intent(in)::phi ! correction factor for boundary condition
type(SrPoint),dimension(nxy*nz),intent(in)::sr_old
type(SrPoint),dimension(nxy*nz),intent(out)::sr_new
real(8),dimension(nz),intent(in)::sr_old_avg
real(8),dimension(nz),intent(out)::sr_new_avg
type(SrPoint),dimension(nxy*nz),intent(in)::sr_old_nowander
type(SrPoint),dimension(nxy*nz),intent(out)::sr_new_nowander
real(8),dimension(nz),intent(in)::sr_old_nw_avg
real(8),dimension(nz),intent(out)::sr_new_nw_avg

integer::outfile_unit=20
character(30)::outfile="elsym5.tmp"
type(point),dimension(max_z*max_xy)::stn      ! tensile strains at time t
type(point),dimension(max_z*max_xy)::stn_nw ! tensile strains - no wander
real,dimension(5)::layer_stiffness,layer_stiffness_nw
integer::i,j
real,dimension(nz)::avgstn,avgstn_nw
type(SrPoint),dimension(nxy*nz)::dsr,dsr_nw
real(8),dimension(nz)::avg_dsr,avg_nw_dsr
integer::nnz

do i=1,nz
  layer_stiffness(i)=s0(i)*sr_old_avg(i)
  layer_stiffness_nw(i)=s0(i)*sr_old_nw_avg(i)
end do

layer_stiffness(nz)=base*1e6/psi_to_Pa
layer_stiffness_nw(nz)=layer_stiffness(nz)
layer_stiffness(5)=sg*1e6/psi_to_Pa
layer_stiffness_nw(5)=layer_stiffness(5)

do i=1,nz

```

```

    print *, "**** stif= ", layer_stiffness(i), "**** stif_nw= ", &
        layer_stiffness_nw(i)
end do

call change_ELSYM5_input(infile_unit, infile, outfile_unit, outfile, layer_stiffness)
call strain_calculation(outfile_unit, outfile, center, wander, nnz, stn, avgstn)

call change_ELSYM5_input(infile_unit, infile, outfile_unit, outfile, layer_stiffness_nw)
call strain_calculation(outfile_unit, outfile, center, 0., nnz, stn_nw, avgstn_nw)

print *, "*****avgstn*****"
print *, avgstn
print *, "*****avgstn_nw*****"
print *, avgstn_nw

do i=1, nxy*nnz

    sr_new(i)%x=stn(i)%x
    sr_new_nowander(i)%x=stn_nw(i)%x
    dsr(i)%x=stn(i)%x
    dsr_nw(i)%x=stn_nw(i)%x

    sr_new(i)%z=stn(i)%z
    sr_new_nowander(i)%z=stn_nw(i)%z
    dsr(i)%z=stn(i)%z
    dsr_nw(i)%z=stn_nw(i)%z

    sr_new(i)%sr=0.0
    sr_new_nowander(i)%sr=0.0
    dsr(i)%sr=0.0
    dsr_nw(i)%sr=0.0

end do

do i=1, nnz

    if (avgstn(i)<=0.) then
        avgstn(i)=1e-10
    end if

    if (avgstn_nw(i)<=0.) then
        avgstn_nw(i)=1e-10
    end if

    call weibull_function(coef_wbl, n0, av, ac, vma, temp(i), rs4s50, m200, avgstn(i), &
        dn, phi, avg_dsr(i))

    call weibull_function(coef_wbl, n0, av, ac, vma, temp(i), rs4s50, m200, avgstn_nw(i), &
        dn, phi, avg_nw_dsr(i))

    do j=1, nxy

        if (stn(j+(i-1)*nxy)%stn<=0.) then
            stn(j+(i-1)*nxy)%stn=1e-10
        end if
        call weibull_function(coef_wbl, n0, av, ac, vma, temp(i), rs4s50, m200, &
            stn(j+(i-1)*nxy)%stn, dn, phi, dsr(j+(i-1)*nxy)%sr)

        if (stn_nw(j+(i-1)*nxy)%stn<=0.) then
            stn_nw(j+(i-1)*nxy)%stn=1e-10
        end if
        call weibull_function(coef_wbl, n0, av, ac, vma, temp(i), rs4s50, m200, &
            stn_nw(j+(i-1)*nxy)%stn, dn, phi, dsr_nw(j+(i-1)*nxy)%sr)

        sr_new(j+(i-1)*nxy)%sr=sr_old(j+(i-1)*nxy)%sr+dsr(j+(i-1)*nxy)%sr
        sr_new_nowander(j+(i-1)*nxy)%sr=sr_old_nowander(j+(i-1)*nxy)%sr+
            dsr_nw(j+(i-1)*nxy)%sr

    end do
end do

```



```
    sr_new_avg(i)=sr_old_avg(i)+avg_dsr(i)
    sr_new_nw_avg(i)=sr_old_nw_avg(i)+avg_nw_dsr(i)

end do

cum_reps=n0+dn

close(outfile_unit,status="delete")

end subroutine process_one_node
!-----

end program Weibull_simulation
!=====
```

E.5.2 Module Strain_Engine

```
module Strain_Engine

use ELSYM5_Program
use Link_List

type point
  real::x,z,stn
end type point

integer,parameter::total_rows=100,pe_col=6,max_depth_no=10,&
  max_xy=10,max_z=4

contains

!-----
subroutine strain_calculation(infile_unit,infile,center,wander,nnz,&
  stn,avgstn)
  implicit none

  integer,intent(in)::infile_unit
  character(30),intent(in)::infile
  real,intent(in)::center
  real,intent(in)::wander
  integer,intent(out)::nnz
  type(point),dimension(max_z*max_xy),intent(out)::stn
  real,dimension(max_depth_no),intent(out)::avgstn

  integer::nnxy
  real,dimension(total_rows,pe_col)::pe_array

  integer::i,j

  type(point),dimension(:),allocatable::temp_array,new_array,&
    double_array

  ! initiate stn array
  do i=1,max_z*max_xy
    stn(i)%x=0.0
    stn(i)%z=0.0
    stn(i)%stn=0.0
  end do

  call tensile_strain(infile_unit,infile,nnz,nnxy,pe_array)

  allocate(new_array(nnxy*nnz),temp_array(nnxy),&
    double_array(2*nnxy))

  call reduce_matrix(nnz,nnxy,pe_array,new_array)
  stn=new_array

  do i=1,nnz
    temp_array=new_array((nnxy*(i-1)+1):nnxy*i)
    call mirror_array(center,nnxy,temp_array,double_array)
    do j=1,nnxy
      call find_array_strain(2*nnxy,double_array,temp_array(j)%x-wander,&
        stn(j+(i-1)*nnxy)%stn)
    end do
  end do

  call find_array_avgstn(nnz,nnxy,stn,avgstn)

  deallocate(new_array,temp_array,double_array)

end subroutine strain_calculation
!-----
```

```

!-----
subroutine make_image(center,old_x,old_stn,new_x,new_stn,d)

  implicit none

  real,intent(in)::center,old_x,old_stn
  real,intent(out)::new_x,new_stn,d

  d=old_x-center
  new_x=center-d
  new_stn=old_stn

end subroutine make_image
!-----

!-----
subroutine mirror_array(center,n,old_array,new_array)

  implicit none

  real,intent(in)::center
  integer,intent(in)::n
  type(point),dimension(n),intent(in)::old_array
  type(point),dimension(2*n),intent(out)::new_array

  integer::i
  real::d,new_x,new_y
  type(pointListPtr),pointer::head,temp
  integer::AllocateStatus

  nullify(head) ! reset the head

  call InsertBack(head,old_array(1)%x,old_array(1)%stn)
  call make_image(center,old_array(1)%x,old_array(1)%stn,new_x,new_y,d)

  if (d<0) then
    call InsertBack(head,new_x,new_y)
  else
    allocate(temp,stat=AllocateStatus)
    if (AllocateStatus /=0) stop "**** Not enough memory ****"
    temp%point%x=new_x
    temp%point%y=new_y
    temp%next=>head
    head=>temp
  end if

  do i=2,n
    call make_image(center,old_array(i)%x,old_array(i)%stn,new_x,new_y,d)
    call InsertSort(head,old_array(i)%x,old_array(i)%stn)
    call InsertSort(head,new_x,new_y)
  end do

  temp=>head
  do i=1,2*n
    new_array(i)%x=temp%point%x
    new_array(i)%stn=temp%point%y
    new_array(i)%z=old_array(1)%z
    temp=>temp%next
  end do

end subroutine mirror_array
!-----

!-----
function interpolation(point1,point2,xpos)

```

```

implicit none

real::interpolation
type(point),intent(in)::point1,point2
real,intent(in)::xpos

real::ratio

ratio=(point2%stn-point1%stn)/(point2%x-point1%x)
interpolation=point1%stn+(xpos-point1%x)*ratio

end function interpolation
!-----

!-----
subroutine reduce_matrix(nnz,nnxy,pe_array,new_array)

implicit none

integer,intent(in)::nnz,nnxy
real,dimension(total_rows,pe_col),intent(in)::pe_array
type(point),dimension(nnxy*nnz),intent(out)::new_array

real,dimension(nnxy*nnz)::max_array
integer::i,j

max_array=maxval(pe_array(1:nnxy*nnz,4:6),2)

do i=1,nnz
  do j=1,nnxy
    new_array(j+nnxy*(i-1))%x=pe_array(j+nnxy*(i-1),1)
    new_array(j+nnxy*(i-1))%z=pe_array(j+nnxy*(i-1),3)
    new_array(j+nnxy*(i-1))%stn=max_array(j+nnxy*(i-1))
  end do
end do

end subroutine reduce_matrix
!-----

!-----
subroutine find_array_strain(n,list,x,stn)

implicit none

integer,intent(in)::n
type(point),dimension(n),intent(in)::list
real,intent(in)::x
real,intent(out)::stn

integer::i,pos

i=1
do while (i<n)
  if (x <= list(1)%x) then
    pos=1
    exit
  else
    if (x > list(n)%x) then
      pos=n-1
      exit
    else
      if (x>list(i)%x .and. x<=list(i+1)%x) then
        pos=i
        exit
      else
        i=i+1
      end if
    end if
  end if
end do while

```

```

        end if
    end if
end do

stn=interpolation(list(pos),list(pos+1),x)

end subroutine find_array_strain
!-----

!-----
subroutine find_array_maxpos(n,list,maxpos)

implicit none

integer,intent(in)::n
type(point),dimension(n),intent(in)::list
real,intent(out)::maxpos

integer::i,pos=1

do i=1,n
    if (list(i)%stn>=list(pos)%stn) then
        pos=i
    end if
end do

maxpos=list(pos)%x

end subroutine find_array_maxpos
!-----

!-----
subroutine find_array_avgstn(nz,nxy,list,avgstn)

implicit none

integer,intent(in)::nz,nxy
type(point),dimension(nz*nxy),intent(in)::list
real,dimension(nz),intent(out)::avgstn

integer::i,j
real::sum

do i=1,nz
    sum=0.
    do j=1,nxy
        sum=sum+list(j+(i-1)*nxy)%stn
    end do
    avgstn(i)=sum/nxy
end do

end subroutine find_array_avgstn
!-----

end module Strain_Engine

```

E.5.3 Module: Equations

```

module equations

! ### important ###=====
!

```

```

! number of covariates of the Weibull regression equation = 10
! i.e. CONST,AV,AC,VMA,TEMP,RS4S50,M200,LN(STN),LN(N),LN(LN(N))
!
! number of covariates of the initial stiffness equation = 5
! i.e. CONST,AV,AC,VMA,TEMP
!
!=====

integer, parameter::WBLNUM=10,STIFNUM=5

contains

!-----
subroutine read_in_equations(infile_unit,infile,wbl,stif)
!
! read in the coefficients of a Weibull regression equation
!
! for example, an equation:
!
!  $\ln(-\ln(SR))=c0+c1*AV+c2*AC+c3*TEMP+c4*\ln(STN)+c5*\ln(N)$ 
!  $+c6*RS4S50+c7*TEMP*\ln(STN)$ 
!
! where, SR = stiffness ratio,
! AV = % air-void content,
! AC = % asphalt content,
! TEMP = temperature in Celsius,
! STN = tensile microstrain,
! N = cumulated repetitions,
! RS4S50 = ratio of percent passing #4 and #50 sieves, and
! ln = natural logarithm.
!
! and,
!
! read in the coefficients of a Stiffness regression equation
!
! for example, an equation for stiffness of asphalt concrete:
!
!  $\ln(STIF)=c0+c1*AV+c2*AC+c3*TEMP$ 
!
! where, STIF = stiffness (MPa)
! AV = % air-void content
! AC = % asphalt content
! TEMP = temperature in Celsius
!-----

implicit none

integer,intent(in)::infile_unit
character(30),intent(in)::infile
real,dimension(WBLNUM,WBLNUM),intent(out)::wbl
real,dimension(STIFNUM,STIFNUM),intent(out)::stif

integer::open_status_in,input_status
character(4)::key
integer::i,j
character(100)::dummy

open(unit=infile_unit,file=infile,status="old",action="read",&
access="sequential",position="rewind",iostat=open_status_in)
if(open_status_in>0) stop "**** cannot open input file ****"

do
read(infile_unit,'(a4)',iostat=input_status) key
if (input_status>0) stop "**** input error ****"
if (input_status<0) exit
if (key .EQ. 'WEIB') then
read(infile_unit,'(1x,a)') dummy
do i=1,WBLNUM
read(infile_unit,*) (wbl(i,j),j=1,WBLNUM)

```

```

        end do
    else if (key .EQ. 'STIF') then
        read(infile_unit,'(1x,a)') dummy
        do i=1,STIFNUM
            read(infile_unit,*) (stif(i,j),j=1,STIFNUM)
        end do
    end if
end do

end subroutine read_in_equations
!-----

!-----
subroutine weibull_function(coef_wbl,n0,av,ac,vma,temp,rs4s50,m200,stn,delta_n,phi,dsr)
!
! find the difference of SR before and after applying n ESALs
! at a specified condition
!
! coef_wbl: coefficient matrix of the weibull regression equation
! n0: the cumulative ESALs after previous condition
! n: the newly applied traffic
! dsr: the SR difference after applying n repetitions
!
! The default format of weibull regression function is as follows:
!
!  $\ln(-\ln(SR)) = \ln(\text{Lambda}) + AV + AC + VMA + TEMP + RS4S50 + M200 + \ln(STN) + \ln(N)$  (or  $\ln(\ln(N))$ )
!           +two-term interaction
!
! where  $\ln(\text{Lambda}) = \text{const}$ 
!
!-----

implicit none
real,dimension(WBLNUM,WBLNUM),intent(in)::coef_wbl
real,intent(in)::av,ac,vma,temp,rs4s50,m200,stn
integer,intent(in)::n0,delta_n
real,intent(in)::phi
! the correction factor based on the Weibull Accelerated Failure Time Model
real(8),intent(out)::dsr

real::gamma,sum
real(8)::sr0,sr1

call sum_table(coef_wbl,n0,av,ac,vma,temp,rs4s50,m200,stn,sum,gamma)
sr0=exp(-exp(sum-gamma*log(phi)))
call sum_table(coef_wbl,n0+delta_n,av,ac,vma,temp,rs4s50,m200,stn,sum,gamma)
sr1=exp(-exp(sum-gamma*log(phi)))

dsr=sr1-sr0

if (dsr>0) then
    dsr=0
end if

end subroutine weibull_function
!-----

!-----
subroutine sum_table(coef_wbl,n,av,ac,vma,temp,rs4s50,m200,stn,sum,gamma)

implicit none

real,dimension(WBLNUM,WBLNUM), intent(in)::coef_wbl
real,intent(in)::av,ac,vma,temp,rs4s50,m200,stn
integer,intent(in)::n
real,intent(out)::sum

```

```

real,intent(out)::gamma

real,dimension(WBLNUM,WBLNUM)::table
real,dimension(WBLNUM)::var
integer::i,j

do i=1,WBLNUM
  do j=1,WBLNUM
    table(i,j)=0.0
  end do
end do

if (coef_wbl(10,10)==0.) then
  if (n==0) then
    var(9)=log(1e-10)
  else
    var(9)=log(real(n))
  end if
  gamma=coef_wbl(9,9)
  var(10)=0.0
else
  if (coef_wbl(9,9)==0.) then
    if (n==0) then
      var(10)=log(log(1.000001))
    else
      var(10)=log(log(real(n)))
    end if
    gamma=coef_wbl(10,10)
    var(9)=0.0
  end if
end if

var(1)=1.0
var(2)=av
var(3)=ac
var(4)=vma
var(5)=temp
var(6)=rs4s50
var(7)=m200
var(8)=log(stn)

sum=0.0

do j=1,WBLNUM
  do i=j,WBLNUM
    if (i==j) then
      table(i,j)=var(i)
    else
      table(i,j)=var(i)*var(j)
    end if
    sum=sum+coef_wbl(i,j)*table(i,j)
  end do
end do

end subroutine sum_table
!-----

!-----
subroutine stiffness_function(coef_stif,av,ac,vma,temp,stif)
!
! The default stiffness equation is defined as follows:
!
! ln(stif)=c0+c1*AV+c2*AC+c3*VMA+c4*TEMP
!
! find the first derivative of the Weibull regression equation
! at a specific condition
!
!-----

```



```

implicit none

real,dimension(STIFNUM,STIFNUM)::coef_stif
real,intent(in)::av,ac,vma,temp
real,intent(out)::stif

real,dimension(STIFNUM)::var
real,dimension(STIFNUM,STIFNUM)::table
real::sum
integer::i,j

do i=1,STIFNUM
  do j=1,STIFNUM
    table(i,j)=0.
  end do
end do

sum=0.
var(1)=1.0
var(2)=av
var(3)=ac
var(4)=vma
var(5)=temp

do j=1,STIFNUM
  do i=j,STIFNUM
    if (i==j) then
      table(i,j)=var(i)
    else
      table(i,j)=var(i)*var(j)
    end if
    sum=sum+table(i,j)*coef_stif(i,j)
  end do
end do

stif=exp(sum)

end subroutine stiffness_function
!-----

end module equations

```

E.5.4 Module: ELSYM5_File_Modify

```
module ELSYM5_File_Modify
contains
!-----
subroutine change_ELSYM5_input(infile_unit,infile,outfile_unit,outfile,stif)

  implicit none

  character(30),intent(in)::infile
  integer,intent(in)::infile_unit
  character(30),intent(in)::outfile
  integer,intent(in)::outfile_unit
  real,dimension(5),intent(in)::stif

  integer::open_status_in,open_status_out,input_status
  integer::i,ival,izsw
  character(80)::rest_line
  character(4)::NDIR,NRST
  real,dimension(5)::val1,val2,val3
  character(2)::fropt
  character,dimension(2)::temp

  open(unit=infile_unit,file=infile,status="old",action="read",&
    access="sequential",position="rewind",iostat=open_status_in)
  if(open_status_in>0) stop "*** cannot open input file ***"

  open(unit=outfile_unit,file=outfile,status="unknown",action="write",&
    access="sequential",iostat=open_status_out)
  if(open_status_out>0) stop "*** cannot open the output file ***"

  do
    read(infile_unit,'(a4,a76)',iostat=input_status) &
      NDIR,rest_line
    if(input_status>0) stop "*** input error ***"
    if(input_status<0) exit

    select case (NDIR)

      case ('NLAY') ! case for 'NLAY'

        write(outfile_unit,'(a4,a76)') NDIR,rest_line
        NRST=rest_line(1:4)
        temp(1)=rest_line(5:5)
        temp(2)=rest_line(6:6)
        call convert_char_to_number(temp,ival)
        do i=1,ival
          read(infile_unit,'(2a4,i2,f10.0,2f5.0,a2,2x,i1)') &
            NDIR,NRST,ival,val1(i),val2(i),val3(i),fropt,izsw
          if(izsw .EQ. 0) then
            write(outfile_unit,'(2a4,i2,f10.0,f5.1,f5.2,a2,2x)') &
              NDIR,NRST,ival,stif(i),val2(i),val3(i),fropt
          else
            write(outfile_unit,'(2a4,i2,f10.0,f5.1,f5.2,a2,2x,i1)') &
              NDIR,NRST,ival,stif(i),val2(i),val3(i),fropt,izsw
          end if
        end do

      case ('END ') ! case for 'END '
        write(outfile_unit,'(a4)') NDIR

      case default
        write(outfile_unit,'(a4,a76)') NDIR,rest_line
    end select
  end do
end subroutine
```

```

        end select

    end do
    close(infile_unit)
    close(outfile_unit)

end subroutine change_ELSYM5_input
!-----
!
!
!
!-----
subroutine go_through_ELSYM5(infile_unit,infile,center,nxy,nz,zout)

    implicit none
    integer,intent(in)::infile_unit
    character(30),intent(in)::infile
    real,intent(out)::center
    integer,intent(out)::nxy,nz
    real,dimension(10),intent(out)::zout

    integer::open_status,input_status
    character(4)::NDIR
    character(76)::rest_line
    integer::ival,nload
    character,dimension(2)::temp
    real::a,b,c,d
    integer::i

    open(unit=infile_unit,file=infile,status="old",position="rewind",&
        action="read",access="sequential",iostat=open_status)
    if(open_status>0) stop "*** input error: elsym5_file ***"

    do
        read(infile_unit,'(a4,a76)',iostat=input_status) NDIR,rest_line
        if(input_status>0) stop "*** input error ***"
        if(input_status<0) exit
        temp(1)=rest_line(5:5)
        temp(2)=rest_line(6:6)
        call convert_char_to_number(temp,ival)

    select case (NDIR)

        case ('LOAD')
            nload=ival
            read(infile_unit,'(4f5.2)') a,b,c,d
            center=(c-a)/2.0

        case ('XYOU')
            nxy=ival

        case ('ZOUT')
            nz=ival
            read(infile_unit,'(10f5.2)') (zout(i),i=1,10)

    end select

    end do

end subroutine go_through_ELSYM5
!-----
!
!
!
!-----
subroutine convert_char_to_number(string,number)

    implicit none
    character,dimension(2),intent(in)::string
    integer,intent(out)::number

```

```

integer,dimension(2)::digit
integer::i

do i=1,2
  select case (string(i))
    case ( ' ')
      digit(i)=0
    case ('0')
      digit(i)=0
    case ('1')
      digit(i)=1
    case ('2')
      digit(i)=2
    case ('3')
      digit(i)=3
    case ('4')
      digit(i)=4
    case ('5')
      digit(i)=5
    case ('6')
      digit(i)=6
    case ('7')
      digit(i)=7
    case ('8')
      digit(i)=8
    case ('9')
      digit(i)=9
  end select
end do

number=digit(1)*10+digit(2)

end subroutine convert_char_to_number
!-----

end module ELSYM5_File_Modify

```

E.5.5 Module: Link_List

```
module Link_List

  implicit none

  type PointList
    real::x,y
  end type PointList

  type PointListPtr
    type(PointList)::point
    type(PointListPtr),pointer::next
  end type PointListPtr

contains

!-----
subroutine DelList(list)
  type(PointListPtr),pointer::list,temp

  do
    if (associated(list)) then
      temp=>list
      list=>list%next
      nullify(temp%next)
      deallocate(temp)
    else
      exit
    end if
  end do

end subroutine DelList
!-----
!
!
!
!-----
subroutine InsertFront(head,a,b)
  type(PointListPtr),pointer::head,temp
  integer::AllocateStatus
  real::a,b

  nullify(head)
  allocate(temp,stat=AllocateStatus)
  if (AllocateStatus /=0) stop "*** Not enough memory ***"
  temp%point%x=a
  temp%point%y=b
  temp%next=>head
  head=>temp

end subroutine InsertFront
!-----
!
!
!
!-----
subroutine InsertBack(head,a,b)
  type(PointListPtr),pointer::head,temp
  real::a,b

  if (.NOT.associated(head)) then
    call InsertFront(head,a,b)
  else
    temp=>head
    do while(associated(temp%next))
      temp=>temp%next
    end do
  end if
end subroutine InsertBack
```

```

        call InsertFront(temp%next,a,b)
    end if

end subroutine InsertBack
!-----
!
!
!
!-----
subroutine InsertBetween(head,PredPtr,CurrPtr,temp)
    type(PointListPtr),pointer::head,PredPtr,CurrPtr,temp

    temp%next=>CurrPtr
    PredPtr%next=>temp

end subroutine InsertBetween
!-----
!
!
!
!-----
subroutine InsertSort(head,a,b)
! pre: the head linked list has at least two elements
! con: put the new element (a,b) in order of linked list
    type(PointListPtr),pointer::head,temp,PredPtr,CurrPtr,tail
    real,intent(in)::a,b
    integer::AllocateStatus

    PredPtr=>head
    CurrPtr=>head%next
    tail=>head

    do while(associated(tail%next))
        tail=>tail%next
    end do

    allocate(temp,stat=AllocateStatus)
    if (AllocateStatus /=0) stop "Not enough memory"
    temp%point%x=a
    temp%point%y=b
    nullify(temp%next)

    do while(associated(CurrPtr))
        if (a<=head%point%x) then
            temp%next=>head
            head=>temp
            exit
        else
            if (a>tail%point%x) then
                tail%next=>temp
                exit
            else
                if (a<=CurrPtr%point%x .and. a>PredPtr%point%x) then
                    temp%next=>CurrPtr
                    PredPtr%next=>temp
                    exit
                else
                    PredPtr=>PredPtr%next
                    CurrPtr=>CurrPtr%next
                end if
            end if
        end if
    end do

end subroutine InsertSort
!-----
!
!
!
!-----
subroutine WriteList(head)

```

```
type(PointListPtr),pointer::head,temp

temp=>head
do while(associated(temp))
  print *,temp%point%x,temp%point%y
  temp=>temp%next
end do

end subroutine WriteList
!-----
!
!
!-----

end module Link_List
```

E.5.6 Module: ELSYM5_Program

Module ELSYM5_Program

contains

```
      subroutine tensile_strain(infile_unit,infile,nnz,nnxy,pe_array)
C     ELSARE.FOR
C
C     ELSYM5 CONVERTED FOR USE IN SSS FORTRAN ON VICTOR 9000
C     CONVERTED BY ARE INC
C           2600 DELLANA LANE
C           AUSTIN, TX 78746
C
C     DATE          APRIL 1985
C
C     PROGRAM ELDRIV (INPUT,OUTPUT,TAPE5=INPUT,TAPE6=OUTPUT)
CCC
C     ELDRIV - DRIVER PROGRAM (INPUT/OUTPUT PLUS INPUT GUIDE) FOR THE
C     ELSYM5 SUBROUTINE PACKAGE DEVELOPED BY A.E. +ELSYM5 PREVIOUSLY
C     WAS A COMPLETE PROGRAM WRITTEN BY GALE AHLBORN, UNIVERSITY OF
C     CALIFORNIA (ITTE) AT BERKELEY.  BASED ON CHEVRON LAYER PROGRAM.
C
C     RUSSELL CATALANO - NOV 1978
C     PETER JORDAHL JUNE 1979 ADDS TO INPUT GUIDE
C
C
C           I N P U T   G U I D E
C
C     INSTRUCTIONS TO THE PROGRAM ARE SUPPLIED IN THE FORM OF DIRECTIVE
C     THE FIRST EIGHT CHARACTERS OF A DIRECTIVE CONTAIN A KEYWORD
C     IDENTIFYING THE TYPE OF INFORMATION BEING ENTERED. ALL KEYWORDS
C     MAY BE ABBREVIATED TO THEIR FIRST FOUR CHARACTERS.
C
C     MORE THAN ONE PROBLEM MAY BE SOLVED IN A SINGLE EXECUTION OF THE
C     PROGRAM. EACH PROBLEM IS PREFACED WITH A "PROBLEM" DIRECTIVE AND
C     THE LAST PROBLEM OF A RUN IS TERMINATED BY AN "END " DIRECTIVE. ALL
C     RELEVANT INFORMATION MUST BE SUPPLIED FOR THE FIRST PROBLEM VIA THE
C     VARIOUS DIRECTIVES DESCRIBED BELOW. SUBSEQUENT PROBLEMS IN THE SAME
C     RUN NEED ONLY SPECIFY DIRECTIVES WHICH ARE TO BE CHANGED. ALL OTHER
C     VALUES WILL BE RETAINED FROM THE PRECEDING PROBLEM. HOWEVER, ALL
C     DATA ON A SINGLE DIRECTIVE MUST BE SUPPLIED, EVEN IF ONLY ONE VALUE
C     IS BEING CHANGED.
C
C     ALL DIRECTIVES SHARE A COMMON FORMAT, BUT THE MEANINGS OF THE
C     FIELDS DIFFER DEPENDING ON THE KEYWORD IDENTIFIER. THESE SPECIFIC
C     MEANINGS ARE DESCRIBED BELOW UNDER THE HEADINGS OF THE APPROPRIATE
C     KEYWORDS. THE GENERAL FORMAT IS AS FOLLOWS:
C
C     FIELD      COLUMN      TYPE OF      FORMAT
C     NAME       NUMBERS     VALUE        USED
C     -----
C     KEYWORD    1-8         CHARACTER    2A4
C     IVAL       9-10        INTEGER      I2
C     VAL(1)     11-20       REAL         F10.0
C     VAL(2)     21-25       REAL         F5.0
C     VAL(3)     26-30       REAL         F5.0
C
C     FROPT      31-32       CHARACTER    A2
C     IZSW       35          INTEGER      I1
C
C     FROPT (FRICTION OPTION) IS USED ONLY ON THE -LAYER- DIRECTIVE
C     FOR THE DEEPEST LAYER, AND ONLY WHEN A RIGID BASE IS DESIRED.
C     IZSW IS USED ONLY ON THE -ZOUT- DIRECTIVE.
C
C     SOME DIRECTIVES REQUIRE FURTHER VALUES FROM CARDS WHICH ARE
C     PLACED IMMEDIATELY AFTER THE CARD ON WHICH THE DIRECTIVE APPEARS.
```



```

C
C NOTE: ZVAL = -1 SIGNIFIES THE BOTTOM OF LAYER LNUM.
C       ZVAL = X SIGNIFIES X INCHES BELOW THE TOP OF LAYER LNUM.
C       FOR LAYER 1, ZVAL = 0 SIGNIFIES OUTPUT AT DEPTH = 0.
C       PUNCHED IN F5.2 FORMAT STARTING IN COLUMNS 11-15.
C       DEFAULTS ARE 0.
C
C       THE NUMBER OF ZVAL VALUES MUST BE EQUAL TO JZ FOR ANY GIVEN L
C
C REMEMBER:
C IN ORDER TO SIGNAL THAT THE SECOND METHOD IS TO BE USED, A 1 IS PUNC
C IN COLUMN 35 OF THE ZOUT DIRECTIVE. ANYTHING OTHER THAN 1 IN COLUMN
C INDICATES THE FIRST METHOD IS TO BE USED.
C
C-----
C-----
C
!=====
! declaration of the output tensile strain array
!
!
!       use C_ELCTL
!       use C_ELSYS
!       use C_ELCOM
!       use C_CONST
!       use C_RDIN
!
!       integer,intent(in)::infile_unit
!       character(30),intent(in)::infile
!       integer,intent(out)::nnz,nnxy
!       integer,parameter::total_rows=100,pe_col=6
!       real,dimension(total_rows,pe_col),intent(out)::pe_array
!       character(30)::FILEIN
!
!
!=====
CHARACTER*1 Y,P,D,LYN
CHARACTER*3 FOORN
CHARACTER*24 LAB1(9)
CHARACTER*5 LAB2(3,9)
CHARACTER*4 NDRSVE,IEND,NDIR
integer:: OpenStatusIn,CloseStatus
C
COMMON /ELCTL/ KSW1, KSW2,KSW3, KSW4, NBZ, NEI, NEX, NGQP,
!
.      NI, NLSW, NTEST, NTSI, NX, WRL
!
COMMON /ELSYS/ NEL, E(5), V(5), TH(5), CI, DI(5)
!
COMMON /ELCOM/ FOR, PRES, RL, NLD, XL(10),YL(10), NXY, NZ
!
.      , XP(10),YP(10),Z(10),LAYZ(10)
!
.      , SNRM(3,10,10), SSHR(3,10,10), PS(3,10,10)
!
.      , PSS(3,10,10), DISP(3,10,10), ENRM(3,10,10)
!
.      , ESHR(3,10,10), PE(3,10,10), PSE(3,10,10)
!
COMMON /CONST/ ICD,IPR,DUM(19)
!
COMMON /RDIN/ YYYY,IVAL,NSY,LCNT,VAL(3),TITLE(20),IVLSVE,SVVAL1,
!
1 XXXXXX
DATA Y,P,D /'Y','P','D'/
DATA LAB1 / 'NORMAL STRESSES      \,
2          'SHEAR STRESSES        \,
3          'PRINCIPAL STRESSES    \,
4          'PRINCIPAL SHEAR STRESSES',
5          'DISPLACEMENTS        \,
6          'NORMAL STRAINS        \,
7          'SHEAR STRAINS         \,
8          'PRINCIPAL STRAINS     \,
9          'PRINCIPAL SHEAR STRAINS \/'
DATA LAB2 / 'SXX  \,'SYX  \,'SZZ  \,
2          'SXY  \,'SXZ  \,'SYZ  \,
3          'PS 1 \,'PS 2 \,'PS 3 \,
4          'PSS 1','PSS 2','PSS 3',
5          'UX   \,'UY   \,'UZ   \,
6          'EXX  \,'EYY  \,'EZZ  \,
7          'EXY  \,'EXZ  \,'EYZ  \,

```

```

8          'PE 1 ', 'PE 2 ', 'PE 3 ',
9          'PSE 1', 'PSE 2', 'PSE 3' /

DATA IEND/ 'END ' /
NBZ = 46
NGQP = 4
ICD = infile_unit
FILEIN=infile

open(unit=ICD,file=FILEIN,status="OLD",position="REWIND",
*      action="READ",access="SEQUENTIAL",iostat=OpenStatusIn)

if(OpenStatusIn>0) stop "*** cannot open the ELSYM5 input file."

! IPR=10
! 18 open(unit=IPR,file=FLEOUT,status="NEW",action="WRITE",
!      *      iostat=OpenStatusOut)
!      if(OpenStatusOut>0) stop "*** cannot open output file ***"

READ (ICD,100) NDIR,NSY,VAL(1)
100 FORMAT (A4,4X,I2,F10.0)
3 CALL READIN (NDIR,NDRSVE,IEND)
C
C CALL ELSYM5 WITH ALL REQUIRED INPUT DATA FOR SOLUTIONS
C
CALL ELSYM5
C
PRINT SOLUTIONS
C
! allocate(pe_array(1:nz*nxy,1:pe_col),stat=allocate_status)
! if (allocate_status /=0) stop "*** not enough memory ***"
nnz=NZ
nxy=NXY

DO 1327 NZC = 1,NZ
DO 1327 L = 1,NXY
NXX = 0

pe_array(L+NXY*(NZC-1),1)=xp(L)
pe_array(L+NXY*(NZC-1),2)=yp(L)
pe_array(L+NXY*(NZC-1),3)=z(NZC)
pe_array(L+NXY*(NZC-1),4)=pe(1,L,NZC)
pe_array(L+NXY*(NZC-1),5)=pe(2,L,NZC)
pe_array(L+NXY*(NZC-1),6)=pe(3,L,NZC)

! write(*,1325) (pe_array(L,jjj),jjj=1,pe_col)
! 1325 format(1H ,3F6.2,1x,3(2x,E10.3))
1327 CONTINUE

IF (NDRSVE .EQ. IEND) GO TO 50
NSY = NSY+1
IVAL = IVLSVE
VAL(1) = SVVAL1
NDIR = NDRSVE
IF (IVLSVE .NE. 0) NSY = IVLSVE
GO TO 3

!
50 continue

! close(unit=IPR)

close(unit=ICD,iostat=CloseStatus)
if (CloseStatus>0) then
write(*,1236)
end if

!
1236 FORMAT (1X,'TROUBLE CLOSING ICD')
! STOP

```

END subroutine tensile_strain

```
C*****
SUBROUTINE READIN (NDIR,NDRSVE,IEND)
C
  use C_ELSYS
  use C_ELCOM
  use C_RDIN
  use C_DEPTH
  use C_CONST

  CHARACTER*4 NDIR,NDRSVE,IEND
  CHARACTER*3 KEY8,NDIR3
  CHARACTER*4 KEY(7),IPROB
  integer:: CloseStatus

C
!   COMMON /ELSYS/ NEL, E(5), V(5), TH(5), CI, DI(5)
!   COMMON /ELCOM/ FOR, PRES, RL, NLD, XL(10),YL(10), NXY, NZ
!   .           ,   XP(10),YP(10),Z(10),LAYZ(10)
!   .           ,   SNRM(3,10,10), SSHR(3,10,10),   PS(3,10,10)
!   .           ,   PSS(3,10,10), DISP(3,10,10), ENRM(3,10,10)
!   .           ,   ESHR(3,10,10),   PE(3,10,10),   PSE(3,10,10)
!   COMMON /RDIN/  YYYYY,IVAL,NSY,LCNT,VAL(3),TITLE(20),IVLSVE,SVVAL1,
!   1 XXXXXX
!   COMMON /DEPTH/ THK(6), JZ(5), ZVAL(5,5), IWARN, IZ, LNUM(5)
!   COMMON /CONST/ ICD,IPR,DUM(19)
  DATA KEY /'LAYE','PROB','NLAY','LOAD','XYOU','ZOUT','END '/
  DATA IPROB /'PROB'/
  NSY = 0
  LCNT = 0
  LDIR = 0
  JZOUT = 0
  3 IF (NDIR .EQ. IPROB) GO TO 5
  WRITE (IPR,105)
105 FORMAT (1H1//5X,'PROBLEM CARD MISSING FOR FIRST PROBLEM SET,'/5X,
  1 'OPERATIONS TERMINATED')
  GO TO 50
  5 CONTINUE
  IF (VAL(1) .EQ. 0.0) GO TO 9

C
C   INPUT TITLE CARD
C
  READ (ICD,107) TITLE
107 FORMAT (20A4)

C
C   INPUT REMAINDER OF DIRECTIVES FOR THIS PROBLEM
C
  9 CONTINUE
  READ (ICD,110) NDIR,IVAL,(VAL(I),I=1,3),FROPT,IZSW
110 FORMAT (A4,4X,I2,F10.0,2F5.0,A2,2X,I1)

C
C   SEARCH KEY TABLE FOR NDIR
C
  I = 1
  10 CONTINUE
  IF (NDIR .EQ. KEY(I)) GO TO (60,65,70,75,80,85,65), I
  READ (NDIR,1010) NDIR3
1010 FORMAT (A3)
  IF (NDIR3.EQ.KEY8) GO TO 65
  I = I+1
  IF (I .GT. 7) GO TO 40
  GO TO 10

C
C   INPUT LAYER DIRECTIVE
C
  60 IF (IVAL .LE. 0 .OR. IVAL .GT. NEL) CALL ELSYM5
  LCNT = LCNT+1
  LDIR = 1
  E(IVAL) = VAL(1)
  TH(IVAL) = VAL(2)
```

```

V(IVAL) = VAL(3)
IF (IVAL .EQ. NEL) CI = FROPT
GO TO 9
C
C INPUT PROBLEM DIRECTIVE
C
65 IVLSVE = IVAL
SVVAL1 = VAL(1)
NDRSVE = NDIR
IF ((LDIR.EQ.1).AND.(IZOUT.EQ.1).AND.(JZOUT.EQ.0))
*CALL DEPTHS(NDIR,NDRSVE)
GO TO 170
C
C INPUT NUMBER OF LAYERS DIRECTIVE
C
70 NEL = IVAL
IF (NEL .LE. 0 .OR. NEL .GT. 5) CALL ELSYM5
GO TO 9
C
C INPUT LOADS DIRECTIVE
C
75 NLD = IVAL
IF (NLD .LE. 0 .OR. NLD .GT. 10) CALL ELSYM5
FOR = VAL(1)
PRES = VAL(2)
READ (ICD,120) (XL(I),YL(I),I=1,NLD)
120 FORMAT (16(F5.2))
GO TO 9
C
C INPUT NUMBER OF X-Y LOCATIONS WHERE RESULTS ARE DESIRED
C
80 NXY = IVAL
IF (NXY .LE. 0 .OR. NXY .GT. 10) CALL ELSYM5
READ (ICD,120) (XP(I),YP(I),I=1,NXY)
GO TO 9
C
C INPUT DEPTHS WHERE RESULTS ARE DESIRED
C
85 IF (IZSW .EQ. 1) GO TO 180
IZOUT = 0
JZOUT = 1
NZ = IVAL
IF (NZ .LE. 0 .OR. NZ .GT. 10) CALL ELSYM5
READ (ICD,120) (Z(I),I=1,NZ)
GO TO 9
180 IZ = IVAL
IZOUT = 1
JZOUT = 1
IWARN = 0
DO 181 I=1,IZ
READ (ICD,125) LNUM(I), JZ(I), (ZVAL(I,J),J=1,5)
125 FORMAT (2I4,2X,5F5.2)
181 CONTINUE
CALL DEPTHS (NDIR,NDRSVE)
GO TO 9
C
C PRINT THE INPUT DATA
C
!
170 continue
! 170 WRITE (IPR,122) NSY
! WRITE (IPR,124) TITLE
! WRITE (IPR,126) NEL,NLD,NXY,NZ
! WRITE (IPR,128)
! DO 95 I=1,NEL
! WRITE (IPR,130) I,E(I),V(I),TH(I)
! 95 CONTINUE
! WRITE (IPR,132)
! RL = SQRT(FOR/(PRES*3.1416))
! WRITE (IPR,134) FOR,PRES,RL
! WRITE (IPR,136)

```

```

!      DO 96 I=1,NLD
!      WRITE (IPR,138) I,XL(I),YL(I)
!  96 CONTINUE
!      WRITE (IPR,140)
!      DO 97 I=1,NXY
!      WRITE (IPR,142) XP(I),YP(I)
!  97 CONTINUE
!      WRITE (IPR,144) (Z(I),I=1,NZ)
!      IF (IWARN .EQ. 1) then !WRITE (IPR,144)
!      else
!      RETURN
!      end if
40 continue
!  40 WRITE (IPR,45) NDIR,IVAL,(VAL(I),I=1,3),FROPT
!  45 FORMAT (1H1//5X,'ILLEGAL DIRECTIVE'//5X,A4,4X,I2,F10.0,2F5.0,A2)
!!
!! 50 IF (IOCLOS(IPR)) WRITE (1,1001)
!!
! 50 close(unit=IPR,iostat=CloseStatus)
!      if (CloseStatus>0) then
!          write(*,1001)
!      end if
1001 FORMAT (/1X,'TROUBLE CLOSING OUTPUT FILE IN SUBROUTINE READIN')
STOP
! 122 FORMAT (1H1,4X,'ELSYS5 - FIVE LAYERED ELASTIC SYSTEM - VERSION 4.0
! 1'//5X,'LATEST REVISION: 77/12/19 - J C OQUIN, S B SEEDS'//34X,'P R J
! 2ORDAHL, R CATALANO'//5X,'AUSTIN RESEARCH ENGINEERS, INC.'//5X,'SYSTE
! 3M NUMBER',I3)
! 124 FORMAT (/5X,20A4)
! 126 FORMAT (/5X,'NUMBER OF ELASTIC LAYERS ='//I3//5X,'NUMBER OF LOAD LOC
! 1ATIONS ='//I3//5X,'NUMBER OF X-Y RESULTS ='//3X,I3//5X,'NUMBER OF Z DE
! 3PTHs ='//6X,I3)
! 128 FORMAT (/15X,'ELASTIC POISSONS'//5X,'LAYER MODULUS RATIO',
! 1 6X,'THICKNESS (IN.)')
! 130 FORMAT (5X,I3,4X,F10.0,4X,F5.3,5X,F8.3)
! 132 FORMAT (/5X,'LOAD DESCRIPTION:')
! 134 FORMAT (/5X,'LOAD FORCE ='//3X,F10.0//5X,'TIRE PRESSURE ='//F10.0//5X,
! 1'LOAD RADIUS ='//2X,F10.2)
! 136 FORMAT (/9X,'LOADS LOCATED AT:'//5X,'LOAD'//5X,'X'//8X,'Y')
! 138 FORMAT (5X,I3,2F9.3)
! 140 FORMAT (/5X,'RESULTS REQUESTED FOR SYSTEM LOCATION(S)'//7X,'X-Y PO
! 1INT(S)'//8X,'X'//6X,'Y')
! 142 FORMAT (1X,F10.2,F6.2)
! 144 FORMAT (/7X,'DEPTHS ='//10F7.2)
! 146 FORMAT (/5X,'MORE THAN 10 DEPTHS HAVE BEEN SPECIFIED --- THOSE ',
! 1 'AFTER THE TENTH HAVE BEEN IGNORED')
END subroutine READIN
C*****
C
SUBROUTINE DEPTHS (NDIR,NDRSVE)
C
      use C_ELSYS
      use C_ELCOM
      use C_RDIN
      use C_DEPTH

CHARACTER*4 NDIR,NDRSVE
!      COMMON /ELSYS/ NEL, E(5), V(5), TH(5), CI, DI(5)
!      COMMON /ELCOM/ FOR, PRES, RL, NLD, XL(10),YL(10), NXY, NZ
!      . , XP(10),YP(10),Z(10),LAYZ(10)
!      . , SNRM(3,10,10), SSHR(3,10,10), PS(3,10,10)
!      . , PSS(3,10,10), DISP(3,10,10), ENRM(3,10,10)
!      . , ESHR(3,10,10), PE(3,10,10), PSE(3,10,10)
!      COMMON /RDIN/ YYYYY,IVAL,NSY,LCNT,VAL(3),TITLE(20),IVLSVE,SVVAL1,
! 1 XXXXX
!      COMMON /DEPTH/ THK(6), JZ(5), ZVAL(5,5), IWARN, IZ, LNUM(5)
!      THK(1) = 0.
!      DO 10 I=1,NEL
!      THK(I+1) = THK(I) + TH(I)
10 CONTINUE
NZ = 0

```

```

DO 40 I=1,IZ
L = LNUM(I)
J = JZ(I)
DO 30 K=1,J
NZ = NZ + 1
IF (NZ .GT. 10) GO TO 50
IF (ZVAL(I,K) .LT. 0.) GO TO 20
Z(NZ) = THK(L) + ZVAL(I,K)
GO TO 30
20 Z(NZ) = THK(L) + TH(L)
30 CONTINUE
40 CONTINUE
RETURN
50 IWARN = 1
NZ = 10
RETURN
END subroutine DEPTHS
C*****
C
SUBROUTINE ELPRS
CC
C ELPRS - PRESET ELASTIC LAYER PROCEDURE.
C
C THIS SUBROUTINE IS ONLY CALLED THE FIRST TIME ELSYM5
C IS EXECUTED. IT INITIALIZES STORAGE LOCATIONS WHICH ARE
C NOT CHANGED WHILE SOLUTIONS ARE BEING PERFORMED.
C
C THE NUMERICAL INTEGRATION TECHNIQUE USED FOR THE
C ELASTIC LAYER SOLUTIONS IS A 4 POINT GAUSSIAN QUADRATURE
C WITH NBZ = 46. CONSTANTS REQUIRED FOR THIS METHOD ARE
C DEVELOPED HERE.
C
use C_ELCTL
use C_BLANK
use C_ELPART
C *** EXCLUSIVE ROUTINE ARRAYS
DIMENSION BZ(46),GU(4)
C
! COMMON /ELCTL/ KSW1, KSW2, KSW3, KSW4, NBZ, NEI, NEX, NGQP
! . , NI, NLSW, NTEST, NTSI, NX, WRL
C
BLANK COMMON - USED AS WORKING STORAGE BY INPUT AND BY ELSYM5.
C
! COMMON ST1, ST2, ST3, ST4, TST1, TST2, TST3, TST4
! . , CDAB(5,736), AJ1(184), RJ0(184), RJ1(184), EX(32)
! COMMON /ELPART/ GP(184)
C
DATA BZ/ 1.0,
1 2.40482556 , 3.83170597 , 5.52007811 , 7.01558667 , 8.65372791 ,
2 10.1734681 , 11.7915344 , 13.3236919 , 14.9309177 , 16.4706301 ,
3 18.0710640 , 19.6158585 , 21.2116366 , 22.7600844 , 24.3524715 ,
4 25.9036721 , 27.4934791 , 29.0468285 , 30.6346065 , 32.1896799 ,
5 33.7758202 , 35.3323076 , 36.9170984 , 38.4747662 , 40.0584258 ,
6 41.6170942 , 43.1997917 , 44.7593190 , 46.3411884 , 47.9014609 ,
7 49.4826099 , 51.0435352 , 52.6240518 , 54.1855536 , 55.7655108 ,
8 57.3275254 , 58.9069839 , 60.4694578 , 62.0484692 , 63.6113567 ,
9 65.1899648 , 66.7532267 , 68.3314693 , 69.8950718 , 71.4729816 /
C
DATA GU /
1-.430568156 ,-.169990522 , .169990522 , .430568156 /
C
THIS DATA STATEMENT MOVED TO BLOCK DATA (FOR IBM)
DATA NBZ, NGQP / 46, 4 /
C
K3=0
FMB=0.0
DO 20 K1=1,NBZ
FM=BZ(K1)
SBA=(FM+FMB)/2.0
DBA=FM-FMB

```



```

        DO 10 K2=1,NGQP
          K3=K3+1
          GP(K3)=SBA+DBA*GU(K2)
10     CONTINUE
        FMB=FM
20    CONTINUE
        RETURN
C
        END subroutine ELPRS
C*****
C
        SUBROUTINE ELINIT
CC
        ELINIT - ELSYM5 INITIALIZATION ROUTINE.
C
        THIS SUBROUTINE SETS SYSTEM CONTROL VARIABLES AND FLAGS
C AS REQUIRED TO PERFORM THE CALCULATIONS SPECIFIED BY THE
C CALLER IN COMMON BLOCKS /ELSYS/ AND /ELCOM/.
C
        ENTRY:   INPUT VALUES SET IN /ELSYS/ AND /ELCOM/.
C
        EXIT:    DI  = ARRAY OF DEPTHS TO INTERFACES.
C              EX  = EXPONENT TEST ARRAY.
C              IXR = ARRAY OF POINTERS TO THE ELEMENT IN R WHICH
C                   GIVES THE DISTANCE FROM EACH XY POINT TO
C                   EACH LOAD.
C              KSW1 = 1 IF UNDERLYING BASE IS ELASTIC,
C                   = 2 IF RIGID UNDERLYING BASE.
C              KSW2 = 1 FOR FULL FRICTION RIGID BASE INTERFACE,
C                   = 2 FOR NO FRICTION RIGID BASE INTERFACE.
C              KSW3 = 1 IF FIRST RADIAL POINT NOT BENEATH LOAD,
C                   = 2 IF FIRST POINT DIRECTLY UNDER LOAD.
C              NEI  = NEL - 1
C              NI   = NUMBER OF INTERFACES.
C              NLSW = 3 FOR ONE ELASTIC LAYER,
C                   = 2 FOR TWO ELASTIC LAYERS,
C                   = 1 FOR THREE OR MORE ELASTIC LAYERS.
C              NR   = NUMBER OF RADIAL DISTANCES AT WHICH CALCULATIONS
C                   MUST BE MADE.
C              NX   = 1 IF RIGID BASE,
C                   = 2 IF ELASTIC BASE.
C              R    = ARRAY OF DISTANCES BETWEEN LOADS AND XY POINTS
C                   IN ASCENDING ORDER WITH DUPLICATE VALUES REMOVED.
C              RL   = RADIUS OF LOADED AREA.
C              RLP  = RADIUS OF LOAD * PRESSURE.
C              WR   = FIRST RADIAL DISTANCE AT WHICH CALCULATIONS
C                   WILL BE PERFORMED.
C
C
C
C *** EXCLUSIVE ROUTINE ARRAYS
C
        use C_CONST
        use C_ELCTL
        use C_ELCYLN
        use C_BLANK
        use C_ELSYS
        use C_ELCOM
C *** ERROR MESSAGES ARRAY
        CHARACTER*48 ERMSG(8)
        DIMENSION XR(100)
        integer:: CloseStatus
C
C /CONST/ - PROGRAM CONSTANTS.
C
! COMMON /CONST/ ICD,IPR,XK1,XK2,XK3,XK4,RLMIN,RLMNAC,
! 1 FLOC1,FLOC2,FVOID, ECRACK, EMBKUP, ECRACK2,ECRAK3,
! 2 DSNEAC, DSNLD, DSNPR, DBLDS, ZSBGM, THBBRL
! COMMON /ELCTL/ KSW1, KSW2, KSW3, KSW4, NBZ, NEI, NEX, NGQP
! . , NI, NLSW, NTEST, NTSI, NX, WRL

```

```

!      COMMON /ELCYLN/ NRC,NZC,LAY,NR,R(60),IXR(60),ANS(6,60,10)
!      .                , RSE, TSE, VSE, SSE, RDP, VDP, RLP, WR, WZ, LAY12
C
C      BLANK COMMON - USED AS WORKING STORAGE BY INPUT AND BY ELSYM5.
C
!      COMMON ST1, ST2, ST3, ST4, TST1, TST2, TST3, TST4
!      .                , CDAB(5,736), AJ1(184), RJ0(184), RJ1(184), EX(32)
!      COMMON /ELSYS/ NEL, E(5), V(5), TH(5), CI, DI(5)
!      COMMON /ELCOM/ FOR, PRES, RL, NLD, XL(10),YL(10), NXY, NZ
!      .                , XP(10),YP(10),Z(10),LAYZ(10)
!      .                , SNRM(3,10,10),SSHR(3,10,10),PS(3,10,10)
!      .                , PSS(3,10,10), DISP(3,10,10),ENRM(3,10,10)
!      .                , ESHR(3,10,10),PE(3,10,10), PSE(3,10,10)
C
C *** ERROR MESSAGES
DATA ERMMSG /
1 'NUMBER OF ELASTIC LAYERS OUTSIDE LIMIT OF 1 - 5 ',
2 'NUMBER OF XY VALUES OUTSIDE LIMIT OF 1 - 10   ',
3 'NUMBER OF Z VALUES OUTSIDE LIMIT OF 1 - 10   ',
4 'LOAD IMPROPERLY DESCRIBED                      ',
5 'ELASTIC LAYER DATA IMPROPER                   ',
6 'Z VALUE IMPROPER                               ',
7 'NUMBER OF LOADS OUTSIDE LIMIT OF 1 - 10        ',
8 'RIGID BASE INTERFACE IMPROPERLY DEFINED        '\
C
C
C *** ALPHA CONDITION OF INTERFACE
AFF = 2HFF
ANF = 2HNF
IND1=0
TST1=68.0
TST2=0.0001
C
C      TEST NUMBER OF ELASTIC LAYERS (NEL)
C      SET NUMBER OF LAYERS SWITCH (NLSW)
C
      IF (NEL-1) 500,10,20
C *** NLSW=3 FOR 1 ELASTIC LAYER
10 NLSW=3
   GO TO 50
20 IF (NEL-3) 30,40,40
C *** NLSW=2 FOR 2 ELASTIC LAYERS
30 NLSW=2
   GO TO 50
C *** NLSW=1 FOR 3 OR MORE ELASTIC LAYERS
40 NLSW=1
   IF (NEL-5) 50,50,500
C
C      TEST NUMBER OF LOADS (NLD), NUMBER OF XY VALUES (NXY), AND
C      NUMBER OF Z VALUES (NZ).
C
50 CONTINUE
   IF (NLD.LE.0.OR.NLD.GT.10) GO TO 560
   IF (NXY.LE.0.OR.NXY.GT.10) GO TO 510
   IF (NZ.LE.0.OR.NZ.GT.10) GO TO 520
C
C      TEST /ELSYS/ VALUES.
C
DO 110 K1=1,NEL
   IF (E(K1).LE.0.0) GO TO 540
   IF (V(K1).LE.0.0.OR.V(K1).GT.0.99) GO TO 540
   IF (K1.EQ.NEL) GO TO 60
   IF (TH(K1)) 540,540,110
C *** TEST BASE CONDITION
60   IF (TH(K1)) 540,70,80
C *** SET BASE CONDITION TO ELASTIC
70   NI=NEL-1
      NX=2
      KSW1=1
      GO TO 100
C *** SET BASE CONDITION TO RIGID

```

```

      80    NI=NEL
           NX=1
           KSW1=2
C *** CHECK BASE INTERFACE CONDITION
           IF (CI.NE.AFF) GO TO 90
           KSW2=1
           GO TO 100
      90    IF (CI.NE.ANF) GO TO 570
           KSW2=2
      100   NEI=NEL-1
      110   CONTINUE
C
C    COMPUTE LOAD RADIUS, CHECK VALUES OF FOR AND PRES.
C
           IF (FOR.LE.0.0) GO TO 530
           IF (PRES.LE.0.0) GO TO 530
           RL=SQRT(.3183099*FOR/PRES)
C
C    CHECK FOR NEGATIVE Z VALUES, SORT IN ASCENDING ORDER.
C
           DO 120 K1=1,NZ
               IF (Z(K1)) 550,120,120
      120   CONTINUE
           IF (NZ-1) 160,160,130
      130   K1=NZ-1
           DO 150 K2=1,K1
               K3=K2+1
           DO 150 K4=K3,NZ
               IF (Z(K2)-Z(K4)) 150,550,140
      140   TEMP=Z(K2)
               Z(K2)=Z(K4)
               Z(K4)=TEMP
      150   CONTINUE
C
C    DEVELOP DEPTH TO INTERFACE ARRAY (DI), AND EXPONENT TEST
C    ARRAY (EX).
C
      160   IF (NLSW .LT. 3) GO TO 180
      170   DI(1)=TH(1)
           EX(1)=0.0
           EX(2)=2.0*TH(1)
           GO TO 230
      180   DI(1)=TH(1)
           IF (NI.LT.2) GO TO 200
           DO 190 K1=2,NI
               DI(K1)=DI(K1-1)+TH(K1)
      190   CONTINUE
      200   NEX=2**NI
           K1=1
           K2=1
           EX(1)=0.0
           DO 220 K3=1,NEL
               K4=NEL+1-K3
               TEMP=2.0*TH(K4)
           DO 210 K5=1,K2
               K1=K1+1
               EX(K1)=TEMP+EX(K5)
      210   CONTINUE
           K2=K2*2
      220   CONTINUE
C
C    IF RIGID BASE, CHECK Z VALUES NOT TOO BIG AND V(NEL) NOT .75
C
      230   CONTINUE
           IF (KSW1.EQ.1) GO TO 250
           DINI=DI(NI)
           NZL=NZ
           DO 240 K1=1,NZL
               K2=NZ-K1+1
               IF (DINI+.0001.GE.Z(K2)) GO TO 240
           NZ=NZ-1

```

```

240 CONTINUE
    IF (ABS(V(NEL)-.75).LT..002) GO TO 540
C
C    DEVELOP R ARRAY BY LOAD WITHIN XY POINT
C
250 NR=NX*Y*MLD
    NXR=NR
    K1=1
    DO 260 K2=1,NXY
        XPI=XP(K2)
        YPI=YP(K2)
    DO 260 K3=1,NLD
        R(K1)=SQRT((YPI-YL(K3))**2+(XPI-XL(K3))**2)
        XR(K1)=R(K1)
        K1=K1+1
260 CONTINUE
C *** SORT R ARRAY IN ORDER OF INCREASING VALUE
    IF (NR.LE.1) GO TO 340
    K2=NR-1
    DO 270 K1=1,K2
        K3=K1+1
    DO 270 K4=K3,NR
        IF (R(K1).LE.R(K4)) GO TO 270
        TEMP=R(K1)
        R(K1)=R(K4)
        R(K4)=TEMP
270 CONTINUE
C
C    ELIMINATE NEAR DUPLICATE R VALUES.
C
    M = 1
290 IF (M .EQ. NR) GO TO 330
    M1 = M+1
300 IF (ABS(R(M)-R(M1)) .GE. .02) GO TO 320
    NR = NR-1
    DO 310 K1=M1,NR
        R(K1) = R(K1+1)
310 CONTINUE
    IF (M .EQ. NR) GO TO 330
    GO TO 300
320 M = M1
    GO TO 290
330 CONTINUE
C
C    DEVELOP IXR ARRAY AS A POINTER
C
340 DO 370 K1=1,NXR
    XRI=XR(K1)
    DO 360 K2=1,NR
        IF (ABS(XRI-R(K2))-0.02) 350,350,360
350     IXR(K1)=K2
        GO TO 370
360     CONTINUE
        WRITE (IPR,590)
!
!     IF (IOCLOS(IPR)) WRITE (1,1001)
!
        close(unit=IPR,iostat=CloseStatus)
        if (CloseStatus>0) then
            write(*,1001)
        end if
        WRITE (NSCRN,5770)
5770     FORMAT (/1X,'*** PROGRAM STOPPED DUE TO ERROR. CHECK OUTPUT FILE
        * FOR ERROR MESSAGE.'/1X,'STOPPED IN SUBROUTINE ELINIT AT 360.')
        STOP
370 CONTINUE
    IF (ABS(RL-R(1))-0.0001) 390,390,380
380 IF (RL-R(1)) 400,390,390
390 WRL=RL
    GO TO 410
400 WRL=R(1)

```

```

410 WR=R(1)
    IF (WR-0.0001) 420,420,430
420 WR=0.0
    KSW3=2
    GO TO 440
430 KSW3=1
440 NRC=1
C
C    WITH SORTED Z VALUES - ONLY HAVE TO TEST ONE VALUE
C    DETERMINE BACK SUBSTITUTION LIMIT
C
    ZT=Z(NZ)
    DO 450 K1=1,NEI
        NBL1=K1
        IF (ZT-DI(K1)) 460,460,450
450 CONTINUE
    NBL1=NEL
C
C    SET RELATIVE (PSI), OR ABSOLUTE OUTPUT
C
460 IF (IND1) 470,480,470
470 RLP=RL
    GO TO 490
480 RLP=RL*PRES
490 CONTINUE
    RETURN
C
C    INPUT DATA ERROR TRAP
C    SET ERROR INDICATOR
C
500 NER=1
    GO TO 580
510 NER=2
    GO TO 580
520 NER=3
    GO TO 580
530 NER=4
    GO TO 580
540 NER=5
    GO TO 580
550 NER=6
    GO TO 580
560 NER=7
    GO TO 580
570 NER=8
580 CONTINUE
    WRITE (IPR,600)
    WRITE (IPR,610) ERMSG(NER)
!
!    IF (IOCLOS(IPR)) WRITE (1,1001)
!
    close(unit=IPR,iostat=CloseStatus)
    if (CloseStatus>0) then
        write(*,1001)
    end if
!
1001 FORMAT (/1X,'TROUBLE CLOSING OUTPUT FILE IN SUBROUTINE ELINIT')
    WRITE (NSCRN,5773)
5773 FORMAT (/1X,'*** PROGRAM STOPPED, CHECK OUTPUT FILE FOR ERROR
* MESSAGE.'/1X,'STOPPED IN SUBROUTINE ELINIT AT 580.')
```

STOP

```

C
590 FORMAT (13H ERROR IN IXR)
600 FORMAT (1H0,4X,38HFATAL ERROR IN ELSYM5 INPUT PARAMETER0)
610 FORMAT (1H0,4X,A48)
C
    END subroutine ELINIT
C*****
C
SUBROUTINE ELSNGL
```

```

        use C_ELCTL
        use C_BLANK
        use C_ELPART
        use C_ELSYS

CC
C      ELSNGL - SINGLE LAYER ELASTIC SYSTEM.
C
C *** EXCLUSIVE ROUTINE ARRAYS
      DIMENSION SA(2,2)
C
!      COMMON /ELCTL/ KSW1, KSW2, KSW3, KSW4, NBZ, NEI, NEX, NGQP
!      .           , NI, NLSW, NTEST, NTSI, NX, WRL
C
C      BLANK COMMON - USED AS WORKING STORAGE BY INPUT AND BY ELSYM5.
C
!      COMMON ST1, ST2, ST3, ST4, TST1, TST2, TST3, TST4
!      .           , CDAB(5,736), AJ1(184), RJ0(184), RJ1(184), EX(32)
!      COMMON /ELPART/ GP(184)
!      COMMON /ELSYS/ NEL, E(5), V(5), TH(5), CI, DI(5)
C

      ST1=2.0*V(1)
      ST2=ST1-1.0
      IF (KSW1 .EQ. 1) GO TO 20
C *** SINGLE ELASTIC LAYER WITH RIGID BASE
      10 PC1=1.0/(3.0-4.0*V(1))
         PC2=1.0-4.0*V(1)
         PC3=2.0*PC1
         PC4=2.0*DI(1)
         PC5=PC4*DI(1)
         PC6=4.0*ST2
C *** END RIGID BASE ROUTINE
      20 K6=-3
         K5=0
         DO 110 K2=1,NBZ
         DO 110 K1=1,NGQP
            K6=K6+4
            K5=K5+1
            FM=GP(K5)/WRL
            RFM=1.0/FM
            RFM2=RFM*RFM
            IF (KSW1 .EQ. 1) GO TO 100
C *** SINGLE ELASTIC LAYER WITH RIGID BASE
      30 VAL=FM*EX(2)
C *** SINGLE ELASTIC LAYER WITH RIGID BASE REVERTS TO
C *** SINGLE ELASTIC LAYER WITH NO BASE WHEN VAL EXCEEDS TEST
      40 IF (VAL-TST1) 40,40,100
         VAL=EXP(-VAL)
         IF (KSW2 .EQ. 2) GO TO 60
C *** RIGID BASE WITH FULL FRICTION
      50 CM1=(PC2-FM*PC4)*PC1*VAL
         CM2=(PC6-FM*FM*PC5)*PC1*RFM*VAL
         CM3=PC3*FM*VAL
         CM4=(PC2+FM*PC4)*PC1*VAL
         SA(1,1)=FM+FM*CM1+ST1*CM3
         SA(1,2)=-ST1+FM*CM2+ST1*CM4
         SA(2,1)=-FM+FM*CM1+ST2*CM3
         SA(2,2)=ST2+FM*CM2+ST2*CM4
         GO TO 70
C *** RIGID BASE WITH NO FRICTION
      60 SA(1,1)=FM-FM*VAL
         SA(1,2)=-ST1+(ST1-2.0*FM*DI(1))*VAL
         SA(2,1)=-FM-FM*VAL
         SA(2,2)=ST2+(ST2-2.0*FM*DI(1))*VAL
      70 CDAB(1,K6)=-SA(1,2)*RFM2/(SA(2,1)*(-SA(1,2))+SA(2,2)*SA(1,1))
         CDAB(1,K6+1)=SA(1,1)*CDAB(1,K6)/(-SA(1,2))
         IF (KSW2 .EQ. 2) GO TO 90
C *** RIGID BASE WITH FULL FRICTION
      80 CDAB(1,K6+2)=CM1*CDAB(1,K6)+CM2*CDAB(1,K6+1)

```

```

        CDAB(1,K6+3)=CM3*CDAB(1,K6)+CM4*CDAB(1,K6+1)
        GO TO 110
C *** RIGID BASE WITH NO FRICTION
  90   CDAB(1,K6+2)=- (CDAB(1,K6)+2.0*DI(1)*CDAB(1,K6+1)) *VAL
        CDAB(1,K6+3)=CDAB(1,K6+1)*VAL
        GO TO 110
C *** SINGLE ELASTIC LAYER - NO BASE
 100   CDAB(1,K6)=-ST1*RFM2*RFM
        CDAB(1,K6+1)=-RFM2
        CDAB(1,K6+2)=0.0
        CDAB(1,K6+3)=0.0
110 CONTINUE
    RETURN
C
    END subroutine ELSNGL
C*****
C
    SUBROUTINE ELPCC

        use C_ELCTL
        use C_ELCOEF
        use C_ELSYS
CC
C    ELPCC - PRESET COEFFICIENT CALCULATIONS FOR MULTI-LAYER SYSTEM.
C
C *** EXCLUSIVE ROUTINE ARRAYS
    DIMENSION RDET(4)
C
!    COMMON /ELCTL/ KSW1, KSW2, KSW3, KSW4, NBZ, NEI, NEX, NGQP
!    .           , NI, NLSW, NTEST, NTSI, NX, WRL
!    COMMON /ELCOEF/
!    1 EI(16,2,2),S(2,2,2),SV(4,9),ISC(4),SA(2,2),RB(2,2),BA(2,2,2),
!    2 TB1,TB2,TB3,TB4,TB5,
!    3 NE,NEXD2,NEIM1
!    COMMON /ELSYS/ NEL, E(5), V(5), TH(5), CI, DI(5)
C
    DO 10 K1=1,NEI
        RDET(K1)=1.0/(4.0*(1.0-V(K1)))
10 CONTINUE
    NEXD2=NEX/2
    NEIM1=NEI-1
    NE=NEIM1*4+1
C *** DEVELOP ISC ARRAY
    ISC(NEI)=1
    IF (NLSW .EQ. 2) GO TO 40
20 DO 30 K1=1,NEIM1
        K2=NEI-K1
        ISC(K2)=ISC(K2+1)*2
30 CONTINUE
40 K1=1
    DO 50 K2=1,NE,4
        T1=(1.0+V(K1+1))*E(K1)/(E(K1+1)*(1.0+V(K1)))
        T2=1.0-T1
C *** ELEMENTS TOTALLY INDEPENDENT OF M
        EI(K2,1,1)=(-4.0*V(K1)+T1+3.0)*RDET(K1)
        EI(K2+3,1,1)=EI(K2,1,1)
        EI(K2,2,2)=(-T1*(4.0*V(K1+1)-3.0)+1.0)*RDET(K1)
        EI(K2+3,2,2)=EI(K2,2,2)
        EI(K2,2,1)=0.0
        EI(K2+3,2,1)=0.0
C *** PORTIONS OF ELEMENTS INDEPENDENT OF M
        SV(K1,1)=(-2.0*DI(K1)*(2.0*V(K1)-1.0-T1*(2.0*V(K1+1)-1.0)))*RDE
1    T(K1)
        SV(K1,2)=(-T2*(4.0*V(K1)-1.0))*RDET(K1)
        SV(K1,3)=(-4.0*DI(K1)*(T2*(V(K1)-V(K1+1))))*RDET(K1)
        SV(K1,4)=(-T2*(4.0*V(K1+1)-1.0))*RDET(K1)
C *** PORTION OF ELEMENTS DEPENDENT ON 1.0/M
        SV(K1,5)=(1.0+2.0*V(K1+1))*(4.0*V(K1)-3.0)-T1*(1.0+2.0*V(K1))*(4.
1    0*V(K1+1)-3.0))*RDET(K1)
        SV(K1,6)=(1.0-2.0*V(K1+1))*(4.0*V(K1)-1.0)-T1*(1.0-2.0*V(K1))*(4.
1    0*V(K1+1)-1.0))*RDET(K1)

```

```

C *** PORTIONS OF ELEMENTS DEPENDENT ON M
      T1=(-2.0*T2)*RDET(K1)
      SV(K1,7)=-DI(K1)*T1
      SV(K1,8)=-DI(K1)**2*T1
      SV(K1,9)=T1
      K1=K1+1
50 CONTINUE
C *** SET UP SURFACE ARRAY ELEMENTS INDEPENDENT OF M
      S(1,1,2)=-2.0*V(1)
      S(1,2,2)=2.0*V(1)-1.0
      S(2,1,2)=2.0*V(1)
      S(2,2,2)=2.0*V(1)-1.0
      IF (KSW1 .EQ. 1) GO TO 70
C *** RIGID BASE WITH ROUGH INTERFACE
60 T1=3.0-4.0*V(NEL)
C *** PORTIONS OF RIGID BASE ELEMENTS INDEPENDENT OF M
      TB1=(1.0-4.0*V(NEL))/T1
C *** PORTIONS OF RIGID BASE ELEMENTS DEPENDENT ON M
      TB3=2.0/T1
      TB4=TB3*DI(NI)
      TB5=TB4*DI(NI)
C *** PORTIONS OF RIGID BASE ELEMENTS DEPENDENT ON 1.0/M
      TB2=4.0*(2.0*V(NEL)-1.0)/T1
70 RETURN
C
      END subroutine ELPC
C*****
C
      SUBROUTINE ELDEVL ( FM )

          use C_ELCTL
          use C_ELCOEF
          use C_ELSYS

CC
C      ELDEVL - DEVELOP EI(K,I,J), S(K,I,J), AND RB(I,J) ARRAYS FOR FM.
C
!      COMMON /ELCTL/ KSW1, KSW2, KSW3, KSW4, NBZ, NEI, NEX, NGQP
!      .
!      COMMON /ELCOEF/
!      1 EI(16,2,2),S(2,2,2),SV(4,9),ISC(4),SA(2,2),RB(2,2),BA(2,2,2),
!      2 TB1,TB2,TB3,TB4,TB5,
!      3 NE,NEXD2,NEIM1
!      COMMON /ELSYS/ NEL, E(5), V(5), TH(5), CI, DI(5)
C
      RFM=1.0/FM
      K1=1
C *** SET UP ELEMENTS DEPENDENT ON M AND 1.0/M
      DO 10 K2=1,NE,4
          EI(K2,1,2)=SV(K1,1)+RFM*SV(K1,5)
          EI(K2+1,1,1)=SV(K1,2)+FM*SV(K1,7)
          EI(K2+1,1,2)=SV(K1,3)+FM*SV(K1,8)+RFM*SV(K1,6)
          EI(K2+1,2,1)=FM*SV(K1,9)
          EI(K2+1,2,2)=SV(K1,4)-FM*SV(K1,7)
          EI(K2+2,1,1)=SV(K1,2)-FM*SV(K1,7)
          EI(K2+2,1,2)=SV(K1,3)-FM*SV(K1,8)-RFM*SV(K1,6)
          EI(K2+2,2,1)=-FM*SV(K1,9)
          EI(K2+2,2,2)=SV(K1,4)+FM*SV(K1,7)
          EI(K2+3,1,2)=SV(K1,1)-RFM*SV(K1,5)
          K1=K1+1
10 CONTINUE
C *** SET UP SURFACE ARRAY ELEMENTS THAT ARE DEPENDENT ON M
      S(1,1,1)=FM
      S(1,2,1)=-FM
      S(2,1,1)=FM
      S(2,2,1)=FM
      IF (KSW1 .EQ. 1) GO TO 90
      IF (KSW2 .EQ. 2) GO TO 40
C *** RIGID BASE WITH FULL FRICTION
30 RB(1,1)=TB1-FM*TB4
      RB(1,2)=RFM*TB2-FM*TB5
      RB(2,1)=FM*TB3

```



```

        RB(2,2)=TB1+FM*TB4
        GO TO 50
C *** RIGID BASE WITH NO FRICTION
40 RB(1,1)=-1.0
    RB(1,2)=-2.0*DI(NI)
    RB(2,1)=0.0
    RB(2,2)=1.0
50 K7=1
    K1=NE+1
    K3=K1+2
    DO 80 K2=K1,K3,2
        DO 70 K4=1,2
        DO 70 K5=1,2
            SUM=0.0
            DO 60 K6=1,2
                SUM=SUM+EI(K2,K4,K6)*RB(K6,K5)
60     CONTINUE
        BA(K7,K4,K5)=SUM
70     CONTINUE
        K7=K7+1
80 CONTINUE
90 RETURN
C
    END subroutine ELDEVL
C*****
C
    SUBROUTINE ELMULT ( FM )

        use C_ELCTL
        use C_BLANK
        use C_ELCOEF

CC
C     ELMULT - MULTIPLY S(K,I,J) AND EI(K,I,J) FOR ALL FM VALUES.
C
C *** EXCLUSIVE ROUTINE ARRAYS
    DIMENSION TP(5,2,2),ITA(4),ITAB(4),SEI(2,2,2)
C
    !     COMMON /ELCTL/ KSW1, KSW2, KSW3, KSW4, NBZ, NEI, NEX, NGQP
    !     .           , NI, NLSW, NTEST, NTSI, NX, WRL
C
    BLANK COMMON - USED AS WORKING STORAGE BY INPUT AND BY ELSYM5.
C
    !     COMMON ST1, ST2, ST3, ST4, TST1, TST2, TST3, TST4
    !     .           , CDAB(5,736), AJ1(184), RJ0(184), RJ1(184), EX(32)
    !     COMMON /ELCOEF/
    !     1 EI(16,2,2),S(2,2,2),SV(4,9),ISC(4),SA(2,2),RB(2,2),BA(2,2,2),
    !     2 TB1,TB2,TB3,TB4,TB5,
    !     3 NE,NEXD2,NEIM1
C

    RFM=1.0/FM
    IF (KSW1 .EQ. 1) GO TO 30
C *** START RIGID BASE ROUTINE
10 K6=0
    K1=NE+1
    K3=K1+2
    DO 20 K2=K1,K3,2
        K6=K6+1
        DO 20 K4=1,2
        DO 20 K5=1,2
            SEI(K6,K5,K4)=EI(K2,K5,K4)
            EI(K2,K5,K4)=BA(K6,K5,K4)
20 CONTINUE
C *** END RIGID BASE ROUTINE
30 DO 40 K1=1,2
    DO 40 K2=1,2
        SA(K1,K2)=0.0
40 CONTINUE
    ITAB(1)=3
    K5=1

```

```

DO 200 K1=1,2
DO 50 K2=1,2
DO 50 K3=1,2
TP(1,K2,K3)=S(K1,K2,K3)
50 CONTINUE
DO 190 K4=1,NEXD2
C *** CHECK EXPONENT VALUE
VAL=FM*EX(K5)
IF (VAL-TST1) 60,60,180
60 VAL=EXP(-VAL)
C *** DEVELOP INDEX TO ADD ARRAY
DO 100 K2=1,NEI
IT=K5-1
70 ITT=IT/ISC(K2)
IF (ITT-3) 90,90,80
80 IT=IT-4*ISC(K2)
GO TO 70
90 ITA(K2)=ITT
100 CONTINUE
C *** CHECK AGAINST BACK INDEX TO ADD ARRAY
DO 110 K2=1,NEI
K3=K2
IF (ITA(K2)-ITAB(K2)) 120,110,120
110 CONTINUE
C *** K3 IS NOW THE INDEX FOR THE TP AND THE ITA ARRAYS
C *** SET ITA BACK ARRAY
DO 120 K2=1,NEI
ITAB(K2)=ITA(K2)
120 CONTINUE
K2=(K3-1)*4+1
DO 160 K10=K2,NE,4
K6=K10+ITA(K3)
DO 150 K7=1,2
DO 150 K8=1,2
SUM=0.0
DO 140 K9=1,2
SUM=SUM+TP(K3,K7,K9)*EI(K6,K9,K8)
140 CONTINUE
TP(K3+1,K7,K8)=SUM
150 CONTINUE
K3=K3+1
160 CONTINUE
DO 170 K7=1,2
DO 170 K8=1,2
SA(K7,K8)=SA(K7,K8)+TP(K3,K7,K8)*VAL
170 CONTINUE
180 K5=K5+NX
190 CONTINUE
200 CONTINUE
IF (KSW1 .EQ. 1) GO TO 230
C *** START RIGID BASE ROUTINE
C *** REPLACE BOTTOM EI ELEMENTS
210 K6=0
K1=NE+1
K3=K1+2
DO 220 K2=K1,K3,2
K6=K6+1
DO 220 K4=1,2
DO 220 K5=1,2
EI(K2,K5,K4)=SEI(K6,K5,K4)
220 CONTINUE
C *** END RIGID BASE ROUTINE
230 RETURN
C
END subroutine ELMULT
C*****
C
SUBROUTINE ELBKS ( FM,M )

use C_ELCTL
use C_BLANK

```

```

      use C_ELCOEF
      use C_ELSYS

CC
C   ELBKS - BACK SOLVE FOR A(I,J),B(I,J),C(I,J) AND D(I,J).
C
C *** EXCLUSIVE ROUTINE ARRAYS
      DIMENSION VA(4)
C
      !       COMMON /ELCTL/ KSW1, KSW2, KSW3, KSW4, NBZ, NEI, NEX, NGQP
      !       .           , NI, NLSW, NTEST, NTSI, NX, WRL
C
C   BLANK COMMON - USED AS WORKING STORAGE BY INPUT AND BY ELSYM5.
C
      !       COMMON ST1, ST2, ST3, ST4, TST1, TST2, TST3, TST4
      !       .           , CDAB(5,736), AJ1(184), RJ0(184), RJ1(184), EX(32)
      !       COMMON /ELCOEF/
      !       1 EI(16,2,2),S(2,2,2),SV(4,9),ISC(4),SA(2,2),RB(2,2),BA(2,2,2),
      !       2 TB1,TB2,TB3,TB4,TB5,
      !       3 NE,NEXD2,NEIM1
      !       COMMON /ELSYS/ NEL, E(5), V(5), TH(5), CI, DI(5)
C

      VA(1)=1.0
      VA(4)=1.0
      RFM=1.0/FM
      CDAB(NEL,M)=-SA(1,2)*RFM*RFM/(-SA(2,1)*SA(1,2)+SA(2,2)*SA(1,1))
      CDAB(NEL,M+1)=SA(1,1)*CDAB(NEL,M)/(-SA(1,2))
      IF (KSW1.EQ. 1) GO TO 30
C *** START RIGID BASE ROUTINE
      10 VAL=FM*DI(NI)*2.0
      IF (VAL-TST1) 20,20,30
      20 VAL=EXP(-VAL)
      CDAB(NEL,M+2)=(RB(1,1)*CDAB(NEL,M)+RB(1,2)*CDAB(NEL,M+1))*VAL
      CDAB(NEL,M+3)=(RB(2,1)*CDAB(NEL,M)+RB(2,2)*CDAB(NEL,M+1))*VAL
      GO TO 40
C *** END RIGID BASE ROUTINE
      30 CDAB(NEL,M+2)=0.0
      CDAB(NEL,M+3)=0.0
      40 DO 140 K10=1,NEI
      K11=NEI-K10+1
      MP3=M+3
      DO 50 K1=M,MP3
      CDAB(K11,K1)=0.0
      50 CONTINUE
      K12=K11+1
      K13=(K11-1)*4+1
      VAL=2.0*FM*DI(K11)
      IF (VAL-TST1) 70,70,60
      60 K6=1
      K4=1
      GO TO 100
      70 VA(2)=EXP(-VAL)
      K4=2
      VA(3)=1.0/VA(2)
      IF (CDAB(K12,M+2)) 90,80,90
      80 K6=1
      GO TO 100
      90 K6=2
      100 K8=M-2
      K7=0
      DO 130 K5=1,K6
      K2=M-1
      K8=K8+2
      K9=K8+1
      DO 120 K3=1,K4
      K7=K7+1
      DO 110 K1=1,2
      K2=K2+1
      CDAB(K11,K2)=CDAB(K11,K2)+VA(K7)*(EI(K13,K1,1)*CDAB(K1
1      2,K8)+EI(K13,K1,2)*CDAB(K12,K9))

```

```

110          CONTINUE
            K13=K13+2
120          CONTINUE
            K13=K13-3
130          CONTINUE
140          CONTINUE
            RETURN
C
      END subroutine ELBKS

      FUNCTION BESSEL (X,N)
CC
C      BESSEL - EVALUATE N-TH ORDER BESSEL FUNCTION (N = 0, 1 OR 2).
C
C *** EXCLUSIVE ROUTINE ARRAYS
      DIMENSION B1(12),B2(5),B3(5),B4(12),B5(5),B6(5)
      DIMENSION B7(12),B8(5),B9(5)
C
      DATA B1      /-.000000003 , .000000076 ,
1- .000001762 , .000032460 ,-.000460626 , .004819180 ,-.034893769 ,
2  .158067102 ,-.370094994 , .265178613 ,-.008723442 , .315455943 /
      DATA B2      /
1- .000000001 , .000000018 ,-.000000741 , .000068385 ,-.031111709 /
      DATA B3      /
1  .000000002 ,-.000000052 , .000003075 ,-.000536522 , 1.99892070 /
C
      DATA B4      /-.000000001 , .000000029 ,
1- .000000762 , .000015887 ,-.000260444 , .003240270 ,-.029175525 ,
2  .177709120 ,-.661443934 , 1.28799410 ,-.1.19180120 , 1.29671754 /
      DATA B5      /
1  .000000001 ,-.000000021 , .000000914 ,-.000096277 , .093555574 /
      DATA B6      /
1- .000000002 , .000000062 ,-.000003987 , .000898990 , 2.00180610 /
C
      DATA B7      / 0.0          , .000000010 ,
1- .000000300 , .0000006870 ,-.000127390 , .001829980 ,-.019569010 ,
2  .147707600 ,-.730405480 , 2.13203940 ,-.3.30639360 , 3.32384070 /
      DATA B8      /
1  0.0          , .000000040 ,-.000001730 , .000293150 , .469339820 /
      DATA B9      /
1  0.0          ,-.000000112 , .000008970 ,-.006371780 , 1.98723830 /
C
      NM1 = N - 1
      IF (X-8.) 10,10,50
10  XZ=X*X*.0625-2.
      IF (NM1) 20, 30, 40
20  BESS=CHEB(B1,12,XZ)
      GO TO 90
30  BESS=X*CHEB(B4,12,XZ)/8.0
      GO TO 90
40  BESS=X*X/64.0*CHEB(B7,12,XZ)
      GO TO 90
50  XZ=256./(X*X)-2.0
      A=0.78539816
      B=2.3561945
      C=0.797884561
      D=3.9269908
      IF (NM1) 60, 70, 80
60  BESS=- (8.0/X)*CHEB(B2,5,XZ)*SIN(X-A)
      BESS=BESS+CHEB(B3,5,XZ)*COS(X-A)
      BESS=BESS*C/SQRT(X)
      GO TO 90
70  BESS=- (8.0/X)*CHEB(B5,5,XZ)*SIN(X-B)
      BESS=BESS+CHEB(B6,5,XZ)*COS(X-B)
      BESS=BESS*C/SQRT(X)
      GO TO 90
80  BESS=- (8.0/X)*CHEB(B8,5,XZ)*SIN(X-D)
      BESS=BESS+CHEB(B9,5,XZ)*COS(X-D)
      BESS=BESS*C/SQRT(X)
90  BESSEL=BESS
      RETURN

```

```

C
END function BESSEL

FUNCTION CHEB (A,N,Z)
CC
C CHEB - CHEBYACHEV EVALUATION FOR BESSEL.
C
DIMENSION A(5),B(14)
! change A(12) to A(5)
B(1)=0.
B(2)=0.
DO 10 I=1,N
B(I+2)=Z*B(I+1)-B(I)+A(I)
10 CONTINUE
CHEB=.5*(B(N+2)-B(N))
RETURN
C
END function CHEB
C*****
C
SUBROUTINE ELCALC

use C_ELCTL
use C_ELCYLN
use C_BLANK
use C_ELPART
use C_ELSYS
use C_ELCOM

CC
C ELCALC - CALCULATE ELASTIC LAYER RESPONSES AT CURRENT POINT.
C
C *** EXCLUSIVE ROUTINE ARRAYS
DIMENSION GF(4),TEST(11)
C
! COMMON /ELCTL/ KSW1, KSW2, KSW3, KSW4, NBZ, NEI, NEX, NGQP
! . , NI, NLSW, NTEST, NTSI, NX, WRL
! COMMON /ELCYLN/ NRC,NZC,LAY,NR,R(60),IXR(60),ANS(6,60,10)
! . , RSE, TSE, VSE, SSE, RDP, VDP, RLP, WR, WZ, LAY12
C
BLANK COMMON - USED AS WORKING STORAGE BY INPUT AND BY ELSYM5.
C
! COMMON ST1, ST2, ST3, ST4, TST1, TST2, TST3, TST4
! . , CDAB(5,736), AJ1(184), RJ0(184), RJ1(184), EX(32)
! COMMON /ELPART/ GP(184)
! COMMON /ELSYS/ NEL, E(5), V(5), TH(5), CI, DI(5)
! COMMON /ELCOM/ FOR, PRES, RL, NLD, XL(10),YL(10), NXY, NZ
! . , XP(10),YP(10),Z(10),LAYZ(10)
! . , SNRM(3,10,10),SSHR(3,10,10),PS(3,10,10)
! . , PSS(3,10,10), DISP(3,10,10),ENRM(3,10,10)
! . , ESHR(3,10,10),PE(3,10,10), PSE(3,10,10)
C
DATA GF /
1 .173927423 , .326072577 , .326072577 , .173927423 /
DATA DIV / .861136312 /
C
ITS=1
VSE=0.0
SSE=0.0
RDP=0.0
VDP=0.0
RSE=0.0
TSE=0.0
ST1=2.0*V(LAY)
ST2=1.0-ST1
ST3=2.0*ST2
ST4=1.0+ST1
KSW5=1
KSW6=1
NAB=0

```

```

NBZC=0
K1=0
K2=-3
DO 270 K3=1,NBZ
  S1=0.0
  S2=0.0
  S3=0.0
  S4=0.0
  S5=0.0
  S6=0.0
  NBZC=NBZC+1
  DO 170 K4=1,NGQP
    K1=K1+1
    K2=K2+4
    FM=GP(K1)/WRL
  IF (KSW4 .EQ. 1) GO TO 20
10  VAL=1.0
    GO TO 50
20  VAL=FM*WZ
    IF (VAL-TST1) 40,40,30
30  KSW6=2
    GO TO 170
40  VAL=EXP(VAL)
50  T2=FM*AJ1(K1)*GF(K4)
  IF (KSW3 .EQ. 1) GO TO 70
60  T1=FM*T2
    GO TO 80
70  T1=T2*RJ0(K1)
    T2=T2*RJ1(K1)
    T3=FM*T1
C *** C - D SECTION
80  D=CDAB(LAY,K2+1)
    CD=FM*(CDAB(LAY,K2)+D*WZ)/VAL
    DE=D/VAL
  IF (KSW3 .EQ. 1) GO TO 100
90  S1=S1+T1*(ST2*DE+CD)
    S4=S4+T2*(-ST3*DE-CD)
C *** FORMULAS CHANGED FROM
C   S5=S5+T1*(ST4*DE-CD)
C   S6=S6+T1*DE
C *** TO
    S5=S5+T1*((ST1+0.5)*DE-0.5*CD)
    GO TO 110
100 S1=S1+T3*(ST2*DE+CD)
    S2=S2+FM*T2*(-ST1*DE+CD)
    S3=S3+T2*(DE-CD)
    S4=S4-T1*(ST3*DE+CD)
    S5=S5+T3*(ST4*DE-CD)
    S6=S6+T3*DE
C *** A - B SECTION
110 IF (KSW5 .EQ. 2) GO TO 170
120 B=CDAB(LAY,K2+3)
    IF (B) 140,130,140
130 KSW5=2
    NAB=NBZC
    GO TO 170
140 AB=FM*(CDAB(LAY,K2+2)+B*WZ)*VAL
    BE=B*VAL
  IF (KSW3 .EQ. 1) GO TO 160
150 S1=S1+T1*(ST2*BE-AB)
    S4=S4+T2*(ST3*BE-AB)
C *** FORMULAS CHANGED FROM
C   S5=S5+T1*(ST4*BE+AB)
C   S6=S6+T1*BE
C *** TO
    S5=S5+T1*((ST1+0.5)*BE+0.5*AB)
    GO TO 170
160 S1=S1+T3*(ST2*BE-AB)
    S2=S2+FM*T2*(ST1*BE+AB)
    S3=S3+T2*(BE+AB)
    S4=S4+T1*(ST3*BE-AB)

```

```

        S5=S5+T3*(ST4*BE+AB)
        S6=S6+T3*BE
170    CONTINUE
        SF=(GP(K1)-GP(K1-3))/(DIV*WRL)
        VSE=VSE+S1*SF
        VDP=VDP+S4*SF
        IF (KSW3 .EQ. 1) GO TO 190
180    RSE=RSE+S5*SF
C *** FORMULAS CHANGED FROM
C     TSE=TSE+ST1*S6*SF
C *** TO
        TSE=RSE
        GO TO 200
190    SSE=SSE+S2*SF
        RDP=RDP+S3*SF
        RSE=RSE+SF*(S5-S3/WR)
        TSE=TSE+SF*(ST1*S6+S3/WR)
200    TESTH=ABS(2.0*S1*RL*SF)-TST2
        IF (ITS-NTSI) 210,220,220
210    TEST(ITS)=TESTH
        ITS=ITS+1
        GO TO 260
220    TEST(NTSI)=TESTH
        DO 250 K4=1,NTTEST
            IF (TESTH-TEST(K4)) 230,240,240
230        TESTH=TEST(K4)
240        TEST(K4)=TEST(K4+1)
250    CONTINUE
        IF (TESTH) 280,280,260
260    IF (KSW6 .EQ. 2) GO TO 290
270    CONTINUE
        IND=1
        GO TO 300
280    IND=2
        GO TO 300
290    IND=3
300    RETURN
C
        END subroutine ELCALC
C*****
C
        SUBROUTINE ELSRP

                use C_ELCYLN
                use C_ELSYS

CC
C     ELSRP - STORE ELASTIC RESPONSE FOR SINGLE CYLINDRICAL POINT.
C
C *** EXCLUSIVE ROUTINE ARRAYS
        DIMENSION A(6)
C
!     COMMON /ELCYLN/ NRC,NZC,LAY,NR,R(60),IXR(60),ANS(6,60,10)
!     .           , RSE, TSE, VSE, SSE, RDP, VDP, RLP, WR, WZ, LAY12
!     COMMON /ELSYS/ NEL, E(5), V(5), TH(5), CI, DI(5)
C
        A(1)=RSE*RLP
        A(2)=TSE*RLP
        A(3)=VSE*RLP
        A(4)=SSE*RLP
        A(5)=(1.0+V(LAY))/E(LAY)*RDP*RLP
        A(6)=(1.0+V(LAY))/E(LAY)*VDP*RLP
        ANS(1,NRC,NZC)=A(1)
        ANS(2,NRC,NZC)=A(2)
        ANS(3,NRC,NZC)=A(3)
        ANS(4,NRC,NZC)=A(4)
        ANS(5,NRC,NZC)=A(5)
        ANS(6,NRC,NZC)=A(6)
        RETURN
C
        END subroutine ELSRP
C*****

```

```

C
SUBROUTINE ELOUT

      use C_ELCYLN
      use C_ELSYS
      use C_ELCOM
CC
C   ELOUT - OUTPUT RESULTS OF ELASTIC LAYER SYMULATION IN /ELCOM/.
C
C   THIS SUBROUTINE CONVERTS THE RESULTS, WHICH WERE CALCULATED
C   USING CYLINDRICAL COORDINATES AND A SINGLE LOAD, TO CARTESIAN
C   COORDINATES WITH SUPERPOSITION OF LOADS. IT ALSO CALCULATES
C   THE PRINCIPAL STRESSES AND STRAINS.
C
C *** EXCLUSIVE ROUTINE ARRAYS
      DIMENSION A(6),SET(3,3),DC(3,3),T(3)
C
      ! COMMON /ELCYLN/ NRC,NZC,LAY,NR,R(60),IXR(60),ANS(6,60,10)
      ! .           , RSE, TSE, VSE, SSE, RDP, VDP, RLP, WR, WZ, LAY12
      ! COMMON /ELSYS/ NEL, E(5), V(5), TH(5), CI, DI(5)
      ! COMMON /ELCOM/ FOR, PRES, RL, NLD, XL(10),YL(10), NXY, NZ
      ! .           , XP(10),YP(10),Z(10),LAYZ(10)
      ! .           , SNRM(3,10,10),SSHR(3,10,10),PS(3,10,10)
      ! .           , PSS(3,10,10), DISP(3,10,10),ENRM(3,10,10)
      ! .           , ESHR(3,10,10),PE(3,10,10), PSE(3,10,10)
C
C   LOOP THROUGH ENTIRE ROUTINE ONCE FOR EACH DEPTH.
C
      DO 120 NZB=1,NZ
      NZC = NZB
      LAY=LAYZ(NZC)
      ELAY=E(LAY)
      VLAY=V(LAY)
      SSC=2.0*(1.0+VLAY)/ELAY
      DO 10 K2=1,NXY
      DO 10 K1=1,3
      SNRM(K1,K2,NZC)=0.0
      SSHR(K1,K2,NZC)=0.0
      PS(K1,K2,NZC)=0.0
      PSS(K1,K2,NZC)=0.0
      DISP(K1,K2,NZC)=0.0
      ENRM(K1,K2,NZC)=0.0
      ESHR(K1,K2,NZC)=0.0
      PE(K1,K2,NZC)=0.0
      PSE(K1,K2,NZC)=0.0
10    CONTINUE
      K9=1
C
C   CALCULATE RESPONSES AT EACH XY POINT FOR CURRENT DEPTH.
C
      DO 110 NXYC=1,NXY
      XPI=XP(NXYC)
      YPI=YP(NXYC)
      DO 60 NLDC=1,NLD
      IR=IXR(K9)
      DO 20 K1=1,6
      A(K1)=ANS(K1,IR,NZC)
20    CONTINUE
      RI=R(IR)
      IF (RI-.001) 40,40,30
30    SINT=(YPI-YL(NLDC))/RI
      SINT2=SINT**2
      COST=(XPI-XL(NLDC))/RI
      COST2=COST**2
      SNRM(1,NXYC,NZC)=SNRM(1,NXYC,NZC)+COST2*A(1)+SINT2*A(2)
      SNRM(2,NXYC,NZC)=SNRM(2,NXYC,NZC)+COST2*A(2)+SINT2*A(1)
      SNRM(3,NXYC,NZC)=SNRM(3,NXYC,NZC)+A(3)
      SSHR(1,NXYC,NZC)=SSHR(1,NXYC,NZC)+COST*SINT*(A(1)-A(2))
      SSHR(2,NXYC,NZC)=SSHR(2,NXYC,NZC)+COST*A(4)
      SSHR(3,NXYC,NZC)=SSHR(3,NXYC,NZC)+SINT*A(4)
      DISP(1,NXYC,NZC)=DISP(1,NXYC,NZC)+COST*A(5)

```



```

DISP(2,NXYC,NZC)=DISP(2,NXYC,NZC)+SINT*A(5)
DISP(3,NXYC,NZC)=DISP(3,NXYC,NZC)+A(6)
GO TO 50
C
40     SNRM(1,NXYC,NZC)=SNRM(1,NXYC,NZC)+A(1)
      SNRM(2,NXYC,NZC)=SNRM(2,NXYC,NZC)+A(2)
      SNRM(3,NXYC,NZC)=SNRM(3,NXYC,NZC)+A(3)
      SSHR(2,NXYC,NZC)=SSHR(2,NXYC,NZC)+A(4)
      DISP(1,NXYC,NZC)=DISP(1,NXYC,NZC)+A(5)
      DISP(3,NXYC,NZC)=DISP(3,NXYC,NZC)+A(6)
50     K9=K9+1
60     CONTINUE
      DO 70 K1=1,3
        SET(K1,K1)=SNRM(K1,NXYC,NZC)
70     CONTINUE
      SET(1,2)=SSHR(1,NXYC,NZC)
      SET(1,3)=SSHR(2,NXYC,NZC)
      SET(2,3)=SSHR(3,NXYC,NZC)
      SET(2,1)=SET(1,2)
      SET(3,1)=SET(1,3)
      SET(3,2)=SET(2,3)
      CALL ELSMTX (SET,DC,3,0)
      DO 80 K1=1,3
        T(K1)=SET(K1,K1)
80     CONTINUE
      DO 100 K1=1,2
        K2=K1+1
      DO 100 K3=K2,3
        IF (T(K1)-T(K3)) 90,100,100
90     TEMP=T(K1)
        T(K1)=T(K3)
        T(K3)=TEMP
100    CONTINUE
      PS(1,NXYC,NZC)=T(1)
      PS(2,NXYC,NZC)=T(2)
      PS(3,NXYC,NZC)=T(3)
      PSS(1,NXYC,NZC)=0.5*(T(1)-T(3))
      PSS(2,NXYC,NZC)=0.5*(T(1)-T(2))
      PSS(3,NXYC,NZC)=0.5*(T(2)-T(3))
      ENRM(1,NXYC,NZC)=(SNRM(1,NXYC,NZC)-VLAY*(SNRM(2,NXYC,NZC)+SN
1     RM(3,NXYC,NZC)))/ELAY
      ENRM(2,NXYC,NZC)=(SNRM(2,NXYC,NZC)-VLAY*(SNRM(1,NXYC,NZC)+SN
1     RM(3,NXYC,NZC)))/ELAY
      ENRM(3,NXYC,NZC)=(SNRM(3,NXYC,NZC)-VLAY*(SNRM(1,NXYC,NZC)+SN
1     RM(2,NXYC,NZC)))/ELAY
      ESHR(1,NXYC,NZC)=SSC*SSHR(1,NXYC,NZC)
      ESHR(2,NXYC,NZC)=SSC*SSHR(2,NXYC,NZC)
      ESHR(3,NXYC,NZC)=SSC*SSHR(3,NXYC,NZC)
      PE(1,NXYC,NZC)=(T(1)-VLAY*(T(2)+T(3)))/ELAY
      PE(2,NXYC,NZC)=(T(2)-VLAY*(T(1)+T(3)))/ELAY
      PE(3,NXYC,NZC)=(T(3)-VLAY*(T(1)+T(2)))/ELAY
      PSE(1,NXYC,NZC)=SSC*PSS(1,NXYC,NZC)
      PSE(2,NXYC,NZC)=SSC*PSS(2,NXYC,NZC)
      PSE(3,NXYC,NZC)=SSC*PSS(3,NXYC,NZC)
110    CONTINUE
120    CONTINUE
      RETURN
C
      END subroutine ELOUT
C*****
C
      SUBROUTINE ELSMTX (H,U,N,IVEC)
CC
C     ELSMTX - SYMMETRIC MATRIX ROUTINE FOR ELOUT.
C
      DIMENSION H(3,3),U(3,3),W(3),IQ(3)
C
      AN=N
      NM1=N-1
      IF (IVEC-1) 60,10,60
10    DO 50 I=1,N

```

```

        DO 40 J=1,N
          IF (I-J) 30,20,30
20       U(I,J)=1.0
          GO TO 40
30       U(I,J)=0.0
40       CONTINUE
50       CONTINUE
60       DO 90 I=1,NM11
          W(I)=0.0
          IPL1=I+1
          DO 80 J=IPL1,N
            IF (W(I)-ABS(H(I,J))) 70,70,80
70         W(I)=ABS(H(I,J))
            IQ(I)=J
80         CONTINUE
90       CONTINUE
C
C       XMAX SET EQUAL TO ZERO TO AVOID AN IRRELEVANT COMPILER
C       DIAGNOSTIC.
C
          XMAX = 0.0
          DO 120 I=1,NM11
C
          IF (I-1) 110,110,100
100      IF (XMAX-W(I)) 110,120,120
C
110      XMAX=W(I)
          IPIV=I
          JPIV=IQ(I)
120     CONTINUE
          IF (XMAX-1.E-12/AN) 190,190,130
130     Z=H(IPIV,IPIV)-H(JPIV,JPIV)
C
C       Y=2.DO*H(IPIV,JPIV) ***
C       TA=Y/(DABS(Z)+DSQRT(Z*Z+Y*Y)) ***
C       IF(Z.LT.0.0 TA) TA=-TA ***
C       CO=1.DO/DSQRT(1.DO+TA*TA) ***
          Y=2.0*H(IPIV,JPIV)
          TA=Y/(ABS(Z)+SQRT(Z*Z+Y*Y))
          IF (Z) 140,150,150
140     TA=-TA
150     CO=1.0/SQRT(1.0+TA*TA)
C
          SI=TA*CO
          HII=H(IPIV,IPIV)
          HJJ=H(JPIV,JPIV)
          HIJ=H(IPIV,JPIV)
          DO 160 K=1,N
            HTE=H(K,IPIV)
            H(K,IPIV)=H(K,IPIV)*CO+H(K,JPIV)*SI
            H(K,JPIV)=H(K,JPIV)*CO-HTE*SI
            H(IPIV,K)=H(K,IPIV)
160     H(JPIV,K)=H(K,JPIV)
          H(IPIV,IPIV)=0
          H(JPIV,JPIV)=0
          AA=HIJ*TA
          H(IPIV,IPIV)=HII+AA
          H(JPIV,JPIV)=HJJ-AA
          IF (IVEC) 60,60,170
170     DO 180 K=1,N
          UTE=U(K,IPIV)
          U(K,IPIV)=U(K,IPIV)*CO+U(K,JPIV)*SI
180     U(K,JPIV)=U(K,JPIV)*CO-UTE*SI
          GO TO 60
190     RETURN
C
          END subroutine ELSMTX
C*****
C
          SUBROUTINE ELSYM5

```

```

        use C_ELSYS
        use C_ELCOM
        use C_ELCTL
        use C_ELCYLN
        use C_ELPART
        use C_BLANK
CC
C   ELSYM5 - FIVE LAYER ELASTIC PAVEMENT SYSTEM SYMULATION.
C
C   THIS SUBROUTINE WAS ADAPTED FROM THE ELSYM5 COMPUTER
C   PROGRAM, VERSION 3.1, WRITTEN BY GALE AHLBORN, ITTE, UNIVER-
C   SITY OF CALIFORNIA AT BERKELEY. ELSYM5 IS BASED ON LAYER,
C   THE ORIGINAL ELASTIC LAYER PROGRAM, WHICH WAS DEVELOPED BY
C   CHEVRON.
C
C   COMMUNICATION BETWEEN THIS ROUTINE AND ITS CALLER IS
C   THROUGH THE /ELSYS/ AND /ELCOM/ COMMON BLOCKS. THE ENTRY
C   AND EXIT CONDITIONS ARE DESCRIBED IN THE COMMENTS WHICH
C   ACCOMPANY THESE COMMON BLOCKS.
C
C   /ELCTL/ - ELSYM5 CONTROL SWITCHES.
C
C   KSW1 = 1 IF UNDERLYING BASE IS ELASTIC,
C         = 2 IF RIGID UNDERLYING BASE.
C   KSW2 = 1 FOR FULL FRICTION RIGID BASE INTERFACE,
C         = 2 FOR NO FRICTION RIGID BASE INTERFACE,
C   KSW3 = 1 IF CURRENT RADIAL POINT NOT BENEATH LOAD,
C         = 2 IF CURRENT POINT DIRECTLY UNDER LOAD.
C   KSW4 = 1 IF CURRENT DEPTH NOT AT SURFACE,
C         = 2 IF CURRENT DEPTH AT SURFACE.
C   NGQP = NUMBER OF GAUSSIAN QUADRATURE POINTS.
C   NI    = NUMBER OF INTERFACES BETWEEN LAYERS.
C   NLSW  = 3 FOR ONE ELASTIC LAYER,
C         = 2 FOR TWO ELASTIC LAYERS,
C         = 1 FOR THREE OR MORE ELASTIC LAYERS.
C
C   ! COMMON /ELCTL/ KSW1, KSW2, KSW3, KSW4, NBZ, NEI, NEX, NGQP
C   !               , NI, NLSW, NTEST, NTSI, NX, WRL
CC
C   /ELCYLN/ - ELSYM5 CYLINDRICAL COORDINATE VARIABLES.
C
C   NRC = INDEX OF CURRENT RADIAL DISTANCE IN R.
C   NZC = INDEX OF CURRENT DEPTH IN Z.
C   LAY = LAYER IN WHICH POINT IS LOCATED.
C   NR  = NUMBER OF RADIAL DISTANCES AT WHICH CALCULATIONS
C         MUST BE MADE.
C   R   = ARRAY OF DISTANCES BETWEEN LOADS AND XY POINTS IN
C         ASCENDING ORDER WITH DUPLICATE VALUES REMOVED.
C   IXR = ARRAY OF POINTERS TO THE ELEMENT IN R WHICH GIVES THE
C         DISTANCE FROM EACH XY POINT TO EACH LOAD.
C   ANS = ARRAY OF CALCULATED RESPONSES AT EACH DEPTH AND
C         FOR EACH RADIAL DISTANCE.
C   RLP = RADIUS OF LOAD * PRESSURE.
C   WR  = CURRENT RADIAL DISTANCE.
C   WZ  = CURRENT DEPTH.
C
C   ! COMMON /ELCYLN/ NRC,NZC,LAY,NR,R(60),IXR(60),ANS(6,60,10)
C   !               , RSE, TSE, VSE, SSE, RDP, VDP, RLP, WR, WZ, LAY12
CC
C
C   BLANK COMMON - USED AS WORKING STORAGE BY INPUT AND BY ELSYM5.
C
C   ! COMMON ST1, ST2, ST3, ST4, TST1, TST2, TST3, TST4
C   !               , CDAB(5,736), AJ1(184), RJ0(184), RJ1(184), EX(32)
CC
C   /ELPART/ - PARTITION USED FOR NUMERICAL INTEGRATION.
C
C   ! COMMON /ELPART/ GP(184)
CC

```

```

C
C /ELSYS/ - ELASTIC LAYERED SYSTEM DESCRIPTION.
C
C
C THE FOLLOWING INFORMATION MUST BE PROVIDED BEFORE ELSYM5 IS
C CALLED, THESE LOCATIONS ARE NOT DISTURBED.
C
C NEL = NUMBER OF ELASTIC LAYERS.
C E = ARRAY OF MODULI FOR THE LAYERS.
C V = ARRAY OF POISSON/S RATIOS FOR THE LAYERS.
C TH = ARRAY OF THICKNESS FOR THE LAYERS.
C TH(NEL) = 0.0 IF ELASTIC HALFSpace,
C = DISTANCE TO RIGID BASE INTERFACE OTHERWISE.
C CI = 2HFF IF FULL FRICTION RIGID BASE INTERFACE,
C = 2HNF IF NO FRICTION RIGID BASE INTERFACE.
C (IGNORED IF TH(NEL) = 0.0)
C
C ON EXIT FROM ELSYM5 THE FOLLOWING INFORMATION IS AVAILABLE.
C
C DI = DEPTHS OF THE INTERFACES BETWEEN LAYERS.
C
C ! COMMON /ELSYS/ NEL, E(5), V(5), TH(5), CI, DI(5)
CC
C
C /ELCOM/ - ELSYM5 COMMUNICATIONS BLOCK.
C
C
C THE FOLLOWING INFORMATION MUST BE PROVIDED BEFORE ELSYM5 IS
C CALLED, THESE LOCATIONS ARE NOT DISTURBED.
C
C FOR = LOAD FORCE (POUNDS).
C PRES = LOAD PRESSURE (PSI).
C NLD = NUMBER OF LOADS.
C XL = ARRAY OF X COORDINATES (IN).
C YL = ARRAY OF Y COORDINATES (IN).
C NXY = NUMBER OF XY POINTS FOR RESULTS.
C NZ = NUMBER OF DEPTHS FOR RESULTS.
C XP = ARRAY OF X COORDINATES FOR RESULTS (IN).
C YP = ARRAY OF Y COORDINATES FOR RESULTS (IN).
C Z = ARRAY OF DEPTHS FOR RESULTS (IN).
C
C
C ON EXIT FROM ELSYM5 THE FOLLOWING INFORMATION IS AVAILABLE.
C
C RL = RADIUS OF ASSUMED CIRCULAR LOADS (IN).
C LAYZ = ARRAY OF LAYERS IN WHICH Z VALUES FALL.
C
C THE FOLLOWING ARRAYS ARE USED TO RETURN THE RESULTS OF THE
C ELASTIC LAYER SOLUTION. THEY ARE TRIPLY-DIMENSIONED, THE
C INDICES ARE:
C 1ST INDEX = DIRECTION OF RESPONSE. (FOR PRINCIPAL
C STRESSES AND STRAINS: 1, 2, 3; OTHER
C RESPONSES ARE CODED: 1=X, 2=Y, 3=Z)
C 2ND INDEX = INDEX OF XY POSITION IN XP AND YP.
C 3RD INDEX = INDEX OF DEPTH IN Z.
C
C SNRM = NORMAL STRESSES.
C SSHR = SHEAR STRESSES.
C PS = PRINCIPAL STRESSES.
C PSS = PRINCIPAL SHEAR STRESSES.
C DISP = DISPLACEMENTS.
C ENRM = NORMAL STRAINS.
C ESHR = SHEAR STRAINS.
C PE = PRINCIPAL STRAINS.
C PSE = PRINCIPAL SHEAR STRAINS.
C
C ! COMMON /ELCOM/ FOR, PRES, RL, NLD, XL(10),YL(10), NXY, NZ
C ! , XP(10),YP(10),Z(10),LAYZ(10)
C ! , SNRM(3,10,10),SSHR(3,10,10),PS(3,10,10)
C ! , PSS(3,10,10), DISP(3,10,10),ENRM(3,10,10)

```

```

!      .      , ESHR(3,10,10),PE(3,10,10), PSE(3,10,10)
C
DATA IFIRST / 0 /
C
C   PERFORM SYSTEM INITIALIZATIONS.
C
IF (IFIRST.EQ.0) CALL ELPRS
IFIRST=1
CALL ELINIT
C
C   CALCULATE COEFFICIENTS OF THE SYSTEM ONCE FOR EACH DISTINCT
C   RADIAL DISTANCE FROM A LOAD TO AN XY POINT (USING CYLINDRICAL
C   COORDINATES).
C
IF (NLSW .LT. 3) GO TO 20
10 CALL ELSNGL
GO TO 50
20 CALL ELPCC
30 K4=1
K1=1
DO 40 K2=1,NBZ
DO 40 K3=1,NGQP
FM=GP(K1)/WRL
CALL ELDEVL (FM)
CALL ELMULT (FM)
CALL ELBKS (FM,K4)
K1=K1+1
K4=K4+4
40 CONTINUE
50 K1=1
RLDWRL=RL/WRL
DO 60 K2=1,NBZ
DO 60 K3=1,NGQP
X=GP(K1)*RLDWRL
AJ1(K1)=BESSEL(X,1)
K1=K1+1
60 CONTINUE
IF (KSW3 .EQ. 1) GO TO 80
70 NTEST=2
GO TO 120
80 K1=1
WRDWRL=WR/WRL
DO 90 K2=1,NBZ
DO 90 K3=1,NGQP
X=GP(K1)*WRDWRL
RJ0(K1)=BESSEL(X,0)
RJ1(K1)=BESSEL(X,1)
K1=K1+1
90 CONTINUE
IF (WR-RL) 100,100,110
100 NTEST=RL/WR+0.0001
GO TO 120
110 NTEST=WR/RL+0.0001
120 NTEST=NTEST+1
IF (NTEST-10) 140,140,130
130 NTEST=10
140 NTSI=NTEST+1
C
C   CALCULATE RESPONSES AT EACH DEPTH FOR CURRENT RADIAL DISTANCE.
C
DO 200 K1=1,NZ
KSW4=1
NZC=K1
WZ=Z(NZC)
IF (WZ.EQ.0.0) KSW4=2
C
C   DETERMINE LAYER IN WHICH CURRENT
C   DEPTH POINT RESIDES.
IF (NLSW .LT. 3) GO TO 160
150 LAY=1
GO TO 190
160 DO 180 K2=1,NEI

```

```

        IF (WZ-(DI(K2)+0.001)) 170,170,180
170     LAY=K2
        GO TO 190
180     CONTINUE
        LAY=NEL
190     LAYZ(NZC)=LAY
        CALL ELCALC
        CALL ELSRP
200    CONTINUE
        KSW3=1
        NRC=NRC+1
        IF (NRC.GT.NR) GO TO 210
        WR=R(NRC)
        IF (WR.LE.RL) GO TO 80
        WRL=WR
        IF (NLSW - 2) 30,30,10
C
C     RETURN ANSWERS TO CALLER.
C
210    CALL ELOUT
        RETURN
C
        END subroutine ELSYM5

end module ELSYM5_Program

```

E.5.7 Data Modules of ELSYM5_Program

```
!----- data module: C_BLANK -----
  module C_BLANK

    COMMON ST1, ST2, ST3, ST4, TST1, TST2, TST3, TST4
    .      , CDAB(5,736), AJ1(184), RJ0(184), RJ1(184), EX(32)

  end module C_BLANK
!-----

!----- data module: C_CONST -----
  module C_CONST

    COMMON /CONST/ ICD,IPR,DUM(19)

  end module C_CONST
!-----

!----- data module: C_DEPTH -----
  module C_DEPTH

    COMMON /DEPTH/ THK(6), JZ(5), ZVAL(5,5), IWARN, IZ, LNUM(5)

  end module C_DEPTH
!-----

!----- data module: C_ELCOEF -----
  module C_ELCOEF

    COMMON /ELCOEF/
  1 EI(16,2,2),S(2,2,2),SV(4,9),ISC(4),SA(2,2),RB(2,2),BA(2,2,2),
  2 TB1,TB2,TB3,TB4,TB5,
  3 NE,NEXD2,NEIM1

  end module C_ELCOEF
!-----

!----- data module: C_ELCOM -----
  module C_ELCOM

    COMMON /ELCOM/ FOR, PRES, RL, NLD, XL(10),YL(10), NXY, NZ
    .      , XP(10),YP(10),Z(10),LAYZ(10)
    .      , SNRM(3,10,10), SSHR(3,10,10), PS(3,10,10)
    .      , PSS(3,10,10), DISP(3,10,10), ENRM(3,10,10)
    .      , ESHR(3,10,10), PE(3,10,10), PSE(3,10,10)

  end module C_ELCOM
!-----

!----- data module: C_ELCTL -----
  module C_ELCTL

    COMMON /ELCTL/ KSW1, KSW2,KSW3, KSW4, NBZ, NEI, NEX, NGQP,
    .      , NI, NLSW, NTEST, NTSI, NX, WRL

  end module C_ELCTL
!-----

!----- data module: C_ELCYLN -----
  module C_ELCYLN

    COMMON /ELCYLN/ NRC,NZC,LAY,NR,R(60),IXR(60),ANS(6,60,10)
```

```

.          , RSE, TSE, VSE, SSE, RDP, VDP, RLP, WR, WZ, LAY12
end module C_ELCYLN
!-----
!----- data module: C_ELPART -----
module C_ELPART
COMMON /ELPART/ GP(184)
end module C_ELPART
!-----
!----- data module: C_ELSYS -----
module C_ELSYS
COMMON /ELSYS/ NEL, E(5), V(5), TH(5), CI, DI(5)
end module C_ELSYS
!-----
!----- data module: C_RDIN -----
module C_RDIN
COMMON /RDIN/ YYYYY,IVAL,NSY,LCNT,VAL(3),TITLE(20),IVLSVE,SVVAL1,
1 XXXXXX
end module C_RDIN
!-----

```